

TOP VIEW

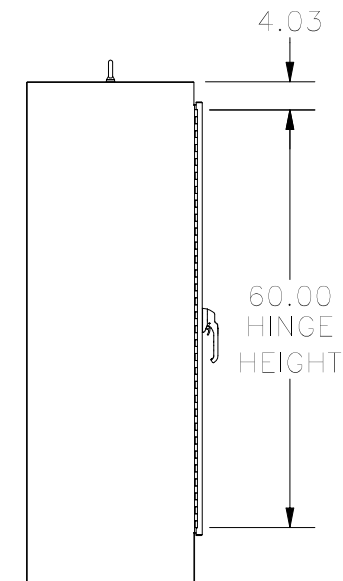

LEFT SIDE VIEW

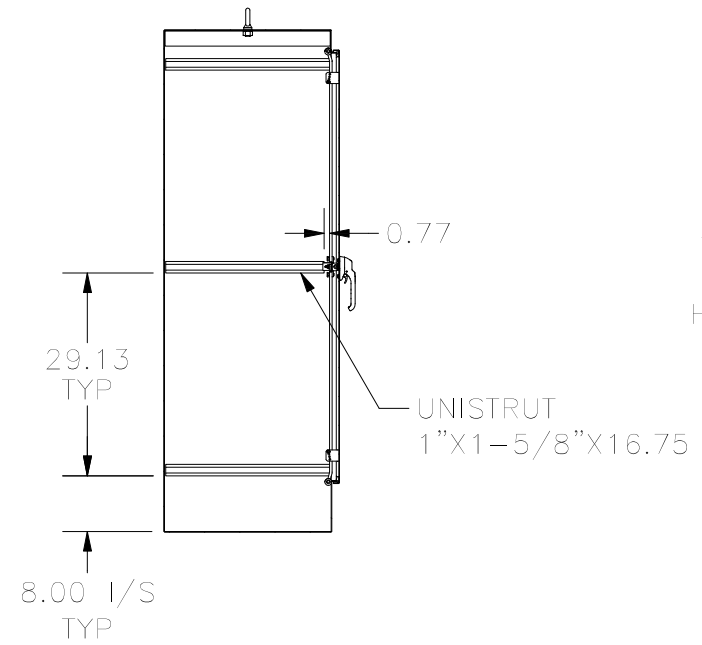

**SECTION A-A
(INSIDE RIGHT VIEW OF ENCLOSURE)**

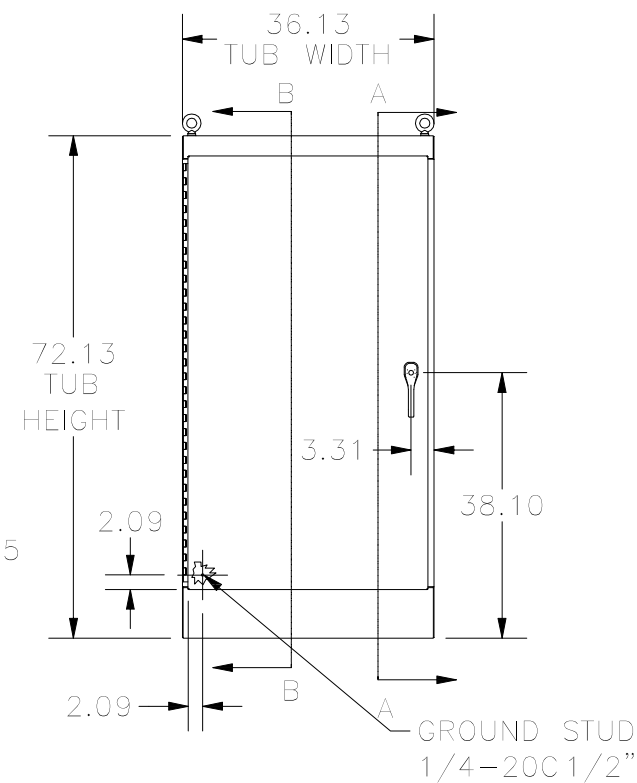

FRONT VIEW

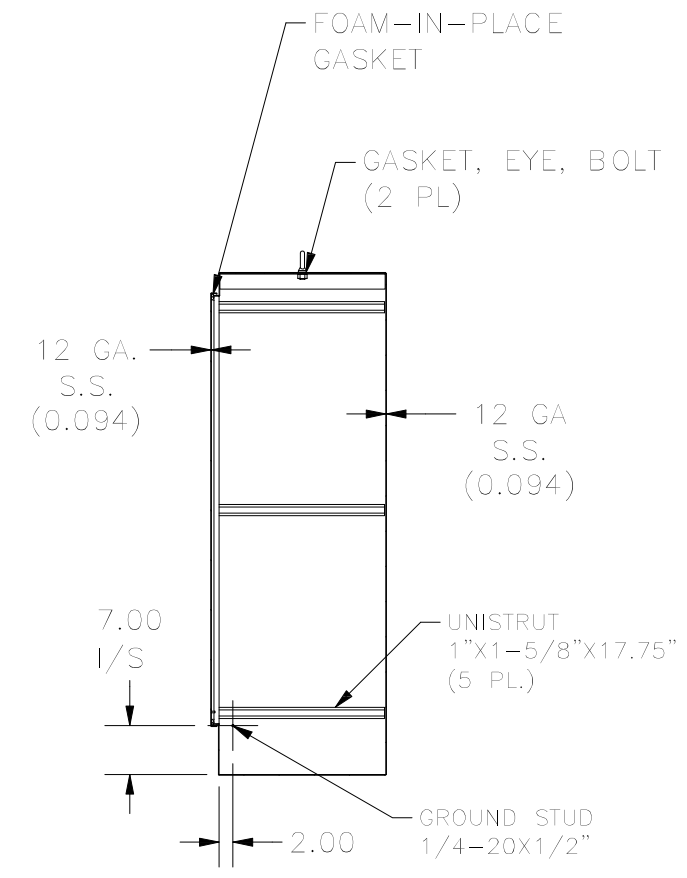

**SECTION B-B
(INSIDE LEFT VIEW OF ENCLOSURE)**

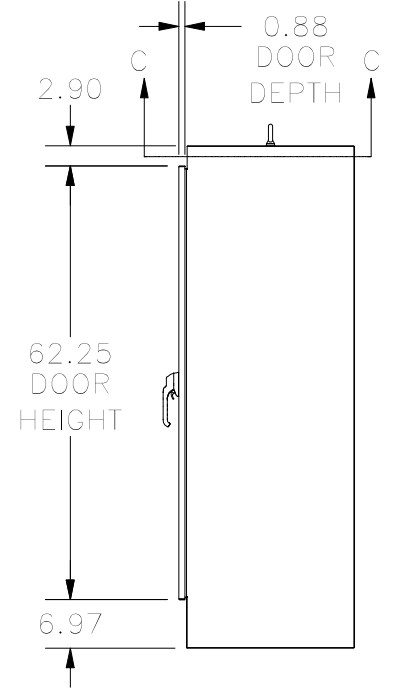

RIGHT SIDE VIEW

PART#: WA723624FSSS
(DATA SUBJECT TO CHANGE WITHOUT NOTICE)

THIS DRAWING IS PROPERTY OF HUBBELL INC. WIEGMANN
ALL INFORMATION IS PROPRIETARY AND NOT TO BE DUPLICATED

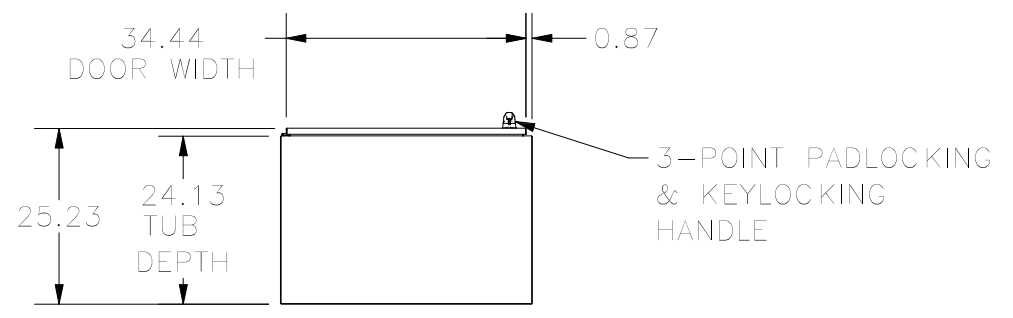

BOTTOM VIEW

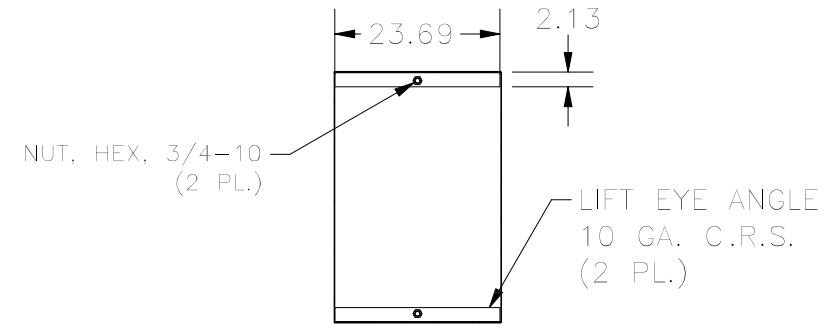

**SECTION C-C
(INSIDE VIEW OF ENCLOSURE)**