

TOP VIEW

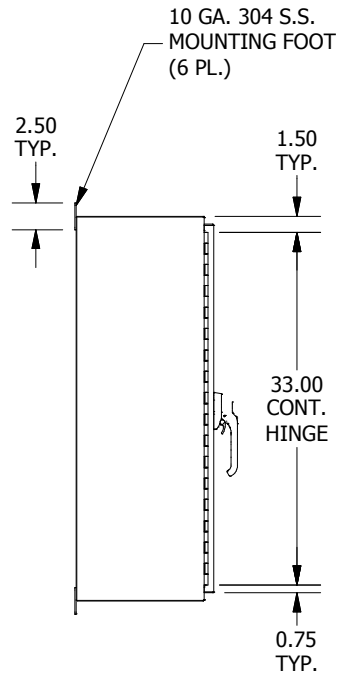

LEFT SIDE VIEW

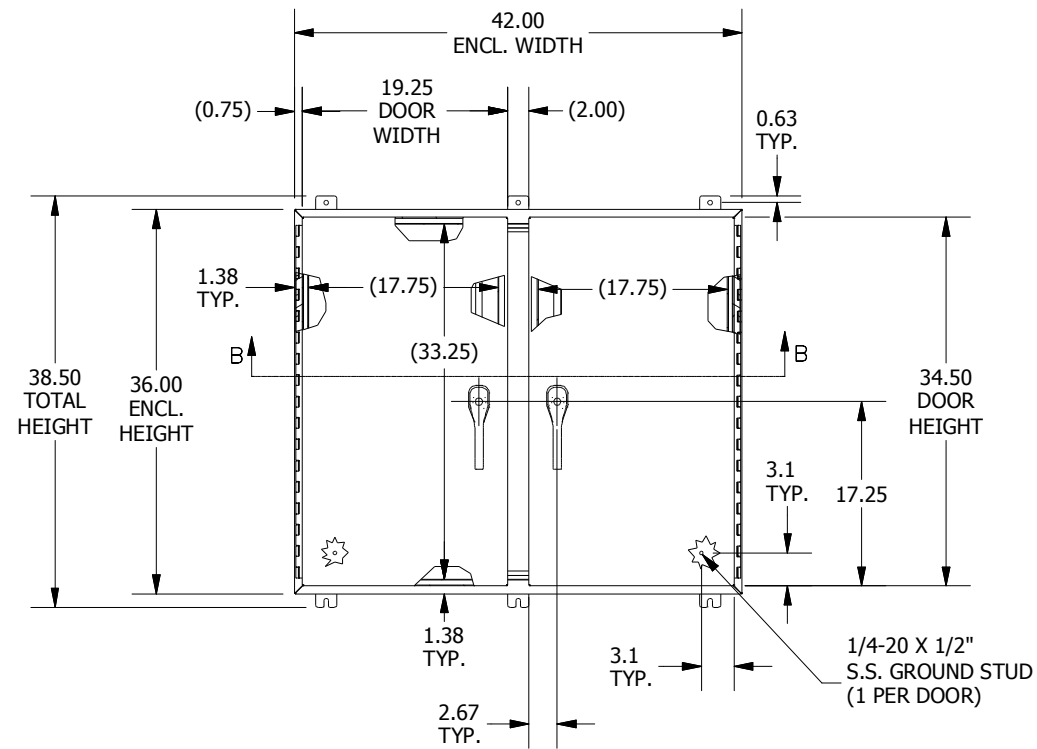

FRONT VIEW

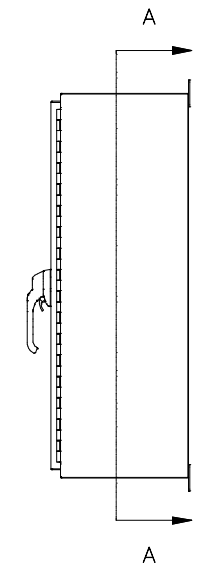

RIGHT SIDE VIEW

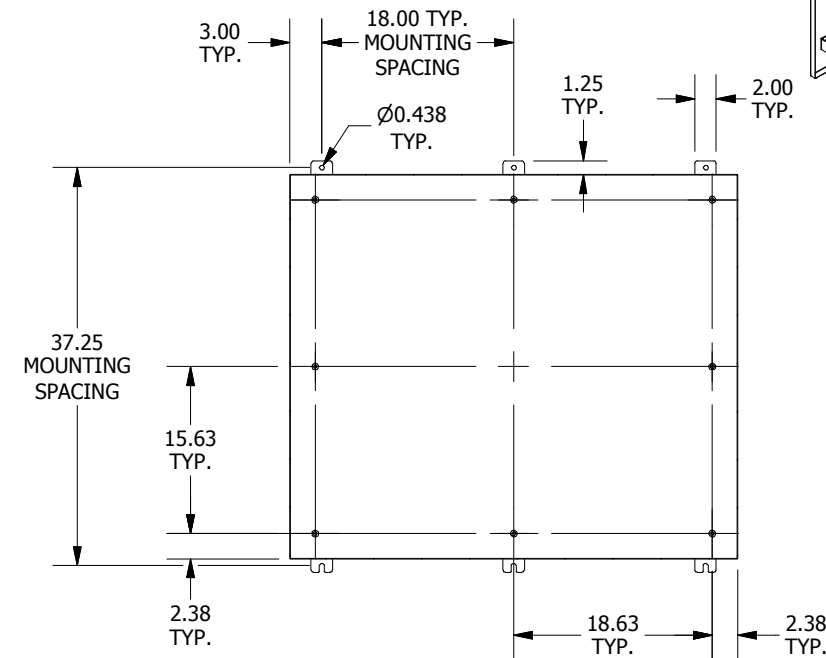

**SECTION A-A
(INSIDE BACK VIEW OF ENCL.)**

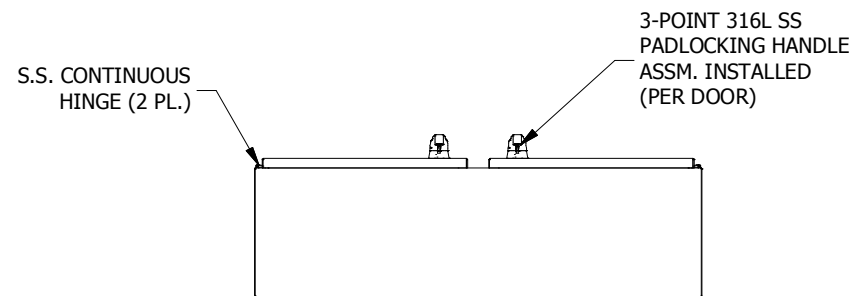
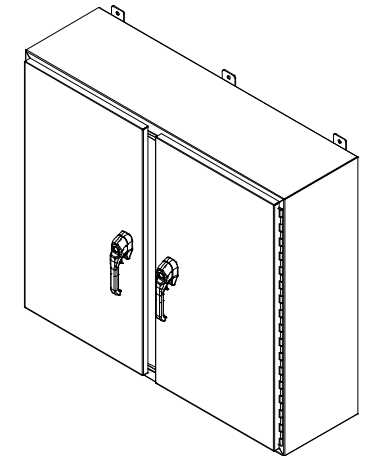
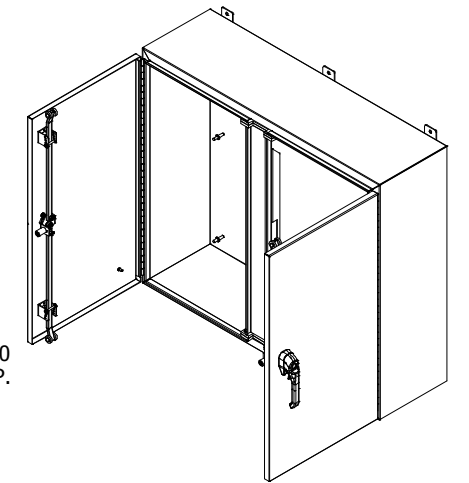

BOTTOM VIEW

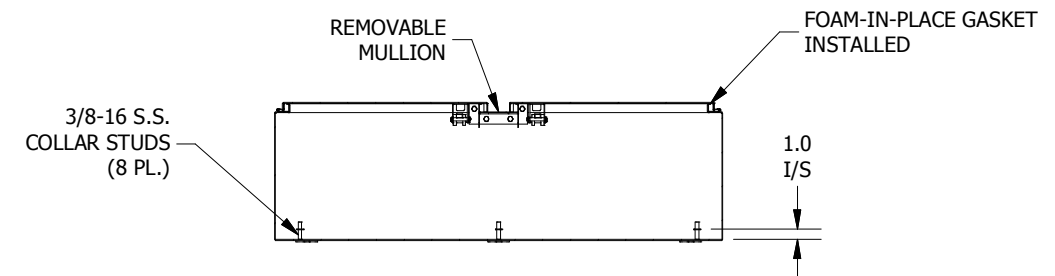

**SECTION B-B
(INSIDE VIEW OF TOP)**

PART#: SSN4364212WF3PT
(DATA SUBJECT TO CHANGE WITHOUT NOTICE)

THIS DRAWING IS PROPERTY OF HUBBELL INC. WIEGMANN
ALL INFORMATION IS PROPRIETARY AND NOT TO BE DUPLICATED