

TOP VIEW

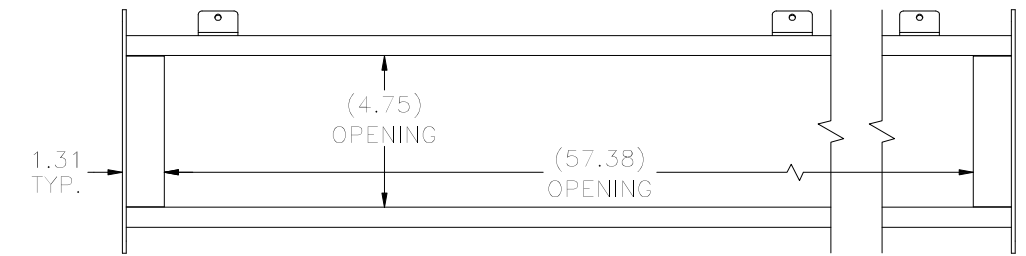

TOP VIEW (LID ASSM. NOT SHOWN)

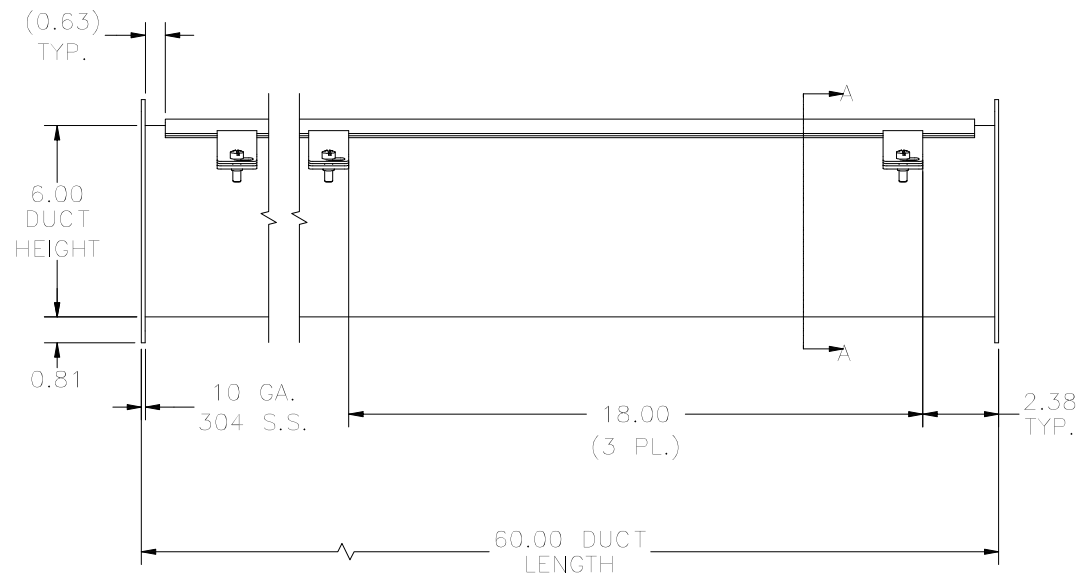

FRONT VIEW

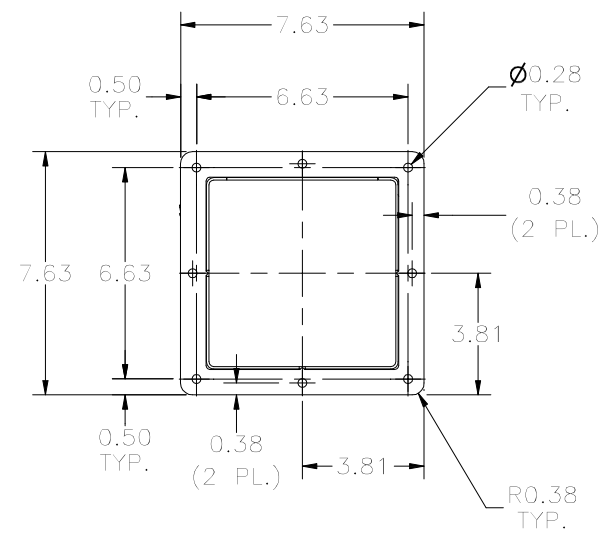

RIGHT SIDE VIEW

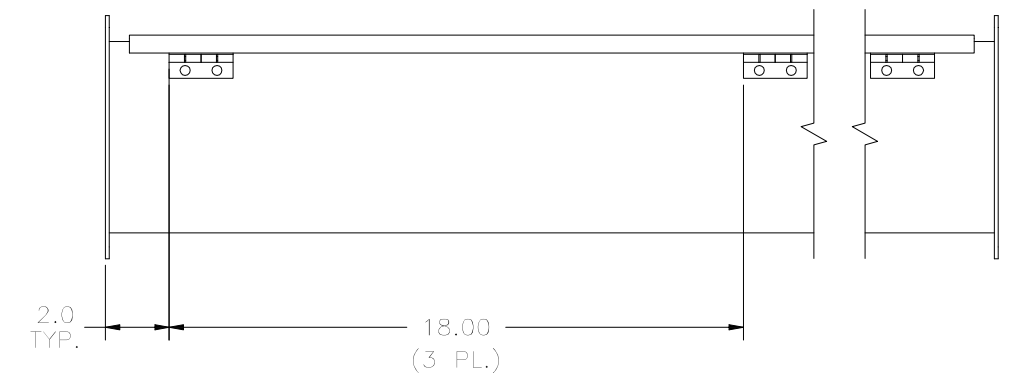

REAR VIEW

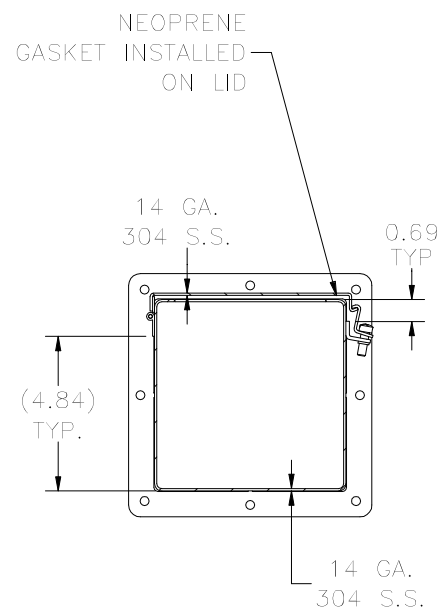

SECTION A-A VIEW



BOTTOM VIEW

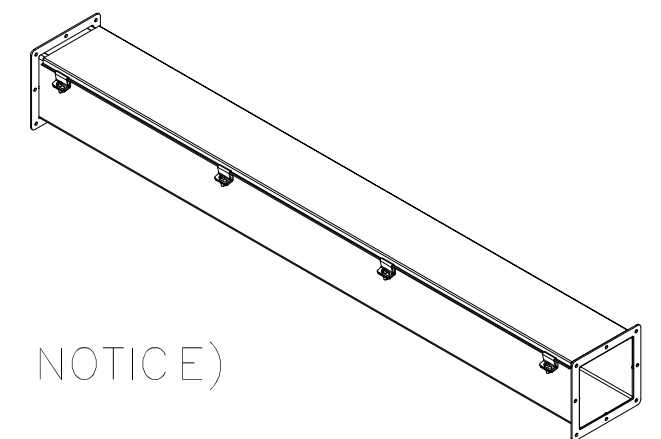

PART#: SSJW65
(DATA SUBJECT TO CHANGE WITHOUT NOTICE)

THIS DRAWING IS PROPERTY OF HUBBELL INC. WEIGMANN
ALL INFORMATION IS PROPRIETARY AND NOT TO BE DUPLICATED