

TOP VIEW

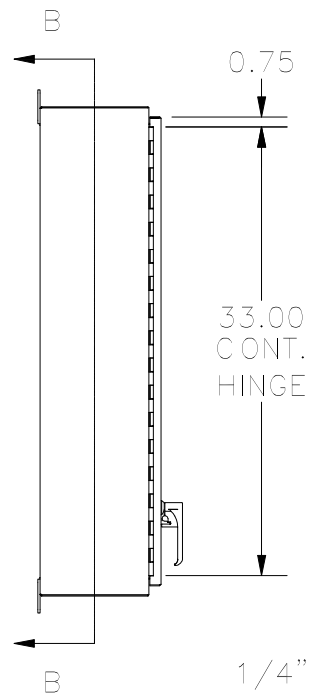

LEFT VIEW

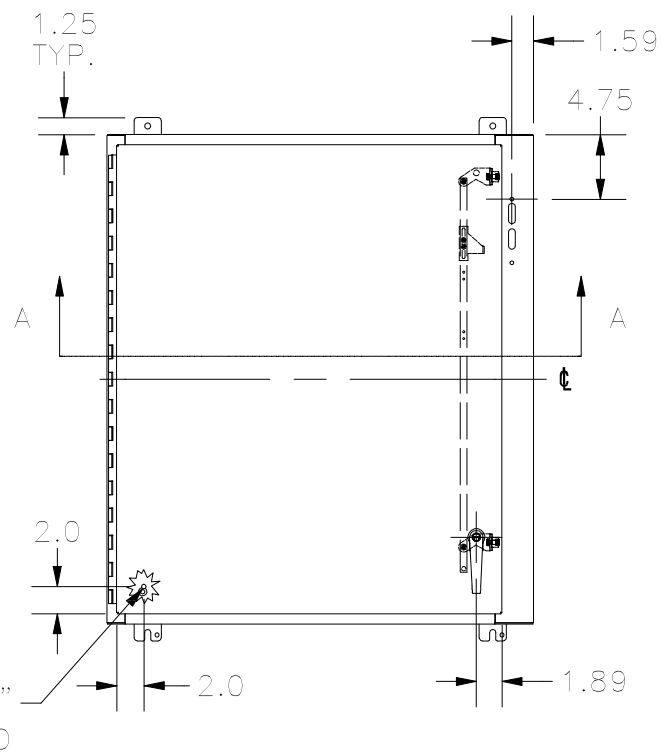

FRONT VIEW

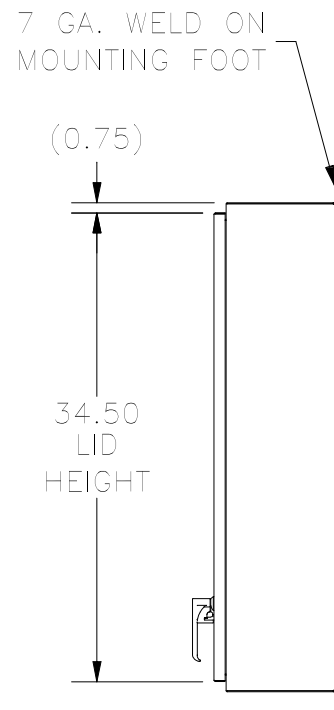

RIGHT VIEW

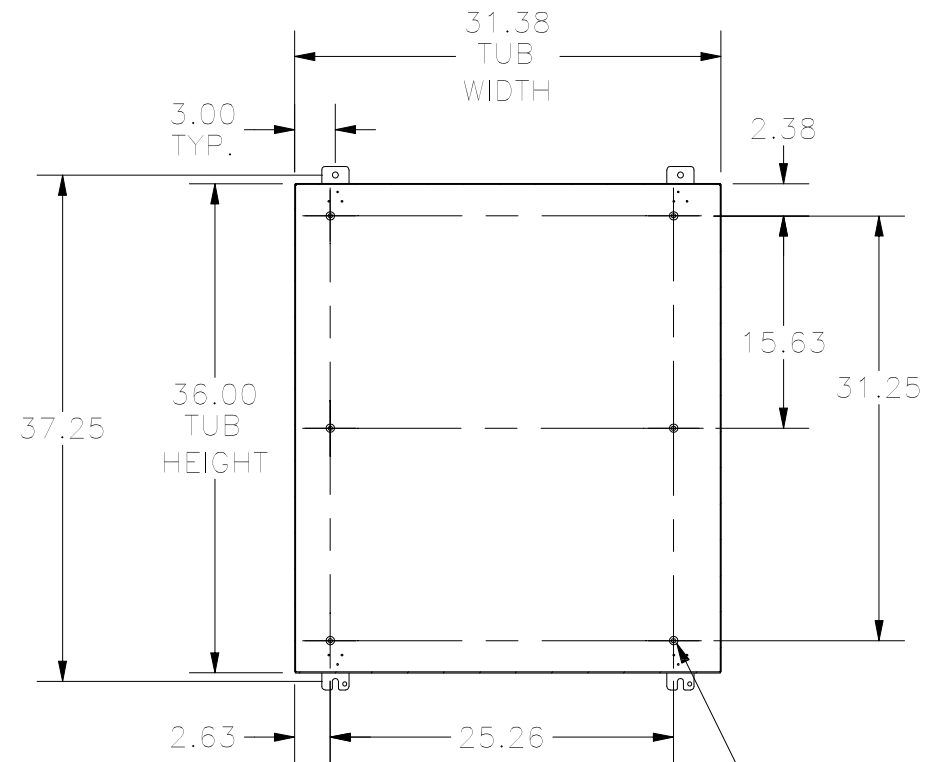

**SECTION B-B
(INSIDE BACK OF ENCLOSURE)**

3/8"-16 X 5/8"
COLLAR STUD
(TYP 6 PL.)

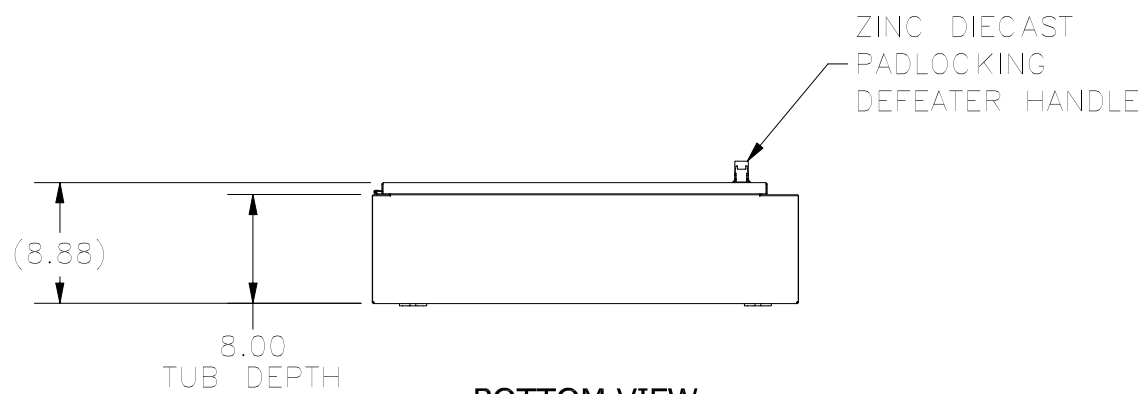

BOTTOM VIEW

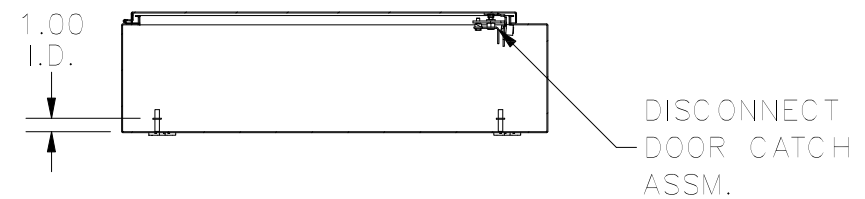

**SECTION A-A
(INSIDE TOP OF ENCLOSURE)**

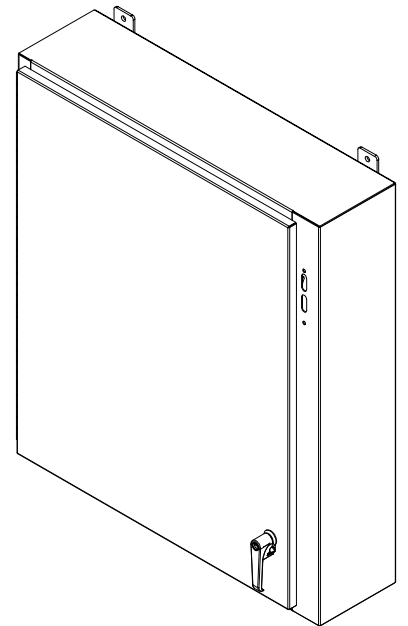

PART#: SDN12363108PL
(DATA SUBJECT TO CHANGE WITHOUT NOTICE)

THIS DRAWING IS PROPERTY OF HUBBELL INC. WIEGMANN
ALL INFORMATION IS PROPRIETARY AND NOT TO BE DUPLICATED