

TOP VIEW

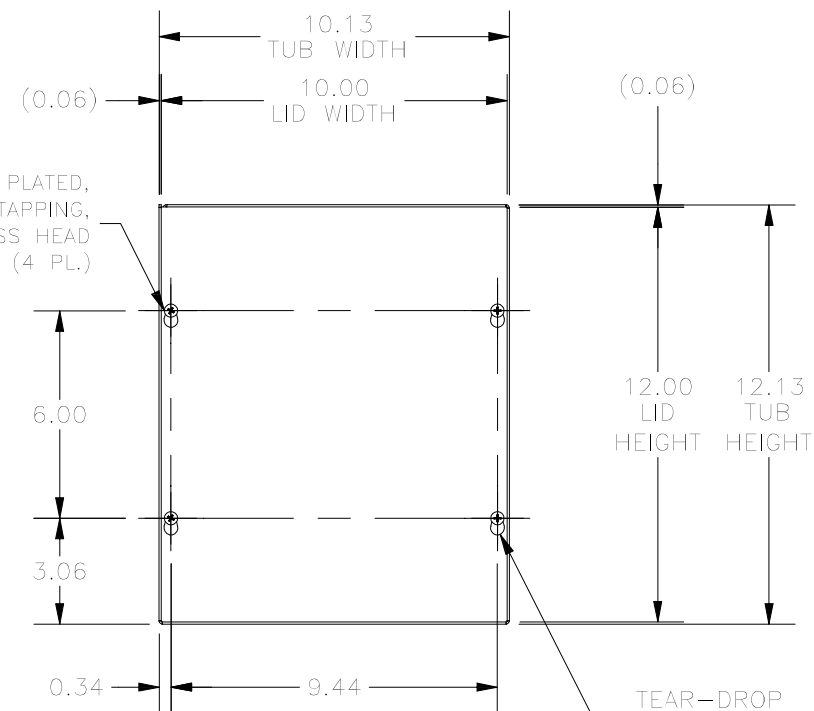

FRONT VIEW

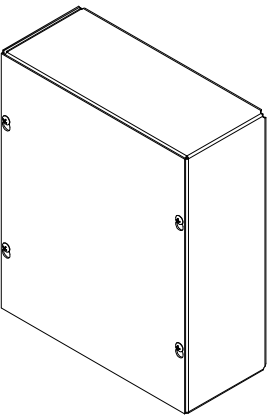
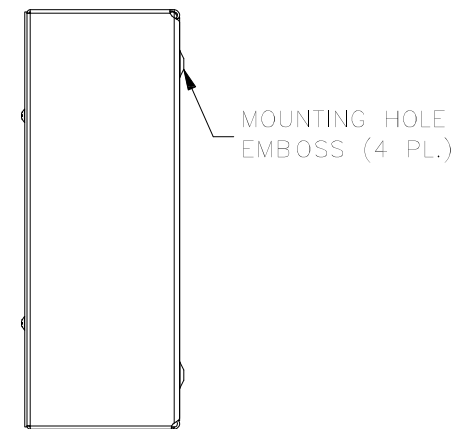

RIGHT SIDE VIEW

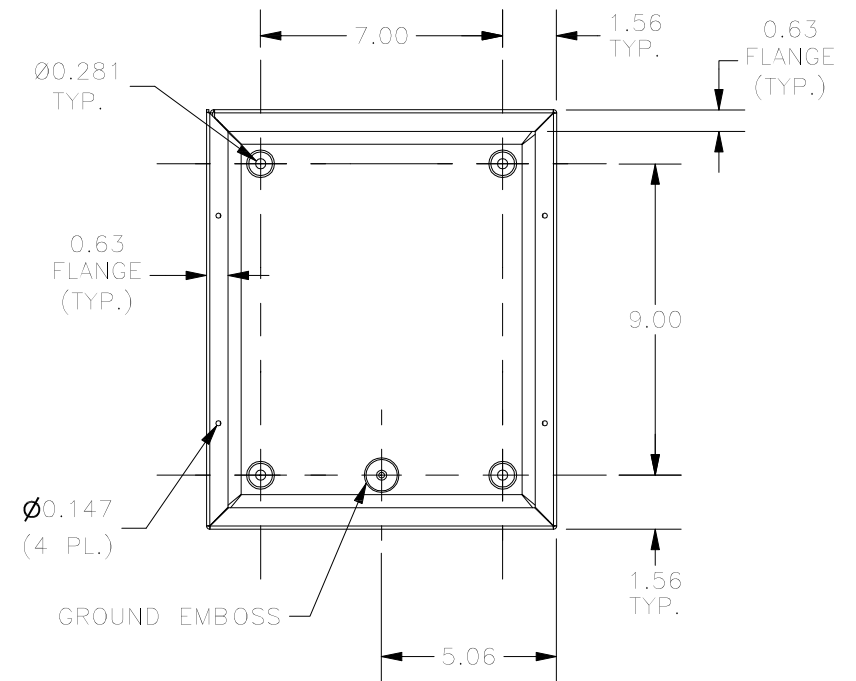

FRONT VIEW LID REMOVED

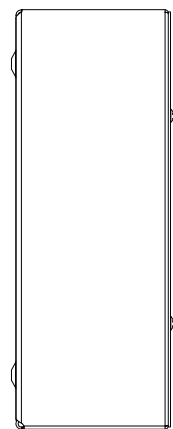

LEFT SIDE VIEW



BOTTOM VIEW

PART#: SC 101204GNK
 (DATA SUBJECT TO CHANGE WITHOUT NOTICE)

THIS DRAWING IS PROPERTY OF HUBBELL INC. WIEGMANN
 ALL INFORMATION IS PROPRIETARY AND NOT TO BE DUPLICATED