

**TOP VIEW**

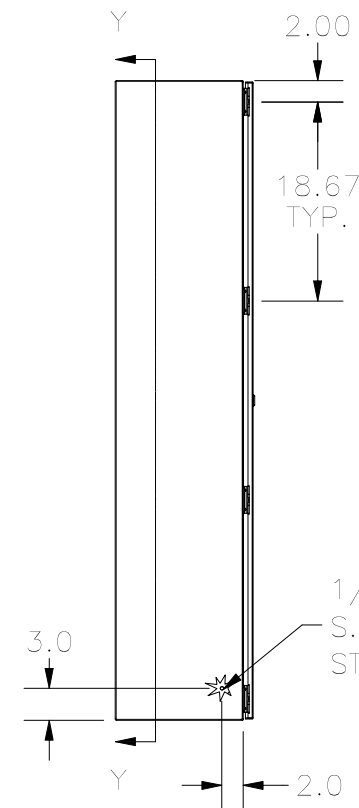

**LEFT SIDE VIEW**

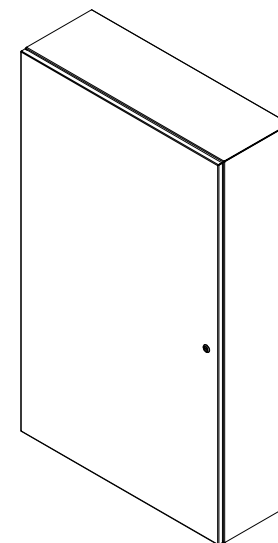
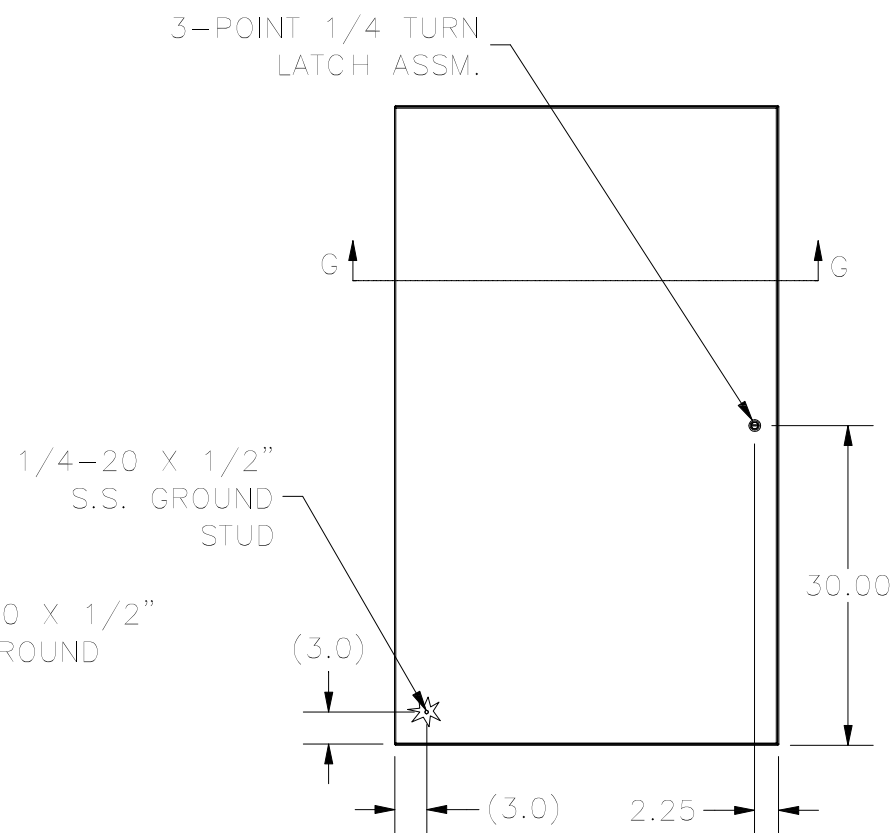

**FRONT VIEW**



**RIGHT SIDE VIEW**

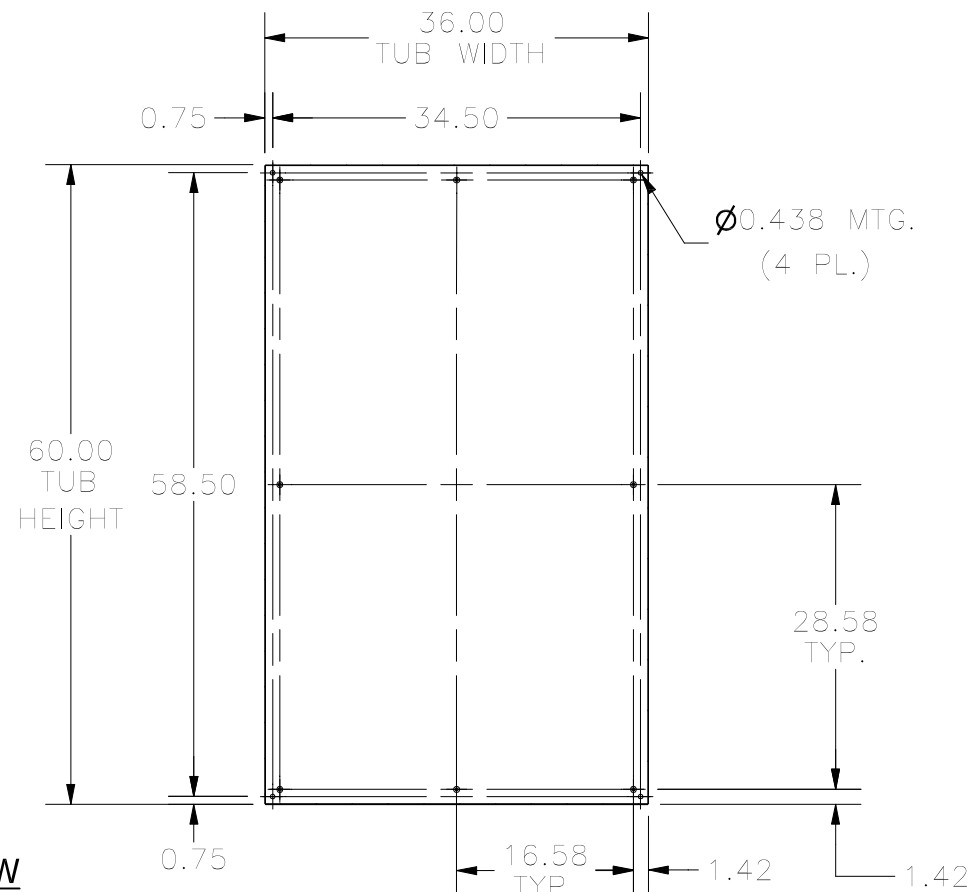

**SECTION Y-Y (INSIDE BACK OF ENCLOSURE)**

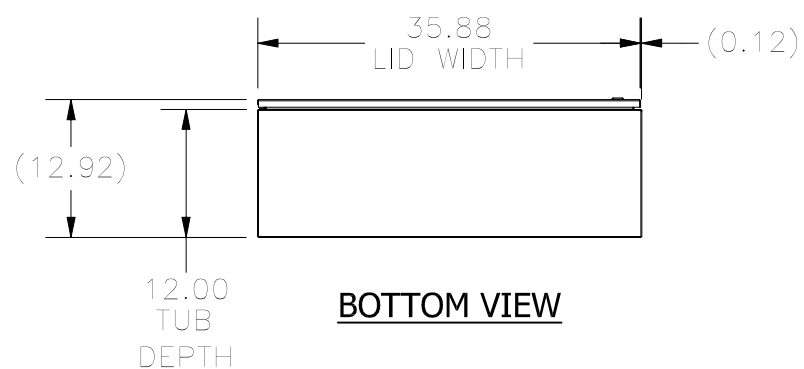

**BOTTOM VIEW**

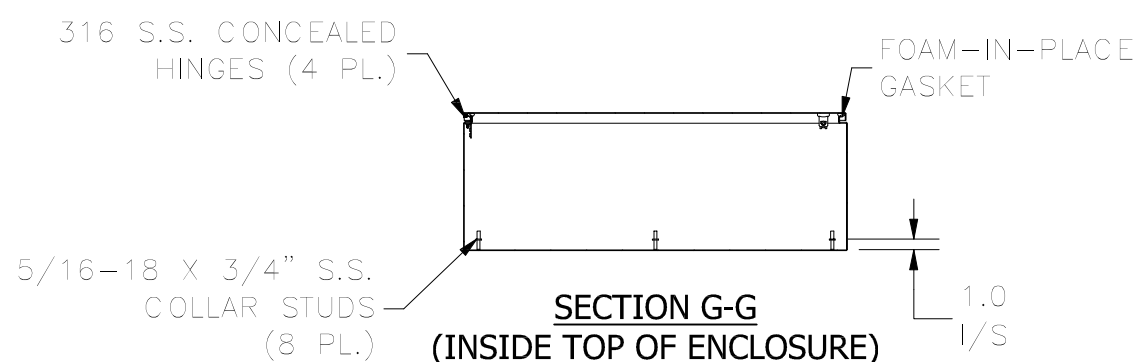

**SECTION G-G (INSIDE TOP OF ENCLOSURE)**

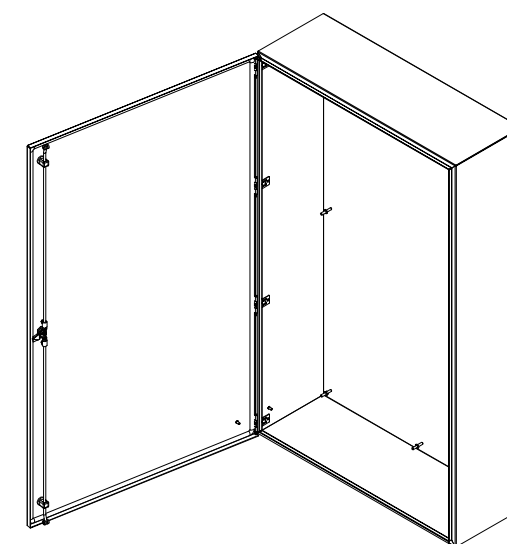

PART #: N412603612SSC  
(DATA SUBJECT TO CHANGE WITHOUT NOTICE.)

THIS DRAWING IS PROPERTY OF HUBBELL INC. WIEGMANN  
ALL INFORMATION IS PROPRIETARY AND NOT TO BE DUPLICATED