

TOP VIEW

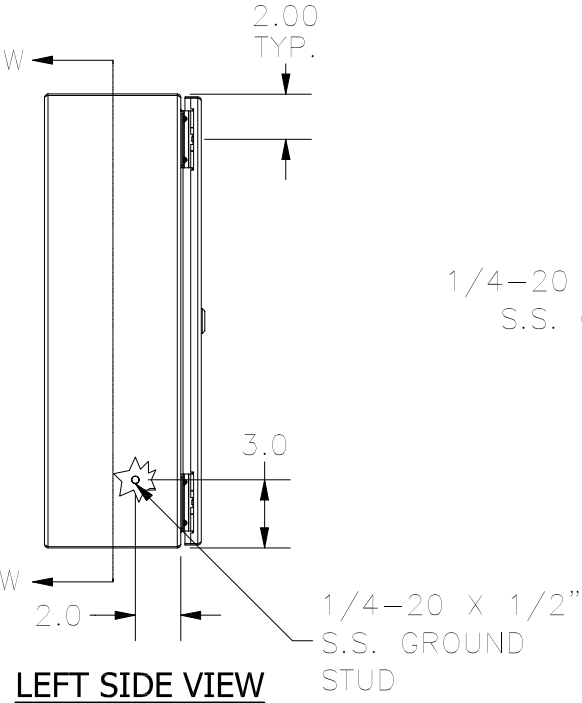

LEFT SIDE VIEW

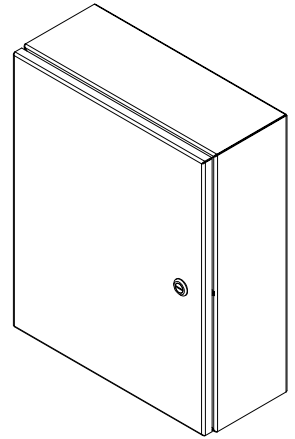
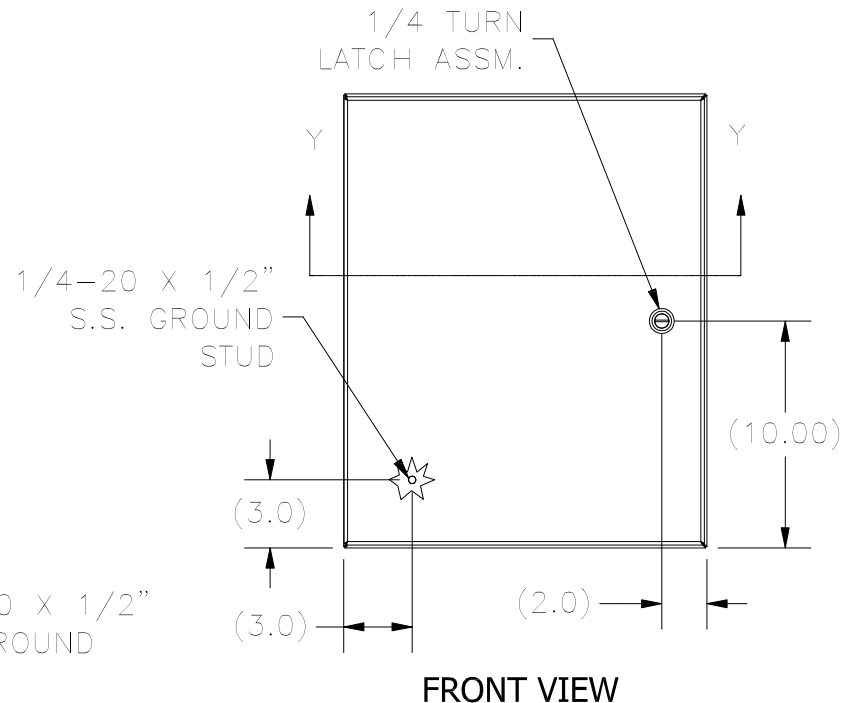

FRONT VIEW



RIGHT SIDE VIEW

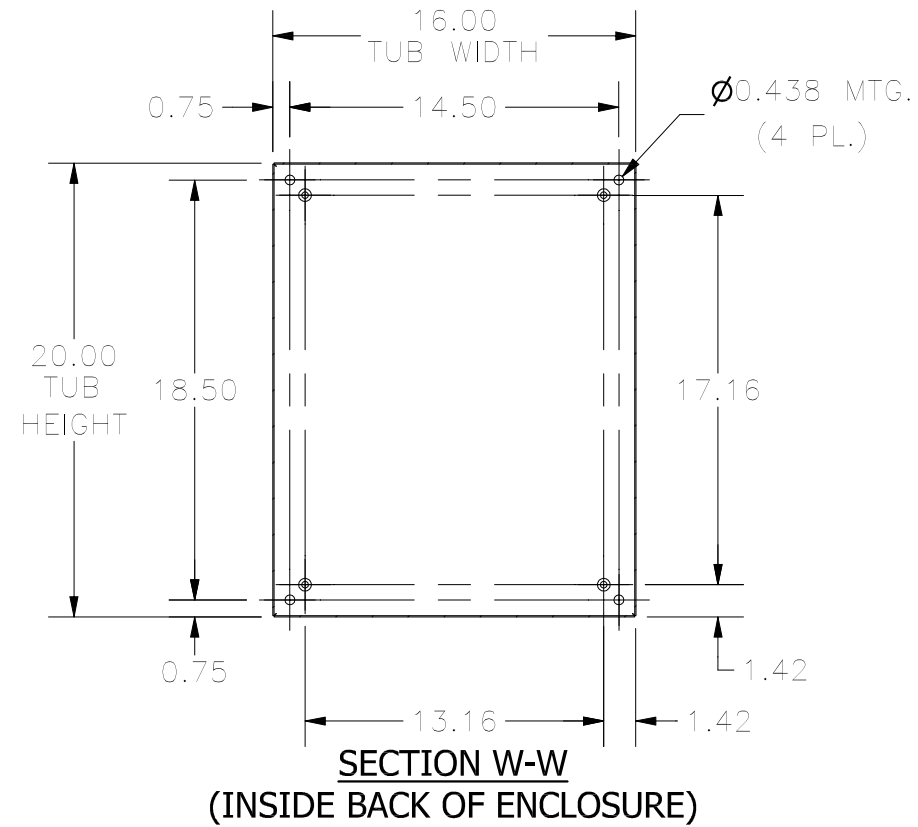

SECTION W-W (INSIDE BACK OF ENCLOSURE)

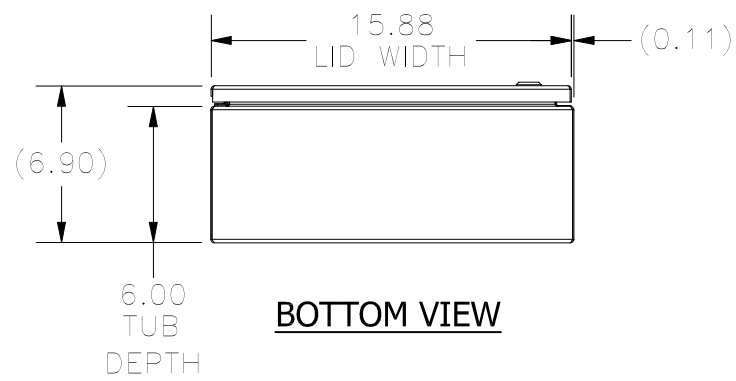

BOTTOM VIEW

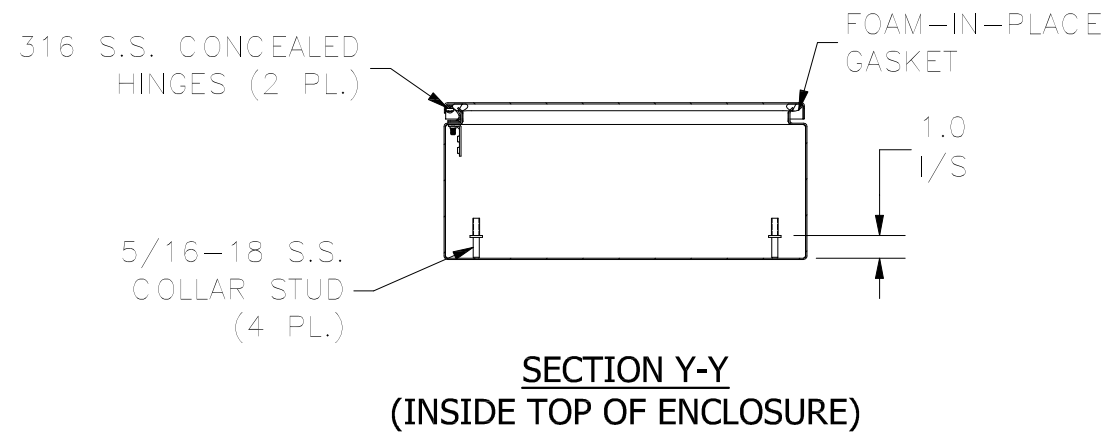

SECTION Y-Y (INSIDE TOP OF ENCLOSURE)

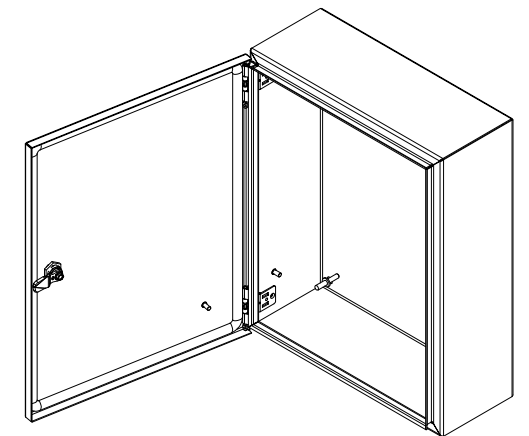

PART #: N412201606SSC
(DATA SUBJECT TO CHANGE WITHOUT NOTICE.)

THIS DRAWING IS PROPERTY OF HUBBELL INC. WIEGMANN
ALL INFORMATION IS PROPRIETARY AND NOT TO BE DUPLICATED