

TOP VIEW

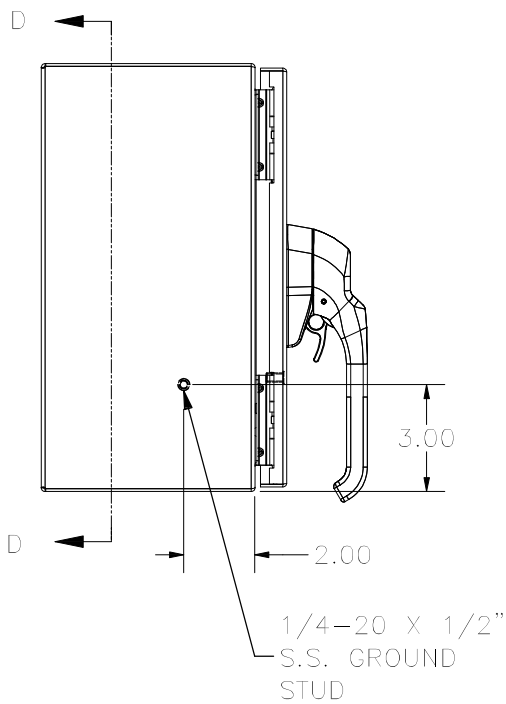

LEFT SIDE VIEW

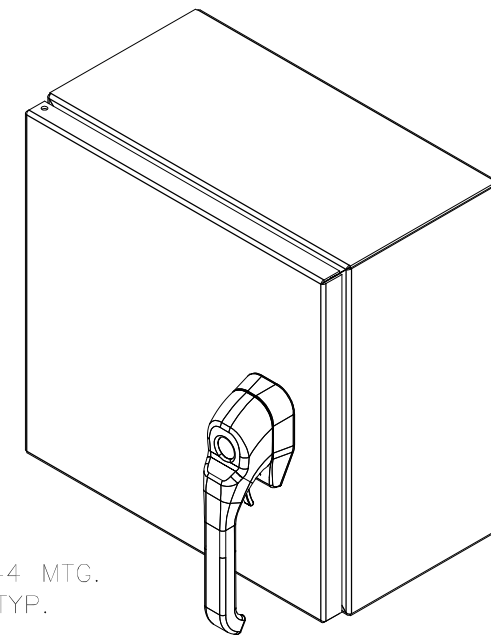
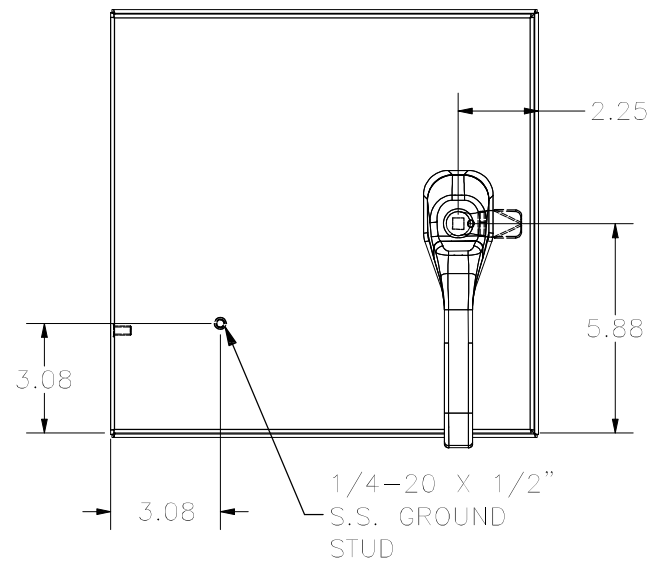

FRONT VIEW

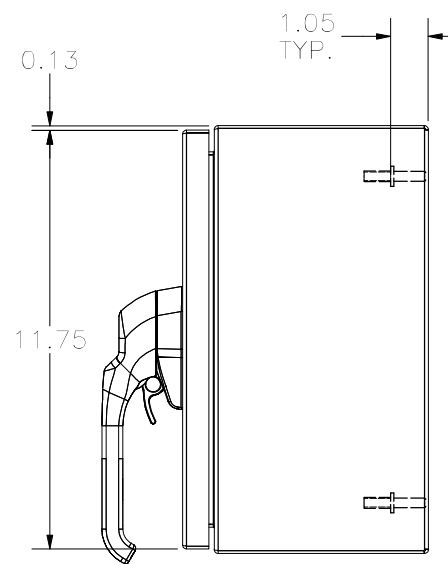

RIGHT SIDE VIEW

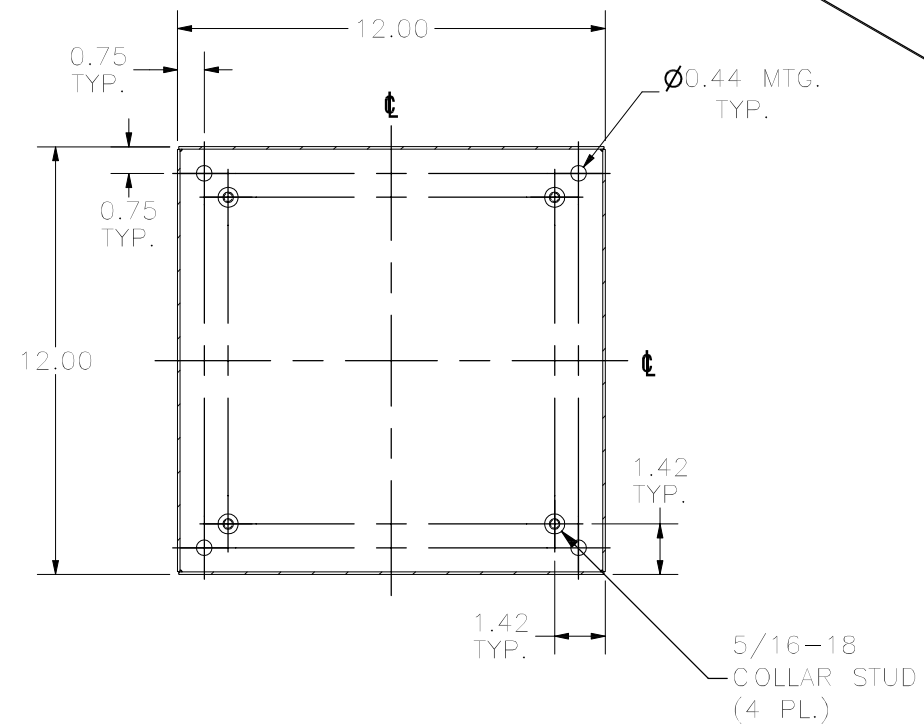

SECTION D-D VIEW
(INSIDE BACK OF ENCLOSURE)

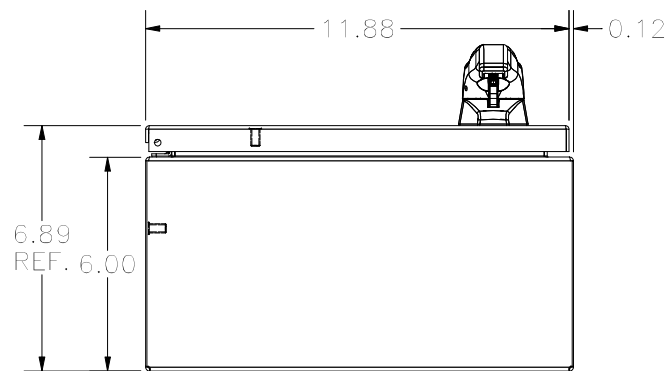

BOTTOM VIEW

PART#: N4121212061PTC
(DATA SUBJECT TO CHANGE WITHOUT NOTICE)

THIS DRAWING IS PROPERTY OF HUBBELL INC. WIEGMANN
ALL INFORMATION IS PROPRIETARY AND NOT TO BE DUPLICATED