

TOP VIEW

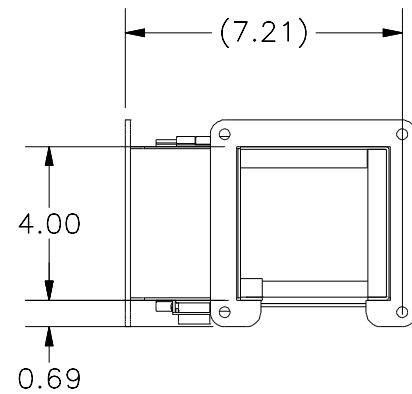

RIGHT SIDE VIEW

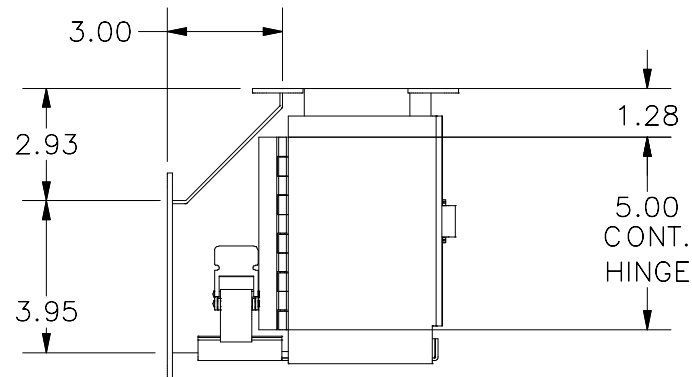

BOTTOM VIEW

QUICK-RELEASE
DRAW LATCH
(2 PL.)

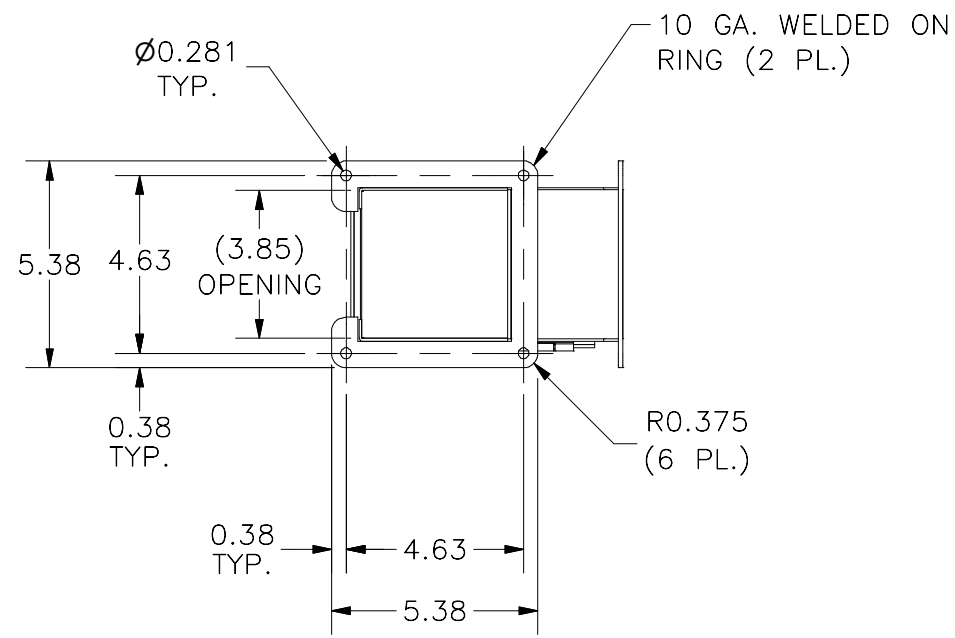
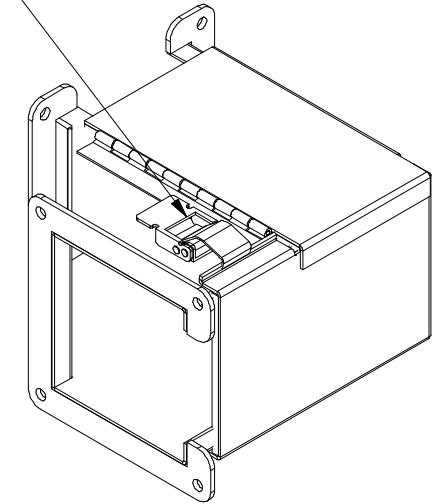

FRONT VIEW

PART#: LJW904CCW
(DATA SUBJECT TO CHANGE WITHOUT NOTICE)

THIS DRAWING IS PROPERTY OF HUBBELL INC. WIEGMANN
ALL INFORMATION IS PROPRIETARY AND NOT TO BE DUPLICATED