

TOP VIEW

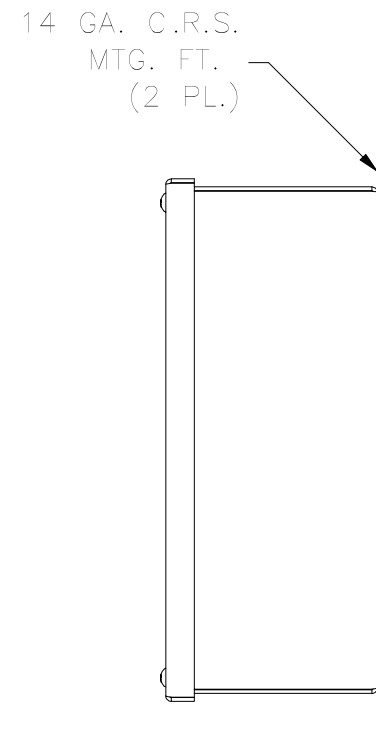

RIGHT SIDE VIEW

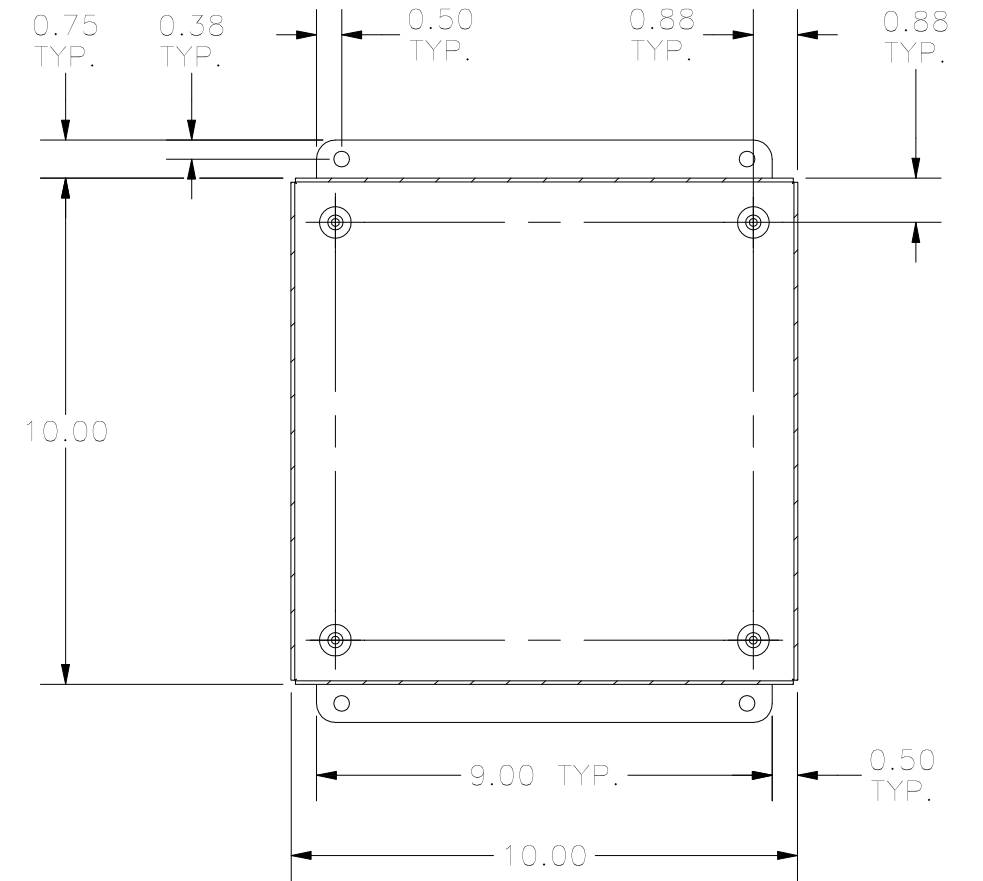

**SECTION K-K
(INSIDE BACK OF ENCLOSURE)**

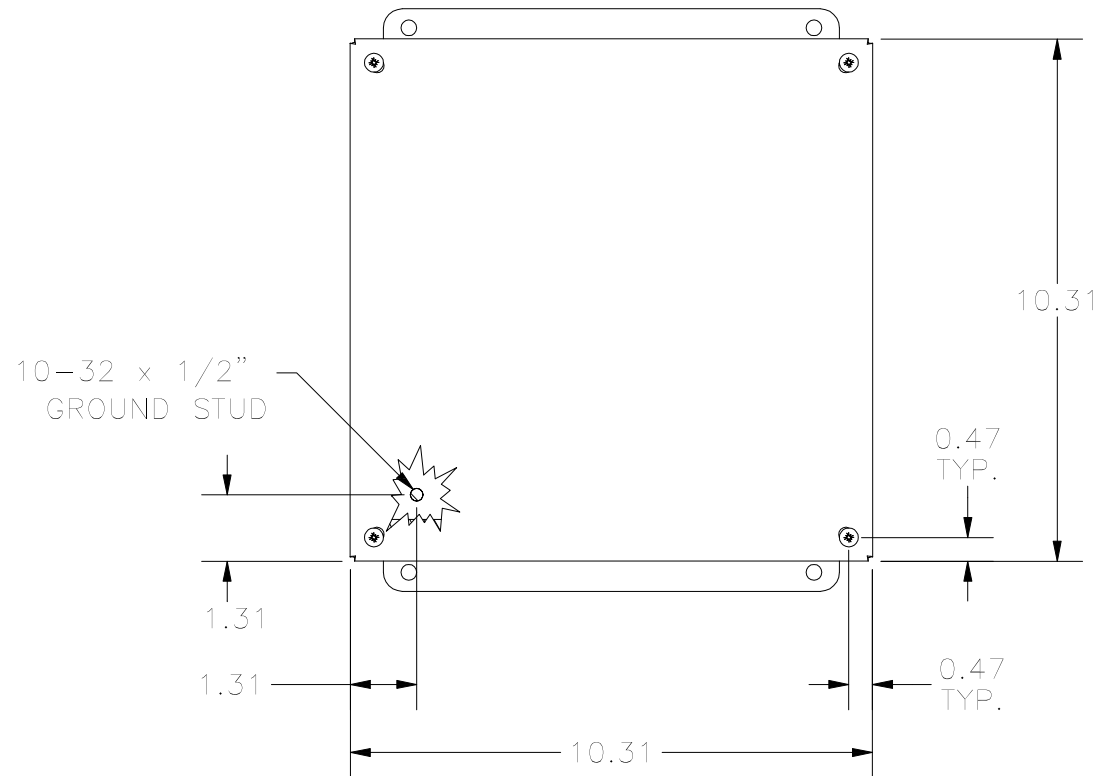

FRONT VIEW

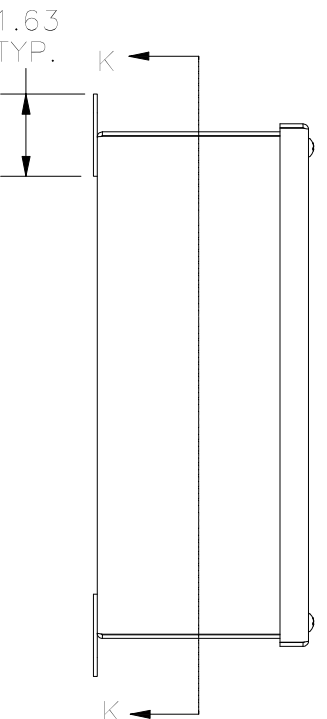

LEFT SIDE VIEW

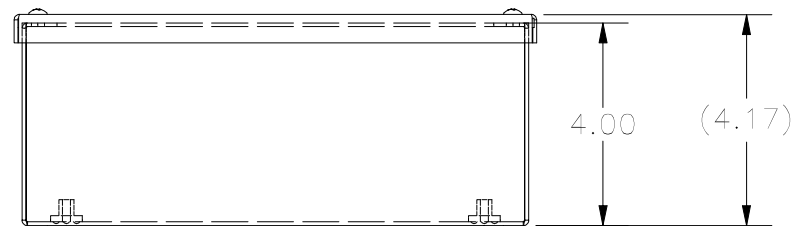

BOTTOM VIEW

PART#: B101004SC
(DATA SUBJECT TO CHANGE WITHOUT NOTICE)

THIS DRAWING IS PROPERTY OF HUBBELL INC. WIEGMANN
ALL INFORMATION IS PROPRIETARY AND NOT TO BE DUPLICATED