

# Installation, Maintenance, & Repair Series 007 and LF007

## Double Check Valve Assemblies

Sizes: 1/2" – 3" (15 - 80mm)

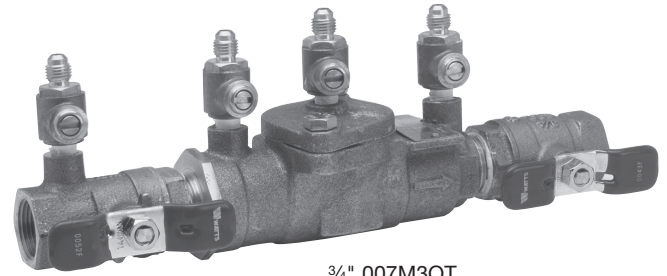

3/4" 007M3QT

**⚠ WARNING**



Read this Manual **BEFORE** using this equipment. Failure to read and follow all safety and use information can result in death, serious personal injury, property damage, or damage to the equipment. Keep this Manual for future reference.



**⚠ WARNING**

Local building or plumbing codes may require modifications to the information provided. You are required to consult the local building and plumbing codes prior to installation. If the information provided here is not consistent with local building or plumbing codes, the local codes should be followed. This product must be installed by a licensed contractor in accordance with local codes and ordinances.

**⚠ WARNING**

**Need for Periodic Inspection/Maintenance:** This product must be tested periodically in compliance with local codes, but at least once per year or more as service conditions warrant. All products must be retested once maintenance has been performed. Corrosive water conditions and/or unauthorized adjustments or repair could render the product ineffective for the service intended. Regular checking and cleaning of the product's internal and external components helps assure maximum life and proper product function.

**NOTICE**

For Australia and New Zealand, line strainers should be installed between the upstream shutoff valve and the inlet of the backflow preventer.

Watts product specifications in U.S. customary units and metric are approximate and are provided for reference only. For precise measurements, please contact Watts Technical Service. Watts reserves the right to change or modify product design, construction, specifications, or materials without prior notice and without incurring any obligation to make such changes and modifications on Watts products previously or subsequently sold.

### Testing

For field testing procedure, refer to Watts installation sheets IS-TK-DP/DL, IS-TK-9A, IS-TK-99E and IS-TK-99D found on **Watts.com**.

For other repair kits and service parts, refer to our Backflow Prevention Products Repair Kits & Service Parts price list PL-RP-BPD found on **Watts.com**.

For technical assistance, contact your local Watts representative.

## Installation Instructions Series 007 and LF007

1/2" - 2" (15 - 50mm)

### Indoors - Figure 1

Check local codes for installation requirements. Pipe lines should be thoroughly flushed to remove foreign material before installing the unit. A strainer should be installed as shown, ahead of backflow preventer to prevent disc from unnecessary fouling. Install valve inline with arrow on valve body pointing in the direction of flow.

For indoor installations, it is important that the valve be easily accessible to facilitate testing and servicing. Do not install in a concealed location.

**⚠ CAUTION**

Do not install with strainer when backflow preventer is used on seldom-used water lines which are called upon during emergencies, such as fire sprinkler lines, etc.

It is important that Series 007 and LF007 be tested periodically in compliance with local codes, but at least once a year or more often depending upon system conditions. Regular inspection, testing and cleaning assures maximum life and proper product function.

**NOTICE**

Fire Protection System Installations

The National Fire Protection Agency (NFPA) Guidelines require a confirming flow test to be conducted whenever a "main line" valve such as the shutoff valves or a backflow assembly have been operated. Certified testers of backflow assemblies must conduct this test. The trim valves of the detector meter bypass line, on assemblies so equipped, should be shutoff during the confirming flow test. When the test is completed, the trim valves must be returned to a fully open position.

### Meter Box Installation

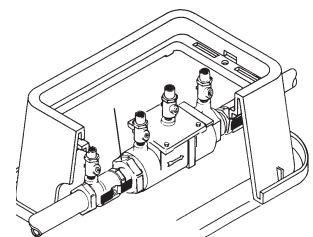

# Installation Instructions

## Series 007 and LF007

1/2" - 2" (15 - 50mm)

Figure 1

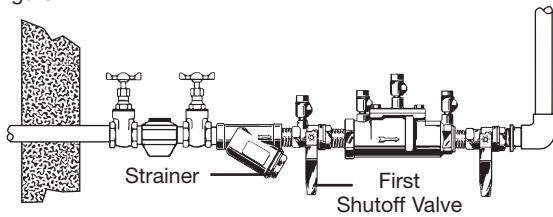

007QT-S / LF007QT-S

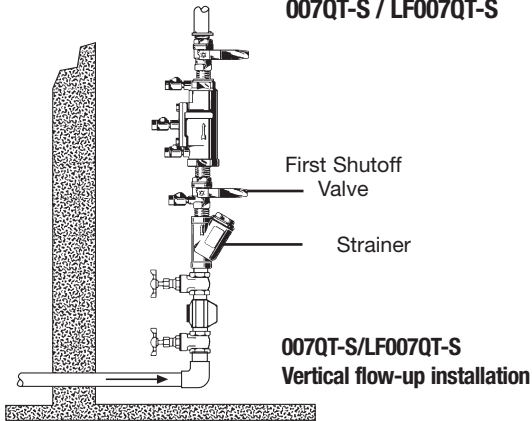

Figure 2

WattsBox Insulated Enclosure  
Available in Aluminum or Fiberglass.  
For more information, send for ES-WB.

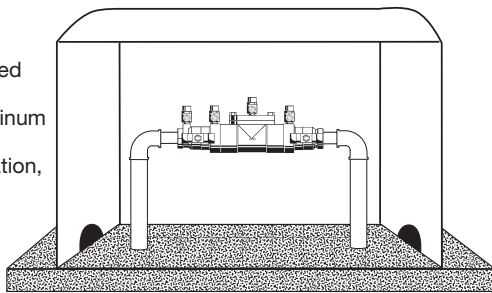
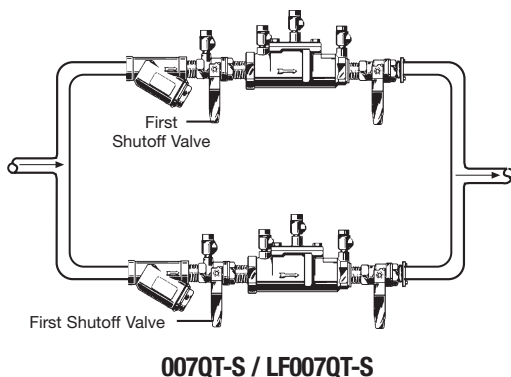

Figure 3



For repair kits and parts, refer to our Backflow Prevention Products Repair Kits & Service Parts price list PL-RP-BPD found on [www.watts.com](http://www.watts.com).

## Parallel - Figure 3

Two or more Series 007 and LF007 smaller size valves may be piped in parallel (where approved) to serve a larger supply pipe main. This type of installation is employed whenever it is vital to maintain a continuous supply of water/where interruptions for testing and servicing would be unacceptable. It also has the advantage of providing increased capacity where needed beyond that provided by a single valve and permits testing or servicing of an individual valve without shutting down the complete line.

For two valve installations the total capacity of the devices should equal or exceed that required by the system.

The quantity of valves used in parallel should be determined by the engineers judgement based on the operating conditions of a specific installation.

## Service and Maintenance

### Servicing the First and Second Check Valves

#### NOTICE

Before servicing, ensure supply water is turned off or shutoff valves are in the closed position.

1. Remove the cover, then remove the retainer from the body valve. The check valve modules can now be removed from the valve by hand or with a screwdriver.

#### NOTICE

For Series 007 and LF007 sizes 1/2" - 2" (15-50mm), the seats and springs of the first and second check modules are not interchangeable. The heavier spring and smaller diameter seat belong with the first check module. Series 007M1 sizes 3/4" - 1" (20-25mm) and Series 007M2 3/4" (20mm) have interchangeable seats and springs.

2. The check seats are attached to the cage with a bayonet type locking arrangement. Holding the cage in one hand, push the seat inward and rotate clockwise against the cage. For 3/4" (20mm) Series 007M2/LF007M2 and LF007 pull apart seat and cage. The seat, cage, spring and disc assembly are now individual components.
3. The disc assembly may now be cleaned and reassembled or, depending on its condition, it may be discarded and replaced with a new assembly from the repair kit. O-rings should be cleaned or replaced as necessary.
4. Reassemble the check valve module in the reverse order. Check modules are installed in the valve body with the seats facing the valve inlet. The modules must be secured in place before the retainer can be replaced. On the 3/4" - 1" (20-25mm) size, this retainer may have to be tilted slightly into place. Replace cover.

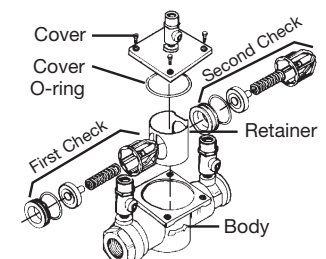
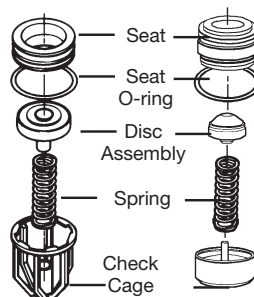
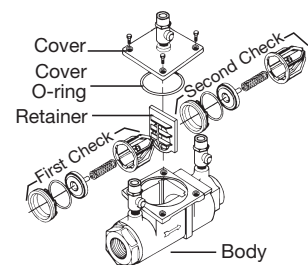
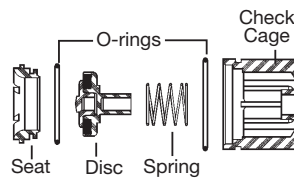

# Installation Instructions

## Series 007 and LF007

2½" and 3"

### Indoors - Figure 4

Series 007 may be installed in either a vertical or horizontal position. Pipe lines should be thoroughly flushed to remove foreign material before installing the unit. A strainer should be installed as shown, ahead of backflow preventer to prevent disc from unnecessary fouling. Install valve inline with arrow on valve body pointing in the direction of flow.

For indoor installations, it is important that the valve be easily accessible to facilitate testing and servicing. Do not install in a concealed location.

#### **CAUTION**

Do not install with strainer when backflow preventer is used on seldom-used water lines which are called upon during emergencies, such as fire sprinkler lines, etc.

It is important that Series 007 and LF007 be tested periodically in compliance with local codes, but at least once a year or more often depending upon system conditions.

#### **NOTICE**

Fire Protection System Installations

The National Fire Protection Agency (NFPA) Guidelines require a confirming flow test to be conducted whenever a "main line" valve such as the shutoff valves or a backflow assembly have been operated. Certified testers of backflow assemblies must conduct this test. The trim valves of the detector meter bypass line, on assemblies so equipped, should be shutoff during the confirming flow test. When the test is completed, the trim valves must be returned to a fully open position.

### Outside Building Above Ground -

#### Figure 5

In an area where freezing conditions do not occur, Series 007 and LF007 can be installed outside of a building. The most satisfactory installation is above ground and should be installed in this manner whenever possible. In an area where freezing conditions can occur, Series 007 and LF007 should be installed above ground in an insulated enclosure.

Annual inspection of all water system safety and control valves is required and necessary. Regular inspection, testing and cleaning assures maximum life and proper product function.

### Parallel - Figure 6

#### Consult Local codes for Approval

Two or more Series 007 and LF007 smaller size valves may be piped in parallel (where approved) to serve a larger supply pipe main. This type of installation is employed whenever it is vital to maintain a continuous supply of water/where interruptions for testing and servicing would be unacceptable. It also has the advantage of providing increase capacity where needed beyond that provided by a single valve and permits testing or servicing of an individual valve without shutting down the complete line. For two valve installations the total capacity should equal or exceed that required by the system.

The quantity of valves used in parallel should be determined by the engineer's judgement based on the operating conditions of a specific installation. (See F-FC regarding flow curves)

#### **NOTICE**

The flange gasket bolts for the gate valves should be retightened during installation as the bolts may have loosened due to storage and shipping.

Figure 4

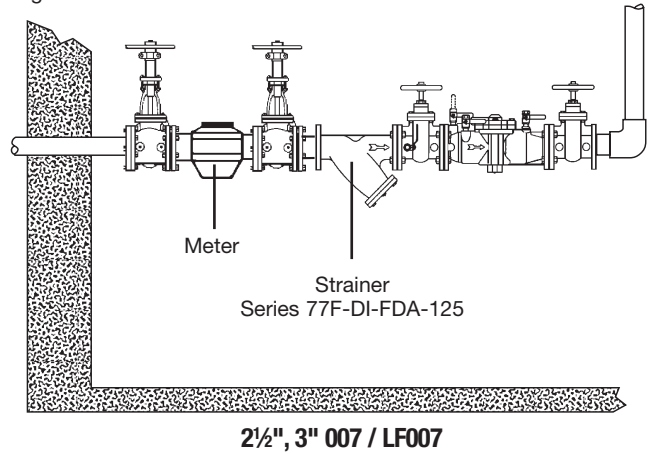

Figure 5

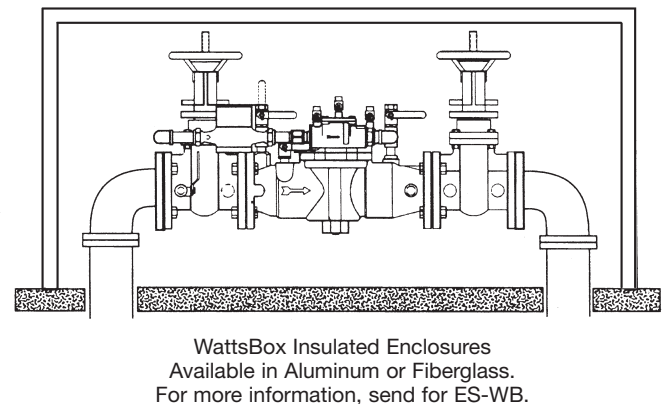
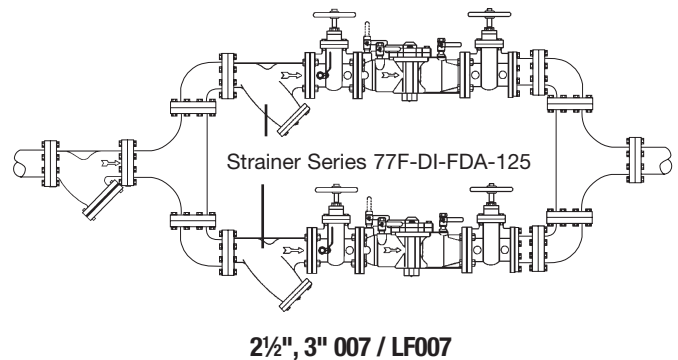

Figure 6



# Servicing First and Second Check Valves

## Series 007 and LF007

### 2½" and 3"

1. Remove cover bolts and cover.
2. Remove the retainer from the body bore. The check valve modules can now be removed from the valve by hand or with a screwdriver.
3. The check seats are attached to the cage with a bayonet type locking arrangement. Holding the cage in one hand, push the seat inward and rotate counterclockwise against the cage. The seat, spring cage, spring and disc assembly are now individual components.
4. The disc assembly may now be cleaned and reassembled or depending on its condition, may be discarded and replaced with a new assembly from the repair kit. O-rings should be cleaned or replaced as necessary. For more information, refer to repair parts price list PL-RP-BPD.
5. Reassemble the Check valve modules. Check modules are installed in the valve body with the seats facing the valve inlet. The modules must be securely in place before the retainer can be replaced.

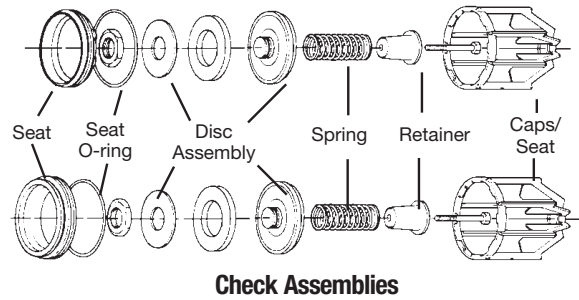

Check Assemblies

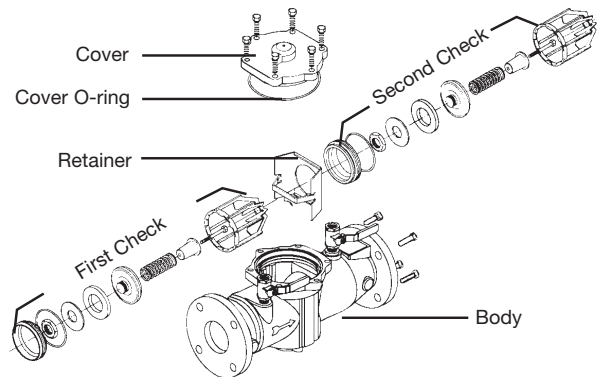

No special tools required to service Series 007 and LF007.

## Troubleshooting Guide — Series 007 and LF007

Symptom	Cause	Solution
1. Check valve fails to hold 1.0 PSID minimum	a. Debris on check disc sealing surface b. Leaking gate valve c. Damaged seat disc or seat o-ring d. Damaged guide holding check open e. Weak or broken spring	Disassemble and clean Disassemble and clean or repair Disassemble and replace Disassemble and clean or replace Disassemble and replace spring
2. Chatter during flow conditions	a. Worn, damaged or defective guide	Disassemble and repair or replace guide
3. Low flows passing through mainline valve	a. Mainline check fouled b. Meter strainer plugged c. Damaged mainline seat disc or seat d. Broken mainline spring	Disassemble and clean Disassemble and clean Disassemble and replace Disassemble and replace

For repair kits and parts, refer to our Backflow Prevention Products Repair Kits & Service Parts price list PL-RP-BPD found on [www.watts.com](http://www.watts.com).

**WARNING:** This product contains chemicals known to the State of California to cause cancer and birth defects or other reproductive harm.  
**For more information:** [www.watts.com/prop65](http://www.watts.com/prop65)

**Limited Warranty:** Watts Regulator Co. (the "Company") warrants each product to be free from defects in material and workmanship under normal usage for a period of one year from the date of original shipment. In the event of such defects within the warranty period, the Company will, at its option, replace or recondition the product without charge.

**THE WARRANTY SET FORTH HEREIN IS GIVEN EXPRESSLY AND IS THE ONLY WARRANTY GIVEN BY THE COMPANY WITH RESPECT TO THE PRODUCT. THE COMPANY MAKES NO OTHER WARRANTIES, EXPRESS OR IMPLIED. THE COMPANY HEREBY SPECIFICALLY DISCLAIMS ALL OTHER WARRANTIES, EXPRESS OR IMPLIED, INCLUDING BUT NOT LIMITED TO THE IMPLIED WARRANTIES OF MERCHANTABILITY AND FITNESS FOR A PARTICULAR PURPOSE.**

The remedy described in the first paragraph of this warranty shall constitute the sole and exclusive remedy for breach of warranty, and the Company shall not be responsible for any incidental, special or consequential damages, including without limitation, lost profits or the cost of repairing or replacing other property which is damaged if this product does not work properly, other costs resulting from labor charges, delays, vandalism, negligence, fouling caused by foreign material, damage from adverse water conditions, chemical, or any other circumstances over which the Company has no control. This warranty shall be invalidated by any abuse, misuse, misapplication, improper installation or improper maintenance or alteration of the product.

Some States do not allow limitations on how long an implied warranty lasts, and some States do not allow the exclusion or limitation of incidental or consequential damages. Therefore the above limitations may not apply to you. This Limited Warranty gives you specific legal rights, and you may have other rights that vary from State to State. You should consult applicable state laws to determine your rights. **SO FAR AS IS CONSISTENT WITH APPLICABLE STATE LAW, ANY IMPLIED WARRANTIES THAT MAY NOT BE DISCLAIMED, INCLUDING THE IMPLIED WARRANTIES OF MERCHANTABILITY AND FITNESS FOR A PARTICULAR PURPOSE, ARE LIMITED IN DURATION TO ONE YEAR FROM THE DATE OF ORIGINAL SHIPMENT.**



A Watts Water Technologies Company

USA: Tel: (978) 689-6066 • Fax: (978) 975-8350 • [Watts.com](http://Watts.com)

Canada: Tel: (905) 332-4090 • Fax: (905) 332-7068 • [Watts.ca](http://Watts.ca)

Latin America: Tel: (52) 81-1001-8600 • Fax: (52) 81-8000-7091 • [Watts.com](http://Watts.com)