CATALOG

Homac®

Underground distribution



Thomas & Betts is now ABB Installation Products, but our long legacy of quality products and innovation remains the same. From connectors that help wire buildings on Earth to cable ties that help put machines in space, we continue to work every day to make, market, design and sell products that provide a smarter, safer and more reliable flow of electricity, from source to socket.

Table of contents

004–020	Stud-mount transformer connectors
021–032	Pad-mount transformer connectors
033	Network protector connectors
034	Drop-on insulating boots
035–052	Flood-Seal® multi-port connectors
053–059	Pedestal connectors and covers
060	Wildlife protectors
061–066	Compression splice kits
067–068	Aluminum mechanical splice kits
069–070	Insulating covers and end caps
071	Pipe and conduit seals
072–075	Breakaway street light kits
076–077	Mechanical street light connectors
078	Equipment locks
079–080	Sealants and lubricants
081–088	Index

Stud-mount transformer connectors

Aluminum universal quick-disconnect transformer connectors



EZB 6500 SL



EZC 6500 SL

The EZ mount connector is used on padmount distribution transformers that have a $\frac{5}{8}$ " or 1" secondary bushing stud – one mounting hole accepts both sizes of studs without repositioning the connector.

- Quick-disconnect connectors are easy to install or remove
- Dual-rated to accept aluminum or copper conductors
- Provides a wide cable range
- Clear slide-on PVC insulating cover on EZC series enables safe and time-saving installations and disconnects
- Meets or exceeds ANSI C119.4 specifications
- RUS Accepted

EZC series insulated in-line bar

Cat. no.	Cable range (AWG or kcmil)	Outlets	Length (in.)	Stud size (in.)
EZC 4350 SL	#12–350, S/L #14–#2	4	6 $\frac{3}{4}$	$\frac{5}{8}$ & 1
EZC 6350 SL		6	8 $\frac{3}{4}$	
EZC 8350 SL		8	10 $\frac{3}{4}$	
EZC 4500 SL	#6–500, S/L #14–#2	4	6 $\frac{3}{4}$	
EZC 6500 SL		6	8 $\frac{3}{4}$	
EZC 8500 SL		8	10 $\frac{3}{4}$	
EZC 8750 SL*	1/0–750, S/L #14–#2	8	12 $\frac{7}{8}$	

* Two set-screws per outlet.

Note: For oxide-inhibitor option, add "-C" suffix to the catalog number.

For additional sizes, please consult your ABB representative.

For a single-phase kit containing one uninsulated and two insulated connectors, add "-1K" suffix to the catalog number.

For a three-phase kit containing one uninsulated and three insulated connectors, add "-3K" suffix to the catalog number.

EZB series uninsulated in-line bar

Cat. no.	Cable range (AWG or kcmil)	Outlets	Length (in.)	Stud size (in.)
EZB 4350 SL	#12–350, S/L #14–#2	4	6 $\frac{3}{4}$	$\frac{5}{8}$ & 1
EZB 6350 SL		6	8 $\frac{3}{4}$	
EZB 8350 SL		8	10 $\frac{3}{4}$	
EZB 4500 SL	#6–500, S/L #14–#2	4	6 $\frac{3}{4}$	
EZB 6500 SL		6	8 $\frac{3}{4}$	
EZB 8500 SL		8	10 $\frac{3}{4}$	
EZB 8750 SL*	1/0–750, S/L #14–#2	8	12 $\frac{7}{8}$	

* Two set-screws per outlet.

Note: For oxide-inhibitor option, add "-C" suffix to the catalog number.

For additional sizes, please consult your ABB representative.

01 For EZ Torque® shear-head screws supplied in all outlets, add "-TS" suffix to the catalog number. Shear-head screw is available for both the stud locking screws as well as all 350 cable port screws.



01

Stud-mount transformer connectors

Aluminum transformer connectors – CSW and CSS series



CSS 6500



CSW 4350

Choose from quick-disconnect or screw-on transformer connectors with clear PVC insulating covers.

- Clear PVC insulating boot enables safe and time-saving installations and disconnects, and it features self-sealing wrench outlets and self-adjusting cable outlets
- Disconnectable — easy to install or remove
- Dual-rated to accept aluminum or copper conductors
- Provides a wide cable range
- Meets or exceeds ANSI C119.4 specifications
- RUS Accepted

Aluminum transformer connectors

Quick disconnect cat. no.	Screw-on style cat. no.	Stud size (in.)	Outlets	Insulator length (in.)	Cable range (AWG or kcmil)
CSW 4350	CSS 4350	5/8	4	5 11/16	#12–350
CSW 6350	CSS 6350	5/8	6	7 1/16	
CSW 8350	CSS 8350	5/8	8	9 1/16	
CSW 4350-1	CSS 4350-1	1	4	11 1/16	
CSW 6350-1	CSS 6350-1	1	6	5 1/16	
CSW 8350-1	CSS 8350-1	1	8	7 1/16	
CSW 4500-58	CSS 4500-58	5/8	4	9 1/16	#2–500
CSW 6500-58	CSS 6500-58	5/8	6	11 1/16	
CSW 8500-58	CSS 8500-58	5/8	8	5 3/16	
CSW 4500	CSS 4500	1	4	7 3/16	
CSW 6500	CSS 6500	1	6	9 3/16	
CSW 8500	CSS 8500	1	8	11 3/16	

Diagrams

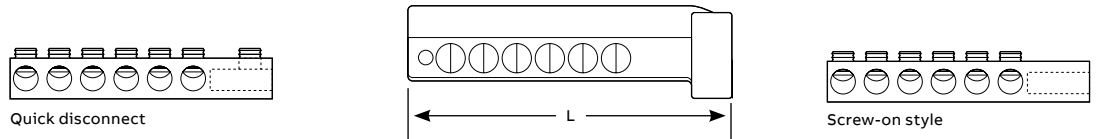

Note: For oxide-inhibitor option, add “-C” suffix to the catalog number.
For streetlight-outlet option, add “-SL” suffix to the catalog number.

01 For EZ Torque® shear-head screws supplied in all outlets, add “-TS” suffix to the catalog number. Shear-head screw is available for both the stud locking screws as well as all 350 cable port screws.



01

Stud-mount transformer connectors

Aluminum quick-disconnect transformer connectors – ABW in-line bar series



ABW 8500

High-strength aluminum alloy maintains constant bolting pressure on conductors.

- Quick disconnectability for easy removal from transformer secondary studs
- Dual-rated to accept aluminum or copper conductors
- Provides a wide cable range
- Ball-bottom screws ensure maximum conductor contact pressure and break up interstrand oxides
- Meets or exceeds ANSI C119.4 specifications
- RUS Accepted

ABW series – In-line bar

Cat. no.	Outlets	Length (in.)	Boot no.	Cable range (AWG or kcmil)	Stud size (in.)
ABW 240	2	3 $\frac{3}{8}$	SB 17	#6–250	$\frac{5}{8}$
ABW 340	3	3 $\frac{3}{8}$	SB 17		
ABW 440	4	4 $\frac{1}{16}$	SB 17		
ABW 540	5	5 $\frac{1}{2}$	SB 11		
ABW 640	6	6 $\frac{1}{4}$	SB 11		
ABW 740	7	7	SB 11		
ABW 840	8	7 $\frac{13}{16}$	SB 14		
ABW 2350	2	3 $\frac{1}{2}$	SB 17	#12–350	$\frac{5}{8}$
ABW 3350	3	4 $\frac{1}{2}$	SB 17		$\frac{5}{8}$
ABW 4350	4	5 $\frac{1}{2}$	SB 17		$\frac{5}{8}$
ABW 4350-1	4	6 $\frac{9}{16}$	SB 17		1
ABW 5350	5	6 $\frac{1}{2}$	SB 11		$\frac{5}{8}$
ABW 6350	6	7 $\frac{1}{2}$	SB 11		$\frac{5}{8}$
ABW 6350-1	6	8 $\frac{9}{16}$	SB 11		1
ABW 7350	7	8 $\frac{1}{2}$	SB 14		$\frac{5}{8}$
ABW 8350	8	9 $\frac{1}{2}$	SB 2160		$\frac{5}{8}$
ABW 8350-1	8	10 $\frac{9}{16}$	SB 2160		1

Cat. no.	Outlets	Length (in.)	Boot no.	Cable range (AWG or kcmil)	Stud size (in.)
ABW 2500	2	4 $\frac{1}{16}$	SB 2147	#6–500	1
ABW 3500	3	5 $\frac{1}{16}$	SB 2147		
ABW 4500	4	6 $\frac{1}{16}$	SB 2163-38		
ABW 5500	5	7 $\frac{1}{16}$	SB 2163-7		
ABW 6500	6	8 $\frac{1}{16}$	SB 2157		
ABW 7500	7	9 $\frac{1}{16}$	SB 2157		
ABW 8500	8	10 $\frac{1}{16}$	SB 2160		
ABW 2750	2	5 $\frac{1}{16}$	SB 2147	1/0–750	1
ABW 3750	3	6 $\frac{7}{16}$	SB 2163-38		
ABW 4750	4	7 $\frac{3}{4}$	SB 2120		
ABW 5750	5	9 $\frac{1}{8}$	SB 2157		
ABW 6750	6	10 $\frac{1}{2}$	SB 2160		
ABW 7750	7	11 $\frac{13}{16}$	SB 2160		
ABW 8750	8	13 $\frac{1}{8}$	SB 2163-10		

Diagram

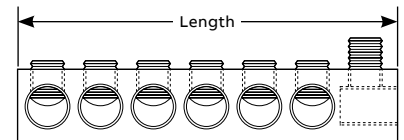

Note: For oxide-inhibitor option, add “-C” suffix to the catalog number.

For streetlight-outlet option, add “-SL” suffix to the catalog number.

For insulating boots, see page 34.

For special applications and stud sizes, please consult your ABB representative.

01 For EZ Torque® shear-head screws supplied in all outlets, add “-TS” suffix to the catalog number. Shear-head screw is available for both the stud locking screws as well as all 350 cable port screws.



01

Stud-mount transformer connectors

Aluminum quick-disconnect transformer connectors – ABW double-row bar series



ABW 350-33

- Dual-rated for aluminum or copper conductors.
- High-strength aluminum alloy maintains constant bolting pressure on conductors
 - Quick disconnectability for easy removal from transformer secondary studs
 - Ball-bottom screws ensure maximum conductor contact pressure and break up interstrand oxides
 - Meets or exceeds ANSI C119.4 specifications
 - RUS Accepted

ABW series – Double-row bar

Cat. no.	Outlets	Length (in.)	Width (in.)	Boot no.	Cable range (AWG or kcmil)	Stud size (in.)
ABW 40-22	4	3½	2½	SB 16	#6-250	5/8
ABW 40-33	6	4¼		SB 16		
ABW 40-44	8	5¼		SB 16		
ABW 350-22	4	4	2¾	SB 16	#12-350	1
ABW 350-33	6	4⅞		SB 16		
ABW 350-44	8	5⅞		SB 2163-38		
ABW 500-22	4	4⅞	2¾	SB 2151	#6-500	1
ABW 500-33	6	5⅞		SB 2158		
ABW 500-44	8	6⅞		SB 2158		
ABW 750-22	4	4¾	2¾	SB 2158	1/0-750	1
ABW 750-33	6	6⅞		SB 2158		
ABW 750-44	8	7⅞		SB 2163-7		

Diagram

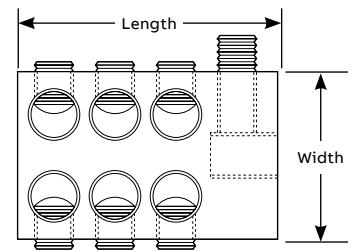

Note: For oxide-inhibitor option, add "-C" suffix to the catalog number.
 For streetlight-outlet option, add "-SL" suffix to the catalog number.
 For insulating boots, see page 34.
 For special applications and stud sizes, please consult your ABB representative.

01 For EZ Torque® shear-head screws supplied in all outlets, add "-TS" suffix to the catalog number. Shear-head screw is available for both the stud locking screws as well as all 350 cable port screws.



01

Stud-mount transformer connectors

Aluminum screw-on transformer connectors – ABS in-line bar series



Disconnectability makes it easy to remove from transformer secondary threaded studs.

- High-strength aluminum alloy maintains constant bolting pressure on conductors
- Dual-rated to accept aluminum or copper conductors
- Ball-bottom screws ensure maximum conductor contact pressure and break up interstrand oxides
- Meets or exceeds ANSI C119.4 specifications
- RUS Accepted

ABS series – Single-line bar

Cat. no.	Boot no.	Stud size (in.)	Outlets	Length (in.)	Cable range (AWG or kcmil)
ABS 240	Contact ABB Rep	5/8	2	2 7/8	#6–250
ABS 340	Contact ABB Rep	5/8	3	3 5/8	
ABS 440	SB 17	5/8	4	4 7/16	
ABS 540	SB 17	5/8	5	5 1/4	
ABS 640	SB 11	5/8	6	6	
ABS 740	SB 11	5/8	7	6 13/16	
ABS 840	SB 14	5/8	8	7 9/16	
ABS 2350	Contact ABB Rep	5/8	2	3 1/4	#12–350
ABS 3350	SB 17	5/8	3	4 1/4	
ABS 4350	SB 17	5/8	4	5 1/4	
ABS 4350-1	SB 17	1	4	5 1/4	
ABS 5350	SB 17	5/8	5	6 1/4	
ABS 6350	SB 11	5/8	6	7 1/4	
ABS 6350-1	SB 11	1	6	7 1/4	
ABS 7350	SB 11	5/8	7	8 1/4	
ABS 8350	SB 14	5/8	8	9 1/4	
ABS 8350-1	SB 14	1	8	9 1/4	

Cat. no.	Boot no.	Stud size (in.)	Outlets	Length (in.)	Cable range (AWG or kcmil)
ABS 2500	SB 17	1	2	3 13/16	#6–500
ABS 3500	SB 17	1	3	4 13/16	
ABS 4500	SB 17	1	4	5 13/16	
ABS 5500	SB 2120	1	5	6 13/16	
ABS 6500	SB 2157	1	6	7 13/16	
ABS 7500	SB 2157	1	7	8 13/16	
ABS 8500	SB 2160	1	8	9 13/16	
ABS 2750	SB 17	1	2	4 1 1/16	1/0–750
ABS 3750	SB 17	1	3	6	
ABS 4750	SB 2120	1	4	7 3/8	
ABS 5750	SB 2157	1	5	8 1 1/16	
ABS 6750	SB 2160	1	6	10 1/16	
ABS 7750	SB 2160	1	7	11 3/8	
ABS 8750	SB 2163-10	1	8	12 3/4	

Diagram

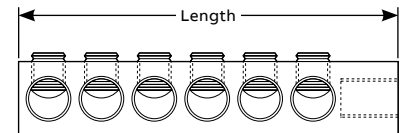

Note: For oxide-inhibitor option, add “-C” suffix to the catalog number.
 For streetlight-outlet option, add “-SL” suffix to the catalog number.
 For insulating boots, see page 34.
 For special applications and stud sizes, please consult your ABB representative.

01 For EZ Torque® shear-head screws supplied in all outlets, add “-TS” suffix to the catalog number. Shear-head screw is available for all 350 cable port screws.



01

Stud-mount transformer connectors

Aluminum screw-on transformer connectors – ABS double-row bar series

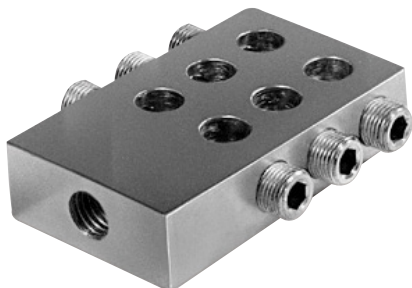

- Ball-bottom screws ensure maximum conductor contact pressure and break up interstrand oxides.
- High-strength aluminum alloy maintains constant bolting pressure on conductors
 - Dual-rated to accept aluminum or copper conductors
 - Meets or exceeds ANSI C119.4 specifications
 - RUS Accepted

ABS series – Double-line bar

Cat. no.	Boot no.	Stud size (in.)	Outlets	Length (in.)	Cable range (AWG or kcmil)
ABS 40-22	SB 16	$\frac{5}{8}$	4	$3\frac{1}{16}$	#6–250
ABS 40-33	SB 16		6	$3\frac{7}{8}$	
ABS 40-44	SB 16		8	$4\frac{11}{16}$	
ABS 350-22	SB 16		4	$3\frac{5}{8}$	#12–350
ABS 350-33	SB 16		6	$4\frac{1}{2}$	
ABS 350-44	SB 16		8	$5\frac{7}{16}$	
ABS 500-22	SB 2151	1	4	$3\frac{15}{16}$	#6–500
ABS 500-33	SB 2151		6	$4\frac{15}{16}$	
ABS 500-44	SB 2163-6		8	$5\frac{15}{16}$	
ABS 750-22	SB 2151		4	$4\frac{1}{4}$	1/0–750
ABS 750-33	SB 2163-6		6	$5\frac{9}{16}$	
ABS 750-44	SB 2163-6		8	$6\frac{15}{16}$	

Diagram

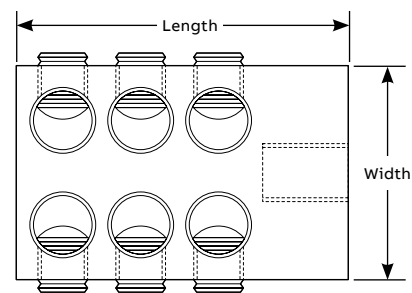

Notes: For oxide-inhibitor option, add “-C” suffix to the catalog number.
 For streetlight-outlet option, add “-SL” suffix to the catalog number.
 For insulating boots, see page 34.
 For special applications and stud sizes, please consult your ABB representative.

01 For EZ Torque® shear-head screws supplied in all outlets, add “-TS” suffix to the catalog number.



01

Stud-mount transformer connectors

Aluminum universal quick-disconnect transformer connectors – RAU series



RAU 6500

RAU series connectors

Dual-rated solutions.

- Space-saving compact size also reduces cantilever stress on bushings
- Universal connector fits both 5/8" and 1" studs.
- RUS Accepted

Diagrams	Cat. no.	Outlets	Insulator length (in.)	Cable range (AWG or kcmil)
	RAU 4500	4	5½	#6–500
	RAU 6500	6	6⅞	
	RAU 8500	8	8⅞	

Note: For oxide-inhibitor option, add "-C" suffix to the catalog number. For streetlight-outlet option, add "-SL" suffix to the catalog number. For see-through insulator option, add "w/cover" suffix to the catalog number.

Aluminum quick-disconnect transformer connectors – LRTR series



LRTR 8

LRTR series connectors

Get left-hand or right-hand installation capability.

- Disconnectable – easy to install or remove and fully insulated with EPDM rubber
- Dual-rated to accept aluminum or copper conductors

Diagrams	Cat. no.	Outlets	L (in.)	Wire size (AWG or kcmil)	Stud size (in.)
	LRTR 4	4	7	#12–350	5/8
	LRTR 6	6	9		
	LRTR 8	8	11		
	LRTR 4W*	4	7		
	LRTR 6W*	6	9		
	LRTR 8W*	8	11		

* Watertight cable and screw ports. Note: For oxide-inhibitor option, add "-C" suffix to the catalog number.

01 For EZ Torque® shear-head screws supplied in all outlets, add "-TS" suffix to the catalog number. Shear-head screw is available for both the stud locking screws as well as all 350 cable port screws.



01

Stud-mount transformer connectors

Aluminum quick-disconnect transformer connectors – CLRTR series

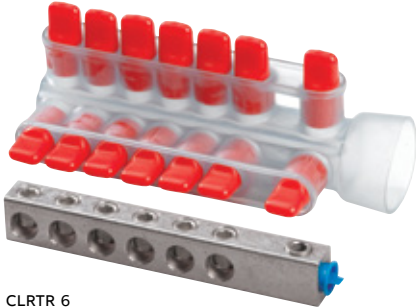

CLRTR 6

CLRTR series connectors

Cat. no.	Outlets	Stud size (in.)	Conductor range (AWG or kcmil)
CLRTR 4	4	5/8	#12–350
CLRTR 6	6		
CLRTR 45-58	4	1	#6–500
CLRTR 65-58	6		

Note: For oxide-inhibitor option, add “-C” suffix to the catalog number. For streetlight-outlet option, add “-SL” suffix to the catalog number.

01 For EZ Torque® shear-head screws supplied in all outlets, add “-TS” suffix to the catalog number. Shear-head screw is available for both the stud locking screws as well as all 350 cable port screws.



01

Aluminum quick-disconnect transformer connectors – ABD series



ABD 8350 SL

ABD series connectors

Cat. no.	Outlets	Stud size (in.)	Conductor range (AWG or kcmil)
ABD 4350 SL	4	5/8	#12–350
ABD 6350 SL	6		
ABD 8350 SL	8		
ABD 4350-1 SL	4	1	#12–350
ABD 6350-1 SL	6		
ABD 8350-1 SL	8		

Double-row configuration. Note: For oxide-inhibitor option, add “-C” suffix to the catalog number.

02 For EZ Torque® shear-head screws supplied in all outlets, add “-TS” suffix to the catalog number.



02

See more of what you're doing.

- Clear PVC enables safe and time-saving installations and disconnects – and provides insulation
- Versatile design enables right- or left-hand installation
- Dual-rated to accept aluminum or copper conductors
- RUS Accepted

Dual-rated and street light ready.

- #14 to #4 AWG street light outlet provides added versatility to make an additional connection
- Meets or exceeds ANSI C119.4 specifications
- RUS Accepted

Stud-mount transformer connectors

AD series adapter



AD 58

The adapter made for the ABD series.

- 5/8" or 1" stud sizes
- Compatible with ABD series (see previous page)

AD series adapter

Cat. no.	Stud size (in.)
AD 58	5/8
AD 1	1

Aluminum quick-disconnect transformer connectors – LRT series



LRT 6350

Clearly the best deadfront connector.

- Clear, see-through PVC insulator enables safe and time-saving installations and disconnects
- Insulates two, four, six or eight outlet connectors
- Versatile design enables right- or left-hand installation
- Integral wrench outlet covers mean no lost parts
- Dual-rated to accept aluminum or copper conductors
- Meets or exceeds ANSI C119.4 specifications
- RUS Accepted

Aluminum quick-disconnect transformer connectors

Cat. no.	Outlets	Insulator length (in.)	Wire range (AWG or kcmil)
LRT 2350	2	7 ¹ / ₄	#12–350
LRT 4350	4		
LRT 6350	6	10 ¹ / ₄	
LRT 8350	8		

Note: For oxide-inhibitor option, add “-C” suffix to the catalog number.

01 For EZ Torque® shear-head screws supplied in all outlets, add “-TS” suffix to the catalog number. Shear-head screw is available for both the stud locking screws as well as all 350 cable port screws.



01

Stud-mount transformer connectors

Aluminum universal quick-disconnect transformer connectors – ZVW-EZSL and Z-EZSL series



ZVW 4023 EZSL



Z 4023 EZSL

The EZ mount connector is used on padmount distribution transformers that have a $\frac{5}{8}$ " or 1" secondary bushing stud – one mounting hole accepts both sizes of studs without repositioning the connector.

- Tri-contact design distributes force more evenly than existing stud mounting configurations or other multi-stud designs, resulting in higher, more uniform contact force on the threads
- Design also eliminates the chance of movement
- Dual stud locking screws fully engage on either stud size, maximizing the engagement force on the stud
- Compact Zeebar® design halves cantilever stress and doubles cable capacity
- Easy to install, because $\frac{5}{8}$ " hex wrench does it all – including the street light outlet
- Truly universal – both series fit $\frac{5}{8}$ " or 1" studs
- Made from aluminum for high strength and high conductivity
- Quick-disconnect connectors are easy to install or remove
- #14 to #2 AWG street light outlet provides added versatility to make an additional connection
- Meets or exceeds ANSI C119.4 specifications
- RUS Accepted

ZVW-EZSL series with clear PVC lock-on insulating cover

Cat. no.	Outlets	Conductor range (AWG or kcmil)	Stud size (in.)
ZVW 4023 EZSL	6	#12–350	$\frac{5}{8}$ & 1
ZVW 5033 EZSL	8		
ZVW 4025 EZSL	6	#6–500	
ZVW 5035 EZSL	8		

Note: For oxide-inhibitor option, add "-C" suffix to the catalog number.

For a kit containing one uninsulated and two insulated connectors, add "-K" suffix to the catalog number.

Z-EZSL series with optional clear PVC drop-on insulating cover

Cat. no.	Outlets	Boot no.	Conductor range (AWG or kcmil)	Stud size (in.)
Z 4023 EZSL	6	EZ 5912-3	#12–350	$\frac{5}{8}$ & 1
Z 5033 EZSL	8	EZ 5912-7		
Z 4025 EZSL	6	EZ 5912-3	#6–500	
Z 5035 EZSL	8	EZ 5912-7		

Note: For oxide-inhibitor option, add "-C" suffix to the catalog number. A cover can also be installed on the Z-EZSL series. For details, please consult your ABB representative.

01 For EZ Torque® shear-head screws supplied in all outlets, add "-TS" suffix to the catalog number. Shear-head screw is available for both the stud locking screws as well as all 350 cable port screws.



01

Stud-mount transformer connectors

Aluminum universal quick-disconnect transformer connectors –
ZVW-USL, ZVW-SL and ZVW-1 SL series



ZVW 4045 USL



ZVW 3053-58 SL



ZVW 5033-1 SL

See-through, lock-on insulated boots make them the clear choice for secondary transformer connectors.

- Compact Zeebar® design halves cantilever stress and doubles cable capacity
- Easy to install with all screws on top
- A $\frac{5}{16}$ " hex wrench does it all – including the street light outlet
- ZVW-USL series fits both $\frac{5}{8}$ " or 1" studs; series are also available each for $\frac{5}{8}$ " and 1" studs
- Dual-rated to accept copper or aluminum conductors
- Ball-bottom screws ensure maximum conductor contact pressure and break up interstrand oxides
- Meets or exceeds ANSI C119.4 specifications
- RUS Accepted

ZVW-USL series

Cat. no.	Outlets	L (in.)	Conductor range (AWG or kcmil)	Stud size (in.)
ZVW 3033 USL	6	$5\frac{3}{8}$	#12–350	$\frac{5}{8}$ & 1
ZVW 4043 USL	8	$6\frac{3}{8}$		
ZVW 3035 USL	6	$5\frac{11}{16}$	#6–500	
ZVW 4045 USL	8	$6\frac{13}{16}$		
ZVW 3037 USL	6	$6\frac{3}{8}$	1/0–750	
ZVW 4047 USL	8	$7\frac{5}{8}$		

Note: For oxide-inhibitor option, add "-C" suffix to the catalog number. For a kit containing one uninsulated and two insulated connectors, add "-K" suffix to the catalog number.

ZVW-SL series

Cat. no.	Outlets	L (in.)	Conductor range (AWG or kcmil)	Stud size (in.)
ZVW 2044 SL	6	$3\frac{15}{16}$	#12–250	$\frac{5}{8}$
ZVW 3054 SL	8	$4\frac{3}{4}$		
ZVW 4064 SL	10	5		
ZVW 2043-58 SL	6	$4\frac{3}{8}$	#12–350	
ZVW 3053-58 SL	8	$5\frac{3}{8}$		

Note: For oxide-inhibitor option, add "-C" suffix to the catalog number. For a kit containing one uninsulated and two insulated connectors, add "-K" suffix to the catalog number.

ZVW-1 SL series

Cat. no.	Outlets	L (in.)	Conductor range (AWG or kcmil)	Stud size (in.)
ZVW 4023-1 SL	6	$4\frac{3}{4}$	#12–350	1
ZVW 5033-1 SL	8	$5\frac{3}{4}$		
ZVW 4025-1 SL	6	$5\frac{1}{8}$	#6–500	
ZVW 5035-1 SL	8	$6\frac{1}{4}$		

Note: For oxide-inhibitor option, add "-C" suffix to the catalog number. For a kit containing one uninsulated and two insulated connectors, add "-K" suffix to the catalog number.

01 For EZ Torque® shear-head screws supplied in all outlets, add "-TS" suffix to the catalog number. Shear-head screw is available for both the stud locking screws as well as all 350 cable port screws.



01

Stud-mount transformer connectors

Aluminum universal quick-disconnect transformer connectors –
Z-USL, Z-SL and Z-1 SL series



Z 4045 USL



Z 2043-58 SL



Z 5033-1 SL

Compact secondary transformer connectors with a street light outlet.

- Compact Zeebar® design halves cantilever stress and doubles cable capacity
- Easy to install with all screws on top
- A $\frac{5}{16}$ " hex wrench does it all – including the street light outlet
- Z-USL series fits both $\frac{5}{8}$ " or 1" studs; series are also available each for $\frac{5}{8}$ " and 1" studs
- Dual-rated to accept copper or aluminum conductors
- Ball-bottom screws ensure maximum conductor contact pressure and break up interstrand oxides
- Meets or exceeds ANSI C119.4 specifications
- RUS Accepted

Z-USL series

Cat. no.	Outlets	L (in.)	H (in.)	Conductor range (AWG or kcmil)	Stud size (in.)
Z 3033 USL	6	$5\frac{3}{8}$	$2\frac{7}{8}$	#12–350	$\frac{5}{8}$ & 1
Z 4043 USL	8	$6\frac{3}{8}$			
Z 3035 USL	6	$5\frac{11}{16}$		#6–500	
Z 4045 USL	8	$6\frac{13}{16}$			
Z 3037 USL	6	$6\frac{1}{16}$	$3\frac{1}{8}$	1/0–750	
Z 4047 USL	8	$7\frac{5}{16}$			

Note: For oxide-inhibitor option, add "-C" suffix to the catalog number. For insulating boot, please consult your ABB representative.

Z-SL series

Cat. no.	Outlets	L (in.)	H (in.)	Conductor range (AWG or kcmil)	Stud size (in.)
Z 2044 SL	6	$3\frac{15}{16}$	$1\frac{15}{16}$	#12–4/0	$\frac{5}{8}$
Z 3054 SL	8	$4\frac{3}{4}$			
Z 4064 SL	10	5			
Z 2043-58 SL	6	$4\frac{1}{4}$	$2\frac{3}{8}$	#12–350	
Z 3053-58 SL	8	$5\frac{1}{4}$			

Note: For oxide-inhibitor option, add "-C" suffix to the catalog number. For insulating boot, please consult your ABB representative.

Z-1 SL series

Cat. no.	Outlets	L (in.)	H (in.)	Conductor range (AWG or kcmil)	Stud size (in.)
Z 4023-1 SL	6	$4\frac{3}{4}$	$2\frac{7}{8}$	#12–350	1
Z 5033-1 SL	8	$5\frac{3}{4}$			
Z 4025-1 SL	6	$5\frac{1}{8}$		#6–500	
Z 5035-1 SL	8	$6\frac{1}{4}$			

Note: For oxide-inhibitor option, add "-C" suffix to the catalog number. For insulating boot, please consult your ABB representative.

01 For EZ Torque® shear-head screws supplied in all outlets, add "-TS" suffix to the catalog number. Shear-head screw is available for both the stud locking screws as well as all 350 cable port screws.



01

Stud-mount transformer connectors

Aluminum universal quick-disconnect transformer connectors – LRT-UW, LRT-UX and LRT-U series



LRT 44 UW



LRT 44 UX



LRT 33 U

Compact design halves cantilever stress and doubles cable capacity, lessening the occurrence of leaky bushings.

- LRT-UW Series features fully insulated transformer connector to protect connections
- LRT-UX Series features clear deadfront insulator for safe and time-saving installations and disconnects; locks in place by raised set screws or installation of the first conductor
- EPDM rubber cable adapters accommodate #12 solid to 250 kcmil conductors
- RUS Accepted

Aluminum universal quick-disconnect transformer connectors

Cat. no.	Cable range (AWG or kcmil)	Outlets	Stud size (in.)	L (in.)	H (in.)
LRT-UW series – Fully insulated with Flood-Seal® rockets					
LRT 33 UW	#12–350	6	5/8 & 1	3	2½
LRT 44 UW		8		4	
LRT-UX series – Fully insulated					
LRT 33 UX	#12–350	6	5/8 & 1	4	4¾
LRT 44 UX		8			
LRT-U series – Bare bar					
LRT 33 U	#12–350	6	5/8 & 1	3	2½
LRT 44 U		8		4	

Diagram

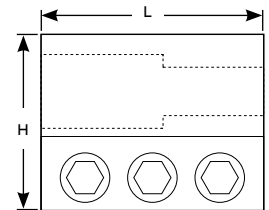

Note: For oxide-inhibitor option, add "-C" suffix to the catalog number. For a clear PVC insulating cover, see below.

Clear PVC insulating cover for LRT series



CBB 3344

Clear PVC insulating cover for LRT series

Clear insulating boot protects connections.

- Accommodates six- and eight-outlet connectors for 5/8" or 1" studs

Cat. no.	L (in.)	H (in.)
CBB 3344	4	4¾

Stud-mount transformer connectors

Aluminum quick-disconnect transformer connectors – LRT-W, LRT-X and LRT series



LRT 4458 W



LRT 4458 X



LRT 2258

Compact design halves cantilever stress and doubles cable capacity.

- LRT-W Series features fully insulated transformer connector to protect connections
- LRT-X Series features clear deadfront insulator for safe and time-saving installations and disconnects; locks in place by raised set screws or installation of the first conductor
- RUS Accepted

Aluminum quick-disconnect transformer connectors

Cat. no.	Cable range (AWG or kcmil)	Outlets	Stud size (in.)	L (in.)	H (in.)
LRT-W series – Fully insulated with Flood-Seal® rockets					
LRT 2258 W	#12–350	4	5/8	2	2½
LRT 3358 W		6		3	
LRT 4458 W		8		4	
LRT 2210 W		4	1	2	
LRT 3310 W		6		3	
LRT 4410 W		8		4	
LRT-X series – Fully insulated					
LRT 2258 X	#12–350	4	5/8	2	4⅞
LRT 3358 X		6		3	
LRT 4458 X		8		4	
LRT 2210 X		4	1	2	
LRT 3310 X		6		3	
LRT 4410 X		8		4	
LRT series – Bare bar					
LRT 2258	#12–350	4	5/8	2	2½
LRT 3358		6		3	
LRT 4458		8		4	
LRT 2210		4	1	2	
LRT 3310		6		3	
LRT 4410		8		4	

Note: For oxide-inhibitor option, add "-C" suffix to the catalog number. For a clear PVC insulating cover, see below.

Clear PVC insulating cover for LRT series



CBB 3344

Clear insulating boot protects connections.

- Accommodates six- and eight-outlet connectors for 5/8" or 1" studs to match the transformer connector you have

Clear PVC insulating cover for LRT series

Cat. no.	L (in.)	H (in.)
CBB 3344	4	4¼

Stud-mount transformer connectors

Aluminum Flood-Seal® 95 series screw-on transformer connectors

For use with aluminum or copper lugs up to 350 kcmil.

- PVC-insulated aluminum body keeps out moisture while maintaining high conductivity
- Internal/external threaded bushing adapter included with FTU 95 series enables removal of connector without disassembling individual cables

- Dual-rated for use with aluminum or copper lugs from #8 to 350 kcmil
- All Flood-Seal connectors comply with ANSI C119.4 standards

FT 95 series

Cat. no.	Outlets	L (in.)	Stud size (in.)
FT 95-2	2	4	5/8
FT 95-3	3	5½	
FT 95-4	4	7	
FT 95-5	5	8½	
FT 95-6	6	10	
FT 95-44*	8	7	
FT 95-55*	10	8½	
FT 95-66*	12	10	
FT 95-2-1	2	4	1
FT 95-3-1	3	5½	
FT 95-4-1	4	7	
FT 95-5-1	5	8½	
FT 95-6-1	6	10	
FT 95-44-1*	8	7	
FT 95-55-1*	10	8½	
FT 95-66-1*	12	10	

FTU 95 series with disconnectable bushing adapter

Cat. no.	Outlets	L (in.)	Stud size (in.)
FTU 95-2	2	4	5/8
FTU 95-3	3	5½	
FTU 95-4	4	7	
FTU 95-5	5	8½	
FTU 95-6	6	10	
FTU 95-44*	8	7	
FTU 95-55*	10	8½	
FTU 95-66*	12	10	
FTU 95-2-1	2	4	1
FTU 95-3-1	3	5½	
FTU 95-4-1	4	7	
FTU 95-5-1	5	8½	
FTU 95-6-1	6	10	
FTU 95-44-1*	8	7	
FTU 95-55-1*	10	8½	
FTU 95-66-1*	12	10	

Diagram

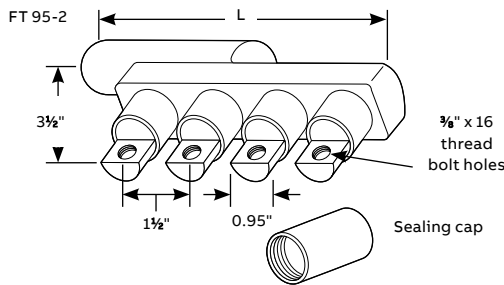

Diagram

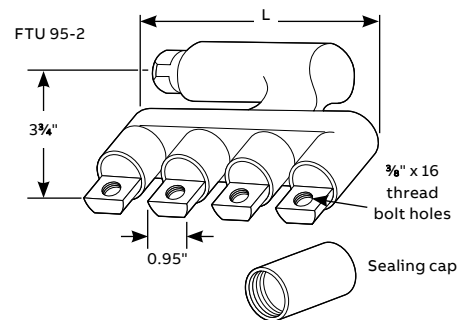

* Double-row configuration.

Note: All transformer connectors include a jam nut and EPDM rubbing bushing stud cover. All outlets except one are factory-sealed with removable sealing caps. For complete assembly with CS 2011 insulating rockets, add "-AWR" suffix to the catalog number. For other accessories, see pages 44-45.

Flood-Seal rockets sold separately

01 CS 2011



01

Stud-mount transformer connectors

Aluminum Flood-Seal® 125 series screw-on transformer connectors



FTU 125-5

For use with aluminum or copper lugs up to 500 kcmil.

- Heavy PVC-insulated aluminum body keeps out moisture while maintaining high conductivity
- Offset handle design positions cable weight close to tank wall
- Outlets equipped with ½" hex-head bolts with captive Belleville washers accept standard one-hole or two-hole NEMA aluminum or copper lugs
- Comply with ANSI C119.4 specifications
- RUS Accepted

Aluminum Flood-Seal 125 series screw-on transformer connectors

Cat. no.	Figure no.	C (in.)	L† (in.)	Outlets	Stud size (in.)
FTU 125-2	1	3 7/8	4 7/8	2	5/8
FTU 125-3	1	3 7/8	6 5/8	3	
FTU 125-4	2	5 3/16	7 1/8	4	
FTU 125-5	2	5 3/16	9	5	
FTU 125-6	2	5 3/16	10 3/4	6	
FTU 125-44*	2	5 3/16	7 1/8	8	
FTU 1-125-2	1	3 7/8	4 7/8	2	1
FTU 1-125-3	1	3 7/8	6 5/8	3	
FTU 1-125-4	2	5 3/16	7 1/8	4	
FTU 1-125-5	2	5 3/16	9	5	
FTU 1-125-6	2	5 3/16	10 3/4	6	
FTU 1-125-44*	2	5 3/16	7 1/8	8	

Cat. no.	Figure no.	C (in.)	L† (in.)	Outlets	Stud size (in.)
FTU 2 N	3	5 5/8	4 7/8	2	5/8
FTU 3 N	3	5 7/8	6 5/8	3	
FTU 4 N	4	6 15/16	7 1/8	4	
FTU 5 N	4	6 15/16	9	5	
FTU 6 N	4	6 15/16	10 3/4	6	
FTU 44 N*	4	6 15/16	7 1/8	8	
FTU 1-2 N	3	5 5/8	4 7/8	2	1
FTU 1-3 N	3	5 5/8	6 5/8	3	
FTU 1-4 N	4	6 15/16	7 1/8	4	
FTU 1-5 N	4	6 15/16	9	5	
FTU 1-6 N	4	6 15/16	10 3/4	6	
FTU 1-44 N*	4	6 15/16	7 1/8	8	

Diagrams

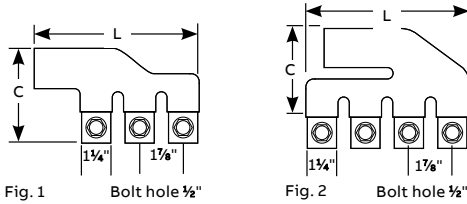

Diagrams

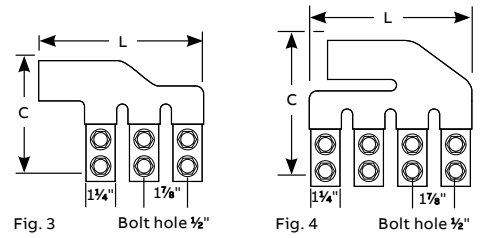

* Double-row configuration. † L is the same for 1-hole and 2-hole versions. Note: For complete assembly with CS 2011 insulating rockets, add "-AWR" suffix to the FTU catalog number. For complete assembly with CSN 2011 insulating rockets, add "-AWR" suffix to the FTU-N catalog number. For other accessories, see pages 46-47. All transformer connectors include threaded bushing adapter, bushing stud cover, jam nut and lug mounting hardware.

Flood-Seal rockets sold separately

- 01 CS 2011
- 02 CSN 2011



← For 1-hole outlet connectors



← For 2-hole outlet connectors

Stud adapter kit

- Works with 5/8" and 1" stud sizes
- Compatible with Flood-Seal 95 and 125 series screw-on transformer connectors

Cat. no.	Stud size (in.)
2135 K	5/8
2250-1 K	1

Note: Includes stud cover and jam nut.

Stud-mount transformer connectors

Copper screw-on transformer stud adapters



2043-10

Adapters for cable-to-stud connections.

- Made from pure electrolytic copper for high conductivity
- Marked with crimp area, installing dies and wire size for easy identification

Screw-on stud adapters

Cat. No.	Stud size (in.)	Cable size (AWG or kcmil)
2043-1	$\frac{5}{8}$ -11	350
2043-2	$\frac{1}{2}$ -13	350
2043-3	$\frac{3}{8}$ -16	350
2043-4	1-14	350
2043-5	$\frac{3}{4}$ -16	4/0
2043-6	1-8	350
2043-7	$\frac{1}{2}$ -13	4/0
2043-8	$\frac{1}{2}$ -13	250
2043-9	$\frac{5}{8}$ -11	250
2043-10	$\frac{5}{8}$ -11	500

Note: For variations or unlisted sizes, please consult your ABB representative.

Pad-mount transformer connectors

Copper tin-plated transformer stud adapters

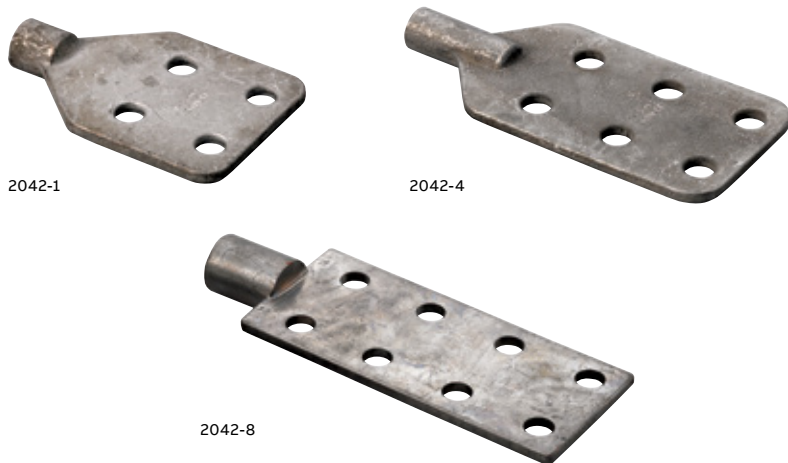

Adapters for NEMA pad-style connections.

- Made from pure electrolytic copper for high conductivity
- Tin plated to resist corrosion
- Dual-rated to accept standard aluminum or copper NEMA lugs

Four-hole transformer stud adapters

	Cat. no.	Stud size (in.)
Diagrams	2042-1	$\frac{5}{8}$ -11
	2042-2	1-14
	2042-3	$\frac{1}{2}$ -13

Note: For variations or unlisted sizes, please consult your ABB representative.

Six-hole transformer stud adapters

	Cat. no.	Stud size (in.)
Diagrams	2042-4	$\frac{5}{8}$ -11
	2042-5	1-14
	2042-6	$1\frac{1}{4}$ -12
	2042-7	$1\frac{1}{2}$ -12

Eight-hole transformer stud adapters

	Cat. no.	Stud size (in.)
Diagrams	2042-8	$\frac{5}{8}$ -11
	2042-9	1-14
	2042-10	$1\frac{1}{4}$ -12
	2042-11	$1\frac{1}{2}$ -12

Pad-mount transformer connectors

Aluminum lay-in transformer spade connectors – ABK™ and AK™ series



ABK 1750



ABK 3750



AK 600 N

The slide-out keeper minimizes the hassle and hazards of forcing cables into closed ports.

- Require only a cable stripper and Allen hex wrench – no crimping tools or dies or other special tools needed for installation
- Transformer changes require only the connector to be unbolted from the spade – no need to disconnect all the conductors, as with compression systems
- Dual-rated to use with aluminum or copper cable
- Double set screws maximize contact area and mechanical characteristics
- Ball-bottom screws ensure even force distribution in the cable/connector interface
- RUS Accepted

ABK series

Cat. no.	Outlets	Cable range (AWG or kcmil)	Length (in.)	Height (in.)	Mount holes
ABK 1600 DS	1	#2–600	1 ⁴ / ₆₄	6	2
ABK 4600 DS	4		6		4
ABK 6600 DS	6		8 ²⁹ / ₃₂		8
ABK 1750	1	1/0–750	1 ⁵³ / ₆₄	6 ³ / ₁₆	2
ABK 2750	2		3 ¹⁵ / ₁₆		4
ABK 3750	3		5 ³ / ₃₂		6
ABK 4750	4		6 ⁴⁷ / ₆₄		8
ABK 6750	6		10		12
ABK 8750	8		13 ¹ / ₂		16
ABK 11000	1	1/0–1000	1 ⁵ / ₈		2
ABK 11000 SSN*	1		1 ⁵ / ₈		2
ABK 21000	2		3 ⁵ / ₈		4
ABK 31000	3		5 ¹⁵ / ₁₆		6
ABK 41000	4		7		8
ABK 61000	6		10 ³ / ₈		16
ABK 81000	8		13 ³ / ₄		18

* Slotted pad holes. Note: For tin-plating option, add *-TN* suffix to the catalog number.

ABK ML series – Tall pad design

Cat. no.	Outlets	Cable range (AWG or kcmil)	Length (in.)	Height (in.)	Mount holes
ABK 1750-ML	1	1/0–750	1 ⁵³ / ₆₄	8 ¹ / ₂	3
ABK 2750-ML	2		3 ¹⁵ / ₁₆		6
ABK 3750-ML	3		5 ³ / ₃₂		9
ABK 4750-ML	4		6 ⁴⁷ / ₆₄		12
ABK 6750-ML	6		10		18
ABK 8750-ML	8		13 ¹ / ₂		24

AK series

Cat. no.	Outlets	Cable range (AWG or kcmil)
AK 600 N	1	#2–600

Pad-mount transformer connectors

Aluminum lay-in transformer spade connectors – ABK™ 1000 and ABK™ 7024 series



ABK 441000



ABK 81-7024 L



ABK 881-7024

Save time and labor by placing cables into the keeper slot.

- Cables are easily placed into the keeper slot to minimize the hassle and hazards of having to force cables into the closed cable ports found on conventional mechanical connectors – you save time and labor
- ABK 7024 series comes standard with street light outlet and stainless steel mounting hardware
- Require only a cable stripper and Allen hex wrench – no crimping tools or dies or other special tools are needed for installation
- Transformer changes require only the connector to be unbolted from the spade – no need to disconnect all the conductors, as with compression systems
- Dual-rated for use with aluminum or copper cable
- Ball-bottom screws ensure even force distribution in the cable/connector interface
- RUS Accepted

01 ABK 7024 series support kit

- (1) 30" fiberglass support rod
- (4) ½"-13 stainless steel carriage bolts
- (4) ½" stainless steel flat washers
- (4) ½" stainless steel lock washers
- (4) ½" silicone bronze nuts
- (2) tin-plated support brackets

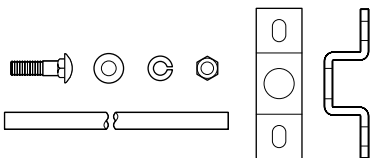

01

ABK 1000 series – Back-to-back

Cat. no.	Outlets	Conductor range (AWG or kcmil)
ABK 221000	4	1/0-1000
ABK 331000	6	
ABK 441000	8	
ABK 661000	12	
ABK 881000	16	

Note: For oxide-inhibitor option, add "-C" suffix to the catalog number. For SB Series insulating covers, see page 34.

ABK 7024 series – Single row

Cat. no.	Outlets	Conductor range (AWG or kcmil)
ABK 81-7024 R	8	1/0-1000
ABK 81-7024 L	8	

ABK 7024 series – Back-to-back

Cat. no.	Outlets	Conductor range (AWG or kcmil)
ABK 881-7024	16	1/0-1000

Pad-mount transformer connectors

Aluminum quick-disconnect lay-in transformer connectors – ZBKW™ series

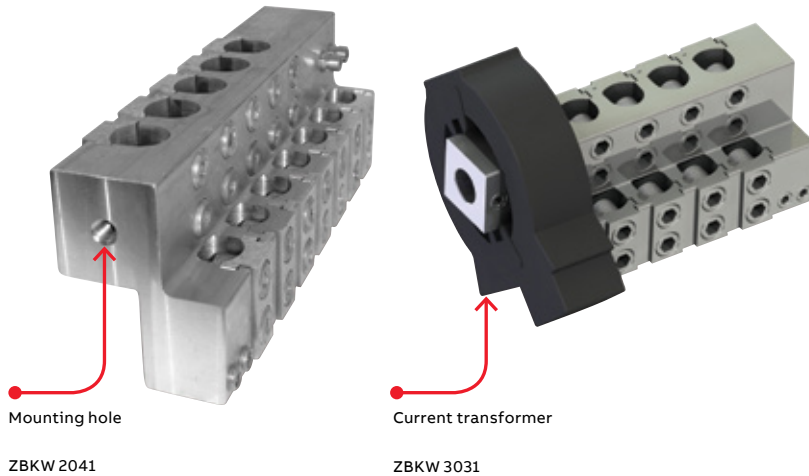

Get two times the cable capacity in the same length.

- Cables are easily placed into the keeper slot to minimize the hassle and hazards of having to force cables into the closed cable ports found on conventional mechanical connectors – you save time and labor
- Compact Zeebar® design halves cantilever stress and doubles cable capacity
- EZ Torque® stud screws make mounting to the transformer stud easy and shear off at the proper torque
- Made from aluminum for high strength and high conductivity
- Dual-rated for use with aluminum or copper cable
- Quick disconnects make connector easy to install or remove
- Wide cable range provides connections for cables ranging from 1/0 to 1000 kcmil
- Two #12 to 1/0 street light outlets provide added versatility for additional connections
- RUS Accepted

ZBKW 2 SLM series

Cat. no.	Conductor range (AWG or kcmil)	Outlets	Size (in.)
ZBKW 2041-1-2 SLM	1/0–1000 main, (2) #12–1/0 street light	6	8.2
ZBKW 2041-1-2 SLRM		6	8.2
ZBKW 3051-1-2 SLM		8	9.9
ZBKW 3051-1-2 SLRM		8	9.9
ZBKW 4061-1-2 SLM		10	11.5
ZBKW 4061-1-2 SLRM		10	11.5
ZBKW 5071-1-2 SLM		12	13.2
ZBKW 5071-1-2 SLRM		12	13.2

Includes 1" transformer stud, two street light outlets and mounting support provision.

ZBKW 2 SLCTM series

Cat. no.	Conductor range (AWG or kcmil)	Outlets	Size (in.)
ZBKW 3031-1-2 SLCTM	1/0–1000 main, (2) #12–1/0 street light	6	9.9
ZBKW 3031-1-2 SLRCTM		6	9.9
ZBKW 3041-1-2 SLCTM		8	11.5
ZBKW 3041-1-2 SLRCTM		8	11.5

Includes 1" transformer stud, two street light outlets, current transformer and mounting support provision.

Note: For 1¼" stud, change "-1" suffix to "-1.25." For 1½" stud, change "-1" suffix to "-1.5."

Pad-mount transformer connectors

Aluminum lay-in transformer spade connectors – ZBK™ series



ZBK 6067

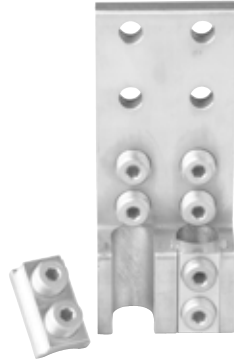

ZBK 4047

Compact Zeebar® design halves cantilever stress and doubles cable capacity.

- Slide-out keeper minimizes the hassle and hazards of having to force cables into the closed cable ports found on conventional mechanical connectors – you save time and labor
- Easy transformer change-out connector can be unbolted from the spade without the need to disconnect the service conductors
- Made from aluminum for high strength and high conductivity
- Dual-rated for use with aluminum or copper cable
- Wide cable range provides connections for cables ranging from 1/0 AWG to 750 kcmil or from 1/0 AWG to 1000 kcmil
- RUS Accepted

ZBK series

Cat. no.	Conductor range (AWG or kcmil)	Outlets	Mount holes
ZBK 1017	1/0–750	2	2
ZBK 2027		4	4
ZBK 3037		6	6
ZBK 4047		8	8
ZBK 6067		12	12
ZBK 8087		16	16
ZBK 2021	1/0–1000	4	4
ZBK 3031		6	6
ZBK 4041		8	8
ZBK 6061		12	12
ZBK 8081		16	16

Note: For oxide-inhibitor option, add "-C" suffix to the catalog number.

For SB Series insulating boots, see page 34.

For tin-plating option, add "-TN" suffix to the catalog number.

Pad-mount transformer connectors

Aluminum transformer spade connectors – ABT™ single set-screw series



ABT 4350-48



ABT 6350

High-strength aluminum alloy maximizes electrical and mechanical performance.

- Ball-bottom screws ensure maximum conductor contact pressure and break up interstrand oxides
- Dual-rated to accept copper or aluminum conductors
- Meets or exceeds ANSI C119.4 specifications

ABT series – Single-row mounting holes

Cat. no.	Outlets	Length (in.)	Mounting holes	Conductor range (AWG or kcmil)
ABT 440-48	4	4 ³ / ₄	3	#6–250
ABT 640-48	6	5 ¹⁵ / ₁₆	4	
ABT 840-48	8	7 ¹⁵ / ₁₆	4	
ABT 4350-48	4	4 ⁵ / ₈	3	#12–350
ABT 6350-48	6	6 ¹ / ₂	4	
ABT 8350-48	8	8 ¹ / ₄	5	
ABT 4500-48	4	4 ⁹ / ₁₆	3	#6–500
ABT 6500-48	6	6 ¹ / ₂	4	
ABT 8500-48	8	9 ¹ / ₄	6	

Note: For oxide-inhibitor option, add “-C” suffix to the catalog number.

For SB series insulating covers, see page 34.

For tin-plating option, add “-TN” suffix to the catalog number.

ABT series – Double-row mounting holes

Cat. no.	Outlets	Length (in.)	Mounting holes	Conductor range (AWG or kcmil)
ABT 440	4	4 ³ / ₄	6	#6–250
ABT 640	6	5 ¹⁵ / ₁₆	8	
ABT 840	8	7 ¹⁵ / ₁₆	8	
ABT 2350	2	3	4	#12–350
ABT 3350	3	3	4	
ABT 4350	4	4 ⁵ / ₈	6	
ABT 6350	6	6 ¹ / ₂	8	
ABT 8350	8	8 ¹ / ₄	10	
ABT 2500	2	3	4	#6–500
ABT 3500	3	3	4	
ABT 4500	4	4 ⁹ / ₁₆	6	
ABT 5500	5	5 ²³ / ₃₂	8	
ABT 6500	6	6 ¹ / ₂	8	
ABT 8500	8	9 ¹ / ₄	12	

Note: For oxide-inhibitor option, add “-C” suffix to the catalog number.

For SB series insulating covers, see page 34.

For tin-plating option, add “-TN” suffix to the catalog number.

Pad-mount transformer connectors

Aluminum transformer spade connectors – ABT™ double set-screw series



ABT 4500 DS

High-strength aluminum alloy maximizes electrical and mechanical performance.

- Ball-bottom screws ensure maximum conductor contact pressure and break up interstrand oxides
- Dual-rated to accept copper or aluminum conductors
- Meets or exceeds ANSI C119.4 specifications

ABT series – Double-set screw

Cat. no.	Outlets	Length (in.)	Mounting holes	Conductor range (AWG or kcmil)
ABT 1500 DS	1	1 $\frac{1}{4}$	2	#6–500
ABT 2500 DS	2	3	4	
ABT 3500 DS	3	3 $\frac{5}{8}$	4	
ABT 4500 DS	4	4 $\frac{3}{4}$	6	
ABT 5500 DS	5	5 $\frac{23}{32}$	8	
ABT 6500 DS	6	6 $\frac{1}{2}$	8	
ABT 8500 DS	8	9 $\frac{3}{16}$	12	
ABT 1750	1	1 $\frac{1}{2}$	2	1/0–750
ABT 2750	2	3	4	
ABT 3750	3	4 $\frac{3}{4}$	6	
ABT 4750	4	6 $\frac{1}{2}$	8	
ABT 5750	5	6 $\frac{1}{2}$	8	
ABT 6750	6	8 $\frac{1}{4}$	10	
ABT 8750	8	10 $\frac{11}{16}$	12	
ABT 11000	1	1 $\frac{3}{4}$	2	1/0–1000
ABT 21000	2	3	4	
ABT 31000	3	4 $\frac{3}{4}$	6	
ABT 41000	4	6 $\frac{1}{2}$	8	
ABT 61000	6	9 $\frac{3}{4}$	12	
ABT 81000	8	12 $\frac{1}{4}$	12	

Note: For oxide-inhibitor option, add “-C” suffix to the catalog number.

For tin-plating option, add “-TN” suffix to the catalog number.

For SB series insulating covers, see page 34.

Pad-mount transformer connectors

Aluminum transformer spade connectors – ZBT™ series

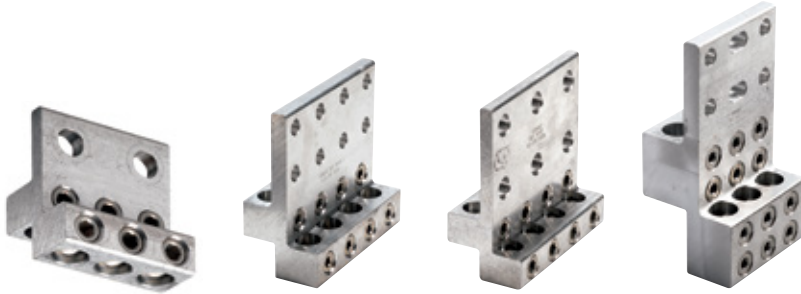

ZBT 3033-48

ZBT 4047

ZBT 4043

ZBT 3037 DS

The quicker-installation alternatives to compression lugs.

- Compact Zeebar® design halves cantilever stress and doubles cable capacity
- High-strength aluminum alloy maximizes electrical and mechanical performance
- Ball-bottom screws ensure maximum conductor contact pressure and break up interstrand oxides
- Dual-rated to accept copper or aluminum conductors
- Meets or exceeds ANSI C119.4 specifications

ZBT series – Single-row mounting holes

Cat. no.	Cable range (AWG or kcmil)	Outlets	Length (in.)	Mounting holes
ZBT 1013-48	#12–350	2	$3\frac{1}{32}$	1
ZBT 2023-48		4	2	1
ZBT 3033-48		6	3	2
ZBT 4043-48		8	$4\frac{3}{4}$	3
ZBT 5053-48		10	$4\frac{3}{4}$	3
ZBT 6063-48		12	$6\frac{1}{2}$	4

ZBT series – Double-row mounting holes

Cat. no.	Cable range (AWG or kcmil)	Outlets	Length (in.)	Mounting holes
ZBT 1013	#12–350	2	$3\frac{1}{32}$	2
ZBT 2023		4	2	2
ZBT 3033		6	3	4
ZBT 4043		8	$4\frac{3}{4}$	6
ZBT 5053		10	$4\frac{3}{4}$	6
ZBT 6063		12	$6\frac{1}{2}$	8
ZBT 1017	1/0–750	2	$1\frac{5}{8}$	2
ZBT 2027		4	3	4
ZBT 4047		8	$6\frac{1}{2}$	8
ZBT 5057		10	$8\frac{1}{4}$	10
ZBT 6067		12	$8\frac{1}{4}$	10
ZBT 8087		16	11	12
ZBT 1717 DS*		2	$1\frac{5}{8}$	2
ZBT 2027 DS*		4	3	4
ZBT 4047 DS*		8	$6\frac{1}{2}$	8
ZBT 5057 DS*		10	$8\frac{1}{4}$	10
ZBT 6067 DS*		12	$8\frac{1}{4}$	10
ZBT 8087 DS*		16	11	12
ZBT 1011*	1/0–1000	2	$1\frac{5}{8}$	2
ZBT 2021*		4	$3\frac{5}{16}$	4
ZBT 3031*		6	5	6
ZBT 4041*		8	$6\frac{11}{16}$	8
ZBT 8081*		16	$13\frac{7}{16}$	16

*Two set-screws per outlet. Note: For oxide-inhibitor option, add “-C” suffix to the catalog number. For SB series insulating covers, see page 34. For tin-plating option, add “-TN” suffix to the catalog number.

Pad-mount transformer connectors

Aluminum transformer spade connectors – ABN™ series



ABN 4350

For installations on standard NEMA spade terminals.

- High-strength aluminum alloy maximizes electrical and mechanical performance
- Dual-rated to accept aluminum or copper conductors
- Ball-bottom screws ensure maximum conductor contact pressure and break up interstrand oxides
- Meets or exceeds ANSI C119.4 specifications

ABN series

Cat. no.	Cable range (AWG or kcmil)	Outlets	L (in.)	Boot no.
ABN 240	#6–250	2	4 ³ / ₄	SB 17
ABN 340		3	5 ¹ / ₂	SB 17
ABN 440		4	6 ⁵ / ₁₆	SB 11
ABN 540		5	7 ¹ / ₁₆	SB 11
ABN 640		6	7 ⁷ / ₈	SB 11
ABN 740		7	8 ⁵ / ₈	SB 14
ABN 840		8	9 ⁷ / ₁₆	SB 14
ABN 2350	#6–350	2	4 ¹⁵ / ₁₆	SB 17
ABN 3350		3	5 ⁷ / ₈	SB 11
ABN 4350		4	6 ³ / ₄	SB 11
ABN 5350		5	7 ¹¹ / ₁₆	SB 11
ABN 6350		6	8 ⁹ / ₁₆	SB 14
ABN 7350		7	9 ¹ / ₂	SB 14
ABN 8350		8	10 ⁷ / ₁₆	2160
ABN 2500	#2–500	2	5 ⁵ / ₁₆	SB 17
ABN 3500		3	6 ⁵ / ₁₆	SB 11
ABN 4500		4	7 ⁵ / ₁₆	SB 11
ABN 5500		5	8 ⁵ / ₁₆	SB 14
ABN 6500		6	9 ⁵ / ₁₆	2160
ABN 7500		7	10 ⁵ / ₁₆	2163
ABN 8500		8	11 ⁵ / ₁₆	2163-3
ABN 2750	1/0–750	2	5 ¹⁵ / ₁₆	2120
ABN 3750		3	7 ¹ / ₄	2120
ABN 4750		4	8 ⁵ / ₈	2120
ABN 5750		5	9 ¹⁵ / ₁₆	2160
ABN 6750		6	11 ¹ / ₄	2160
ABN 7750		7	12 ⁵ / ₈	2163-3
ABN 8750		8	13 ¹⁵ / ₁₆	2163-3

Note: For oxide-inhibitor option, add “-C” suffix to the catalog number.

For street light-outlet option, add “-SL” suffix to the catalog number.

For tin-plating option, add “-TN” suffix to the catalog number.

Pad-mount transformer connectors

Aluminum Flood-Seal® 125 series transformer spade connectors



FTN 125-44N



FTN 125-4N

For deadfront pad-mount transformers with four-hole NEMA spade secondary bushings.

- Provide maximum contact to ensure cooler operating, more reliable joints
- Dual-rated for use with aluminum or copper cable ranging from #8 AWG to 500 kcmil
- Outlets equipped with ½" plated steel hex-head bolts with captive Belleville washers to accept standard one-hole or two-hole NEMA aluminum or copper lugs
- All Flood-Seal connectors comply with ANSI C119.4 specifications

1-hole outlets

Cat. no.	Outlets	L (in.)
FTN 125-2	2	4
FTN 125-3	3	4 ⁷ / ₈
FTN 125-4	4	6
FTN 125-5	5	7 ⁷ / ₈
FTN 125-6	6	7 ⁷ / ₈
FTN 125-44*	8	6

2-hole outlets

Cat. no.	Outlets	L (in.)
FTN 125-2N	2	4
FTN 125-3N	3	4 ⁷ / ₈
FTN 125-4N	4	6
FTN 125-5N	5	7 ⁷ / ₈
FTN 125-6N	6	7 ⁷ / ₈
FTN 125-44N*	8	6

* Double-row configuration.

Note: For complete assembly with CS 2011 insulating rockets, add "-AWR" suffix to the FTN catalog number.
For complete assembly with CSN 2011 insulating rockets, add "-AWR" suffix to the FTN-N catalog number.

Pad-mount transformer connectors

Aluminum Flood-Seal® 175 series transformer spade connectors



FTN 175-4R



FTN 175-22

For deadfront pad-mount transformers with four-hole NEMA spade secondary bushings.

- Flood-Seal connectors permit the use of aluminum or copper standard side-formed two-hole lugs
- Flood-Seal EPDM rubber insulating sleeves are available to fully insulate outlets
- All outlets are provided with ½" plated steel hex-head bolts and captive Belleville washers
- Cable range from 4/0 AWG to 1000 kcmil aluminum or copper
- Maximum contact ensures cooler operating, more reliable connections
- All Flood-Seal connectors meet or exceed ANSI C119.4 specifications

Single-row style

Diagrams	Cat. no.	Spade	Outlets	Length (in.)
<p>NEMA spade PVC 6 L NEMA spaced All outlets 2½" on center</p>	FTN 175-4R	Right hand	4	9¼"
	FTN 175-4L	Left hand	4	9¼"
	FTN 175-5R	Right hand	5	11¾"
	FTN 175-5L	Left hand	5	11¾"
	FTN 175-6R	Right hand	6	14¼"
	FTN 175-6L	Left hand	6	14¼"

Double-row style

Diagrams	Cat. no.	Outlets	Length (in.)
<p>NEMA pad PVC insulation 4 4 6¾ L All outlets 2½" on center</p>	FTN 175-22	4	4¼"
	FTN 175-33	6	6¾"
	FTN 175-44	8	9¼"
	FTN 175-55	10	11¾"
	FTN 175-66	12	14¼"

Pad-mount transformer connectors

NEMA transformer spade adapters

The options you need for a variety of connections.

- Adapters for standard and four-hole NEMA transformer pads
- Cables are disconnectable to make swaps and changes easier
- Dual-rated to accept copper or aluminum lugs



TSC 4-6

TSC 4 series – Aluminum

Cat. no.	Bolt holes	Spade thickness (in.)
TSC 4-6	6	$\frac{3}{8}$
TSC 4-8	8	
TSC 4-10	10	$\frac{3}{4}$
TSC 4-12	12	

Note: For tin-plating option, add "-TN" suffix to the catalog number.
For custom configurations, please consult your ABB representative.



TSC 8

TSC series – Aluminum

Cat. no.	Bolt holes	Spade thickness (in.)
TSC 6	6	$\frac{3}{8}$
TSC 8	8	
TSC 10	10	$\frac{3}{4}$
TSC 12	12	

Note: For tin-plating option, add "-TN" suffix to the catalog number.
For custom configurations, please consult your ABB representative.

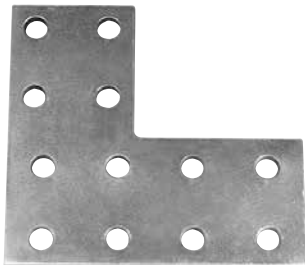

CTSC 4-12

CTSC 4 series – Copper

Cat. no.	Bolt holes	Spade thickness (in.)
CTSC 4-6	6	$\frac{1}{4}$
CTSC 4-8	8	
CTSC 4-10	10	$\frac{1}{2}$
CTSC 4-12	12	

Note: For tin-plating option, add "-TN" suffix to the catalog number.
For custom configurations, please consult your ABB representative.

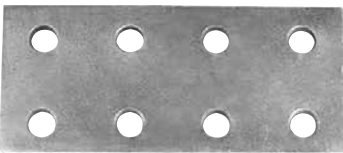

CTSC 8

CTSC series – Copper

Cat. no.	Bolt holes	Spade thickness (in.)
CTSC 6	6	$\frac{1}{4}$
CTSC 8	8	
CTSC 10	10	$\frac{1}{2}$
CTSC 12	12	

Note: For custom configurations, please consult your ABB representative.

Network protector connectors

Flood-Seal® 175 series clamp-on style transformer and network protection connectors



Convenient multiple-tap connections to power transformers and network protectors.

- Compact design conserves vault and manhole space – and often eliminates the need for auxiliary buses
- Clamp-style base provides 3¼" of stud contact and eliminates the need for a jam nut
- Rubber gasket ensures secure closure between connector halves
- All NEMA-drilled aluminum alloy outlets equipped with plated hex-head bolts and captive Belleville washers to accept two-hole NEMA lugs up to 1000 kcmil, vertical or horizontal

Vertical cable leads

Diagrams	Cat. no.	Outlets	Stud size (in.)
	FTT 44-175-15	8	1½
	FTT 44-175-30	8	3

Rubber gasket provides secure closure between connector halves

Note: For copper connectors, add "-CU" suffix to the catalog number.
 For complete assembly with insulating rockets, add "-AWR" suffix to the catalog number.
 For special applications or greater number of outlets than those listed, please consult your ABB representative.

Horizontal cable leads

Diagrams	Cat. no.	Outlets	Height (in.)	Stud size (in.)
	FTH 22-175-15	4	9¾	1½
	FTH 33-175-15	6	11⅞	
	FTH 44-175-15	8	14¾	
	FTH 55-175-15	10	16⅞	
	FTH 22-175-30	4	9¾	3
	FTH 33-175-30	6	11⅞	
	FTH 44-175-30	8	14¾	
	FTH 55-175-30	10	16⅞	

Rubber gasket provides secure closure between connector halves

Note: For copper connectors, add "-CU" suffix to the catalog number.
 For complete assembly with insulating rockets, add "-AWR" suffix to the catalog number.
 For special applications or greater number of outlets than those listed, please consult your ABB representative.

Drop-on insulating boots

Insulating boots for transformer spade connectors

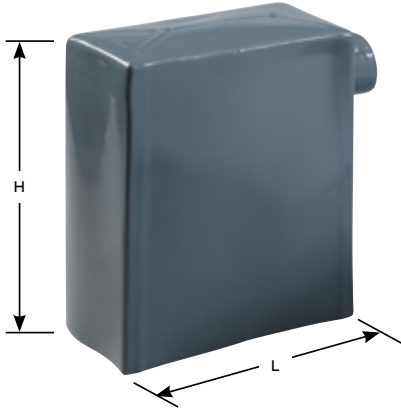

SB 2159
(PVC)

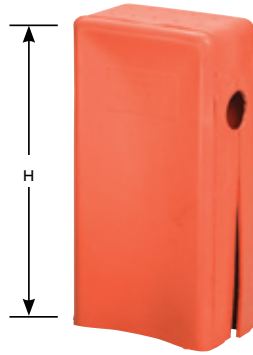

BBV4N
(EPDM)

Insulating boots for harsh environments.

- BBV4N features EPDM rubber flexi-boot – will not crack from cold embrittlement, will not cold flow and will not soften with heat
- BBV4N features flexible locking ribs to prevent accidental removal of EPDM boot
- PVC boots available
- SB series is RUS Accepted

Insulating boots for transformer spade connectors

Cat. no.	Length (in.)	Width (in.)	Height (in.)
SB series			
SB 2144	3 $\frac{3}{4}$	4 $\frac{1}{2}$	9
SB 2147	5 $\frac{1}{2}$	2 $\frac{1}{2}$	6 $\frac{7}{8}$
SB 2151	5 $\frac{1}{2}$	4	12
SB 17	5 $\frac{15}{16}$	2 $\frac{3}{4}$	3 $\frac{3}{4}$
SB 2163-6	7	4 $\frac{5}{8}$	8 $\frac{7}{8}$
SB 2163-7	8	3	7 $\frac{7}{8}$
SB 11	8 $\frac{1}{8}$	2	2 $\frac{1}{16}$
SB 2120	8 $\frac{3}{4}$	2 $\frac{1}{2}$	5 $\frac{1}{5}$
SB 2163-12	8 $\frac{3}{4}$	5	8 $\frac{1}{8}$
SB 2163-2	8 $\frac{3}{4}$	5	9
SB 2157	9 $\frac{3}{4}$	2 $\frac{3}{4}$	7 $\frac{3}{4}$
SB 2159	9 $\frac{3}{4}$	4 $\frac{5}{8}$	11 $\frac{3}{4}$
SB 14	9 $\frac{15}{16}$	2	2 $\frac{1}{16}$
SB 2160	12	2 $\frac{3}{4}$	5 $\frac{7}{8}$
SB 2163-3	12 $\frac{3}{8}$	5 $\frac{3}{16}$	11 $\frac{7}{8}$
SB 2163-10	13 $\frac{3}{4}$	5	7 $\frac{3}{4}$
SB 2163-4	14	5 $\frac{1}{2}$	11 $\frac{7}{8}$
BBV series			
BBV4N	4 $\frac{3}{8}$	2 $\frac{3}{4}$	10

Note: For boot sizes not listed, please consult your ABB representative.
PVC boots available in black, gray, yellow or clear.

Flood-Seal® multi-port connectors

Aluminum Flood-Seal mechanical connectors



Save outlet space.

These connectors feature the Sweetheart® outlet configuration that nests two equal-sized service cables from #6 to 2/0 AWG or two different-sized cables from #2 to 2/0 AWG, saving you outlet space and consequent cost. Unique cable outlets permit the use of street light wire either in original construction or as a later addition. Connectors are dual-rated, PVC insulated, supplied with insulating rockets and prefilled with oxide inhibitor.

- Aluminum-alloy connector construction for high strength and high conductivity; dual-rated for use with copper or aluminum cable
- Exceed ANSI C119.1 and C119.4 requirements and are RUS Accepted
- All connectors are 100% hi-pot tested at 4000 V for 60 seconds

Flood-Seal mechanical connectors

Diagrams	Cat. no.	Cable range feeder outlet S/L (AWG or kcmil)	Outlets	L (in.)
	SHC 21	#6-2/0	2	3 3/4
	SHC 22	#6-350	2	3 3/4
	SHC 121	#14 sol.-#6	3	5 1/4
	SHC 212		3	5 1/4

Note: In catalog number, 1 designates outlet with street light (S/L) option; 2 designates Sweetheart outlet. Sweetheart outlet nests two equal-sized service cables from #6 to 2/0 AWG or two different-sized cables from #2 AWG to 2/0. Feeder outlet houses cables from #6 AWG to 350 kcmil (cable range when using a street light tap is 1/0 AWG to 350 kcmil).

Flood-Seal mechanical connectors with street light option

Diagrams	Cat. no.	Cable range (AWG or kcmil)	Outlets	L (in.)
	SHC 2	#6-350	2	3 3/4
	SHC 3	#14 sol.-#6	3	5 1/4
	SHC 4		4	7
	SHC 5		5	8 7/8
	SHC 6		6	10 3/4
	SHC 8		8	14 1/2

Note: All outlets are provided with insulating rocket sleeves, with one sleeve having the street light capability. Cable range is 1/0 AWG to 350 kcmil when using a street light tap.

01 For EZ Torque® shear-head screws supplied in all outlets, add "-TS" suffix to the catalog number.



Flood-Seal mechanical 500 kcmil connectors

Diagrams	Cat. no.	Cable range (AWG or kcmil)	Outlets	L (in.)
	SHC 500-2	#2-500	2	3 7/8
	SHC 500-3		3	6 1/4
	SHC 500-4		4	8 3/8
	SHC 500-5		5	10 5/8
	SHC 500-6		6	12 7/8
	SHC 500-8		8	17 3/8

Flood-Seal® multi-port connectors

Aluminum Flood-Seal mechanical connectors – 4/0 series

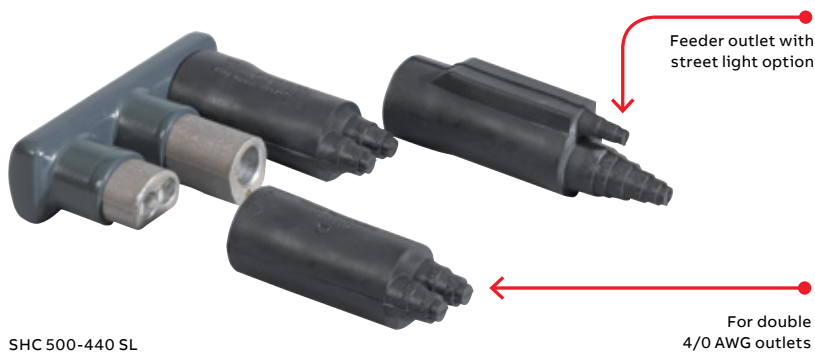

Save outlet space and use street light wire.

Aluminum Flood-Seal mechanical connectors feature ball-bottom screws that support the widest conductor range and aid in breaking up aluminum oxides. Wide-range cable outlets permit the use of street light wire either in original construction or as a later addition. Sweetheart® connectors are dual-rated, PVC insulated, supplied with insulating rockets and prefilled with oxide inhibitor.

- Dual-rated for use with a wide range of aluminum or copper cable
- Aluminum-alloy connector construction for high strength and high conductivity
- Sweetheart outlet configuration doubles cable capacity and halves space requirements
- Single-screw design with outlets sealed with Flood-Seal EPDM rockets
- Street light option supports the use of street light wire (#14 to #4 AWG)
- Exceed ANSI C119.1 and C119.4 requirements and Western Underground Committee Guidelines and are RUS accepted.
- All connectors are 100% hi-pot tested at 4000 V for 60 seconds

Mechanical connectors for 4/0 AWG outlets with 500 kcmil feeder

Diagrams	Cat. no.	Wire range (AWG or kcmil)	L (in.)	H (in.)
	SHC 500-240 SL	Tap #4-4/0	4½	4¾
	SHC 500-440 SL	Feeder #2-500	6¾	
	SHC 500-640 SL	S/L #14-#4	9¾	

Flood-Seal® multi-port connectors

Aluminum Flood-Seal twin-screw mechanical connectors



For direct burial or above-ground pedestal installation.

- Flood-Seal insulating rockets field tested in more than 10 million applications
- All connectors are 100% hi-pot tested at 4000 V for 60 seconds
- Prefilled with oxide inhibitor to prevent oxidation and keep out moisture
- Ball-bottom screws support the widest conductor range and aid in breaking up aluminum oxides
- Aluminum-alloy connector construction for high strength and high conductivity
- Dual-rated for use with a wide range of copper or aluminum conductors
- Exceed ANSI C119.1 and C119.4 requirements and Western Underground Committee Guidelines

350 kcmil series

Diagrams	One-way Cat. no.	Outlets one-way	Two-way Cat. no.	Outlets two-way	Length (in.)	Cable range (AWG or kcmil)
<p>One-way outlets</p>	UH 2 R	2	UH 22 R	4	3 1/4	#6-350
	UH 3 R	3	UH 33 R	6	5 1/4	
<p>Two-way outlets</p>	UH 4 R	4	UH 44 R	8	7	
	UH 5 R	5	UH 55 R	10	8 7/8	
	UH 6 R	6	UH 66 R	12	10 3/4	
	UH 8 R	8	UH 88 R	16	14 1/2	

01 For EZ Torque® shear-head screws supplied in all outlets, add “-TS” suffix to the catalog number.



01

500 kcmil series

Diagram	Cat. no.	Cable range (AWG or kcmil)	Outlets	L (in.)	H (in.)
	UH 500-2 R	#2-500	2	3 7/8	4 3/4
	UH 500-3 R		3	6 1/8	
	UH 500-4 R		4	8 3/8	
	UH 500-5 R		5	10 5/8	
	UH 500-6 R		6	12 7/8	
	UH 500-8 R		8	17 3/8	

Flood-Seal® multi-port connectors

Aluminum Flood-Seal twin-screw mechanical connectors – UH 750 series



Diagram

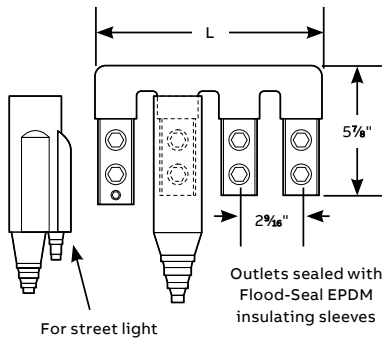

Versatile for direct burial or above-ground pedestals.

- Flood-Seal insulating rockets field tested in more than 10 million applications
- All connectors are 100% hi-pot tested at 4000 V for 60 seconds
- Street light outlet option – wide-range cable outlets support the use of street light wire
- Prefilled with oxide inhibitor to prevent oxidation and keep out moisture
- Aluminum-alloy connector construction for high strength and high conductivity
- Dual-rated to accept a wide range of copper or aluminum conductors
- Exceed ANSI C119.1 and C119.4 requirements as well as Western Underground Committee Guidelines

Submersible connector with street light outlet

Cat. no.	Outlets	Length (in.)	Cable range		Street light
			(AWG or kcmil)	Main (AWG or kcmil)	
UH 750-4 SLR	4	9½	1/0-750	#2-750	#14-#2
UH 750-6 SLR	6	14⅝	SL #14-#2		

Dual-outlet connectors with street light port



Diagram

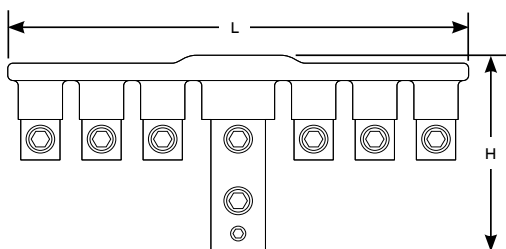

4/0 AWG outlets with 750 kcmil feeder

Cat. no.	Wire range (AWG or kcmil)		Outlets	L (in.)	H (in.)
	Feeder	Tap			
UH 750-240 SLR	1/0-750,	#12-4/0,	(2) 4/0 (1) 750	5½	5½
UH 750-440 SLR		S/L #14-#2	(4) 4/0 (1) 750	8½	
UH 750-640 SLR			(6) 4/0 (1) 750	11½	

350 kcmil outlets with 750 kcmil feeder

Cat. no.	Wire range (AWG or kcmil)		Outlets	L (in.)	H (in.)
	Feeder	Tap			
UH 750-235 SLR	1/0-750,	#6-350,	(2) 350 (1) 750	5⅝	6
UH 750-435 SLR		S/L #14-#2	(4) 350 (1) 750	9⅜	
UH 750-635 SLR			(6) 350 (1) 750	13⅜	

Flood-Seal® multi-port connectors

Aluminum Flood-Seal twin-screw mechanical connectors – UH 1000 series



UH 1000-4 R



UH 1000-22 R



UH 1000-242 R

Twin screws double the reliability of ordinary set-screw connectors.

- Flood-Seal insulating rockets field tested in more than 10 million applications, and serve as waterproof spare outlet caps until used as waterproof cable insulators
- All connectors are 100% hi-pot tested at 4000 V for 60 seconds
- Prefilled with oxide inhibitor to prevent oxidation and keep out moisture
- Aluminum-alloy connector construction for high strength and high conductivity
- Dual-rated to accept a wide range of copper or aluminum conductors
- Exceed ANSI C119.1 and C119.4 requirements as well as Western Underground Committee Guidelines

Twin-screw one-way configuration

Cat. no.	Conductor range (AWG or kcmil)	Outlets	Length (in.)
UH 1000-2 R	#2-1000	2	4 ¹³ / ₁₆
UH 1000-4 R		4	9 ¹⁵ / ₁₆
UH 1000-6 R		6	15
UH 1000-8 R		8	20 ¹ / ₈

Note: For two-way configurations, please consult your ABB representative.

Twin-screw two-way configuration

Cat. no.	Conductor range (AWG or kcmil)	Outlets
UH 1000-22 R	#2-1000	4
UH 1000-33 R		6
UH 1000-44 R		8
UH 1000-55 R		10
UH 1000-66 R		12
UH 1000-88 R		16

UH 1000 series with 350 kcmil services

Cat. no.	Conductor range (AWG or kcmil)	Outlets
UH 1000-21 R	Feeder #2-1000,	3
UH 1000-222 R	Tap #6-350	6
UH 1000-242 R		8

Diagram

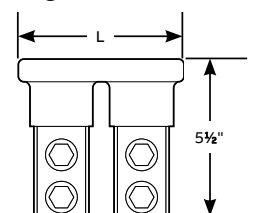

Flood-Seal® multi-port connectors

Aluminum Flood-Seal multi-port connectors – RAB series



RAB 1/0-21



RAB 1/0-3



RAB 6-C

High-performance, dual-rated connectors.

- Flood-Seal insulating rockets serve as waterproof spare outlet caps until used and are also resealable
- 6061-T6 aluminum connector construction provides high strength and high conductivity
- Dual-rated to accept a wide range of aluminum and copper conductors
- All connectors are 100% hi-pot tested at 4000 V for 60 seconds
- RAB 1/0 series offers compact design – great for street light applications
- RUS Accepted

RAB 1/0 series

Cat. no.	Conductor range (AWG or kcmil)	Outlets	Length (in.)
RAB 1/0-2	#14–1/0	2	1 ³ / ₄
RAB 1/0-3		3	2 ³⁹ / ₆₄
RAB 1/0-4		4	3 ⁷ / ₁₆
RAB 1/0-5		5	4 ⁹ / ₃₂
RAB 1/0-6		6	5 ¹ / ₈
RAB 1/0-7		7	5 ³¹ / ₃₂
RAB 1/0-8		8	6 ¹³ / ₁₆
RAB 1/0-9		9	7 ²¹ / ₃₂
RAB 1/0-10		10	8 ¹ / ₂
RAB 1/0-21		3	2 ³⁹ / ₆₄
RAB 1/0-22		4	3 ⁷ / ₁₆
RAB 1/0-31		4	3 ⁷ / ₁₆
RAB 1/0-32		5	4 ⁹ / ₃₂
RAB 1/0-33		6	5 ¹ / ₈
RAB 1/0-42		6	5 ¹ / ₈

Note: For oxide-inhibitor option, add “-C” suffix to the catalog number.

RAB 350 series

Cat. no.	Conductor range (AWG or kcmil)	Outlets	Length (in.)
RAB 2-C	#12 sol.–350	2	2 ⁷ / ₁₆
RAB 3-C		3	3 ⁵ / ₈
RAB 4-C		4	4 ¹³ / ₁₆
RAB 5-C		5	6
RAB 6-C		6	7 ¹ / ₈
RAB 8-C		8	9 ⁹ / ₁₆
RAB 10-C		10	11 ¹⁵ / ₁₆

Note: The RAB 350 series comes standard with inward-seal rockets. For outward-seal rockets, please consult your ABB representative. Provided with oxide inhibitor.

01 For EZ Torque® shear-head screws supplied in all outlets, add “-TS” suffix to the catalog number.



01

Flood-Seal® multi-port connectors

Aluminum Flood-Seal multi-port connectors – RAB and USB series



USB43S

Ideal for direct-burial, pedestal or vault installations.

- Field-adaptable cable sleeves enable installation on a wide range of conductor sizes
- Standard aluminum set screws with 5/16" socket hex spread compressive forces over conductor strands, reduce strand damage, result in lower contact resistance and provide high set-screw torque retention
- Compact design enables installation in limited spaces
- Dual-rated to accept a wide range of aluminum and copper conductors
- All connectors are 100% hi-pot tested at 4000 V for 60 seconds

- Built tough for rugged conditions – tough enough to withstand rough handling in the field, have an excellent dielectric strength rating (>700 V/mil) and have excellent aging characteristics under continuous high operating temperatures (to 130 °C)
- All connectors have oxide inhibitor and silicone grease to keep out moisture and make installation easy and convenient
- Comply with ANSI C119.1 and C119.4 as well as Western Underground C.G. 2.5
- RAB series is RUS Accepted

RAB 500 series

Cat. no.	Ports	Cable range (AWG or kcmil)	Length	
			in.	mm
RAB 35-C	3	#12–500	4.5	114
RAB 45-C	4		6.0	152
RAB 55-C	5		7.5	191
RAB 65-C	6		9.0	229
RAB 85-C	8		12.0	305

Note: Provided with oxide inhibitor.

USB 350 series

Cat. no.	Ports	Cable range (AWG or kcmil)	Length	
			in.	mm
USB33S	3	#12–350	3.6	91
USB43S	4		4.7	121
USB53S	5		5.9	150
USB63S	6		7.1	179
USB83S	8		9.4	238

Note: Provided with oxide inhibitor.

Diagrams

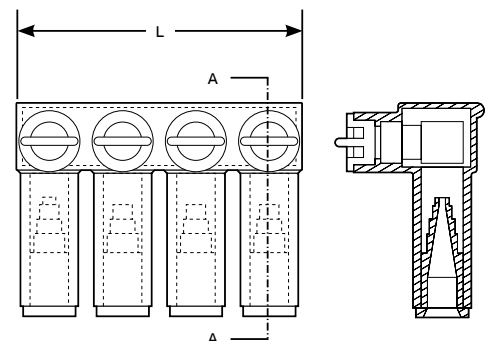

01 For EZ Torque® shear-head screws supplied in all outlets, add "-TS" suffix to the catalog number.



Flood-Seal® multi-port connectors

Aluminum Flood-Seal multi-port connectors – RXL series



RXL 4-C



RXL 600-6-C



RXL 600-31-C

Universal use! Install in direct-burial, handhole, pedestal or vault applications.

- Wide port spacing makes installation easier
- Field-adaptable cable sleeves enable installation on a wide range of conductor sizes
- Bars constructed of 6061-T6 aluminum alloy for high strength and high conductivity
- Standard aluminum set screws with 5/16" socket hex spread compressive forces over conductor strands, reduce strand damage, result in lower contact resistance and provide high set-screw torque retention
- All connectors are 100% hi-pot tested at 4000 V for 60 seconds
- Comply with ANSI C119.1 and C119.4 and Western Underground C.G. 2.5 and are RUS Accepted
- Dual-rated to accept a wide range of aluminum and copper conductors

RXL 350 series

Cat. no.	Outlets	Cable range (AWG or kcmil)	Length	
			in.	mm
RXL 3-C	3	#12-350	4.3	109
RXL 4-C	4		5.8	147
RXL 5-C	5		7.3	185
RXL 6-C	6		8.8	223
RXL 8-C	8		11.8	299

Note: Provided with oxide inhibitor.

01 For EZ Torque® shear-head screws supplied in all outlets, add “-TS” suffix to the catalog number.



01

RXL 600 Series

Cat. no.	Outlets	Cable range (AWG or kcmil)
RXL 600-3-C	3	#6-600
RXL 600-4-C	4	
RXL 600-5-C	5	
RXL 600-6-C	6	
RXL 600-31-C	4	
RXL 600-22-C	4	
RXL 600-33-C	6	
RXL 600-42-C	6	

Note: Provided with oxide inhibitor.

Diagrams

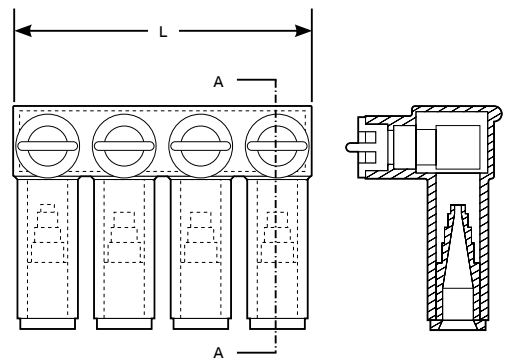

Flood-Seal® multi-port connectors

Aluminum Flood-Seal multi-port connectors – RXM series



RXM 4



RXM 22



RXM 31

The fully insulated and watertight connectors for direct-burial, handhole, pedestal and overhead applications.

- Flood-Seal EPDM insulating rockets field tested in more than 10 million applications
- 6061-T6 aluminum connector construction provides high strength and high conductivity
- Dual-rated to accept a wide range of copper or aluminum conductors, from #2 AWG solid to 1000 kcmil
- Ball-bottom screws support the widest conductor range and aid in breaking up aluminum oxides
- EPDM rubber cap is easy to find, prevents accidental removal and can be easily removed with pliers
- All connectors are 100% hi-pot tested at 4000 V for 60 seconds

Cable entry one side only

Cat. no.	Outlets	Length (in.)
RXM 2	2	3 ¹ / ₆
RXM 4	4	7 ¹ / ₄
RXM 6	6	10 ⁷ / ₈
RXM 8	8	14 ¹ / ₂
RXM 10	10	18 ⁵ / ₈
RXM 12	12	21 ³ / ₄

Cable entry from either side

Cat. no.	Outlets	Length (in.)
RXM 22	4	7 ¹ / ₄
RXM 33	6	10 ⁷ / ₈
RXM 44	8	14 ¹ / ₂
RXM 66	12	21 ³ / ₄

Example: RXM 22 accommodates a maximum of four cables, accessible from either side.

Custom orders

Cat. no.	Outlets	Length (in.)
RXM 31	4	7 ¹ / ₄
RXM 42	6	10 ⁷ / ₈

Order using first number for outlets needed on one side and second number for outlets needed on opposite side. For example, RXM 31 has three outlets on one side and one outlet on the other side.

For configurations up to a total of 12 outlets, please consult your ABB representative. Note: For oxide-inhibitor option, add "-C" suffix to the catalog number.

Diagrams

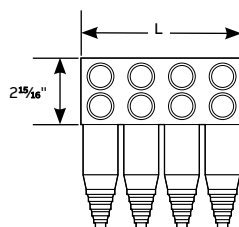

Cables enter from one side only

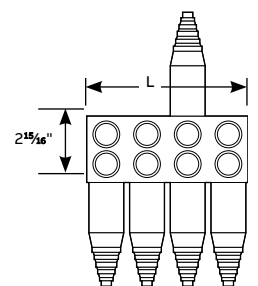
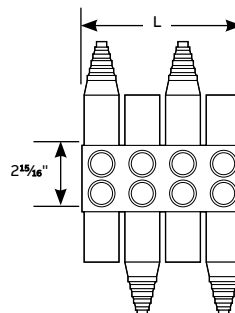

Flood-Seal® multi-port connectors

Aluminum Flood-Seal 95 series connectors



FS 95-6

Suitable for direct burial or installation in an enclosure.

- Compact, single-hole design ideal for residential applications
- Dual-rated for use with aluminum or copper lugs from #12 AWG to 350 kcmil
- All outlets and lugs (see kits below) approved for full cable rating – safe and reliable
- All connectors are 100% hi-pot tested at 4000 V for 60 seconds
- RUS Accepted

95 series connectors

Cat. no.	Outlets	Length (in.)
FS 95-2	2	2 ³ / ₄
FS 95-3	3	4 ¹ / ₄
FS 95-4	4	5 ³ / ₄
FS 95-5	5	7 ¹ / ₄
FS 95-6	6	8 ³ / ₄
FS 95-7	7	10 ¹ / ₄
FS 95-8	8	11 ³ / ₄
FS 95-9	9	13 ¹ / ₄
FS 95-10	10	14 ³ / ₄

Diagram

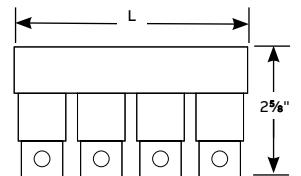

Flood-Seal® multi-port connectors

Flood-Seal 95 series terminal kits



CFB 350 CS

Kits have insulating outlet sleeve or heat-shrink sleeve and lug.

- Three die sets install the complete range of lugs, from #8 AWG to 350 kcmil
- Lugs prefilled with oxide-inhibiting compound and capped to prevent oxidation and keep out moisture

95 series terminal kits

Force-fit kit Cat. no.	Heat-shrink kit Cat. no.	Cable size (AWG or kcmil)					Die reference
		Concentric	Compressed	Compact	Solid		
CFG 8 CS	CFG 8 HS	#8	–	–	#6	5/8, BG, 687, 243, TU, 52, 8A	
CFG 6 CS	CFG 6 HS	#6	#6	#6	–		
CFG 4 CS	CFG 4 HS	#4	#4	#4	–		
CFG 2 CS	CFG 2 HS	#2	#2	#2 & #1	#1		
CFG 1 CS	CFG 1 HS	#1	#1	1/0	1/0		
CFG 1/0 CS	CFG 1/0 HS	1/0	1/0	2/0	2/0		
CFK 1/0 CS	CFK 1/0 HS	1/0	1/0	2/0	2/0	840, 324, 249, 658, TX, 76, 11A	
CFK 2/0 CS	CFK 2/0 HS	2/0	2/0	3/0	3/0		
CFK 3/0 CS	CFK 3/0 HS	3/0	3/0	4/0	4/0		
CFK 4/0 CS	CFK 4/0 HS	4/0	4/0	250	–		
CFK 250 CS	CFK 250 HS	250	250	300	–		
CFB 250 CS	CFB 250 HS	250	250	300	–	1 1/8-1, 299–655, 96, 13A, 321, 326	
CFB 300 CS	CFB 300 HS	300	300	350	–		
CFB 350 CS	CFB 350 HS	336.4–350	350	350	–		

Note: For a hex-headed bolt, add “-H” suffix to the catalog number.

Force-fit kit includes (1) dual-rated aluminum center-formed lug, (1) 3/8" Allen head mounting bolt, (1) Belleville washer and (1) insulating Flood-Seal rocket.

Heat-shrink kit includes (1) dual-rated aluminum center-formed lug, (1) 3/8" Allen head mounting bolt, (1) Belleville washer and (1) heat-shrink tubing.

Flood-Seal® multi-port connectors

Aluminum Flood-Seal 125 series connectors



FSN 6-125



FS 22-48



FSN 22



FS 3-125

Choose one-way configuration or two-way configuration.

- Dual-rated for use with aluminum or copper lugs from #12 AWG to 500 kcmil
- Designed for maximum contact to ensure cooler operation and more reliable joints
- Outlets equipped with ½" hex-head bolts with captive Belleville washers to accept standard one- or two-hole NEMA aluminum or copper lugs
- All connectors are 100% hi-pot tested at 4000 V for 60 seconds
- All outlets approved for full cable rating – safe and reliable
- All Flood-Seal connectors comply with ANSI C119.4
- RUS Accepted

One-way configuration

One-bolt design Cat. no.	Two-bolt design Cat. no.	Outlets	L (in.)
FS 2-125	FSN 2-125	2	3½
FS 3-125	FSN 3-125	3	5⅞
FS 4-125	FSN 4-125	4	7¼
FS 5-125	FSN 5-125	5	9⅞
FS 6-125	FSN 6-125	6	11
FS 7-125	FSN 7-125	7	12⅞
FS 8-125	FSN 8-125	8	14¾
FS 9-125	FSN 9-125	9	16⅝
FS 10-125	FSN 10-125	10	18½

Two-way configuration

One-bolt design Cat. no.	Two-bolt design Cat. no.	Outlets	L (in.)
FS 11-48	FSN 11	2	1½
FS 22-48	FSN 22	4	3⅞
FS 33-48	FSN 33	6	5¼
FS 44-48	FSN 44	8	7⅞
FS 55-48	FSN 55	10	8⅞
FS 66-48	FSN 66	12	10¾
FS 77-48	FSN 77	14	12⅝
FS 88-48	FSN 88	16	14½
FS 99-48	FSN 99	18	16⅞

Note: To order FSN series with Flood-Seal rockets included, add "-AWR" to catalog number. To order rockets separately, order catalog number CSN 2011 (one rocket per tower required).

Diagram

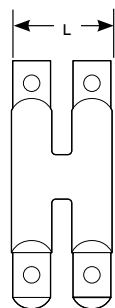

FSN 22

Flood-Seal® multi-port connectors

Aluminum Flood-Seal 125 series connectors – One- and two-hole type



One-way connectors with rubber insulation or two-way connectors with PVC insulation for #8 AWG to 500 kcmil cable.

- Designed for maximum contact to ensure cooler operation and more reliable joints
- Outlets equipped with ½" hex-head bolts with captive Belleville washers to accept standard one- or two-hole NEMA aluminum or copper lugs
- One- and two-way insulated connectors for #8 AWG to 500 kcmil cable
- All connectors are 100% hi-pot tested at 4000 V for 60 seconds
- All Flood-Seal connectors meet or exceed ANSI C119.4
- RUS Accepted

EPDM-insulated, one-way configuration

Cat. no.	Outlets	Length (in.)
FS 21-125	3	5 ³ / ₈
FS 111-125	3	5 ³ / ₈
FS 414-125	9	16 ⁵ / ₈
FS 31-125	4	7 ¹ / ₄
FS 212-125	5	9 ¹ / ₈
FS 222-125	6	11
FS 41-125	5	9 ¹ / ₈
FS 313-125	7	12 ⁷ / ₈
FS 323-125	8	14 ³ / ₄

Note: To order insulating sleeves for EPDM one-way connectors, see page 49.

PVC-insulated, two-way configuration

Cat. no.	Outlets
FST 125	3
FSTT 125	5
FSX 125	4
FSXX 125	6
FSY 125-21	3
FSY 125-42	6
FSY 125-64	10

Diagrams

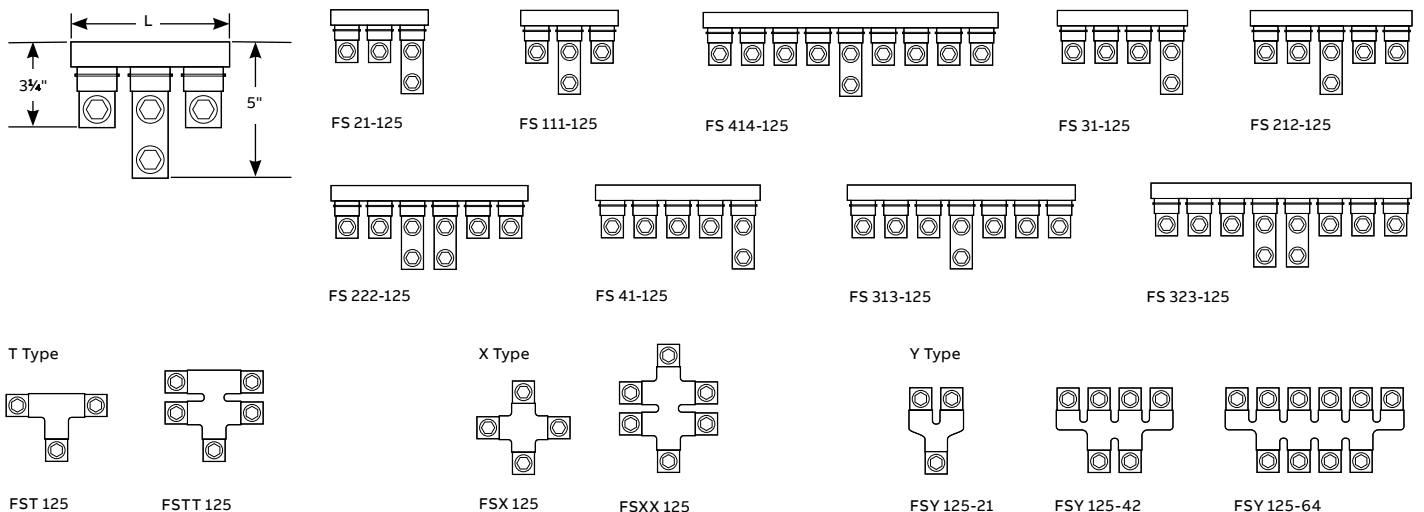

Flood-Seal® multi-port connectors

Flood-Seal bus connectors



Flood-Seal bus connectors

Cat. no.	No. of ports	2-Bolt large term.	1-Bolt small term.	Dimensions in. (mm)	
				Length	Height with sleeve
UPC 20	2	0	2	3.3 (84)	6.5 (165)
UPC 22	2	2	0	3.8 (97)	8.8 (222)
UPC 30	3	0	3	5.2 (132)	6.5 (165)
UPC 31	3	1	2	5.3 (135)	8.8 (222)
UPC 33*	3	3	0	5.9 (151)	8.8 (222)
UPC 40	4	0	4	7.1 (179)	6.5 (165)
UPC 41	4	1	3	7.3 (186)	8.8 (222)
UPC 42	4	2	2	7.6 (192)	8.8 (222)
UPC 44*	4	4	0	8.1 (205)	8.8 (222)
UPC 50	5	0	5	8.9 (227)	6.5 (165)

* For street light adapter option on the same side, add "-SL-1" suffix to catalog number.
 For street light adapter option on the opposite side, add "-SL" suffix to catalog number.
 Note: Maximum size conductor – single bolt: 350 kcmil; double bolt: 500 kcmil.
 For compression lugs, see the Blackburn® compression connectors catalog.

Get the port and terminal options you need for pedestal, vault, handhole or direct-burial applications.

- Flood-Seal EPDM sleeves feature waterproof O-ring sealing system
- Type WS sleeve seals single-bolt terminals and Type WL sleeve seals two-bolt terminals
- Indent on terminals mates with boss on compression lugs to prevent lugs from rotating
- All connectors are 100% hi-pot tested at 4000 V for 60 seconds

Cat. no.	No. of ports	2-Bolt large term.	1-Bolt small term.	Dimensions in. (mm)	
				Length	Height with sleeve
UPC 51	5	1	4	9.2 (233)	8.8 (222)
UPC 52	5	2	3	9.4 (240)	8.8 (222)
UPC 55*	5	5	0	10.2 (259)	8.8 (222)
UPC 60	6	0	6	10.8 (248)	6.5 (165)
UPC 61	6	1	5	11.1 (281)	8.8 (222)
UPC 62	6	2	4	11.3 (287)	8.8 (222)
UPC 66*	6	6	0	12.3 (312)	8.8 (222)
UPC 80	8	0	8	14.6 (370)	6.5 (165)
UPC 81	8	1	7	14.8 (376)	8.8 (222)
UPC 88*	8	8	0	16.6 (421)	8.8 (222)

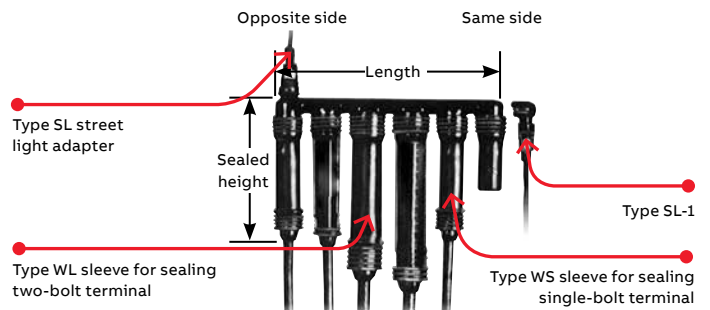

Diagrams

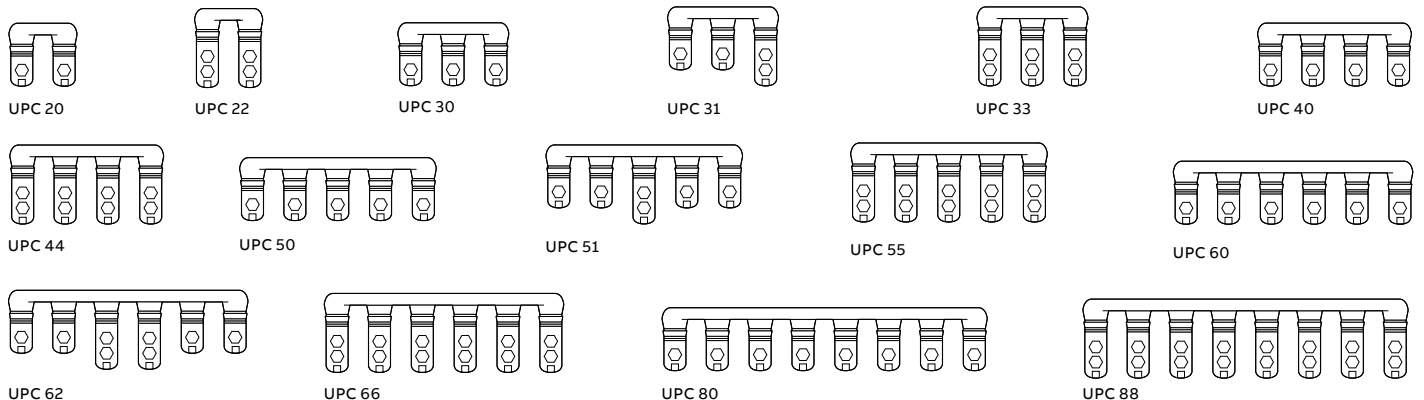

Flood-Seal® multi-port connectors

Connectors, adapter and sleeves

Submersible street light connectors



USL 11

Great for pedestal, vault, light pole base or direct-burial jobs.

- Rated for 600 V, 100 A – built for heavy-duty loads; helps bring power to nearly all types of street lights
- All connectors are 100% hi-pot tested at 4000 V for 60 seconds
- Dual-rated and approved for #12 AWG solid through #4 AWG stranded aluminum or copper connections

Submersible street light connectors

Cat. no.	Ports	Width (in.)	Height w/ sleeve (in.)	Screw type
USL 11	2	–	6.3	Slotted
USL 30	3	3.6	3.1	Slotted
USL 11 H	2	–	5.3	Hex-socket
USL 30 H	3	3.6	3.1	Hex-socket

Note: For contour-plated set-screw option that does not damage the conductor when tightened down, add “-H” suffix to the catalog number.

Street light adapter



Connect your small conductors to a Squid® bus junction.

- 356-T6 aluminum connector construction provides high strength and conductivity
- Dual-rated for small conductors – connect #10 AWG solid through #4 AWG stranded cables to a standard Squid® bus junction

Street light adapter

Cat. no.	Description
SLA 1	Street light adapter

Squid® sealing sleeves



Make seals without tape, compound or heat source.

- EPDM rubber sealing sleeve grips the conductor insulation on one end and seals onto the insulated bus on the other end
- Sleeves provided with plug installed – can be used as terminal covers
- SC adapter available – perfect to use when #2 AWG compact standard 600 V underground service entrance cable has an insulation outer diameter less than 0.390"

Squid® sealing sleeves

Cat. no.	For use on	Sealing range (cond. O.D. over insulation)	Length (in.)
WS 2 P	Single-bolt UPC, SCU	0.4–0.9	6 ¹ / ₁₆
WL 2 P	Two-bolt UPC, UPB, SCU	0.4–0.9	8 ⁵ / ₁₆
WL 3 P	UPC, UPB, SCU	0.5–1.2	8 ⁵ / ₁₆
WB 20 P	UB	0.4–0.9	5 ³ / ₈
SC	Small conductor adapter for WS, WL 2 and WB sleeves	0.2–0.4	–
WHB 3 P	UBC bus (large terminal)	0.5–1.3	7 ³ / ₈
SPL 6	Squid type WL sleeves, for #6 AWG stranded through 4/0 AWG connections	0.6–0.7	–

Flood-Seal® multi-port connectors

Aluminum Flood-Seal 175 series connectors

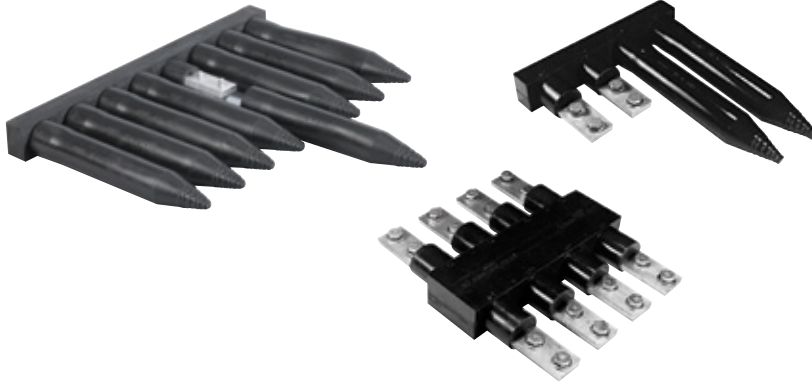

High-conductivity aluminum connectors.

- Robust design ideal for network and underground applications
- Connector made of extruded high-conductivity aluminum
- Precision-molded EPDM rubber insulation
- All connectors are 100% hi-pot tested at 4000 V for 60 seconds
- Accommodates select cable limiters
- Hardware included – ready for use

One-way configuration

Diagram	Cat. no.	Outlets	L (in.)
	FS 175-2	2	6
	FS 175-3	3	9
	FS 175-4	4	12
	FS 175-5	5	15
	FS 175-6	6	18
	FS 175-7	7	21
	FS 175-8	8	24

Two-way configuration

Diagram	Cat. no.	Outlets	L (in.)
	FS 22-175	4	6
	FS 33-175	6	9
	FS 44-175	8	12
	FS 55-175	10	15
	FS 66-175	12	18
	FS 88-175	16	24
	FS 1010-175	20	27
	FS 1212-175	24	30

Note: For special applications or a greater number of outlets, please consult your ABB representative. To order FS175 series with Flood-Seal rockets included, add "-AWR" to catalog number. To order rockets separately, order catalog number FS1175 or FS1175L (one rocket per tower required).

Accessories – sold separately

01 FS 1175 Flood-Seal EPDM rubber insulating sleeve covers the entire conductor range. Use the Flood-Seal 175 dual adapter kit (page 52) for two conductors per outlet.



01



02

02 AL-NTN series aluminum lugs, 1/0 AWG to 2000 kcmil. See the Blackburn® compression connectors catalog.

Flood-Seal® multi-port connectors

Copper Flood-Seal 175 series connectors



High-conductivity copper connectors.

- Robust design ideal for network and underground applications
- Precision molded EPDM rubber insulation
- All connectors are 100% hi-pot tested at 4000 V for 60 seconds
- Accommodates select cable limiters
- Hardware included – ready for use

One-way configuration

Diagram	Cat. no.	Outlets	L (in.)
	FS 175-2 CU	2	6
	FS 175-3 CU	3	9
	FS 175-4 CU	4	12
	FS 175-5 CU	5	15
	FS 175-6 CU	6	18
	FS 175-7 CU	7	21
	FS 175-8 CU	8	24

Two-way configuration

Diagram	Cat. no.	Outlets	L (in.)
	FS 22-175 CU	4	6
	FS 33-175 CU	6	9
	FS 44-175 CU	8	12
	FS 55-175 CU	10	15
	FS 66-175 CU	12	18
	FS 88-175 CU	16	24
	FS 1010-175 CU	20	27
	FS 1212-175 CU	24	30

Note: For special applications or a greater number of outlets, please consult your ABB representative. To order FS175 series with Flood-Seal rockets included, add "-AWR" to catalog number. To order rockets separately, order catalog number FS1175 or FS1175L (one rocket per tower required).

Accessories – sold separately

01 FS 1175 Flood-Seal EPDM rubber insulating sleeve covers the entire conductor range. Use the Flood-Seal 175 dual adapter kit (see following page) for two conductors per outlet.



01

Flood-Seal® multi-port connectors

Flood-Seal 175 series bus connectors

01 FS 1175 Flood-Seal EPDM rubber insulating sleeve covers the entire conductor range. Order separately – please consult your ABB representative.

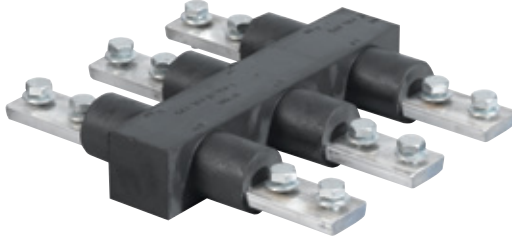

FXL 175 aluminum series – For two-hole NEMA lugs up to 1000 kcmil

Cat. no.	Outlets
FXL 22-175	4
FXL 33-175	6
FXL 44-175	8
FXL 66-175	12

Rubber insulation ensures a watertight connection.

- Outlets equipped with ½-13 UNC and accept hex-head screws with captive Belleville washers to accept two-hole NEMA aluminum or copper compression lugs
- All connectors are 100% hi-pot tested at 4000 V for 60 seconds

FXL 175 copper series – For two-hole NEMA lugs up to 1000 kcmil

Cat. no.	Outlets
FXL 22-175 CU	4
FXL 33-175 CU	6
FXL 44-175 CU	8
FXL 66-175 CU	12



01

Diagram

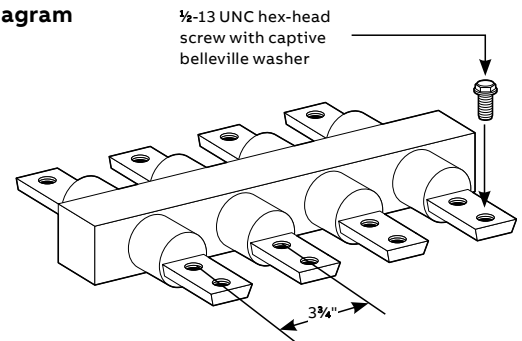

Flood-Seal 175 dual adapter kit



Flood-Seal 175 dual adapter kit

Cat. no.	Description
FS 175 DPK	175 dual adapter kit

Note: Connector not included.

Adapter kit enables installer to pull two connections off one leg.

- Double cable capacity (500 kcmil max.)
- Rugged kit includes twin tower rocket, adapter ring and aluminum hardware

Diagram

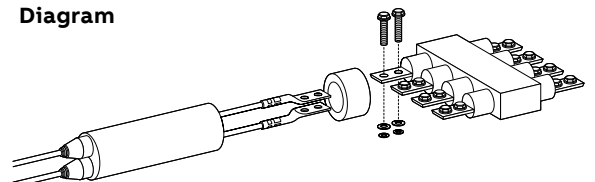

Pedestal connectors and covers

Aluminum lay-in pedestal connectors

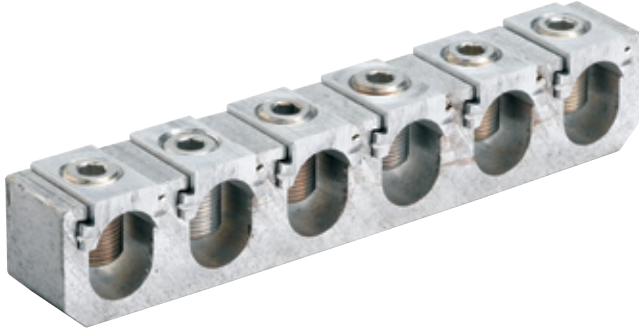

Effortlessly install or remove large, stiff cables in confined areas.

- Cables are easily placed into the keeper slot
- Minimizes the hassle and hazards of having to force cables into the closed cable ports found on conventional mechanical connectors
- Saves time and labor
- Requires only a cable stripper and Allen hex wrench – no crimping tools or dies or other special tools are needed for installation
- Dual-rated for use with aluminum or copper cable
- Ball-bottom screws ensure even force distribution in the cable/connector interface

ABCK series

Cat. no.	Conductor range (AWG or kcmil)	Outlets
ABCK 6350	#6-350	6
ABCK 6600	#2-600	
ABCK 6600 DS*	#2-600	

* "-DS" suffix indicates double set screws.

Diagrams

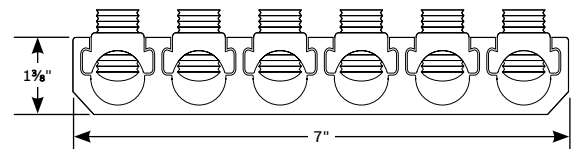

ABCK 6350

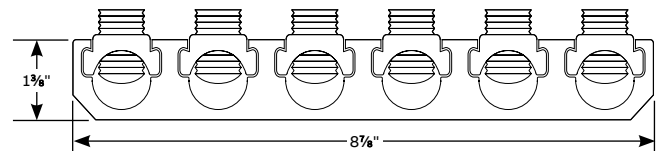

ABCK 6600

Pedestal connectors and covers

Aluminum set-screw bar pedestal connectors – Single-line bar



ABC 4350

Available with up to eight outlets for aluminum or copper conductors.

- Dual-rated to accept aluminum or copper conductors
- Ball-bottom screws ensure maximum conductor contact pressure and break up interstrand oxides
- Meets or exceeds ANSI C119.4 specifications

Single-line bar

Cat. no.	Outlets	Length (in.)	Boot number	Cable range (AWG or kcmil)
ABC 240	2	1 ¹ / ₁₆	BB 10	#6–250
ABC 340	3	2 ⁹ / ₁₆	BB 10	
ABC 440	4	3 ⁷ / ₁₆	BB 10	
ABC 540	5	4 ⁵ / ₁₆	BB 11	
ABC 640	6	5 ³ / ₁₆	BB 11	
ABC 740	7	6 ¹ / ₁₆	BB 12	
ABC 840	8	6 ¹⁵ / ₁₆	BB 12	
ABC 2350	2	2	BB 10	#12–350
ABC 3350	3	3	BB 10	
ABC 4350	4	4	BB 10	
ABC 5350	5	5	BB 11	
ABC 6350	6	6	BB 11	
ABC 7350	7	7	BB 12	
ABC 8350	8	8	BB 12	

Note: For oxide-inhibitor option, add “-C” suffix to the catalog number.
For street light-outlet option, add “-SL” suffix to the catalog number.
For insulating covers, see page 59.
For special applications, please consult your ABB representative.

Cat. no.	Outlets	Length (in.)	Boot number	Cable range (AWG or kcmil)
ABC 2500	2	2 ¹ / ₁₆	BB 10	#6–500
ABC 3500	3	3 ¹ / ₁₆	BB 10	
ABC 4500	4	4 ¹ / ₁₆	BB 11	
ABC 5500	5	5 ¹ / ₁₆	BB 11	
ABC 6500	6	6 ¹ / ₁₆	BB 12	
ABC 7500	7	7 ¹ / ₁₆	BB 14	
ABC 8500	8	8 ¹ / ₁₆	BB 14	
ABC 2750	2	2 ³ / ₄	BB 10	1/0–750
ABC 3750	3	4 ³ / ₁₆	BB 13	
ABC 4750	4	5 ⁹ / ₁₆	BB 13	
ABC 5750	5	7	BB 12	
ABC 6750	6	8 ³ / ₈	BB 14	
ABC 7750	7	9 ¹³ / ₁₆	BB 15	
ABC 8750	8	11 ³ / ₁₆	BB 15	

01 For EZ Torque® shear-head screws supplied in all outlets, add “-TS” suffix to the catalog number.



01

Diagram

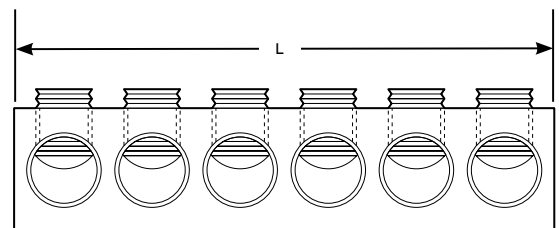

Pedestal connectors and covers

Aluminum set-screw bar pedestal connectors – Double-row bar



High-strength aluminum alloy maintains constant bolting pressure on conductors.

- Dual-rated to accept aluminum or copper conductors
- Ball-bottom screws ensure maximum conductor contact pressure and break up interstrand oxides
- Meets or exceeds ANSI C119.4 specifications

Double-row bar

Cat. no.	Outlets	Length (in.)	Width (in.)	Boot no.	Cable range (AWG or kcmil)
ABC 40-22	4	1 ⁵ / ₈	2	BB 17	#6-250
ABC 40-33	6	2 ⁷ / ₁₆	2	BB 17	#6-250
ABC 40-44	8	3 ³ / ₁₆	2	FB 33*	#6-250
ABC 350-22	4	2 ¹ / ₈	2 ¹ / ₂	BB 17	#12-350
ABC 350-33	6	3	2 ¹ / ₂	FB 33*	#12-350
ABC 350-44	8	3 ¹⁵ / ₁₆	2 ³ / ₈	FB 33*	#12-350
ABC 500-22	4	2 ¹ / ₁₆	2 ³ / ₄	FB 33*	#6-500
ABC 500-33	6	3 ¹ / ₁₆	2 ³ / ₄	FB 33*	#6-500
ABC 500-44	8	4 ¹ / ₁₆	2 ³ / ₄	-**	#6-500
ABC 750-22	4	2 ³ / ₄	3 ¹ / ₄	-**	1/0-750
ABC 750-33	6	4 ³ / ₁₆	3 ¹ / ₄	-**	1/0-750
ABC 750-44	8	5 ⁹ / ₁₆	3 ¹ / ₄	-**	1/0-750

* EPDM Flexi-Boot, see page 59.

** For other insulating covers, please consult your ABB representative.

Note: For oxide-inhibitor option, add "-C" suffix to the catalog number.

For street light-outlet option, add "-SL" suffix to the catalog number.

For special applications, please consult your ABB representative.

Diagram

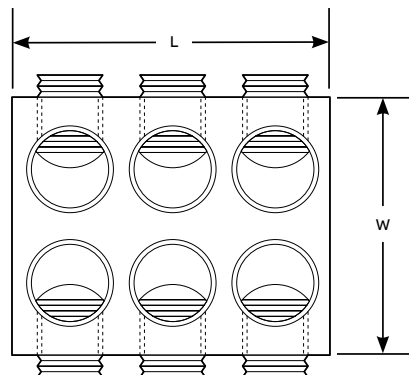

Pedestal connectors and covers

Aluminum pedestal connectors



ZVB 5053

Insulated and uninsulated pedestal connectors with up to 10 outlets.

- Compact Zeebar® design doubles cable capacity and reduces footprint
- ZVB series features clear PVC encapsulation to enable safe installations and disconnects – and provide insulation
- Easy to install – all screws are on top, and a $\frac{5}{16}$ " hex wrench is all you need
- Dual-rated to accept aluminum or copper conductors
- Ball-bottom screws ensure maximum conductor contact pressure and break up interstrand oxides
- Meets or exceeds ANSI C119.4 specifications

Insulated and uninsulated pedestal connectors

Insulated Cat. no.	Uninsulated Cat. no.	Outlets	L (in.)	Cable range (AWG or kcmil)
ZVB 2023	ZBC 2023	4	2 $\frac{1}{4}$	#12–350
ZVB 3033	ZBC 3033	6	3 $\frac{1}{4}$	#12–350
ZVB 4043	ZBC 4043	8	4 $\frac{1}{4}$	#12–350
ZVB 5053	ZBC 5053	10	5 $\frac{1}{4}$	#12–350
ZVB 2025	ZBC 2025	4	2 $\frac{7}{16}$	#6–500
ZVB 3035	ZBC 3035	6	3 $\frac{9}{16}$	#6–500
ZVB 4045	ZBC 4045	8	4 $\frac{11}{16}$	#6–500
ZVB 5055	ZBC 5055	10	5 $\frac{13}{16}$	#6–500

Note: For oxide-inhibitor option, add "-C" suffix to the catalog number.

For a kit containing one uninsulated and two insulated connectors, add "-K" suffix to the catalog number.

Diagram

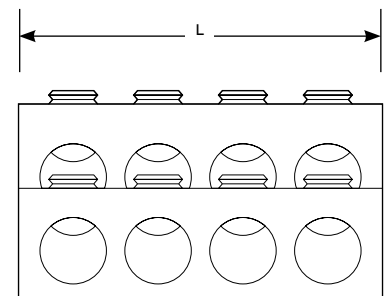

Pedestal connectors and covers

Insulated pedestal connector bars — Type PSB-C



Port-separated clear plastic cover provides insulation against accidental contact during installation.

- Bars are constructed of 6061-T6 aluminum alloy for strength and conductivity
- Standard aluminum set screws with 5/16" socket hex spread compressive forces over conductor strands, reduce strand damage, increase interstrand movement, result in lower contact resistance and provide high set-screw torque retention
- Dual-rated for use with aluminum or copper conductors
- Contax® oxide inhibitor standard in all conductor ports
- Meets ANSI C119.4 specifications
- RUS Accepted

350 series – Insulated PSB bars dual rated (Al-Cu)

Cat. no.	No. of ports	Cable range (AWG or kcmil)	Length (in.)
PSB4359C	4	#12–350	4.34
PSB6359C	6		6.43
PSB8359C	8		8.53

500 series – Insulated PSB bars dual rated (Al-Cu)

Cat. no.	No. of ports	Cable range (AWG or kcmil)	Length (in.)
PSB4559C	4	#10–500	4.9
PSB6559C	6		7.28
PSB8559C	8		9.66

Note: For additional product options, contact your ABB representative.

Diagram

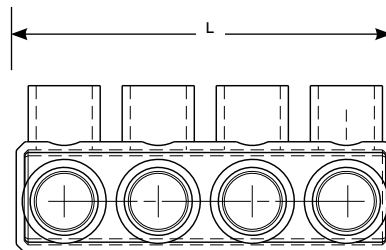

Pedestal connectors and covers

Insulated aluminum pedestal connectors



CLR 6350

See the connector through the transparent insulator.

- Integral cover helps retain set screws – no lost parts to worry about
- Fully insulated with clear lock-on PVC cover
- RUS Accepted

Insulated aluminum pedestal connectors

Cat. no.	Outlets	Wire range (AWG or kcmil)
CLR 340	3	#12–4/0
CLR 440	4	
CLR 540	5	
CLR 640	6	
CLR 3350	3	#12–350
CLR 4350	4	
CLR 5350	5	
CLR 6350	6	

Pedestal connectors and covers

Insulating covers for set-screw bar pedestal connectors

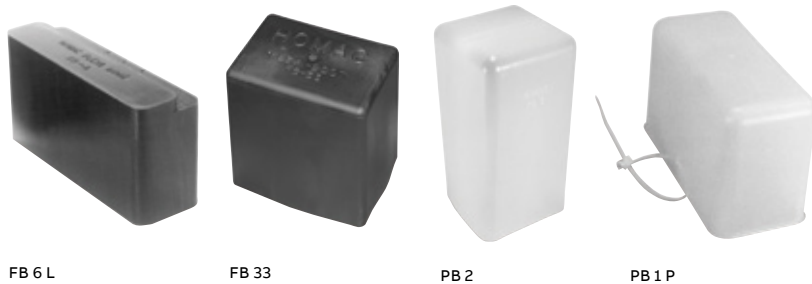

Rugged insulating covers to protect pedestal connectors.

- FB 33 and FB 6 L feature EPDM rubber flexi-boot and flexible locking ribs
- Boot will not crack from cold embrittlement and will not degrade or soften due to heat
- Locking ribs prevent accidental removal of EPDM cover

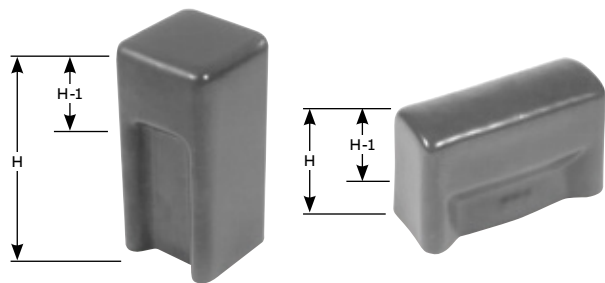

EPDM rubber FB series

Cat. no.	Height (in.)	Length (in.)	Width (in.)
FB 33	5 ¹ / ₄	4 ³ / ₄	3 ³ / ₈
FB 6 L	3 ¹ / ₂	7 ¹ / ₄	2 ¹ / ₁₆

PVC BB series

Cat. no.	Height (in.)	Height-1 (in.)	Length (in.)	Width (in.)
BB 10	3 ⁵ / ₁₆	1 ³ / ₈	4 ¹ / ₈	2 ¹ / ₈
BB 11	2 ⁷ / ₈	1 ³ / ₈	5 ⁷ / ₈	2 ¹ / ₈
BB 12	3 ³ / ₄	1 ⁷ / ₈	7 ³ / ₄	2 ¹ / ₄
BB 13	3 ³ / ₄	1 ⁷ / ₈	5 ¹⁵ / ₁₆	2 ³ / ₄
BB 14	3 ³ / ₄	1 ⁷ / ₈	8 ⁵ / ₈	2 ³ / ₄
BB 15	3 ³ / ₄	1 ⁷ / ₈	11 ¹¹ / ₁₆	2 ³ / ₄
BB 17	6 ⁷ / ₈	2 ¹ / ₈	3 ¹ / ₈	3 ¹ / ₁₆

Polyethylene PB series

Cat. no.	Height (in.)	Length (in.)	Width (in.)
PB 2	8	4	4 ³ / ₁₆
PB 1 P	4	6 ¹ / ₄	2 ⁷ / ₈

Note: For cover sizes not listed, please consult your ABB representative.
 All boots have a nominal wall thickness of 1/8".
 All sizes given for BB and PB series are inside dimensions.

Wildlife protectors



Protect wildlife and prevent interrupted service and lost revenue.

- Easy to install
- Reusable
- WL series are precision-molded in virgin PVC – contaminant-free, safe for contact with wildlife

Wildlife protectors

Cat. no.	Height (in.)	Width (in.)	Material
WL 3-12	12	3	Gray PVC
WL 3.5-16	16	3½	
WLP 10 T	12	2 ¹¹ / ₁₆	
WLP 10 T 18-1.5	21 ⁵ / ₈	2 ¹¹ / ₁₆	
WLP 11 S	11¼	3	
WLP-CSP	8¾	11 ³ / ₈	
WL 6137	21	16½	High-density black polyethylene
SQG 1212	14¾	14¾	

Diagrams

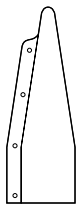

WL 3-12

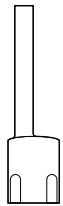

WLP 10 T



WLP 11 S

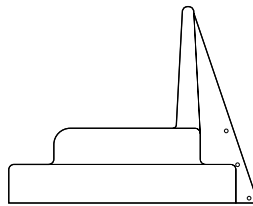

WLP-CSP

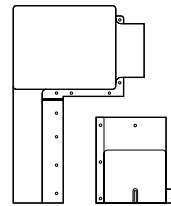

WL 6137

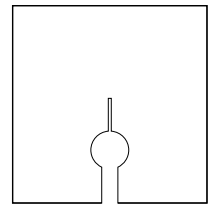

SQG 1212

Compression splice kits

Aluminum Flood-Seal® compression splice kits



RRK 500

Reliable underground watertight repair splice with locking EPDM cover.

- Radiating rib design dissipates heat, centers the watertight insulating cover and seals perfectly every time
- Rubber Flood-Seal insulating cover fits snugly for maximum heat dissipation, no tape required
- Compact size allows you to install connectors on up to 4/0 AWG cable in only 10" of space using UT 3 M or UT 3 tools
- Prefilled with oxide inhibitor to prevent oxidation and keep out moisture
- Exceeds ANSI C119.4 requirements and is RUS Accepted

Aluminum Flood-Seal compression splice kits

Cat. no.	Color code	Wire size (AWG or kcmil)		Connector length (in.)	Insulator length (in.)	Installing dies	Strip length (in.)
		From	To				
RRK 4	Orange	#4	#4	2	5½	½ (3)	1
RRK 2	Red	#2	#2	3	5½	⅝ (5)	1½
RRK 24	Red/Orange	#2	#4			⅝ (5)	
RRK 1	Red	#1	#1			⅝ (5)	
RRK 10	Yellow	1/0	1/0			⅝ (5)	
RRK 102	Yellow/Red	1/0	#2			⅝ (5)	
RRK 20	Gray	2/0	2/0			⅝ (5)	
RRK 201	Gray/Red	2/0	#1			⅝ (5)	
RRK 202	Gray/Red	2/0	#2			⅝ (5)	
RRK 2010	Gray/Yellow	2/0	1/0			⅝ (5)	
RRK 30	Black	3/0	3/0	4¼	7¼	⅝ (7)	2¼
RRK 3010	Black/Yellow	3/0	1/0			⅝ (5)	
RRK 3020	Black/Gray	3/0	2/0			⅝ (7)	
RRK 40	Pink	4/0	4/0			⅝ (7)	
RRK 4010	Pink/Yellow	4/0	1/0			⅝ (7)	
RRK 4020	Pink/Gray	4/0	2/0			⅝ (7)	
RRK 4030	Pink/Black	4/0	3/0			⅝ (7)	
RRK 40-840	Pink	4/0	4/0	4½	7½	840, 249, 11A	2½
RRK 250	None	250	250			840, 249, 11A	
RRK 300	None	300	300			840, TX, 76, 249, 11A	
RRK 350	None	350	350			840, TX, 76, 249, 11A	
RRK 350300	None	350	300			840, TX, 76, 249, 11A	
RRK 35040	None	350	4/0			840, TX, 76, 249, 11A	
RRK 500	None	500	500	6¾	10¾	472, 655, 13A, 96, 1½-2	2½

Diagrams

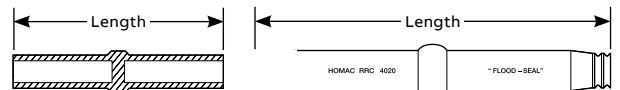

Note: For copper splice kits, add "CU" suffix to the catalog number.

Compression splice kits

Aluminum heat-shrink compression splice kits



RRK 40 HS

Heat-shrink tubing creates sealed, watertight splices.

- Radiating rib design dissipates heat, centers the watertight insulating cover and seals perfectly every time
- Heavy-wall heat-shrink tubing enables you to crimp the two pieces of wire together, then heat the splice with a hot-air gun to get a fully sealed, watertight repair splice
- Prefilled with oxide inhibitor to prevent oxidation and keep out moisture
- Exceeds ANSI C119.4 requirements and is RUS Accepted

Aluminum heat-shrink compression splice kits

Cat. No.	Color code	Wire size (AWG or kcmil)		Connector length (in.)	Insulator length (in.)	Installing dies	Strip length (in.)
		From	To				
RRK 4 HS	Orange	#4	#4	2	5½	½ (3)	1
RRK 2 HS	Red	#2	#2	3	5½	⅝ (5)	1½
RRK 24 HS	Red/Orange	#2	#4			⅝ (5)	
RRK 1 HS	Red	#1	#1			⅝ (5)	
RRK 10 HS	Yellow	1/0	1/0			⅝ (5)	
RRK 102 HS	Yellow/Red	1/0	#2			⅝ (5)	
RRK 20 HS	Gray	2/0	2/0			⅝ (5)	
RRK 201 HS	Gray/Red	2/0	#1			⅝ (5)	
RRK 202 HS	Gray/Red	2/0	#2			⅝ (5)	
RRK 2010 HS	Gray/Yellow	2/0	1/0			⅝ (5)	
RRK 30 HS	Black	3/0	3/0	4¼	7¼	⅝ (7)	2¼
RRK 3010 HS	Black/Yellow	3/0	1/0			⅝ (5)	
RRK 3020 HS	Black/Gray	3/0	2/0			⅝ (7)	
RRK 40 HS	Pink	4/0	4/0			⅝ (7)	
RRK 4010 HS	Pink/Yellow	4/0	1/0			⅝ (7)	
RRK 4020 HS	Pink/Gray	4/0	2/0			⅝ (7)	
RRK 4030 HS	Pink/Black	4/0	3/0			⅝ (7)	
RRK 40-840 HS	Pink	4/0	4/0	4¼	7¼	840, 249, 11A	2½
RRK 250 HS	None	250	250			840, 249, 11A	
RRK 300 HS	None	300	300			840, TX, 76, 249, 11A	
RRK 350 HS	None	350	350			840, TX, 76, 249, 11A	
RRK 350300 HS	None	350	300			840, TX, 76, 249, 11A	
RRK 35040 HS	None	350	4/0			840, TX, 76, 249, 11A	
RRK 500 HS	None	500	500	6¾	10¾	472, 655, 13A, 96, 1½-2	2¾

Note: Use the Homac UT 3 or UT 3 M tool for wire sizes up to 4/0 AWG.

Compression splice kits

Copper Flood-Seal® compression splice kits



Dissipate heat and make perfect watertight connections.

Homac copper Flood-Seal compression splice kits enable you to quickly make watertight copper-to-copper splice connections or repair copper service cables damaged by dig-ins or failures and restore their watertight integrity. The unique design of the splice/cover combination makes this the fastest and easiest watertight splicing solution available. The pre-greased insulating cover slides effortlessly onto the cable. After you've prepared the cable and crimped the splice, simply slide the cover back over the splice until it is positively centered and mates with the connector rib. That's it – no cutting, taping, heat guns or pull cords!

- Radiating rib dissipates heat, centers the watertight insulating cover and seals perfectly every time
- Single-piece Flood-Seal insulating covers are pre-lubricated and sized for the connection
- Easy installation saves you time and money
- Exceeds ANSI C119.1 requirements

Copper Flood-Seal compression splice kits

Cat. no.	Wire size (AWG or kcmil)	Connector length (in.)	Insulator length (in.)	Installing dies	Strip length (in.)
RRK 2 CU	#2	2	4 1/8	TQ, 42, 163, 1/2	1
RRK 10 CU	1/0	2 1/2	5 1/2	TU, 52, BG, 243, 5/8	1 1/8
RRK 20 CU	2/0	2 1/2	5 1/2	TU, 52, BG, 243, 5/8	1 1/8
RRK 30 CU	3/0	2 1/2	5 1/2	TU, 52, BG, 243, 5/8	1 1/8
RRK 40 CU	4/0	2 5/8	7 1/4	TW-TY, 54, 243	1 1/4
RRK 250 CU	250	2 5/8	7 1/2	840, 76, 249	1 1/4
RRK 350 CU	350	2 5/8	7 1/2	840, 76, 249	1 1/4
RRK 500 CU	500	3 3/4	9 1/2	96, 472, 655, 1 1/8-2	1 3/4

Diagrams

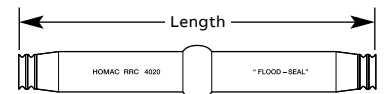
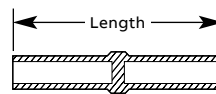

Compression splice kits

Aluminum Flood-Seal® compression splice kits



FSK 500

Dual-rated kits approved for a wide range of aluminum or copper connections.

- All kits include one submersible splice cover and one aluminum compression splice to ensure a fully insulated, watertight repair splice, no tape required
- Prefilled with oxide inhibitor and capped to prevent oxidation and keep out moisture.

Aluminum Flood-Seal compression splice kits

Cat. no.	Wire size (AWG or kcmil)		Splice cover
	From	To	
FSK 4	#4	#4	FSS 20
FSK 2	#2	#2	
FSK 1	#1	#1	
FSK 1/0	1/0	1/0	
FSK 1/0 R 2	1/0	#2	
FSK 2/0 R 1/0	2/0	1/0	
FSK 2/0	2/0	2/0	
FSK 4/0 R 2/0	4/0	2/0	FSS 350
FSK 3/0	3/0	3/0	
FSK 4/0	4/0	4/0	
FSK 250	250	250	
FSK 300	300	300	

Note: For kits with copper splices or with open-ended splice covers, please consult your ABB representative.

Cat. no.	Wire size (AWG or kcmil)		Splice cover
	From	To	
FSK 350 R 4/0	350	4/0	FSS 500
FSK 350	350	350	
FSK 400	400	400	
FSK 500 R 4/0	500	4/0	
FSK 500 R 350	500	350	
FSK 500	500	500	
FSK 600	600	600	
FSK 750	750	750	FSS 1000
FSK 750 R 500	750	500	
FSK 1000 R 500	1000	500	
FSK 1000 R 750	1000	750	
FSK 1000	1000	1000	

Compression splice kits

In-line compression splice kits



ULSK 500 HS



ULSK 4/0

Dual-rated kits include submersible splice cover.

- Heat-shrink kits include pre-sized heat-shrink tubing enabling you to crimp the two cables together, then heat the splice with a hot-air gun to get a fully sealed, watertight repair splice
- Flood-Seal® kits include one submersible splice cover that fits snugly for maximum heat dissipation and creates a fully insulated, watertight repair splice
- Dual-rated and approved for a wide range of aluminum or copper connections
- Prefilled with oxide inhibitor and capped to prevent oxidation and keep out moisture

Heat-shrink ULSK-HS series, pre-sized heat-shrink tubing included



Cat. no.	Conductor size (AWG or kcmil)
ULSK 6 HS	#6
ULSK 4 HS	#4
ULSK 2 HS	#2
ULSK 1 HS	#1
ULSK 1/0 HS	1/0
ULSK 2/0 HS	2/0
ULSK 3/0 HS	3/0
ULSK 4/0 HS	4/0
ULSK 250 HS	250
ULSK 300 HS	300
ULSK 350 HS	350
ULSK 400 HS	400
ULSK 500 HS	500
ULSK 600 HS	600
ULSK 750 HS	750
ULSK 800 HS	800
ULSK 1000 HS	1000

Note: For reducing kits, please contact your ABB representative.

Flood-Seal ULSK series

Cat. no.	Conductor size (AWG or kcmil)	Splice cover
ULSK 8	#8	FSS 20
ULSK 6	#6	
ULSK 4	#4	
ULSK 2	#2	
ULSK 1	#1	
ULSK 1/0	1/0	
ULSK 2/0	2/0	FSS 350
ULSK 3/0	3/0	
ULSK 4/0	4/0	
ULSK 250	250	
ULSK 300	300	FSS 500L
ULSK 350	350	
ULSK 400	400	
ULSK 500	500	
ULSK 600	600	FSS 1000
ULSK 750	750	
ULSK 800	800	
ULSK 1000	1000	

Compression splice kits

Copper in-line compression splice kits



Make copper splices using kits with either a rubber insulating cover or heat-shrink tubing.

- Flood-Seal® kits include a rubber insulating cover that fits snugly for maximum heat dissipation
- Heat-shrink kits include pre-sized heat-shrink tubing, enabling you to crimp the two pieces of wire together, then heat the splice with a hot-air gun to get a fully sealed, watertight repair splice
- Connectors have a center cable stop to ensure equal cable insertion

Heat-shrink ULCK-HS series, pre-sized heat-shrink tubing included



Cat. no.	Conductor size (AWG or kcmil)
ULCK 8 HS	#8
ULCK 6 HS	#6
ULCK 4 HS	#4
ULCK 2 HS	#2
ULCK 1 HS	#1
ULCK 1/0 HS	1/0
ULCK 2/0 HS	2/0
ULCK 3/0 HS	3/0
ULCK 4/0 HS	4/0
ULCK 250 HS	250
ULCK 300 HS	300
ULCK 350 HS	350
ULCK 400 HS	400
ULCK 500 HS	500
ULCK 600 HS	600
ULCK 750 HS	750
ULCK 1000 HS	1000

Note: For kits with open-ended splice covers, for splices not shown or for reducing kits, please consult your ABB representative.

Flood-Seal ULCK series

Cat. no.	Conductor size (AWG or kcmil)	Splice cover
ULCK 8	#8	FSS 20
ULCK 6	#6	
ULCK 4	#4	
ULCK 2	#2	
ULCK 1	#1	
ULCK 1/0	1/0	
ULCK 2/0	2/0	FSS 350
ULCK 3/0	3/0	
ULCK 4/0	4/0	
ULCK 250	250	
ULCK 300	300	FSS 500L
ULCK 350	350	
ULCK 400	400	
ULCK 500	500	
ULCK 600	600	FSS 1000
ULCK 750	750	
ULCK 800	800	
ULCK 1000	1000	

Aluminum mechanical splice kits

Aluminum Flood-Seal® mechanical splice kits

Range taking – no compression tools and dies required.

- Prefilled with oxide inhibitor to prevent oxidation and keep out moisture
- Dual-rated and approved for use with aluminum or copper conductors

- EPDM rubber splice covers ensure a fully insulated, watertight repair splice – there's no taping, heat shrink or mastic required
- Sized for most conductors perfect for repairing any 2-, 3- or 4-wire installation
- RUS Accepted

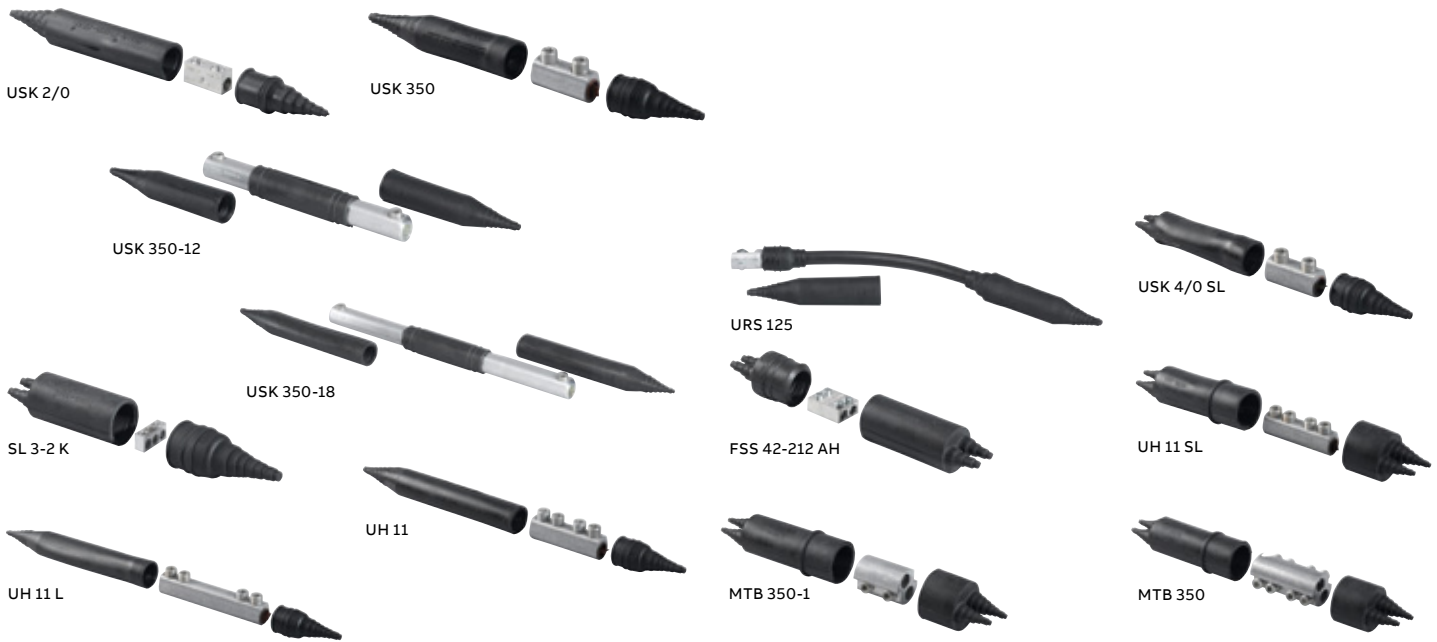

Two-wire kits

Cat. no.	Conductor range (AWG or kcmil)	Connector length (in.)	Number of screws per side
USK 2/0 (slotted screw)	#14–2/0	1½	1
USK 2/0 AH		1½	
USK 4/0	#4–4/0	2	
USK 350*	#6–350	2¾/16	
USK 350-4		4	
USK 350-12*†		12	
USK 350-18*†		18	
UH 11		4¼/16	2
UH 11 L†		6½	
USK 350-12 DS		12	
USK 350-18 DS†		18	
USK 500	#2–500	4¾/16	
USK 500 L†		7½	
USK 500-12†		12	
USK 500-16†		16	
USK 750	250–750	16¾/16	

* UL Listed. † Repair kits.

Kits

Cat. no.	Conductor range (AWG or kcmil)	Connector length (in.)
Compression-type repair kits		
URS 125	#2–350 (standard one-hole lugs)	17½
Three-wire kits		
SL 3-2 K	#4–#14 Cu / #2–#14 Al	3
USK 4/0 SL	Side "A" (#6–350), Side "B" (1/0–4/0 with #6–#14 sol. tap)	Accommodates 3 wires
Four-wire kits		
FSS 42-212 AH	#2–#12	4
UH 11 SL	Side "A" (#6–350), Side "B" (1/0–4/0 with #6–#14 sol. tap)	Accommodates 4 wires
MTB 350-1	#6–350	4
MTB 350		

Aluminum mechanical splice kits

Aluminum Flood-Seal® inline watertight splice kits

—
01 RABS 35012 universal
range-taking splice

—
02 RABS 350250, RABS
4010 and RABS 16
no-cut style splices



—
01



—
02

Watertight connections made easy – no tools, tape or heat shrinking!

Homac Flood-Seal inline watertight splice kits enable you to make watertight splice connections quickly – without the need for time-consuming compression tools, insulating tape or heat-shrink insulation.

- Flood-Seal technology provides superior insulating, waterproofing and UV-resistant performance without tape or shrinks – no heat guns or pull cords
- Rubber-insulated aluminum splices feature mechanical set-screw connections for fast, easy installation resulting in lower installed cost
- Cat. no. RABS 35012 universal range-taking splice accommodates aluminum and copper conductor sizes from #12 AWG to 350 kcmil with only one SKU
- Three dual-rated splices accommodate a wide range of aluminum and copper conductor sizes and require no cutting of insulator for fast, easy installation
- Suitable for direct burial, handhole and overhead applications
- Exceeds ANSI C119.1 requirements

Universal range-taking dual-rated splice

Cat. no.	Conductor size and sealing range (AWG or kcmil)
RABS 35012	#12–350

No-cut style dual-rated splices

Cat. no.	Conductor size and sealing range (AWG or kcmil)
RABS 16	#6–#1
RABS 4010	1/0–4/0
RABS 350250	250–350

Insulating covers and end caps

Flood-Seal® insulating covers



Watertight, fully insulated covers for a variety of splice applications.

- Sizes for most conductors – perfect for copper or aluminum conductors ranging from #14 AWG to 1500 kcmil
- Easy-to-install, waterproof twin-tap covers
- Cut the proper cable rings at each end of the twin-tap cover and slide cover halves over cables; the cover halves are mated, enclosing the compression tap in a waterproof seal
- Eliminates taping to significantly reduce labor and material cost of splice preparation
- Rated 600 volts – built for heavy-duty loads
- RUS Accepted

FSS series



Diagram	Cat. no.	Conductor range (AWG or kcmil)		Cable insulation diameter range (in.)	L (in.)
		Copper	Aluminum		
	FSS 20	#14–2/0	#14–2/0	0.150–0.600	2¼
	FSS 20 L	#14–2/0	#14–2/0	0.150–0.600	3⅞
	FSS 350	#14–350	#14–350	0.150–0.980	4⅞
	FSS 350 L	#14–350	#14–350	0.150–0.980	7½
	FSS 500	#14–500	#14–500*	0.150–1.175	4⅞
	FSS 500 L	#14–500	#14–500	0.150–1.175	7⅞
	FSS 1000 S	#2–1000	#2–750	0.370–1.600	5
	FSS 1000	#2–1000	#2–1000	0.370–1.600	10
	FSS 1000-16	#2–1000	#2–1000	0.370–1.600	13⅜
	FSS 1000 L	#2–1500	#2–1000	0.370–1.600	18⅞

* For 500 kcmil aluminum, remove liner from cap.

Twin-tap*

Diagrams	Cat. No.	Conductor range (AWG or kcmil)		
		A	B	C
	FSS 1010-4	#14–1/0	#14–1/0	–
	FSS 4010-4	#14–250	#14–1/0	–
	FSS 4010-4 L	#8–250	#14–1/0	–
	FSS 4040	#14–500	#14–250	#14–250
	FSS 4040 L	#14–500	#8–250	#14–2/0
	FSS 5010	#14–500	#14–2/0	#14–2/0
	FSS 5035	#2–1500	#14–500	#14–400
	FSS 5035-4	#14–500	#14–400	–

* Not UL Listed.

Insulating covers and end caps

Flood-Seal® cable end caps



Cap off your cable with our cable end caps.

- EPDM rubber construction and multiple internal sealing ring design enables each cap to fit wide decimal range
- Reusable to save money
- Durable and unaffected by sun, rain or soil
- Tight fitting to prevent accidental removal
- Watertight – doesn't require tape, compound or heat source for fitting
- Dielectrically tested to ANSI C119.1 requirement (2,200 volts AC for one minute)

Cable end caps – 660 V cable application

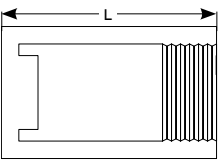
	Cat. no.	L (in.)	Cable size decimal range				Cable size (AWG or kcmil)					
			in.		mm		Concentric		Compressed		Compact	
			Min.	Max.	Min.	Max.	Min.	Max.	Min.	Max.	Min.	Max.
Diagram	CAP 35	$\frac{3}{4}$	0.250	0.425	6.4	10.8	#6	#2	#6	#2	#6	#2
	CAP 45	$\frac{7}{8}$	0.360	0.562	9.1	14.3	#2	1/0	#2	1/0	#2	2/0
	CAP 55	1	0.455	0.626	11.6	15.9	#1	3/0	#1	3/0	#1	3/0
	CAP 65	1 $\frac{1}{4}$	0.575	0.750	14.6	19.0	2/0	250	3/0	300	3/0	300
	CAP 85	1 $\frac{3}{8}$	0.720	0.973	18.3	24.7	250	400	350	400	250	400
	CAP 95*	1 $\frac{7}{8}$	0.970	1.185	24.6	30.1	500	700	500	750	600	800
	CAP 105*	2 $\frac{1}{8}$	1.120	1.400	28.4	35.6	750	1000	750	1000	800	1000
	CAP 125*	2 $\frac{3}{8}$	1.200	1.475	30.5	37.5	750	1000	750	1000	800	1000
	CAP 130*	2 $\frac{1}{2}$	1.390	1.650	35.3	41.9	1233.7	1250	–	–	–	–
	CAP 135*	2 $\frac{5}{8}$	1.465	1.750	37.2	44.5	1500	1578.8	–	–	–	–
	CAP 145*	2 $\frac{7}{8}$	1.650	1.925	41.9	49.0	1973.5	2000	–	–	–	–
	CAP 150*	3	1.860	2.230	47.2	56.6						Fits high-voltage cable only
	CAP 155*	3	2.150	2.500	54.6	63.5						Fits high-voltage cable only

* Indicates cap with internal protective button.

Note: Conductor ranges shown are for outer diameter over cable insulation.
For cable sizes not listed, please consult your ABB representative.

Pipe and conduit seals



Flood-Seal® pipe/conduit seals



Rubber-insulated end caps for commercial pipes and conduits.

- Flood-Seal EPDM rubber seals out water, insects, rodents and dirt
- Durable and unaffected by sun, rain or soil
- Ideal for installations or cable replacements
- Tight fitting to prevent accidental removal

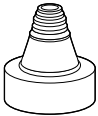
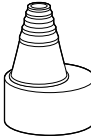
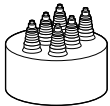
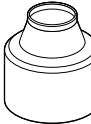
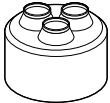
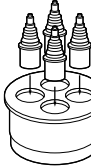
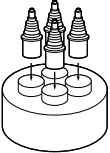
Flood-Seal® pipe/conduit seals

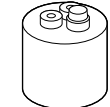
Diagrams	Cat. no.	Pipe size		Conductor (AWG or kcmil)	Ranges		Outside body length (in.)
		(IPS)	Style		Decimal		
 Style 1 No Outlets	CIC 75-3	¾	10	#14-#10	-	1½	
	CIC 50-3	½	10	#14-#10	-	1¾	
 Style 2 1 Outlet	CIC 1-4	1	4	(4)#14-#4	SL-0.380	2 ¹³ / ₃₂	
	CIC 150	1½	5	-	0.720-1.200	1¾	
 Style 3 1 Outlet	CIC 15-320		6	(3)#2-2/0	0.370-0.580	1¾	
	CIC 15-420		6	(4)#2-2/0	0.370-0.580	1¾	
 Style 4 2, 3, 4 or 6 Outlets	C-5230	2	4	(2)#14-350, (1)#14-1/0	SL-0.910, SL-0.540	1½	
	C-5035		4	(1)#14-400, (1)#14-500	SL-0.980, SL-1.175	1 ¹⁵ / ₁₆	
 Style 5 1 Outlet	C-5231		4	(3)#14-350, (1)#14-4/0	SL-0.980, SL-0.690	2	
	CIC 200		5	-	1.093-1.562	2	
 Style 6 3 or 4 Outlets	CIC 201		5	-	0.937-1.145	4	
	PS 2		7	(3)#14-250	SL-0.765	1 ³ / ₁₆	
 Style 7 3 or 4 Outlets	3133	2½	2	300-1500	0.760-1.880	2¾	
	3133-6		2	300-1500	0.760-1.880	6¾	
 Style 8 4 Outlets	CIC 25-440		4	(4)#2-4/0	0.390-0.690	2¼	
	CAP 250		1	-	-	3	
 Style 9 2 or 4 Outlets	PS 25		7	(2)#14-350, (1)#14-250	SL-0.980, SL-0.765	1 ³ / ₁₆	
	3135	3	2	350-2000	0.830-2.234	2½	
 Style 10 3 Outlets	CAP 300		1	-	-	2½	
	CVC 3*		6	-	(3)1.093-1.562	2 ¹¹ / ₁₆	
	CNC 3-1G		9	-	(1)1.031-1.531, (1).280-0.420	2½	
	PS 3		7	(3)#14-350, (1)#14-250	SL-0.980, SL-0.765	1 ³ / ₁₆	
	PSX 3	3½	9	(3)#14-350, (1)#14-250	SL-0.980, SL-0.765	2½	
	PSX 35		8	(3)#14-500, (1)#14-250 & 350-500	SL-1.175 SL-0.765	3 ¹⁵ / ₁₆	
	3138	4	4	#14-400	SL-0.980	2	
	6318		3	-	1.500-3.00	2 ¹¹ / ₁₆	
	CAP 400		1	-	-	2 ¹¹ / ₁₆	
	CNC 4-1G		9	-	(1)1.031-1.531, (1).280-0.420	2¾	
	CVC 4*		6	-	(3)1.125-1.875	3 ³ / ₁₆	
	PS 4		7	(3)#14-500, (1)#14-350	SL-1.175, SL-0.980	1¾	
	CIC 401		2	-	0.830-2.234	3¾	
	CAP 500	5	1	-	-	2 ¹⁵ / ₁₆	
	CVC 5*		6	-	1.250-2.00	3 ⁷ / ₁₆	
	PS 5		7	(3)#2-1500, (1)#14-500	0.370-1.600, SL-1.175	2¾	
	PS 6	6	7	(4)#2-1500	0.370-1.600	2¾	

* Vent cap, not watertight. Note: For sizes not listed, please consult your ABB representative.

Breakaway street light kits

Flood-Seal® street and highway lighting compression fuse and non-fused kits – In-line

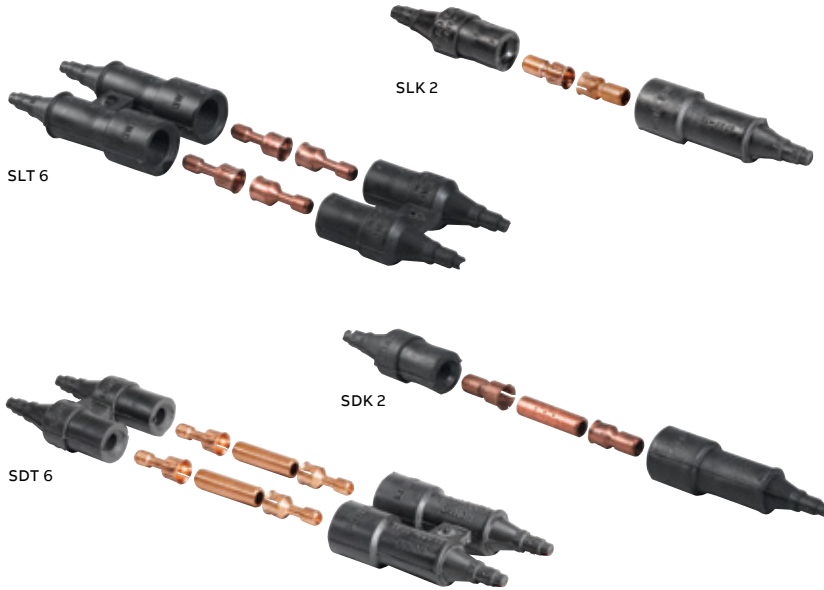

Everything you need for copper connections to roadway lighting.

Copper in-line fuse kits include Flood-Seal housing, fuse clips, silicone lubricant and instruction sheet. Fuse is not included. Fuse kits accept non-glass standard cartridge fuses of $\frac{13}{32}$ " diameter and $1\frac{1}{2}$ " length. Copper in-line non-fused kits include Flood-Seal housing, connecting link, silicone lubricant and instruction sheet.

- EPDM rubber housing ensures a fully insulated, watertight and submersible connection
- Breakaway design separates under tension so wires don't break
- Safe separations – fuse or connecting link stays in covered load side when separated
- Rated for 600 V, 30 A maximum – perfect for heavy-duty applications

Compression in-line fuse kits

Single housing Cat. no.	Twin housing Cat. no.	Cu wire size (AWG)			Installation tool
		Str.	Sol.		
SLK 6	SLT 6	#14–#10	#14–#8	ABB WT111M, C die or equal	
		#8–#6	#6–#4	ABB TBM20S, blue die or equal	
SLK 2	SLT 2	#4	#2	ABB TBM20S, gray die or equal	
		#2	–	ABB TBM20S, brown die or equal	

Single housing Cat. no.	Twin housing Cat. no.	Cu wire size (AWG)		Installation tool	Cu wire size (AWG)		Installation tool
		Str.	Sol.		Str.	Sol.	
SLK 6–2	SLT 6–2	#14–#10	#14–#8	ABB WT111M, C die or equal	#4	#2	ABB TBM20S, gray die or equal
		#8–#6	#6–#4		ABB TBM20S, blue die or equal	#2	

Compression in-line non-fused kits

Single housing Cat. no.	Twin housing Cat. no.	Cu wire size (AWG)			Installation tool
		Str.	Sol.		
SDK 6	SDT 6	#14–#10	#14–#8	ABB WT111M, C die or equal	
		#8–#6	#6–#4	ABB TBM20S, blue die or equal	
SDK 2	SDT 2	#4	#2	ABB TBM20S, gray die or equal	
		#2	–	ABB TBM20S, brown die or equal	

Single housing Cat. no.	Twin housing Cat. no.	Cu wire size (AWG)		Installation tool	Cu wire size (AWG)		Installation tool
		Str.	Sol.		Str.	Sol.	
SDK 6–2	SDT 6–2	#14–#10	#14–#8	ABB WT111M, C die or equal	#4	#2	ABB TBM20S, gray die or equal
		#8–#6	#6–#4		ABB TBM20S, blue die or equal	#2	

Note: For 60 A options, add "-60" suffix to the catalog number.
For larger wire sizes, please consult your ABB representative.

Breakaway street light kits

Flood-Seal® street and highway lighting mechanical fuse and disconnect kits – Y-type



Ideal for heavy-duty applications.

Aluminum and copper Y-type fuse kits include Flood-Seal housing, fuse clips, two aluminum lugs, hardware, silicone lubricant and instruction sheet. Fuse is not included. Aluminum and copper Y-type disconnect kits include Flood-Seal housing, fuse clips, connecting link, two aluminum or copper lugs, hardware, silicone lubricant and instruction sheet.

- EPDM rubber housing ensures a fully insulated, watertight and submersible connection
- Safe separations – fuse or connecting link stays in covered load side when separated
- Dual-rated and approved for a wide range of aluminum or copper conductors
- Rated for 600 V, 30 A maximum – perfect for heavy-duty applications
- Some fuse kits can even accept a 60 A fuse

600 Volt, 30 amp max., fused

Cat. no.	Wire size stranded (AWG)	Fused/non-fused	Installing dies
FYA-6	#6	Fused (aluminum run, copper tap)	52, BG, 243, 5/8
FYA-4	#4		52, BG, 243, 5/8
FYA-2	#2		52, BG, 243, 5/8
FYA-1/0	1/0		52, BG, 243, 5/8
FYA-2/0	2/0		58, 297, 245, 5/8-1
FYC-8	#8	Fused (copper run, copper tap)	1/4, 6, TC, 21
FYC-6	#6		J, 7, TE, 24
FYC-4	#4		5/16, 8, TP, 29
FYC-2	#2		3/8, 10, TL-TN, 33
FYC-1	#1		3/8, 11K TB, 37
FYC-1/0	1/0		1/2, 12, TQ, 42
FYC-2/0	2/0		9/16, 13, TS, 45

Note: If fixture or tap wire is aluminum, add the following suffixes to the catalog number:
 -2A for 14–10 AWG stranded or 12–8 AWG solid. For example, FYC 1/0-2A.
 -3A for 8–6 AWG stranded or 6–4 AWG solid. For example, FYA 1/0-3A.

600 Volt, 30 amp max., non-fused

Cat. no.	Wire size stranded (AWG)	Fused/non-fused	Installing dies
DYA-6	#6	Non-fused (aluminum run, copper tap)	52, BG, 243, 5/8
DYA-4	#4		52, BG, 243, 5/8
DYA-2	#2		52, BG, 243, 5/8
DYA-1/0	1/0		52, BG, 243, 5/8
DYA-2/0	2/0		58, 297, 245, 5/8-1
DYC-8	#8	Non-fused (copper run, copper tap)	1/4, 6, TC, 21
DYC-6	#6		J, TE, 24
DYC-4	#4		5/16, 8, TP, 29
DYC-2	#2		3/8, 10, TL-TN, 33
DYC-1	#1		3/8, 11K TB, 37
DYC-1/0	1/0		1/2, 12, TQ, 42
DYC-2/0	2/0		9/16, 13, TS, 45

Diagram

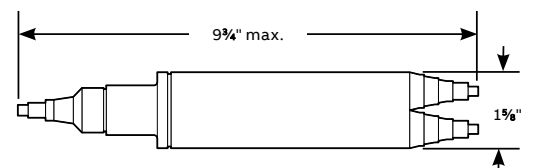

Breakaway street light kits

Flood-Seal® street and highway lighting mechanical fuse and disconnect kits – In-line

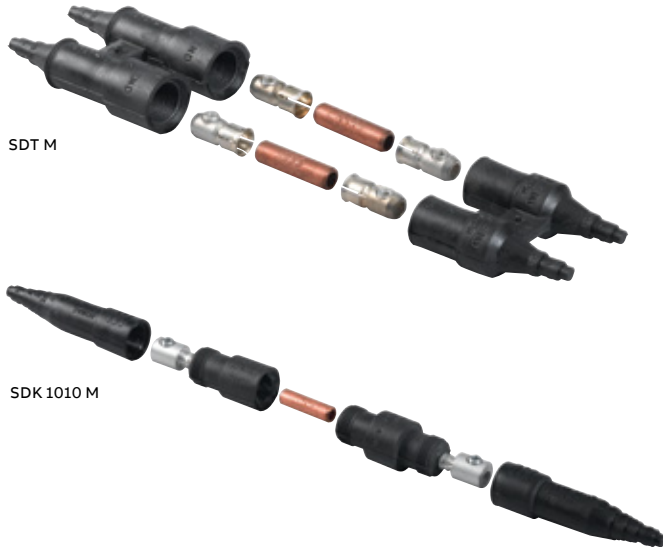

In-line mechanical kit options for aluminum or copper conductors.

In-line fuse kits include Flood-Seal housing, fuse clips, silicone lubricant and instruction sheet. Fuse is not included. Fuse kits accept non-glass standard cartridge fuses of $\frac{13}{32}$ " diameter and $1\frac{1}{2}$ " length. SLK 22-60 M, SLK 102-60 M and SLK 1010-60 M fuse kits can also accept a 60 A fuse measuring $2\frac{1}{4}$ " long. In-line non-fused kits include Flood-Seal housing, connecting link, silicone lubricant and instruction sheet.

- EPDM rubber housing ensures a fully insulated, watertight and submersible connection
- Safe separations – fuse or connecting link stays in covered load side when separated
- Dual-rated and approved for a wide range of aluminum or copper conductors
- Rated for 600 V, 30 A maximum – perfect for heavy-duty applications
- Some fuse kits can even accept a 60 A fuse

Flood-Seal street and highway lighting mechanical fuse and disconnect kits – In-line

Cat. no.	Fused/non-fused	Conductor range (Al/Cu) (AWG)	
		Stranded	Solid
In-line kits			
SLK M	Fused	#12, #10, #8, #6, #4	#12, #10, #8, #6, #4
SLT M [†]			
SDK M	Non-fused		
SDT M [†]			
In-line variable-range kits			
SLK 22 M	Fused	#2–#14	#2–#14
SLK 102 M		1/0–#2	#2–#14
SLK 1010 M		1/0–#2	1/0–#2
SLK 22-60 M*		#2–#14	#2–#14
SLK 102-60 M*		1/0–#2	#2–#14
SLK 1010-60 M*		1/0–#2	1/0–#2
SDK 22 M	Non-fused	#2–#14	#2–#14
SDK 102 M		1/0–#2	#2–#14
SDK 1010 M		1/0–#2	1/0–#2

[†] Indicates twin housing.

* 60A fuse max. 60A fuses are $2\frac{1}{4}$ " long.

Note: 600V, 30A fuse not included. Fused kits accept standard cartridge fuse with $\frac{13}{32}$ " diameter, $1\frac{1}{2}$ " length, non-glass type.

Breakaway street light kits

Flood-Seal® street and highway lighting mechanical fuse and disconnect kits – Y-type



FYU 2

Standard and mechanical run compression tap kits for your roadway lighting jobs.

Mechanical Y-type fuse kits include Flood-Seal housing, fuse clips, dowel and silicone lubricant. Fuse is not included. Fuse kits accept non-glass standard cartridge fuses of $\frac{13}{32}$ " diameter and 1½" length.

- EPDM Flood-Seal housing ensures a fully insulated, watertight and submersible connection
- Breakaway design separates under tension so wires don't break
- Safe separations – fuse or connecting link stays in covered load side when separated
- Matching ampacity rating – run or feeder lugs have the same ampacity rating as the cable, up to 2/0 AWG
- Rated for 600 V, 30 A maximum – perfect for heavy-duty applications
- Y-type mechanical run compression taps use a ½" hex wrench for easy installation

Flood-Seal street and highway lighting mechanical fuse and disconnect kits – Y-type

Cat. no.	Fused/non-fused	Conductor range (Al/Cu) (AWG)	
		Main	Tap
Y-type disconnect kits			
FYU M	Fused	#14-#2	#12-#4
DYU M	Non-fused		
Y-line mechanical run compression kits			
FYU 6	Fused	#14-#2	#14-#6
FYU 2			#4-#2
DYU 6	Non-fused		#14-#6
DYU 2			#4-#2

Mechanical street light connectors

Flood-Seal® street and highway lighting mechanical connectors



RAB 1/0-4
(Style 1)

Two connector styles to match your application.

- EPDM Flood-Seal housing ensures a fully insulated, watertight and submersible connection
- Dual-rated to accept aluminum or copper conductors ranging from #14 to 1/0 AWG.

Flood-Seal® street and highway lighting mechanical connectors

Style	Cat. no.	Conductor range (AWG)	Outlets
	RAB 1/0-2	#14 – 1/0	2
	RAB 1/0-3		3
	RAB 1/0-4		4
	RAB 1/0-5		5
	RAB 1/0-6		6
	RAB 1/0-7		7
	RAB 1/0-8		8
	RAB 1/0-9		9
	RAB 1/0-10		10
			RAB 1/0-21
RAB 1/0-22		4	
RAB 1/0-31		4	
RAB 1/0-32		5	
RAB 1/0-33		6	
RAB 1/0-42		6	

Note: For oxide-inhibitor option, add "-C" suffix to the catalog number.

Mechanical street light connectors

Insulated street and highway lighting mechanical connectors



RB 210-8 SL



SLV 42-212



BY 320

Insulated connectors for above-ground applications.

- Rubber insulation ensures an insulated connection
- Models with street light connectors fit a range of mains and taps
- SLV series features clear PVC to enable safe and time-saving installation
- SLV series sized for a range of conductors – perfect for multiple installation types
- BY series features a PVC boot and locking insulator to ensure a fully insulated connection; the connector stays on until removal is necessary

Insulated street and highway lighting mechanical connectors

Cat. no.	Conductor range (AWG)
RB series – Rubber insulated	
RB 210-8 SL	Main 1/0 max., tap #12 – #8
RB 210-8 SS	Main 1/0 max., tap #12 – #8
RB 6240 SL	Main 2/0 – #14, tap #14 – #6
SLV series – Clear PVC encapsulated	
SLV 240-24	Main (2) 4/0 – #6, tap (2) #4 – #14
SLV 42-212	#12 – #2
BY series – PVC insulated	
BY 320	#14 – 2/0

Note: For oxide-inhibitor option, add “-C” suffix to the catalog number.

Equipment locks



ELB



ELB 2

Rugged, reliable protection for your pad-mount transformers.

- Shear-head screw provides tamper-proof security for your transformer connector equipment
- Three models available – secure your equipment with a mix of all three models for added protection

Equipment locks

Cat. no.	Figure no.	Dimensions (in.)				Alumoweld gauge
		L1	L2	W1	W2	
ELB	1	2.13	1.25	1.06	0.94	6
ELB 2	2	2.19	1.25	2.00	1.00	4
ELB 2 A	3	3.00	1.69	2.00	1.06	4

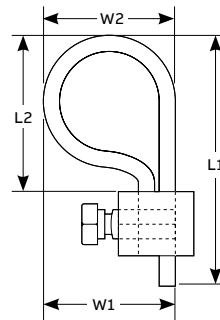

Figure 1

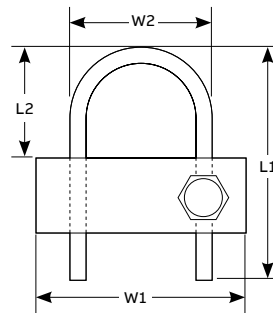

Figure 2

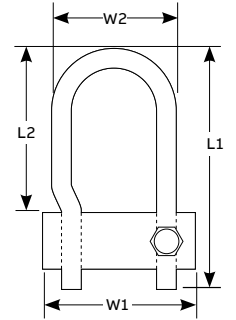

Figure 3

Sealants and lubricants

HOM-OX oxide inhibitor



Seals electrical connections from oxygen and moisture.

- Fully compatible with all solid insulating materials, including rubber, paper and impregnating oils
- Stable over a wide operating temperature range of -40 °F to 300 °F
- HM 52 and HM 56 are also joint compounds for making full-tension splices and aluminum cable connections, respectively

HOM-OX oxide Inhibitor

Cat. no.	Description
HM 52 (1/2 PINT)	Oxide-inhibiting joint compound for full-tension splices only. ½ Pint (8 fl. oz.)
HM 53 (1/2 PINT)	Oxide-inhibiting compound for non-tension splices or pad-to-pad applications. ½ Pint (8 fl. oz.)
HM 56 (1/2 PINT)	Oxide-inhibiting joint compound for overhead compression, partial-tension splices, service entrance and pin terminals. ½ Pint (8 fl. oz.)

Note: For larger container sizes, please consult your ABB representative.

EC-S8C oxide inhibitor



Stop surface oxides from interfering with current transfer between electrical components.

- Use on aluminum-to-aluminum, aluminum-to-copper and copper-to-copper applications
- Safe for use on cables – does not affect rubber or cable insulation; does not contain grit
- Stable over a wide operating temperature range of 0 °F to 460 °F
- Non water-soluble, non petroleum-based polymer grease does not stain

EC-S8C oxide inhibitor

Cat. no.	Description
EC-S8C	Oxide-inhibiting joint compound. ½ Pint (8 fl. oz.)

Note: For a more effective electrical connection, all conductors need to be wire-brushed right before the application of this compound. Wire brushing is not recommended on tin-plated components.

Sealants and lubricants

Thread lubricant



- Versatile use
- Aids in installations and splices

Thread lubricant

Cat. no.	Description
TL 101 (1/2 PINT)	Thread lubricant, ½ pint (8 fl. oz.)

Silicone lubricant for high-voltage electrical work



- Specially formulated for high-voltage cable
- Best used in heavy-duty electrical applications
- Eases installation of cables in Flood-Seal® rockets

Silicone lubricant for high-voltage electrical work

Cat. no.	Description
SL5	0.5 oz. tube

Blackburn® WW wire bristle brush



- Remove oxides from conductor surfaces.
- Easy-grip handle with glove guard prevents rubber glove puncture
 - Long-life wire elements can be rotated and are replaceable
 - Handle and guard coated with durable, non-conductive plastic for safety

Blackburn WW wire bristle brush

Cat. no.	Description
WWB1	Complete brush with handle
WRB1	Wire element only, pair

Appendix

Part number index

Cat. no.	Page	Cat. no.	Page	Cat. no.	Page
2042-1	21	ABC 5500	54	ABK 81-7024 R	23
2042-10	21	ABC 5750	54	ABK 8750	22
2042-11	21	ABC 6350	54	ABK 8750-ML	22
2042-2	21	ABC 640	54	ABK 881000	23
2042-3	21	ABC 6500	54	ABK 881-7024	23
2042-4	21	ABC 6750	54	ABN 2350	29
2042-5	21	ABC 7350	54	ABN 240	29
2042-6	21	ABC 740	54	ABN 2500	29
2042-7	21	ABC 7500	54	ABN 2750	29
2042-8	21	ABC 750-22	55	ABN 3350	29
2042-9	21	ABC 750-33	55	ABN 340	29
2043-1	20	ABC 750-44	55	ABN 3500	29
2043-10	20	ABC 7750	54	ABN 3750	29
2043-2	20	ABC 8350	54	ABN 4350	29
2043-3	20	ABC 840	54	ABN 440	29
2043-4	20	ABC 8500	54	ABN 4500	29
2043-5	20	ABC 8750	54	ABN 4750	29
2043-6	20	ABCK 6350	53	ABN 5350	29
2043-7	20	ABCK 6600	53	ABN 540	29
2043-8	20	ABCK 6600 DS	53	ABN 5500	29
2043-9	20	ABD 4350 SL	11	ABN 5750	29
2135 K	19	ABD 4350-1 SL	11	ABN 6350	29
2250-1 K	19	ABD 6350 SL	11	ABN 640	29
3133	71	ABD 6350-1 SL	11	ABN 6500	29
3133-6	71	ABD 8350 SL	11	ABN 6750	29
3135	71	ABD 8350-1 SL	11	ABN 7350	29
3138	71	ABK 11000	22	ABN 740	29
6318	71	ABK 11000 SSN	22	ABN 7500	29
ABC 2350	54	ABK 1600 DS	22	ABN 7750	29
ABC 240	54	ABK 1750	22	ABN 8350	29
ABC 2500	54	ABK 1750-ML	22	ABN 840	29
ABC 2750	54	ABK 21000	22	ABN 8500	29
ABC 3350	54	ABK 221000	23	ABN 8750	29
ABC 340	54	ABK 2750	22	ABS 2350	8
ABC 3500	54	ABK 2750-ML	22	ABS 240	8
ABC 350-22	55	ABK 31000	22	ABS 2500	8
ABC 350-33	55	ABK 331000	23	ABS 2750	8
ABC 350-44	55	ABK 3750	22	ABS 3350	8
ABC 3750	54	ABK 3750-ML	22	ABS 340	8
ABC 40-22	55	ABK 41000	22	ABS 3500	8
ABC 40-33	55	ABK 441000	23	ABS 350-22	9
ABC 40-44	55	ABK 4600 DS	22	ABS 350-33	9
ABC 4350	54	ABK 4750	22	ABS 350-44	9
ABC 440	54	ABK 4750-ML	22	ABS 3750	8
ABC 4500	54	ABK 61000	22	ABS 40-22	9
ABC 4750	54	ABK 6600 DS	22	ABS 40-33	9
ABC 500-22	55	ABK 661000	23	ABS 40-44	9
ABC 500-33	55	ABK 6750	22	ABS 4350	8
ABC 500-44	55	ABK 6750-ML	22	ABS 4350-1	8
ABC 5350	54	ABK 81000	22	ABS 440	8
ABC 540	54	ABK 81-7024 L	23	ABS 4500	8

Appendix

Part number index

Cat. no.	Page	Cat. no.	Page	Cat. no.	Page
ABS 4750	8	ABT 6350	26	ABW 750-22	7
ABS 500-22	9	ABT 6350-48	26	ABW 750-33	7
ABS 500-33	9	ABT 640	26	ABW 750-44	7
ABS 500-44	9	ABT 640-48	26	ABW 7750	6
ABS 5350	8	ABT 6500	26	ABW 8350	6
ABS 540	8	ABT 6500 DS	27	ABW 8350-1	6
ABS 5500	8	ABT 6500-48	26	ABW 840	6
ABS 5750	8	ABT 6750	27	ABW 8500	6
ABS 6350	8	ABT 81000	27	ABW 8750	6
ABS 6350-1	8	ABT 8350	26	AD 1	12
ABS 640	8	ABT 8350-48	26	AD 58	12
ABS 6500	8	ABT 840	26	AK 600 N	22
ABS 6750	8	ABT 840-48	26	BB 10	54, 59
ABS 7350	8	ABT 8500	26	BB 11	54, 59
ABS 740	8	ABT 8500 DS	27	BB 12	54, 59
ABS 7500	8	ABT 8500-48	26	BB 13	54, 59
ABS 750-22	9	ABT 8750	27	BB 14	54, 59
ABS 750-33	9	ABW 2350	6	BB 15	54, 59
ABS 750-44	9	ABW 240	6	BB 17	55, 59
ABS 7750	8	ABW 2500	6	BBV4N	34
ABS 8350	8	ABW 2750	6	BY 320	77
ABS 8350-1	8	ABW 3350	6	C-5035	71
ABS 840	8	ABW 340	6	C-5230	71
ABS 8500	8	ABW 3500	6	C-5231	71
ABS 8750	8	ABW 350-22	7	CAP 105	70
ABT 11000	27	ABW 350-33	7	CAP 125	70
ABT 1500 DS	27	ABW 350-44	7	CAP 130	70
ABT 1750	27	ABW 3750	6	CAP 135	70
ABT 21000	27	ABW 40-22	7	CAP 145	70
ABT 2350	26	ABW 40-33	7	CAP 150	70
ABT 2500	26	ABW 40-44	7	CAP 155	70
ABT 2500 DS	27	ABW 4350	6	CAP 250	71
ABT 2750	27	ABW 4350-1	6	CAP 300	71
ABT 31000	27	ABW 440	6	CAP 35	70
ABT 3350	26	ABW 4500	6	CAP 400	71
ABT 3500	26	ABW 4750	6	CAP 45	70
ABT 3500 DS	27	ABW 500-22	7	CAP 500	71
ABT 3750	27	ABW 500-33	7	CAP 55	70
ABT 41000	27	ABW 500-44	7	CAP 65	70
ABT 4350	26	ABW 5350	6	CAP 85	70
ABT 4350-48	26	ABW 540	6	CAP 95	70
ABT 440	26	ABW 5500	6	CBB 3344	16–17
ABT 440-48	26	ABW 5750	6	CFB 250 CS	45
ABT 4500	26	ABW 6350	6	CFB 250 HS	45
ABT 4500 DS	27	ABW 6350-1	6	CFB 300 CS	45
ABT 4500-48	26	ABW 640	6	CFB 300 HS	45
ABT 4750	27	ABW 6500	6	CFB 350 CS	45
ABT 5500	26	ABW 6750	6	CFB 350 HS	45
ABT 5500 DS	27	ABW 7350	6	CFG 1 CS	45
ABT 5750	27	ABW 740	6	CFG 1 HS	45
ABT 61000	27	ABW 7500	6	CFG 1/0 CS	45

Appendix

Part number index

Cat. no.	Page	Cat. no.	Page	Cat. no.	Page
CFG 1/0 HS	45	CSS 8350	5	EZB 6500 SL	4
CFG 2 CS	45	CSS 8350-1	5	EZB 8350 SL	4
CFG 2 HS	45	CSS 8500	5	EZB 8500 SL	4
CFG 4 CS	45	CSS 8500-58	5	EZB 8750 SL	4
CFG 4 HS	45	CSW 4350	5	EZC 4350 SL	4
CFG 6 CS	45	CSW 4350-1	5	EZC 4500 SL	4
CFG 6 HS	45	CSW 4500	5	EZC 6350 SL	4
CFG 8 CS	45	CSW 4500-58	5	EZC 6500 SL	4
CFG 8 HS	45	CSW 6350	5	EZC 8350 SL	4
CFK 1/0 CS	45	CSW 6350-1	5	EZC 8500 SL	4
CFK 1/0 HS	45	CSW 6500	5	EZC 8750 SL	4
CFK 2/0 CS	45	CSW 6500-58	5	FB 33	55, 59
CFK 2/0 HS	45	CSW 8350	5	FB 6 L	59
CFK 250 CS	45	CSW 8350-1	5	FS 1010-175	50
CFK 250 HS	45	CSW 8500	5	FS 1010-175 CU	51
CFK 3/0 CS	45	CSW 8500-58	5	FS 10-125	46
CFK 3/0 HS	45	CTSC 10	32	FS 111-125	47
CFK 4/0 CS	45	CTSC 12	32	FS 11-48	46
CFK 4/0 HS	45	CTSC 4-10	32	FS 1212-175	50
CIC 1-4	71	CTSC 4-12	32	FS 1212-175 CU	51
CIC 150	71	CTSC 4-6	32	FS 175 DPK	52
CIC 15-320	71	CTSC 4-8	32	FS 175-2	50
CIC 15-420	71	CTSC 6	32	FS 175-2 CU	51
CIC 200	71	CTSC 8	32	FS 175-3	50
CIC 201	71	CVC 3	71	FS 175-3 CU	51
CIC 25-440	71	CVC 4	71	FS 175-4	50
CIC 401	71	CVC 5	71	FS 175-4 CU	51
CIC 50-3	71	DYA-1/0	73	FS 175-5	50
CIC 75-3	71	DYA-2	73	FS 175-5 CU	51
CLR 3350	58	DYA-2/0	73	FS 175-6	50
CLR 340	58	DYA-4	73	FS 175-6 CU	51
CLR 4350	58	DYA-6	73	FS 175-7	50
CLR 440	58	DYC-1	73	FS 175-7 CU	51
CLR 5350	58	DYC-1/0	73	FS 175-8	50
CLR 540	58	DYC-2	73	FS 175-8 CU	51
CLR 6350	58	DYC-2/0	73	FS 21-125	47
CLR 640	58	DYC-4	73	FS 212-125	47
CLRTR 4	11	DYC-6	73	FS 2-125	46
CLRTR 45-58	11	DYC-8	73	FS 22-175	50
CLRTR 6	11	DYU 2	75	FS 22-175 CU	51
CLRTR 65-58	11	DYU 6	75	FS 222-125	47
CNC 3-1G	71	DYU M	75	FS 22-48	46
CNC 4-1G	71	EC-S8C	79	FS 31-125	47
CSS 4350	5	ELB	78	FS 3-125	46
CSS 4350-1	5	ELB 2	78	FS 313-125	47
CSS 4500	5	ELB 2 A	78	FS 323-125	47
CSS 4500-58	5	EZ 5912-3	13	FS 33-175	50
CSS 6350	5	EZ 5912-7	13	FS 33-175 CU	51
CSS 6350-1	5	EZB 4350 SL	4	FS 33-48	46
CSS 6500	5	EZB 4500 SL	4	FS 41-125	47
CSS 6500-58	5	EZB 6350 SL	4	FS 4-125	46

Appendix

Part number index

Cat. no.	Page	Cat. no.	Page	Cat. no.	Page
FS 414-125	47	FSK 750	64	FT 95-4-1	18
FS 44-175	50	FSK 750 R 500	64	FT 95-44	18
FS 44-175 CU	51	FSN 10-125	46	FT 95-44-1	18
FS 44-48	46	FSN 11	46	FT 95-5	18
FS 5-125	46	FSN 2-125	46	FT 95-5-1	18
FS 55-175	50	FSN 22	46	FT 95-55	18
FS 55-175 CU	51	FSN 3-125	46	FT 95-55-1	18
FS 55-48	46	FSN 33	46	FT 95-6	18
FS 6-125	46	FSN 4-125	46	FT 95-6-1	18
FS 66-175	50	FSN 44	46	FT 95-66	18
FS 66-175 CU	51	FSN 5-125	46	FT 95-66-1	18
FS 66-48	46	FSN 55	46	FTH 22-175-15	33
FS 7-125	46	FSN 6-125	46	FTH 22-175-30	33
FS 77-48	46	FSN 66	46	FTH 33-175-15	33
FS 8-125	46	FSN 7-125	46	FTH 33-175-30	33
FS 88-175	50	FSN 77	46	FTH 44-175-15	33
FS 88-175 CU	51	FSN 8-125	46	FTH 44-175-30	33
FS 88-48	46	FSN 88	46	FTH 55-175-15	33
FS 9-125	46	FSN 9-125	46	FTH 55-175-30	33
FS 95-10	44	FSN 99	46	FTN 125-2	30
FS 95-2	44	FSS 1000	69	FTN 125-2N	30
FS 95-3	44	FSS 1000 L	69	FTN 125-3	30
FS 95-4	44	FSS 1000 S	69	FTN 125-3N	30
FS 95-5	44	FSS 1000-16	69	FTN 125-4	30
FS 95-6	44	FSS 1010-4	69	FTN 125-44	30
FS 95-7	44	FSS 20	69	FTN 125-44N	30
FS 95-8	44	FSS 20 L	69	FTN 125-4N	30
FS 95-9	44	FSS 350	69	FTN 125-5	30
FS 99-48	46	FSS 350 L	69	FTN 125-5N	30
FSK 1	64	FSS 4010-4	69	FTN 125-6	30
FSK 1/0	64	FSS 4010-4 L	69	FTN 125-6N	30
FSK 1/0 R 2	64	FSS 4040	69	FTN 175-22	31
FSK 1000	64	FSS 4040 L	69	FTN 175-33	31
FSK 1000 R 500	64	FSS 42-212 AH	67	FTN 175-44	31
FSK 1000 R 750	64	FSS 500	69	FTN 175-44L	31
FSK 2	64	FSS 500 L	69	FTN 175-4R	31
FSK 2/0	64	FSS 5010	69	FTN 175-55	31
FSK 2/0 R 1/0	64	FSS 5035	69	FTN 175-5L	31
FSK 250	64	FSS 5035-4	69	FTN 175-5R	31
FSK 3/0	64	FST 125	47	FTN 175-66	31
FSK 300	64	FSTT 125	47	FTN 175-6L	31
FSK 350	64	FSX 125	47	FTN 175-6R	31
FSK 350 R 4/0	64	FSXX 125	47	FTT 44-175-15	33
FSK 4	64	FSY 125-21	47	FTT 44-175-30	33
FSK 4/0	64	FSY 125-42	47	FTU 1-125-2	19
FSK 4/0 R 2/0	64	FSY 125-64	47	FTU 1-125-3	19
FSK 400	64	FT 95-2	18	FTU 1-125-4	19
FSK 500	64	FT 95-2-1	18	FTU 1-125-44	19
FSK 500 R 350	64	FT 95-3	18	FTU 1-125-5	19
FSK 500 R 4/0	64	FT 95-3-1	18	FTU 1-125-6	19
FSK 600	64	FT 95-4	18	FTU 1-2 N	19

Appendix

Part number index

Cat. no.	Page	Cat. no.	Page	Cat. no.	Page
FTU 125-2	19	FYC-6	73	PS 6	71
FTU 125-3	19	FYC-8	73	PSB4359C	57
FTU 125-4	19	FYU 2	75	PSB4559C	57
FTU 125-44	19	FYU 6	75	PSB6359C	57
FTU 125-5	19	FYU M	75	PSB6559C	57
FTU 125-6	19	HM 52 (1/2 PINT)	79	PSB8359C	57
FTU 1-3 N	19	HM 53 (1/2 PINT)	79	PSB8559C	57
FTU 1-4 N	19	HM 56 (1/2 PINT)	79	PSX 3	71
FTU 1-44 N	19	LRT 2210 W	17	PSX 35	71
FTU 1-5 N	19	LRT 2210 X	17	RAB 1/0-10	40, 76
FTU 1-6 N	19	LRT 2210	17	RAB 1/0-2	40, 76
FTU 2 N	19	LRT 2258 W	17	RAB 1/0-21	40, 76
FTU 3 N	19	LRT 2258 X	17	RAB 1/0-22	40, 76
FTU 4 N	19	LRT 2258	17	RAB 1/0-3	40, 76
FTU 44 N	19	LRT 2350	12	RAB 1/0-31	40, 76
FTU 5 N	19	LRT 33 U	16	RAB 1/0-32	40, 76
FTU 6 N	19	LRT 33 UW	16	RAB 1/0-33	40, 76
FTU 95-2	18	LRT 33 UX	16	RAB 1/0-4	40, 76
FTU 95-2-1	18	LRT 3310 W	17	RAB 1/0-42	40, 76
FTU 95-3	18	LRT 3310 X	17	RAB 1/0-5	40, 76
FTU 95-3-1	18	LRT 3310	17	RAB 1/0-6	40, 76
FTU 95-4	18	LRT 3358 W	17	RAB 1/0-7	40, 76
FTU 95-4-1	18	LRT 3358 X	17	RAB 1/0-8	40, 76
FTU 95-44	18	LRT 3358	17	RAB 1/0-9	40, 76
FTU 95-44-1	18	LRT 4350	12	RAB 10-C	40
FTU 95-5	18	LRT 44 U	16	RAB 2-C	40
FTU 95-5-1	18	LRT 44 UW	16	RAB 35-C	41
FTU 95-55	18	LRT 44 UX	16	RAB 3-C	40
FTU 95-55-1	18	LRT 4410	17	RAB 45-C	41
FTU 95-6	18	LRT 4410 W	17	RAB 4-C	40
FTU 95-6-1	18	LRT 4410 X	17	RAB 55-C	41
FTU 95-66	18	LRT 4458 W	17	RAB 5-C	40
FTU 95-66-1	18	LRT 4458 X	17	RAB 65-C	41
FXL 22-175	52	LRT 4458	17	RAB 6-C	40
FXL 22-175 CU	52	LRT 6350	12	RAB 85-C	41
FXL 33-175	52	LRT 8350	12	RAB 8-C	40
FXL 33-175 CU	52	LRTR 4	10	RABS 16	68
FXL 44-175	52	LRTR 4W	10	RABS 35012	68
FXL 44-175 CU	52	LRTR 6	10	RABS 350250	68
FXL 66-175	52	LRTR 6W	10	RABS 4010	68
FXL 66-175 CU	52	LRTR 8	10	RAU 4500	10
FYA-1/0	73	LRTR 8W	10	RAU 6500	10
FYA-2	73	MTB 350	67	RAU 8500	10
FYA-2/0	73	MTB 350-1	67	RB 210-8 SL	77
FYA-4	73	PB 1 P	59	RB 210-8 SS	77
FYA-6	73	PB 2	59	RB 6240 SL	77
FYC-1	73	PS 2	71	RRK 1	61
FYC-1/0	73	PS 25	71	RRK 1 HS	62
FYC-2	73	PS 3	71	RRK 10	61
FYC-2/0	73	PS 4	71	RRK 10 CU	63
FYC-4	73	PS 5	71	RRK 10 HS	62

Appendix

Part number index

Cat. no.	Page	Cat. no.	Page	Cat. no.	Page
RRK 102	61	RXL 3-C	42	SDT 6	72
RRK 102 HS	62	RXL 4-C	42	SDT 6-2	72
RRK 2	61	RXL 5-C	42	SDT M	74
RRK 2 CU	63	RXL 600-22-C	42	SHC 121	35
RRK 2 HS	62	RXL 600-31-C	42	SHC 2	35
RRK 20	61	RXL 600-33-C	42	SHC 21	35
RRK 20 CU	63	RXL 600-3-C	42	SHC 212	35
RRK 20 HS	62	RXL 600-42-C	42	SHC 22	35
RRK 201	61	RXL 600-4-C	42	SHC 3	35
RRK 201 HS	62	RXL 600-5-C	42	SHC 4	35
RRK 2010	61	RXL 600-6-C	42	SHC 5	35
RRK 2010 HS	62	RXL 6-C	42	SHC 500-2	35
RRK 202	61	RXL 8-C	42	SHC 500-240 SL	36
RRK 202 HS	62	RXM 10	43	SHC 500-3	35
RRK 24	61	RXM 12	43	SHC 500-4	35
RRK 24 HS	62	RXM 2	43	SHC 500-440 SL	36
RRK 250	61	RXM 22	43	SHC 500-5	35
RRK 250 CU	63	RXM 31	43	SHC 500-6	35
RRK 250 HS	62	RXM 33	43	SHC 500-640 SL	36
RRK 30	61	RXM 4	43	SHC 500-8	35
RRK 30 CU	63	RXM 42	43	SHC 6	35
RRK 30 HS	62	RXM 44	43	SHC 8	35
RRK 300	61	RXM 6	43	SL 3-2 K	67
RRK 300 HS	62	RXM 66	43	SL5	80
RRK 3010	61	RXM 8	43	SLA 1	49
RRK 3010 HS	62	SB 11	34	SLK 1010 M	74
RRK 3020	61	SB 14	34	SLK 1010-60 M	74
RRK 3020 HS	62	SB 17	34	SLK 102 M	74
RRK 350	61	SB 2120	34	SLK 102-60 M	74
RRK 350 CU	63	SB 2144	34	SLK 2	72
RRK 350 HS	62	SB 2147	34	SLK 22 M	74
RRK 350300	61	SB 2151	34	SLK 22-60 M	74
RRK 350300 HS	62	SB 2157	34	SLK 6	72
RRK 35040	61	SB 2159	34	SLK 6-2	72
RRK 35040 HS	62	SB 2160	34	SLK M	74
RRK 4	61	SB 2163-10	34	SLT 2	72
RRK 4 HS	62	SB 2163-12	34	SLT 6	72
RRK 40	61	SB 2163-2	34	SLT 6-2	72
RRK 40 CU	63	SB 2163-3	34	SLT M	74
RRK 40 HS	62	SB 2163-4	34	SLV 240-24	77
RRK 4010	61	SB 2163-6	34	SLV 42-212	77
RRK 4010 HS	62	SB 2163-7	34	SPL 6	49
RRK 4020	61	SC	49	SQG 1212	60
RRK 4020 HS	62	SDK 1010 M	74	TL 101 (1/2 PINT)	80
RRK 4030	61	SDK 102 M	74	TSC 10	32
RRK 4030 HS	62	SDK 2	72	TSC 12	32
RRK 40-840	61	SDK 22 M	74	TSC 4-10	32
RRK 40-840 HS	62	SDK 6	72	TSC 4-12	32
RRK 500	61	SDK 6-2	72	TSC 4-6	32
RRK 500 CU	63	SDK M	74	TSC 4-8	32
RRK 500 HS	62	SDT 2	72	TSC 6	32

Appendix

Part number index

Cat. no.	Page	Cat. no.	Page	Cat. no.	Page
TSC 8	32	ULCK 2/0	66	ULSK 500	65
UH 1000-2 R	39	ULCK 2/0 HS	66	ULSK 500 HS	65
UH 1000-21 R	39	ULCK 250	66	ULSK 6	65
UH 1000-22 R	39	ULCK 250 HS	66	ULSK 6 HS	65
UH 1000-222 R	39	ULCK 3/0	66	ULSK 600	65
UH 1000-242 R	39	ULCK 3/0 HS	66	ULSK 600 HS	65
UH 1000-33 R	39	ULCK 300	66	ULSK 750	65
UH 1000-4 R	39	ULCK 300 HS	66	ULSK 750 HS	65
UH 1000-44 R	39	ULCK 350	66	ULSK 8	65
UH 1000-55 R	39	ULCK 350 HS	66	ULSK 800	65
UH 1000-6 R	39	ULCK 4	66	ULSK 800 HS	65
UH 1000-66 R	39	ULCK 4 HS	66	UPC 20	48
UH 1000-8 R	39	ULCK 4/0	66	UPC 22	48
UH 1000-88 R	39	ULCK 4/0 HS	66	UPC 30	48
UH 11	67	ULCK 400	66	UPC 31	48
UH 11 L	67	ULCK 400 HS	66	UPC 33	48
UH 11 SL	67	ULCK 500	66	UPC 40	48
UH 2 R	37	ULCK 500 HS	66	UPC 41	48
UH 22 R	37	ULCK 6	66	UPC 42	48
UH 3 R	37	ULCK 6 HS	66	UPC 44	48
UH 33 R	37	ULCK 600	66	UPC 50	48
UH 4 R	37	ULCK 600 HS	66	UPC 51	48
UH 44 R	37	ULCK 750	66	UPC 52	48
UH 5 R	37	ULCK 750 HS	66	UPC 55	48
UH 500-2 R	37	ULCK 8	66	UPC 60	48
UH 500-3 R	37	ULCK 8 HS	66	UPC 61	48
UH 500-4 R	37	ULCK 800	66	UPC 62	48
UH 500-5 R	37	ULSK 1	65	UPC 66	48
UH 500-6 R	37	ULSK 1 HS	65	UPC 80	48
UH 500-8 R	37	ULSK 1/0	65	UPC 81	48
UH 55 R	37	ULSK 1/0 HS	65	UPC 88	48
UH 6 R	37	ULSK 1000	65	URS 125	67
UH 66 R	37	ULSK 1000 HS	65	USB33S	41
UH 750-235 SLR	38	ULSK 2	65	USB43S	41
UH 750-240 SLR	38	ULSK 2 HS	65	USB53S	41
UH 750-4 SLR	38	ULSK 2/0	65	USB63S	41
UH 750-435 SLR	38	ULSK 2/0 HS	65	USB83S	41
UH 750-440 SLR	38	ULSK 250	65	USK 2/0 AH	67
UH 750-6 SLR	38	ULSK 250 HS	65	USK 2/0	67
UH 750-635 SLR	38	ULSK 3/0	65	USK 350	67
UH 750-640 SLR	38	ULSK 3/0 HS	65	USK 350-12 DS	67
UH 8 R	37	ULSK 300	65	USK 350-12	67
UH 88 R	37	ULSK 300 HS	65	USK 350-18 DS	67
ULCK 1	66	ULSK 350	65	USK 350-18	67
ULCK 1 HS	66	ULSK 350 HS	65	USK 350-4	67
ULCK 1/0	66	ULSK 4	65	USK 4/0	67
ULCK 1/0 HS	66	ULSK 4 HS	65	USK 4/0 SL	67
ULCK 1000	66	ULSK 4/0	65	USK 500	67
ULCK 1000 HS	66	ULSK 4/0 HS	65	USK 500 L	67
ULCK 2	66	ULSK 400	65	USK 500-12	67
ULCK 2 HS	66	ULSK 400 HS	65	USK 500-16	67

Appendix

Part number index

Cat. no.	Page	Cat. no.	Page	Cat. no.	Page
USK 750	67	ZBK 4041	25	ZVB 4043	56
USL 11	49	ZBK 4047	25	ZVB 4045	56
USL 11 H	49	ZBK 6061	25	ZVB 5053	56
USL 30	49	ZBK 6067	25	ZVB 5055	56
USL 30 H	49	ZBK 8081	25	ZVW 2043-58 SL	14
WB 20 P	49	ZBK 8087	25	ZVW 2044 SL	14
WHB 3 P	49	ZBKW 2041-1-2 SLM	24	ZVW 3033 USL	14
WL 2 P	49	ZBKW 2041-1-2 SLRM	24	ZVW 3035 USL	14
WL 3 P	49	ZBKW 3031-1-2 SLCTM	24	ZVW 3037 USL	14
WL 3.5-16	60	ZBKW 3031-1-2 SLRCTM	24	ZVW 3053-58 SL	14
WL 3-12	60	ZBKW 3041-1-2 SLCTM	24	ZVW 3054 SL	14
WL 6137	60	ZBKW 3041-1-2 SLRCTM	24	ZVW 4023 EZSL	13
WLP 10 T	60	ZBKW 3051-1-2 SLM	24	ZVW 4023-1 SL	14
WLP 10 T 18-1.5	60	ZBKW 3051-1-2 SLRM	24	ZVW 4025 EZSL	13
WLP 11 S	60	ZBKW 4061-1-2 SLM	24	ZVW 4025-1 SL	14
WLP-CSP	60	ZBKW 4061-1-2 SLRM	24	ZVW 4043 USL	14
WRB1	80	ZBKW 5071-1-2 SLM	24	ZVW 4045 USL	14
WS 2 P	49	ZBKW 5071-1-2 SLRM	24	ZVW 4047 USL	14
WWB1	80	ZBT 1011	28	ZVW 4064 SL	14
Z 2043-58 SL	15	ZBT 1013	28	ZVW 5033 EZSL	13
Z 2044 SL	15	ZBT 1013-48	28	ZVW 5033-1 SL	14
Z 3033 USL	15	ZBT 1017	28	ZVW 5035 EZSL	13
Z 3035 USL	15	ZBT 1717 DS	28	ZVW 5035-1 SL	14
Z 3037 USL	15	ZBT 2021	28		
Z 3053-58 SL	15	ZBT 2023	28		
Z 3054 SL	15	ZBT 2023-48	28		
Z 4023 EZSL	13	ZBT 2027	28		
Z 4023-1 SL	15	ZBT 2027 DS	28		
Z 4025 EZSL	13	ZBT 3031	28		
Z 4025-1 SL	15	ZBT 3033	28		
Z 4043 USL	15	ZBT 3033-48	28		
Z 4045 USL	15	ZBT 4041	28		
Z 4047 USL	15	ZBT 4043	28		
Z 4064 SL	15	ZBT 4043-48	28		
Z 5033 EZSL	13	ZBT 4047	28		
Z 5033-1 SL	15	ZBT 4047 DS	28		
Z 5035 EZSL	13	ZBT 5053	28		
Z 5035-1 SL	15	ZBT 5053-48	28		
ZBC 2023	56	ZBT 5057	28		
ZBC 2025	56	ZBT 5057 DS	28		
ZBC 3033	56	ZBT 6063	28		
ZBC 3035	56	ZBT 6063-48	28		
ZBC 4043	56	ZBT 6067	28		
ZBC 4045	56	ZBT 6067 DS	28		
ZBC 5053	56	ZBT 8081	28		
ZBC 5055	56	ZBT 8087	28		
ZBK 1017	25	ZBT 8087 DS	28		
ZBK 2021	25	ZVB 2023	56		
ZBK 2027	25	ZVB 2025	56		
ZBK 3031	25	ZVB 3033	56		
ZBK 3037	25	ZVB 3035	56		

Additional information

We reserve the right to make technical changes or modify the contents of this document without prior notice. With regard to purchase orders, the agreed particulars shall prevail. ABB AG does not accept any responsibility whatsoever for potential errors or possible lack of information in this document.

We reserve all rights in this document and in the subject matter and illustrations contained therein. Any reproduction, disclosure to third parties or utilization of its contents – in whole or in parts – is forbidden without prior written consent of ABB AG.



—
US

ABB Installation Products
Electrification Products division
860 Ridge Lake Blvd.
Memphis, TN 38120
+1 901-252-5000

tnb.abb.com