

Fittings and Brackets

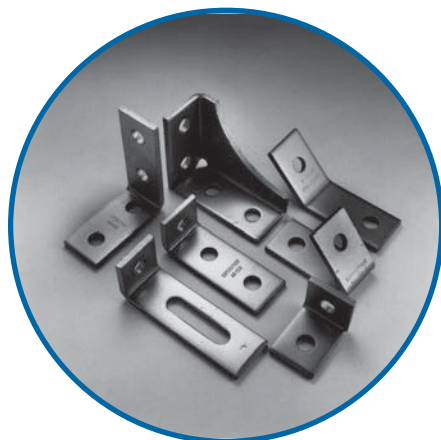

Material

Superstrut® fittings and brackets are manufactured from hot rolled carbon steel.

Dimensions

The following standard dimensions apply to all fittings except as indicated on the individual drawings.

Hole spacing 13/16 in. from end of fittings

Hole spacing 1-7/8 in. centers

Hole size 9/16 in. diameter

Material 1-5/8 in. wide

Material 1/4 in. thick

Application Instructions

Parts drawings illustrate a typical use for the fitting, and in many cases other uses for the part are appropriate.

Design Data

Load ratings vary depending fittings and brackets are used with 12, *14 or 16 gauge channel. Ratings are shown for each channel material. (See page A57 for Engineering Data and Specifications).

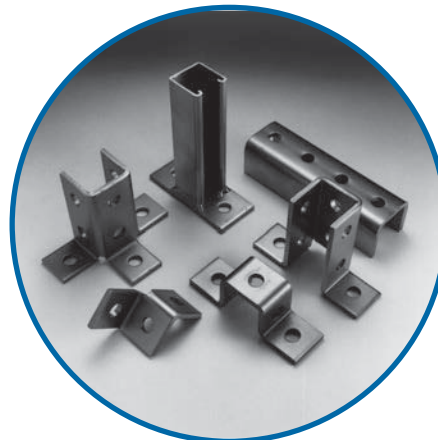

Nuts and Bolts Required

Unless otherwise noted, nuts and bolts for use with fittings and brackets should be ordered separately.

The standard bolt for the 9/16 in. hole is a 1/2 in. hex head cap screw 1 in. long. The 1 in. length may be used with all Series channel.

Design Load

For more information on design load, see page A57 Engineering Data and Specifications.

Finishes and Special Materials

Standard finishes are Hot Dipped Galvanized (HDGC) and GoldGalv® (no suffix). Fittings are also available in ElectroGalvanized (EG) and Stainless Steel 316 (SS6C). Contact your Regional Sales Office for availability and minimum quantities.

Aluminum channel

For Aluminum channel, we suggest fittings in HDG (C) or SS6 (C).

Fittings and Brackets

Flat Fittings

AB206
 AB206HDGC
 AB206EG
 AB206
 AB206SS6C
 Wt./C 35 lb.

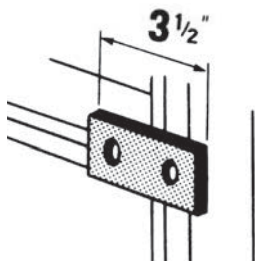

AB207
 AB207HDGC
 AB207EG
 AB207
 AB207SS6C
 Wt./C 52 lb.

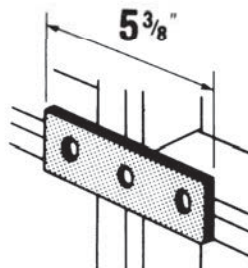

X207
 X207HDG
 X207EG
 X207
 X207SS6
 Wt./C 78 lb.

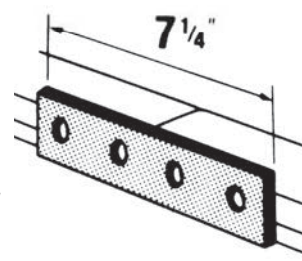

X208
 X208HDG
 X208EG
 X208
 X208SS6C
 Wt./C 88 lb.

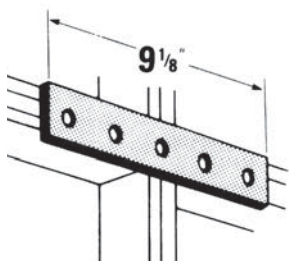

AB219
 AB219HDGC
 AB219EG
 AB219
 AB219SS6C
 Wt./C 53 lb.

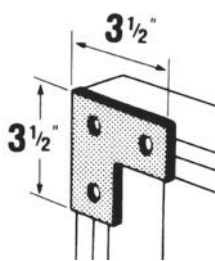

AB220
 AB220HDGC
 AB220EG
 AB220
 AB220SS6C
 Wt./C 78 lb.

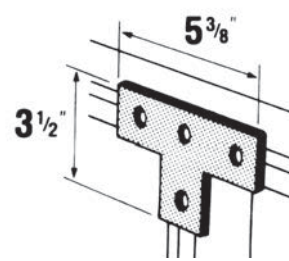

AB240
 AB240HDG
 AB240EG
 AB240
 Wt./C 69 lb.

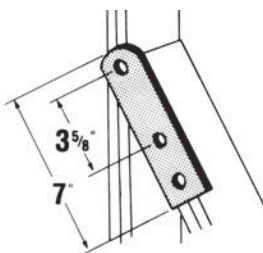

AB241

Cat. No.	Bolt Size (in.)	Wt./C lb.
AB241-1/4*	1/4	18
AB241-5/16*	5/16	18
AB241-3/8*	3/8	18
AB241-1/2*	1/2	17
AB241-5/8*	5/8	15
AB241-3/4*	3/4	14

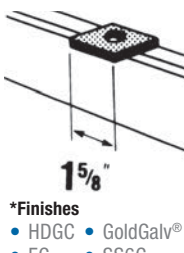

*Finishes
 • HDGC • GoldGalv®
 • EG • SS6C

AB242
 AB242HDGC
 AB242EG
 AB242
 Wt./C 9 lb.

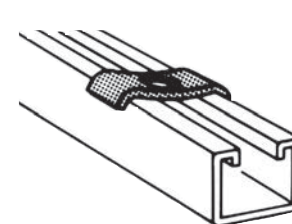

For use with either 3/8 in. or 1/2 in. hanger rod.

AB253
 AB253HDGC
 AB253EG
 AB253
 AB253SS6C
 Wt./C 97 lb.

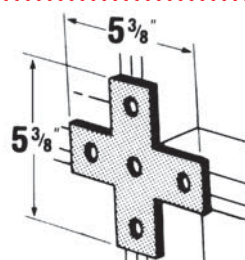

AB255
 AB255HDGC
 AB255EG
 AB255
 Wt./C 70 lb.

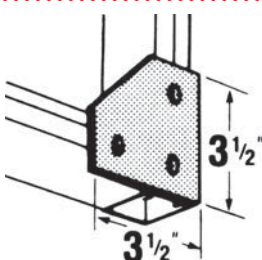

AB257
 AB257HDGC
 AB257EG
 AB257
 Wt./C 105 lb.

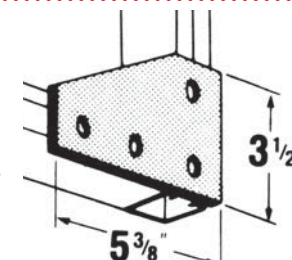

AB261
 AB261HDGC
 AB261EG
 AB261
 Wt./C 148 lb.

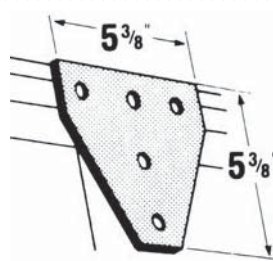

AB263
 AB263HDGC
 AB263EG
 AB263
 AB263SS6
 Wt./C 150 lb.

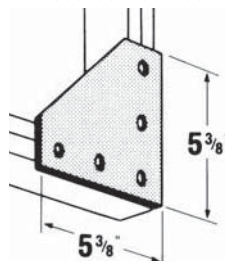

AB265
 AB265HDGC
 AB265EG
 AB265
 Wt./C 105 lb.

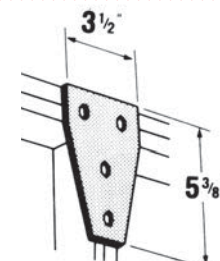

Standard Dimensions	Hole Spacing → 13/16 in. From End
	Hole Spacing → 1-7/8 in. Centers
	Hole Size → 9/16 in. Diam.
	Material → 1-5/8 in. Width
	Material → 1/4 in. Thick

Materials	HDG(C) → Hot-Dipped Galvanized
	EG(C) → ElectroGalvanized
	(No suffix) → GoldGalv®
	SS6(C) → Stainless Steel 316

Fittings and Brackets

90° Fittings

AB201
 AB201HDGC
 AB201EG
 AB201
 AB201SS6C
 Wt./C 35 lb.

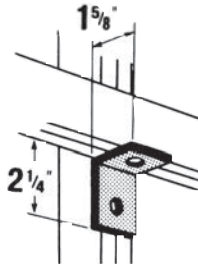

AB202
 AB202HDGC
 AB202EG
 AB202
 AB202SS6C
 Wt./C 35 lb.

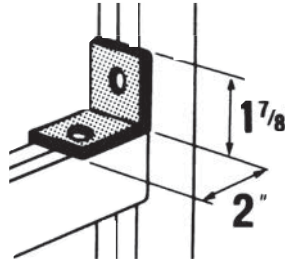

AB203
 AB203HDGC
 AB203EG
 AB203
 AB203SS6C
 Wt./C 58 lb.

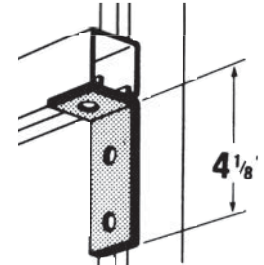

AB204
 AB204HDGC
 AB204EG
 AB204
 AB204SS6C
 Wt./C 58 lb.

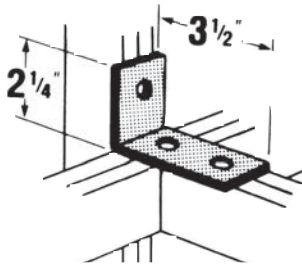

AB205
 AB205HDGC
 AB205EG
 AB205
 AB205SS6C
 Wt./C 78 lb.

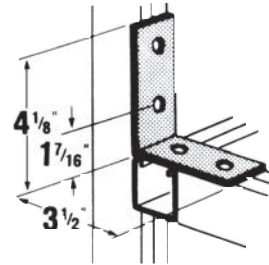

AB213
 AB213HDGC
 AB213EG
 AB213
 Wt./C 125 lb.

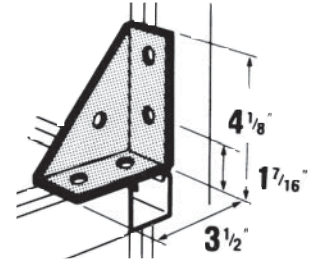

AB214
 AB214HDGC
 AB214EG
 AB214
 AB214SS6C
 Wt./C 125 lb.

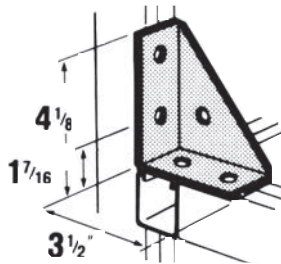

AB216
 AB216HDGC
 AB216EG
 AB216SS6C
 Wt./C 135 lb.

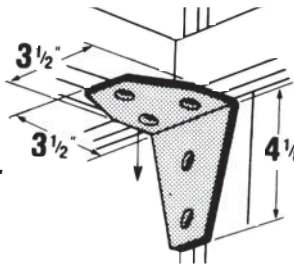

AB252

Cat. No.	A (in.)	Wt./C lb.
AB252-1*	3-7/8	61
AB252-2*	5-7/8	84
AB252-3*	7-7/8	107
AB252-4*	9-7/8	130

*Finishes
 • HDGC • EG • GoldGalv®

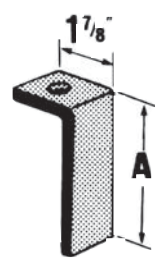

AB254R
 AB254RHDGC
 AB254REG
 AB254R
 Wt./C 105 lb.

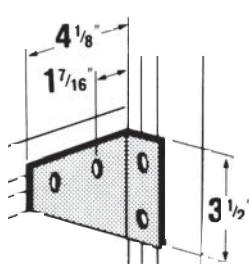

AB254L
 AB254LHDGC
 AB254LEG
 AB254L
 Wt./C 105 lb.

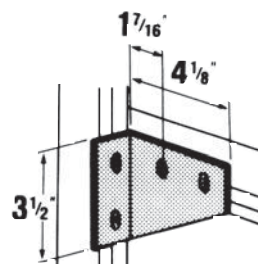

AB260R
 AB260RHDGC
 AB260REG
 AB260R
 Wt./C 58 lb.

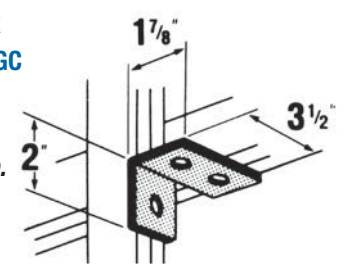

AB260L
 AB260LHDGC
 AB260LEG
 AB260L
 Wt./C 58 lb.

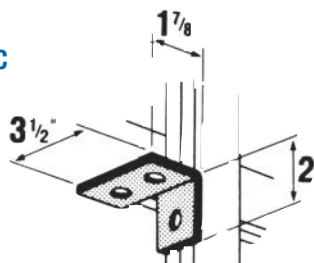

AB274
 AB274HDG
 AB274EG
 AB274
 Wt./C 70 lb.

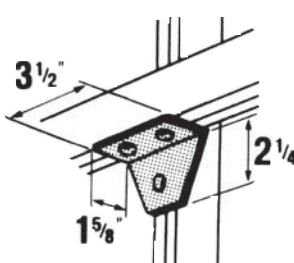

AB275
 AB275HDGC
 AB275EG
 AB275SS6C
 Wt./C 77 lb.

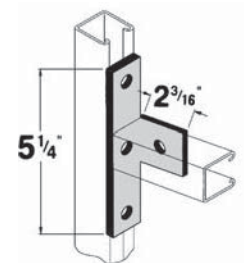

Standard Dimensions	Value
Hole Spacing	→ 13/16 in. From End
Hole Spacing	→ 1-7/8 in. Centers
Hole Size	→ 9/16 in. Diam.
Material	→ 1-5/8 in. Width
Material	→ 1/4 in. Thick

Materials	Value
HDG(C)	→ Hot-Dipped Galvanized
EG(C)	→ ElectroGalvanized
(No suffix)	→ GoldGalv®
SS6(C)	→ Stainless Steel 316

Fittings and Brackets

90° Fittings

AB284R
AB284RHDG
AB284REG
AB284L

Wt./C 230 lb.

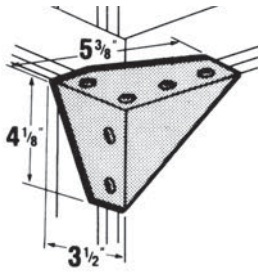

AB284L
AB284LHDG
AB284LEG
AB284L

Wt./C 230 lb.

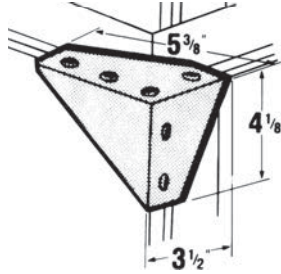

AB299
AB299HDG
AB299EG
AB299

Wt./C 40 lb.

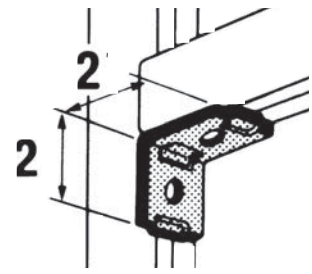

X201
X201HDG
X201EG
X201

Wt./C 65 lb.

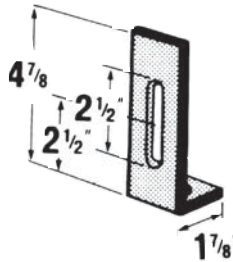

X204
X204HDG
X204EG
X204

Wt./C 1-90 lb.

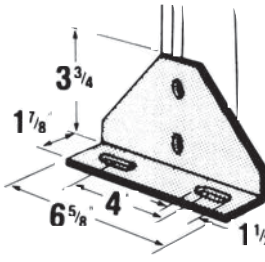

X289
X289HDG
X289EG
X289

Wt./C 105 lb.

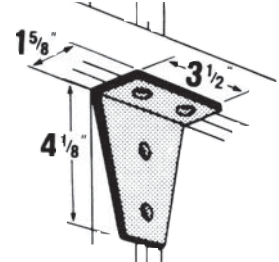

X299
X299HDG
X299EG
X299

Wt./C 38 lb.



N205
N205HDG
N205EG
N205
N205SS6C

Wt./C 74 lb.

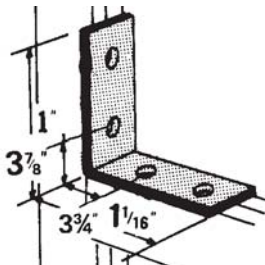

N219
N219HDG
N219EG
N219
N219SS6

Wt./C 71 lb.

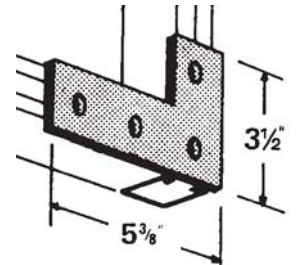

Standard Dimensions	Hole Spacing → 13/16 in. From End
	Hole Spacing → 1-7/8 in. Centers
	Hole Size → 9/16 in. Diam.
	Material → 1-5/8 in. Width
	Material → 1/4 in. Thick

Materials	HDG(C) → Hot-Dipped Galvanized
	EG(C) → Electrogalvanized
	(No suffix) → GoldGalv®
	SS6(C) → Stainless Steel 316

Fittings and Brackets

Angular Fittings

AB225

AB225HDGC
AB225EG
AB225
AB225SS6

Wt./C 58 lb.

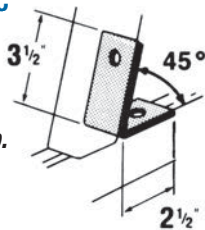

Other angles available.
Contact your Regional Sales Office.

AB226

AB226HDGC
AB226SS6

Wt./C 119 lb.

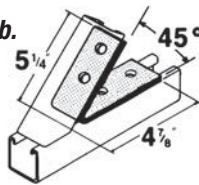

Other angles available.
Contact your Regional Sales Office.

AB227

AB227HDGC
AB227EG
AB227
AB227SS6

Wt./C 58 lb.

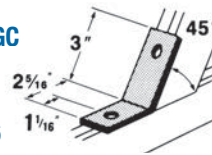

Other angles available.
Contact your Regional Sales Office.

AB228

AB228HDGC
AB228SS6C

Wt./C 69 lb.

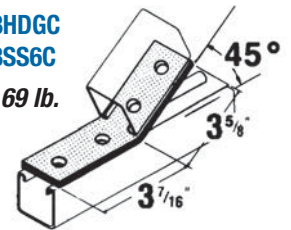

Other angles available.
Contact your Regional Sales Office.

AB231

AB231EG

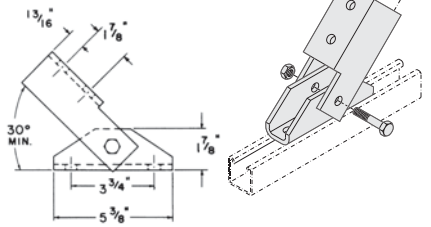

AB232

AB232EG

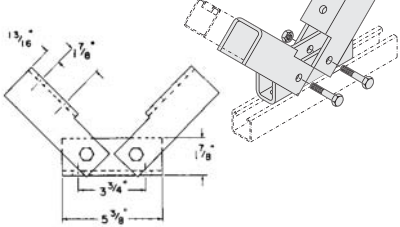

AB239

*Finishes

• HDGC • EG • GoldGalv®

Cat. No.	A (in.)	B (in.)	Wt./C lb.
AB239-1*	7-13/16	8-1/2	148
AB239-2*	13-3/4	17	255
AB239-3*	19-3/4	25-1/2	363

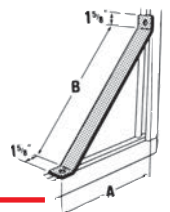

"Z" Shape Fittings

A209

A209HDGC
A209EG
A209
A209SS6

Wt./C 55 lb.

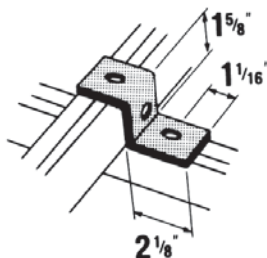

For attaching A and AR Series channel.

B209

B209HDGC
B209EG
B209

Wt./C 43 lb.

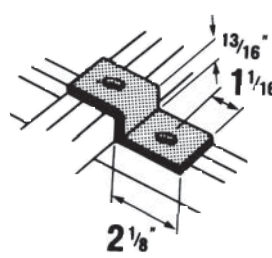

For attaching B and BR Series channel.

C209

C209

Wt./C 49 lb.

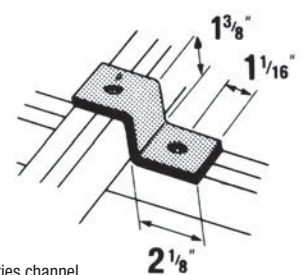

For attaching C Series channel.

D209

Wt./C 45 lb.

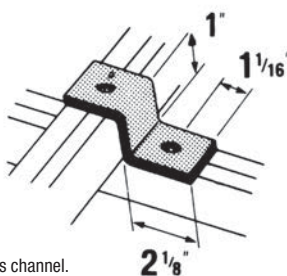

For attaching D Series channel.

CZ209

For attaching H Series
and A back to back.

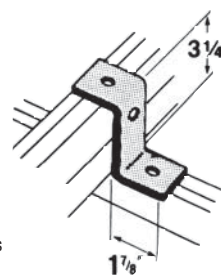

EZ209

EZ209HDGC
EZ209EG
EZ209
EZ209SS6

For attaching E Series channel.

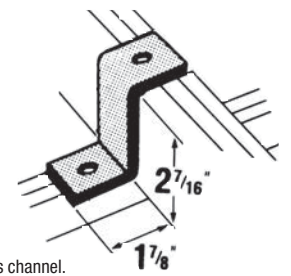

Standard Dimensions	Value
Hole Spacing	→ 13/16 in. From End
Hole Spacing	→ 1-7/8 in. Centers
Hole Size	→ 9/16 in. Diam.
Material	→ 1-5/8 in. Width
Material	→ 1/4 in. Thick

Materials	Value
HDG(C)	→ Hot-Dipped Galvanized
EG(C)	→ ElectroGalvanized
(No suffix)	→ GoldGalv®
SS6(C)	→ Stainless Steel 316

Fittings and Brackets

“U” Shape Fittings

A208

A208HDGC
A208EG
A208
A208SS6C

Wt./C 275 lb.

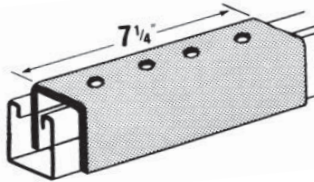

Does not include stud nut or bolts.
For A and AR Series channel.

A213 Inside Joiner

Wt./C 40 lb.

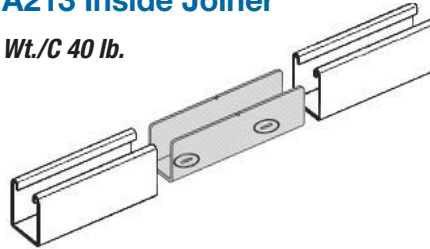

For A1200 Series.
Available only in GoldGalv® finish.

A210

A210HDGC
A210EG
A210
A210SS6C

Wt./C 88 lb.

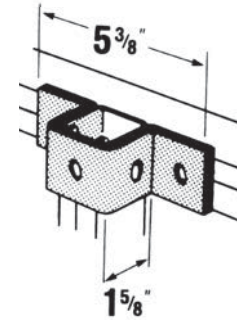

For attaching A and AR Series channel.

A211

A211HDGC
A211EG
A211

Wt./C 128 lb.

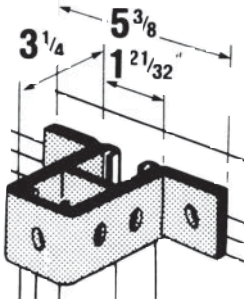

For attaching A and AR Series double channel, and H Series.

AN211

AN211HDGC
AN211EG
AN211

Wt./C 181 lb.

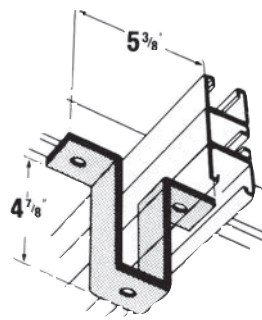

A212

A212HDGC
A212EG
A212
A212SS6

Wt./C 113 lb.

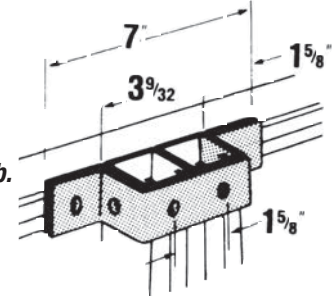

B210

B210HDGC
B210EG
B210
B210SS6

Wt./C 65 lb.

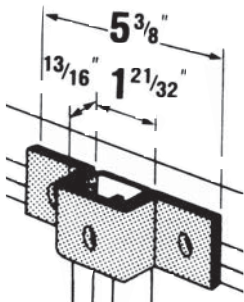

For attaching B and BR Series.

C210

C210HDGC
C210EG
C210

Wt./C 77 lb.

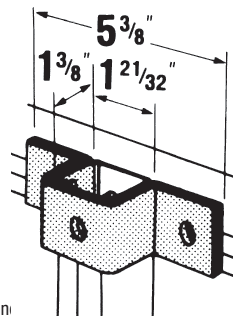

For attaching C Series channel.

D210

D210HDGC
D210EG
D210
D210SS6

Wt./C 71 lb.

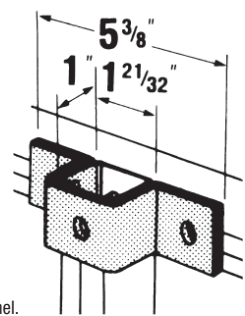

For attaching D Series channel.

E210

E210HDGC
E210EG
E210

Wt./C 112 lb.

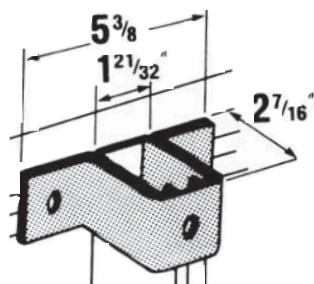

For attaching E Series channel.

AB245

AB245HDGC
AB245EG
AB245

Wt./C 70 lb.

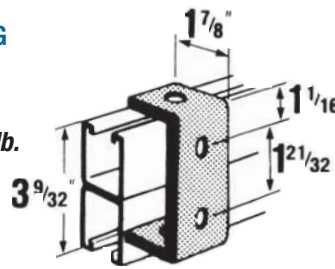

For attaching A and AR Series double channel.

AB288

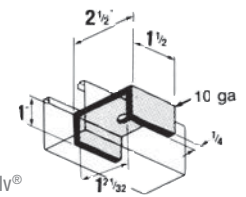

*Finishes
• HDGC • EG • GoldGalv®

Cat. No.	Bolt Size (in.)	Wt./C lb.
AB288-3/8*	3/8	37
AB288-1/2*	1/2	
AB288-5/8*	5/8	

Standard Dimensions	Value
Hole Spacing	→ 13/16 in. From End
Hole Spacing	→ 1-7/8 in. Centers
Hole Size	→ 9/16 in. Diam.
Material	→ 1-5/8 in. Width
Material	→ 1/4 in. Thick

Materials	Value
HDG(C)	→ Hot-Dipped Galvanized
EG(C)	→ Electrogalvanized
(No suffix)	→ GoldGalv®
SS6(C)	→ Stainless Steel 316

Fittings and Brackets

Wing Fittings

AW204

AW204HDG
AW204EG
AW204

Wt./C 76 lb.

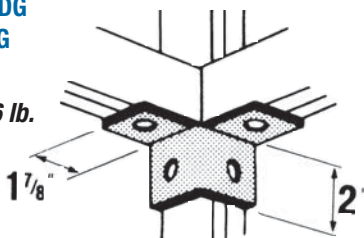

AW214

AW214HDG
AW214EG
AW214

Wt./C 115 lb.

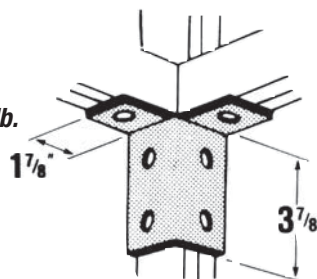

A217

AW217HDG
A217EG
A217

Wt./C 155 lb.

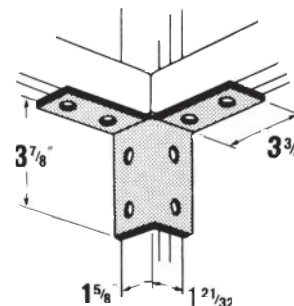

AW205L

AW205LHDG
AW205LEG
AW205L

Wt./C 59 lb.

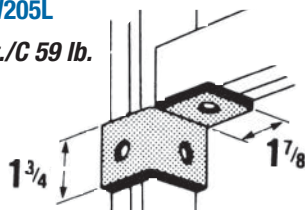

AW205R

AW205REG
AW205R

Wt./C 59 lb.

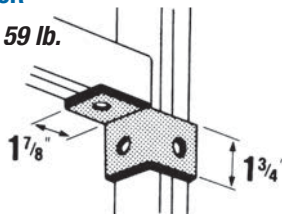

AW215L

AW215LHDG
AW215LEG
AW215L

Wt./C 98 lb.

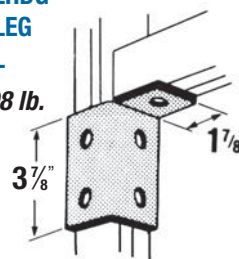

AW215R

AW215RHDG
AW215REG
AW215R

Wt./C 98 lb.

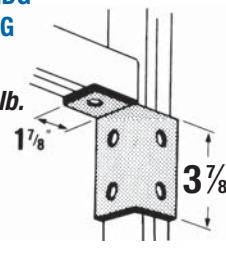

AW220

AW220HDGC
AW220EG
AW220

Wt./C 90 lb.

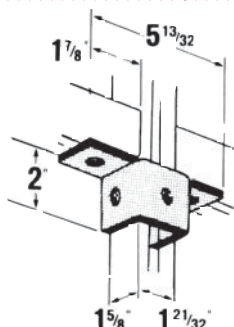

AW224

AW224HDGC
AW224EG
AW224

Wt./C 147 lb.

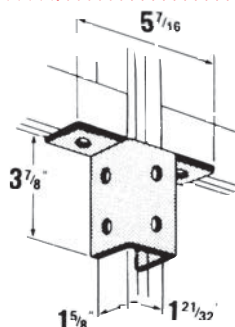

AW219

AW219HDGC
AW219EG
AW219

Wt./C 187 lb.

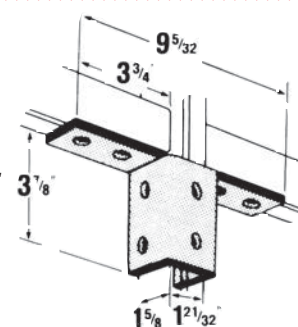

AW226

AW226HDG
AW226

Wt./C 113 lb.

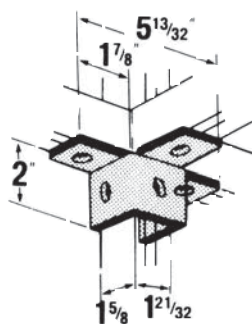

A218

A218HDG
A218EG
A218

Wt./C 177 lb.

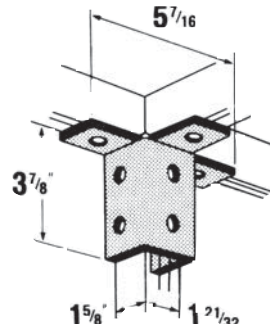

AW228

AW228HDG
AW228EG
AW228

Wt./C 230 lb.

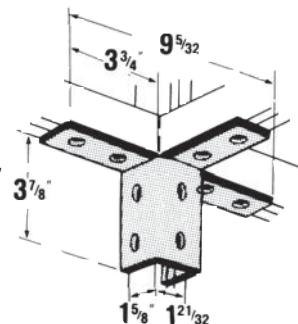

Standard Dimensions	Hole Spacing	→ 13/16 in. From End
	Hole Spacing	→ 1-7/8 in. Centers
	Hole Size	→ 9/16 in. Diam.
	Material	→ 1-5/8 in. Width
	Material	→ 1/4 in. Thick

Materials	HDG(C)	→ Hot-Dipped Galvanized
	EG(C)	→ Electrogalvanized
	(No suffix)	→ GoldGal®
	SS6(C)	→ Stainless Steel 316

Fittings and Brackets

Brackets

S202

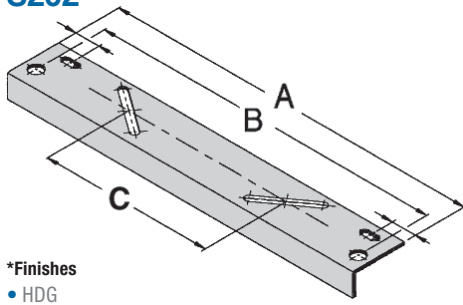

*Finishes
• HDG

Cat. No.	A (in.)	B (in.)	C (in.)	Wt./C lb.
S202-6*	6	5	—	75
S202-9*	9	8	2	100
S202-15*	15	14	18	175
S202-21*	21	20	14	250
S202-27*	27	26	20	325
S202-33*	33	32	26	400

S203

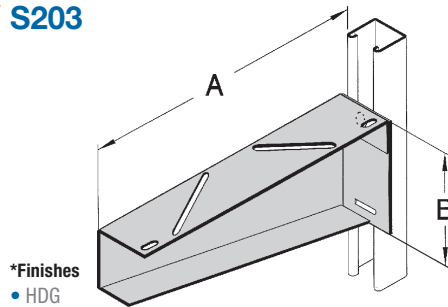

*Finishes
• HDG

Cat. No.	A (in.)	B (in.)	Design Load/lb.	Wt./C lb.
S203-8*	8-1/2	4-1/16	1200	180
S203-14*	14-1/2	5-3/8		325
S203-20*	20-1/2	6-11/16		525
S203-26*	26-1/2	8		675
S203-32*	32-1/2	8		840
S203-38*	38-1/2	8		1050

S249

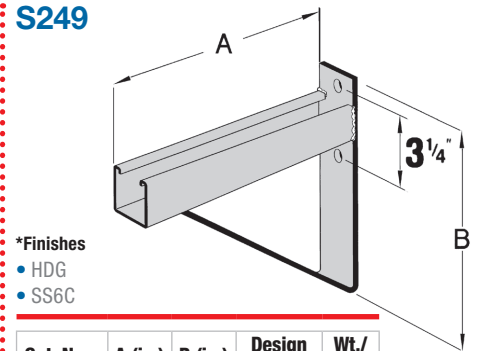

*Finishes
• HDG
• SS6C

Cat. No.	A (in.)	B (in.)	Design Load/lb.	Wt./C lb.
S249-8*	8-1/2	8	1500	320
S249-14*	14-1/2	9		520
S249-20*	20-1/2	9		660
S249-26*	26-1/2	11-1/2		870
S249-32*	32-1/2	11-1/2		1030
S249-38*	38-1/2	11-1/2		1230

S250

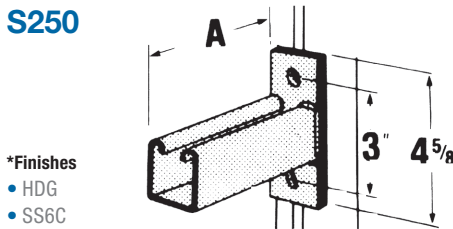

*Finishes
• HDG
• SS6C

Cat. No.	A (in.)	Design Load/lb.	Wt./C lb.
S250-6*	6	1500	150
S250-8*	8-1/2	1500	150
S250-12*	12	800	250
S250-14*	14-1/2	800	250
S250-18*	18	550	350
S250-20*	20-1/2	550	350
S250-24*	24	400	450
S250-26*	26-1/2	400	450

May be installed inverted with no change in load ratings.

S251

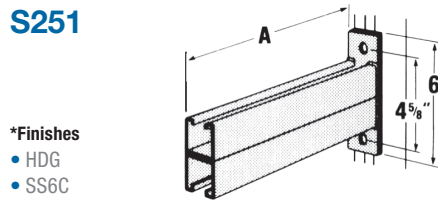

*Finishes
• HDG
• SS6C

Cat. No.	A (in.)	Design Load/lb.	Wt./C lb.
S251-12*	12	1650	514
S251-14*	14-1/2	1650	514
S251-18*	18	1050	714
S251-20*	20-1/2	1050	714
S251-24*	24	800	914
S251-26*	26-1/2	800	914
S251-30*	30	650	1114
S251-32*	32-1/2	650	1114
S251-36*	36	500	1314
S251-38*	38-1/2	500	1314

S256

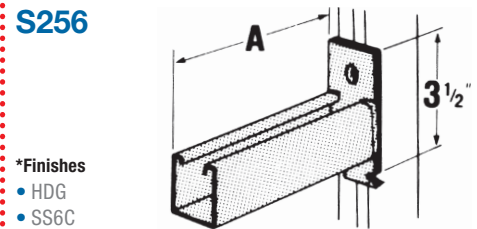

*Finishes
• HDG
• SS6C

Cat. No.	A (in.)	Design Load/lb.	Wt./C lb.
S256-6*	6	1000	151
S256-8*	8-1/2	1000	151
S256-12*	12	500	251
S256-14*	14-1/2	500	251
S256-18*	18	300	351
S256-20*	20-1/2	300	351
S256-24*	24	250	451
S256-26*	26-1/2	250	451

When installed in inverted position reduce load rating 40%.

S247

S247HDG
S247
S247SS6

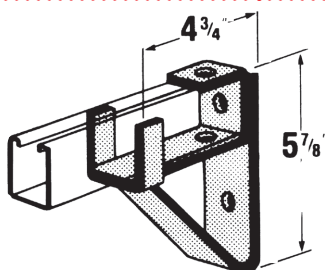

Design Moment
(channel upright as shown)
When Supported By

A-1200 5250 inch lb.

A-1400 3650 inch lb.

Applies to fitting only, not to the arm.

S248

S248HDGC
S248

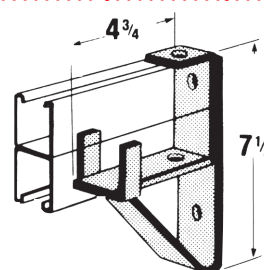

Design Moment
(channel upright as shown)
When Supported By

A-1202 10 800 inch lb.

A-1402 7 550 inch lb.

Applies to fitting only, not to the arm.

Standard Dimensions	Value
Hole Spacing	→ 13/16 in. From End
Hole Spacing	→ 1-7/8 in. Centers
Hole Size	→ 9/16 in. Diam.
Material	→ 1-5/8 in. Width
Material	→ 1/4 in. Thick

Materials	Value
HDG(C)	→ Hot-Dipped Galvanized
EG(C)	→ ElectroGalvanized
(No suffix)	→ GoldGalv®
SS6(C)	→ Stainless Steel 316

Fittings and Brackets

Brackets

S204
S204HDGC
S204

Wt./C 174 lb.

Design Uniform Load/lb.	
A-1200	750
A-1400	500

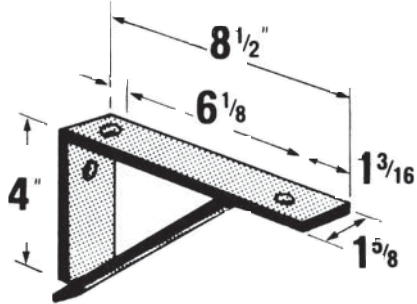

S205
S205HDGC
S205

Wt./C 264 lb.

Design Uniform Load/lb.	
A-1200	750
A-1400	500

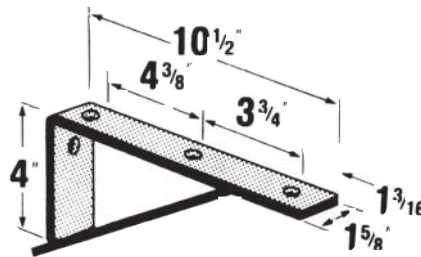

S217
S217HDG
S217
S217SS6

Wt./C 264 lb.

Design Uniform Load/lb.	
A-1200	750
A-1400	650

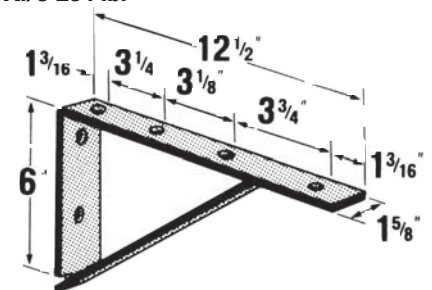

S218
S218HDG
S218

Wt./C 295 lb.

Design Uniform Load/lb.	
A-1200	750
A-1400	650

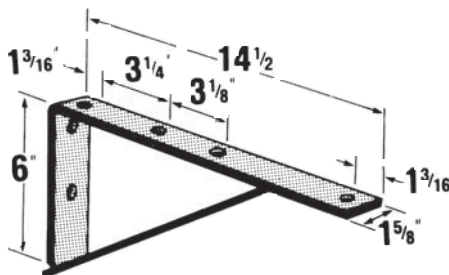

S222
S222HDG
S222

Wt./C 385 lb.

Design Uniform Load/lb.	
A-1200	1000
A-1400	750

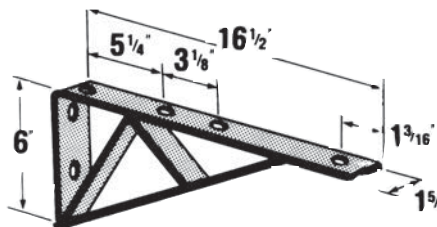

S226
S226HDG
S226

Wt./C 421 lb.

Design Uniform Load/lb.	
A-1200	1000
A-1400	750

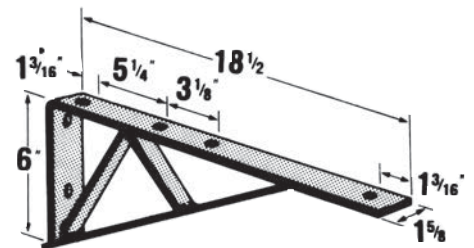

Fittings and Brackets

Post Bases

AP232

AP232HDGC
AP232EG
AP232

Wt./C 384 lb.

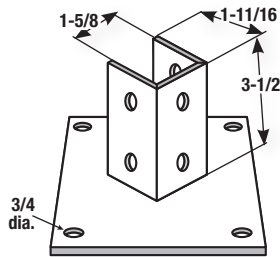

AP235

AP235HDGC
AP235EG
AP235

Wt./C 400 lb.

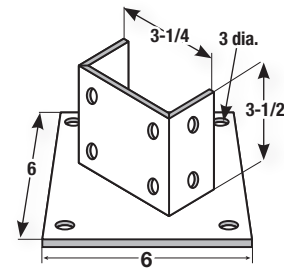

AP232SQ

AP232SQHDGC
AP232SQEG
AP232SQSS6

Wt./C 384 lb.

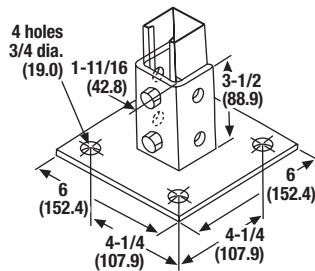

AP235SQ

AP235SQHDGC
AP235SQEG
AP235SQ
AP235SQSS6

Wt./C 400 lb.

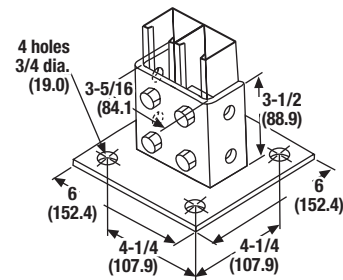

AP232FL

AP232FLHDG
AP232FLEG
AP232FL

Wt./C 272 lb.

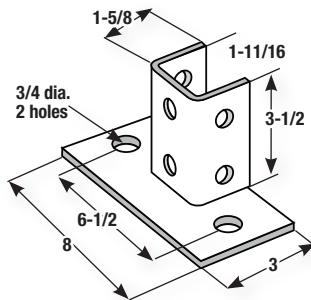

AP235FL

AP235FLHDGC
AP235FLEG
AP235FL

Wt./C 360 lb.

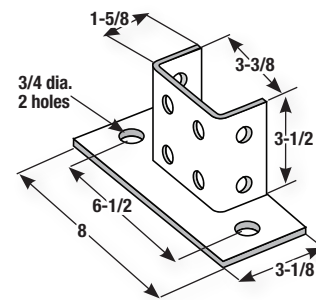

AN270

*Finishes

- HDG
- EG

Cat. No.	A	B	Wt./C lb.
AN270-1*	2-3/8	6	113
AN270-2*	4-3/8	8	151
AN270-3*	6-3/8	10	199
AN270-4*	8-3/8	12	246
AN270-5*	10-3/8	14	293

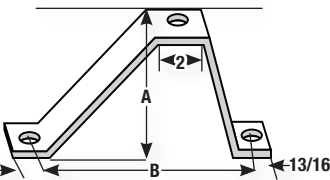

TS272 Track Support

TS272HDG

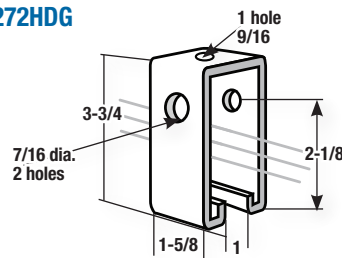

Requires 3/8 in. x 2-1/2 in. bolt and nut (not included)
Design load: 1000 lb.
Wt./C 104 lb.

TS273 Track Support

TS273HDG

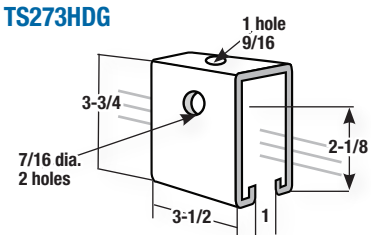

For use over channel splice
Requires 3/8 in. x 2-1/2 in. bolt and nut (not included)
Design load: 2000 lb.
Wt./C 228 lb.

Fittings and Brackets

Special Application Fittings and Brackets

TR292

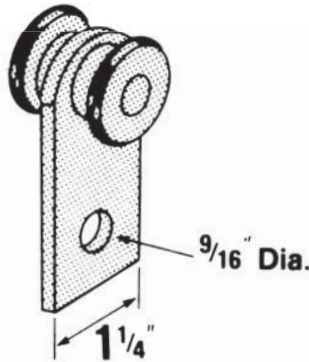

Can be used for Series A, E and H channels only.

Standard finish is Electrogalvanized.

Frictionless needle bearings.

Design load: 500 lb.

Safety factor of 5.

Wt./C 59 lb.

TR294

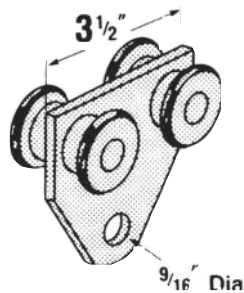

Can be used for Series A, E and H channels only.

Standard finish is Electrogalvanized.

Frictionless needle bearings.

Design load: 1000 lb.

Safety factor of 5.

Wt./C 106 lb.

C728 Pipe Roller (Pair)

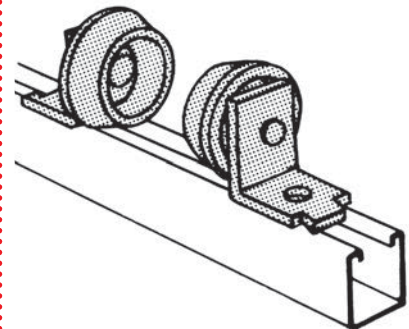

Cast aluminum rollers, steel brackets. Designed for standard saddles. Order separately for each pair of rollers: two 1/2 in. x 5/16 in. hex head cap screws and two 1/2 in. channel nuts. Space to suit O.D. of pipe and wrapping.

Design Load: 2350 lb.

Wt./C : 300 lb.

Adjustable Universal Support

Support building services and access equipment on flat roofs and flat surfaces



The T&B Adjustable Universal Support (AUS) provides an easy method for supporting pipes, conduit and equipment on flat roofs, below raised floors and even on level ground applications. The AUS reduces installation time compared to other support solutions such as wooden blocks, cement blocks, straps and clips. These labor intensive solutions also increase the danger of roof membrane penetration.

The AUS system also allows for tool free adjustment of the pedestal height from 6 to 9 inches with a twist of the wrist. This ensures that the supported objects or pipes are uniformly supported and no high stress supports are carrying a disproportionate load in a single location.

Cat. No.	Description	Qty.
AUS14-96	Ajustable Universal Support (Base only)	1
AUS-RISER-KIT	Riser Kit	
A1200HS100PG	14 in. strut	1
H104-1/2X10EGC	12 in. threaded rod	2
E145-1/2EGC	Nut	8
E147-1/2EGC	Washer	8
E148-1/2EGC	Lock washer	4
AUS-STRUT-KIT	Bolt Kit	
A1200HS100PG	14 in. strut	1
E142-1/2X200EGC	Bolt	2
E145-1/2EGC	Nut	2
E147-1/2EGC	Washer	4
E148-1/2EGC	Lock washer	2
AUS125PCSS6	4-1/2 in. stainless steel 316 strap (to restrain 1-1/4 in. pipe)	2
AUS150PCSS6	5 in. strap (to restrain 1-1/2 in. pipe)	2
AUS200PCSS6	6 in. strap (to restrain 2 in. pipe)	2

