



Sanitary Fittings & Tubing

Specifications

- Sanitary tubing and fittings are produced to 3-A Sanitary Standards
- Stainless steel sanitary tubing dimensions and materials conform to ASTM A269/A270
- Stainless steel plate flanges made from ASTM A240 (Plate) or cast in conformance with ASTM A351
- Independent lab verification that fittings meet applicable chemical & physical properties
- Material test reports available
- Manufacturing facility is ISO 9001:2008
- SCI logo, heat number & country of origin marked on every fitting



SCI ProPak™ System

Fig. S77L2S4 & S77L2S6 – 90° Tube Bend (Long Radius)

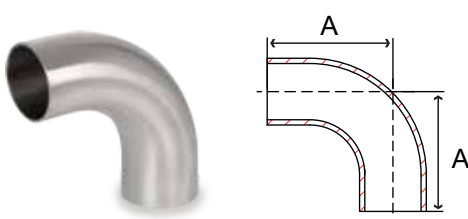

Tube OD in	Part Number		A in	Packing		Weight lb
	304	316/L		Inner	Master	
1	S77L2S4010	S77L2S6010	2.06	36	72	0.1
1-1/2	S77L2S4014	S77L2S6014	2.94	10	20	0.4
2	S77L2S4020	S77L2S6020	4.06	4	8	0.7
2-1/2	S77L2S4024	S77L2S6024	5.19	-	5	1.2
3	S77L2S4030	S77L2S6030	6.31	-	3	1.8
4	S77L2S4040	S77L2S6040	8.31	-	10	4.2
6	S77L2S4060	S77L2S6060	12.46	-	2	5.8

Fig. S772WCL4 & S772WCL6 – 90° Tube Bend (Short Radius)

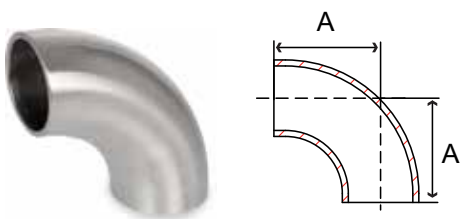

Tube OD in	Part Number		A in	Packing		Weight lb
	304	316/L		Inner	Master	
1/2	-	S772WCL6004	1.13	200	800	0.1
3/4	-	S772WCL6006	1.13	100	400	0.2
1	S772WCL4010	S772WCL6010	1.50	50	100	0.3
1-1/2	S772WCL4014	S772WCL6014	2.25	20	40	0.4
2	S772WCL4020	S772WCL6020	3.00	6	12	0.7
2-1/2	S772WCL4024	S772WCL6024	3.75	-	12	1.1
3	S772WCL4030	S772WCL6030	4.50	-	4	1.6
4	S772WCL4040	S772WCL6040	6.00	-	18	3.5
6	S772WCL4060	S772WCL6060	9.00	-	3	8.2

Fig. S77L2KS4 & S77L2KS6 – 45° Tube Bend (Long Radius)

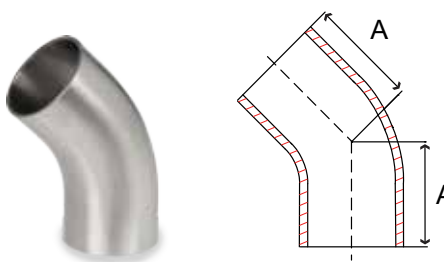

Tube OD in	Part Number		A in	Packing		Weight lb
	304	316/L		Inner	Master	
1/2	-	S77L2KS6004	2.25	20	40	0.1
3/4	-	S77L2KS6006	2.25	15	30	0.1
1	S77L2KS4010	S77L2KS6010	1.18	60	120	0.1
1-1/2	S77L2KS4014	S77L2KS6014	1.62	20	40	0.2
2	S77L2KS4020	S77L2KS6020	2.31	6	12	0.5
2-1/2	S77L2KS4024	S77L2KS6024	3.00	4	8	0.8
3	S77L2KS4030	S77L2KS6030	3.68	2	4	1.2
4	S77L2KS4040	S77L2KS6040	4.81	-	18	2.5
6	-	S77L2KS6060	6.22	-	1	6.9

Fig. S772WK4 & S772WK6 – 45° Tube Bend (Short Radius)

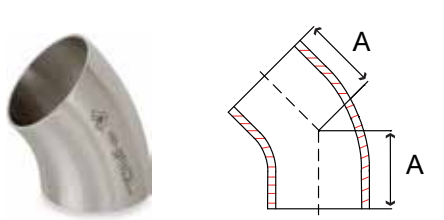

Tube OD in	Part Number		A in	Packing		Weight lb
	304	316/L		Inner	Master	
1	S772WK4010	S772WK6010	0.63	60	240	0.1
1-1/2	S772WK4014	S772WK6014	0.94	40	80	0.2
2	S772WK4020	S772WK6020	1.25	12	24	0.3
2-1/2	S772WK4024	S772WK6024	1.56	6	12	0.4
3	S772WK4030	S772WK6030	1.88	-	12	0.6
4	S772WK4040	S772WK6040	2.50	-	4	1.4
6	S772WK4060	S772WK6060	3.75	-	1	4.1

Fig. S77L7W4 & S77L7W6 – Long Tee

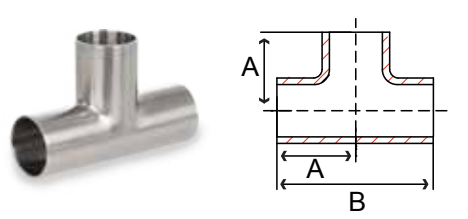

Tube OD in	Part Number		A in	B in	Packing		Weight lb
	304	316/L			Inner	Master	
1/2	-	S77L7W6004	1.87	3.75	40	160	0.1
3/4	-	S77L7W6006	2.00	4.00	15	60	0.2
1	S77L7W4010	S77L7W6010	1.87	3.75	12	48	0.3
1-1/2	S77L7W4014	S77L7W6014	2.25	4.50	6	12	0.5
2	S77L7W4020	S77L7W6020	3.00	6.00	2	8	0.9
2-1/2	S77L7W4024	S77L7W6024	3.00	6.00	-	8	1.2
3	S77L7W4030	S77L7W6030	3.25	6.50	-	6	1.5
4	S77L7W4040	S77L7W6040	3.87	7.75	-	12	2.7
6	S77L7W4060	S77L7W6060	5.63	11.25	-	4	8.4

Dimensions may change at any time due to continuous product development.

SANITARY

Fig. S777RW4 & S777RW6 Reducing Tee

Tube OD in	Part Number		A in	B in	Packing		Weight lb
	304	316/L			Inner	Master	
3/4 x 1/2	-	S777RW6006004	2.13	2.13	10	40	0.1
1 x 1/2	-	S777RW6010004	2.13	2.13	5	10	0.1
1 x 3/4	-	S777RW6010006	2.13	2.13	5	10	0.2
1-1/2 x 1/2	-	S777RW6014004	2.25	2.37	-	15	0.3
1-1/2 x 3/4	-	S777RW6014006	2.25	2.37	-	15	0.3
1-1/2 x 1	S777RW4014010	S777RW6014010	1.65	1.37	-	15	0.3
2 x 1/2	-	S777RW6020004	3.00	2.38	-	10	0.6
2 x 3/4	-	S777RW6020006	3.00	2.38	-	10	0.6
2 x 1	S777RW4020010	S777RW6020010	2.06	1.63	-	8	0.6
2 x 1-1/2	S777RW4020014	S777RW6020014	2.06	1.91	-	8	0.6
2-1/2 x 1-1/2	S777RW4024014	S777RW6024014	2.34	2.16	-	8	0.6
2-1/2 x 2	S777RW4024020	S777RW6024020	2.34	2.31	-	8	0.7
3 x 1-1/2	S777RW4030014	S777RW6030014	2.59	2.41	-	6	1.0
3 x 2	S777RW4030020	S777RW6030020	2.59	2.56	-	6	1.0
3 x 2-1/2	S777RW4030024	S777RW6030024	2.59	2.59	-	6	1.0
4 x 1-1/2	S777RW4040014	S777RW6040014	3.44	2.91	-	12	2.4
4 x 2	S777RW4040020	S777RW6040020	3.44	3.06	-	12	2.4
4 x 2-1/2	S777RW4040024	S777RW6040024	3.44	3.09	-	12	2.4
4 x 3	S777RW4040030	S777RW6040030	3.44	3.09	-	12	2.4
6 x 3	S777RW4060030	S777RW6060030	6.30	4.87	-	4	4.8
6 x 4	S777RW4060040	S777RW6060040	6.30	4.87	-	4	4.8

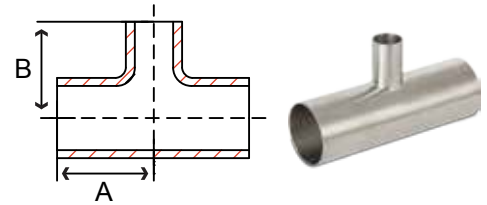

Fig. S77L31W4 & S77L31W6 – Concentric Reducer

Tube OD in	Part Number		A in	Packing		Weight lb
	304	316/L		Inner	Master	
3/4 x 1/2	-	S77L31W6006004	1.00	50	200	0.1
1 x 3/4	-	S77L31W6010006	2.00	30	120	0.2
1-1/2 x 1	S77L31W4014010	S77L31W6014010	2.00	24	96	0.2
2 x 1	S77L31W4020010	S77L31W6020010	4.00	16	32	0.2
2 x 1-1/2	S77L31W4020014	S77L31W6020014	2.00	30	60	0.3
2-1/2 x 1-1/2	S77L31W4024014	S77L31W6024014	4.00	5	20	0.3
2-1/2 x 2	S77L31W4024020	S77L31W6024020	2.00	16	32	0.2
3 x 1	S77L31W4030010	S77L31W4030010	8.00	-	12	0.9
3 x 1-1/2	S77L31W4030014	S77L31W6030014	6.00	4	8	0.8
3 x 2	S77L31W4030020	S77L31W6030020	4.00	6	12	0.6
3 x 2-1/2	S77L31W4030024	S77L31W6030024	2.00	12	24	0.3
4 x 1-1/2	S77L31W4040014	S77L31W6040014	10.00	-	12	1.9
4 x 2	S77L31W4040020	S77L31W6040020	8.00	2	4	1.4
4 x 2-1/2	S77L31W4040024	S77L31W6040024	6.00	2	4	1.1
4 x 3	S77L31W4040030	S77L31W6040030	4.00	3	6	0.8
6 x 3	S77L31W4060030	S77L31W6060030	5.50	-	12	1.6
6 x 4	S77L31W4060040	S77L31W6060040	5.50	-	12	1.2

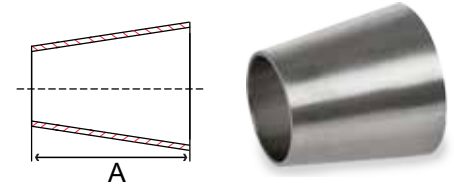
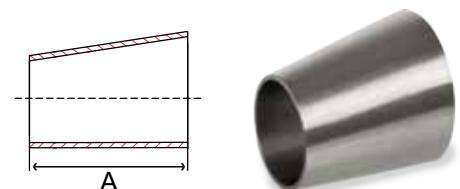

Fig. S77L32W4 & S77L32W6 – Eccentric Reducer

Tube OD in	Part Number		A in	Packing		Weight lb
	304	316/L		Inner	Master	
1-1/2 x 1	S77L32W4014010	S77L32W6014010	2.50	24	96	0.1
2 x 1	S77L32W4020010	S77L32W6020010	2.00	9	36	0.2
2 x 1-1/2	S77L32W4020014	S77L32W6020014	2.00	10	40	0.2
2-1/2 x 1-1/2	S77L32W4024014	S77L32W6024014	4.00	5	20	0.4
2-1/2 x 2	S77L32W4024020	S77L32W6024020	2.00	5	20	0.3
3 x 1	-	S77L32W6030010	8.00	4	16	0.9
3 x 1-1/2	S77L32W4030014	S77L32W6030014	6.00	2	8	0.8
3 x 2	S77L32W4030020	S77L32W6030020	4.00	3	12	0.6
3 x 2-1/2	S77L32W4030024	S77L32W6030024	2.00	4	16	0.4
4 x 1-1/2	-	S77L32W6040014	10.00	2	4	1.8
4 x 2	S77L32W4040020	S77L32W6040020	8.00	2	4	1.5
4 x 2-1/2	S77L32W4040024	S77L32W6040024	6.00	-	6	1.3
4 x 3	S77L32W4040030	S77L32W6040030	4.00	3	6	0.9
6 x 3	-	S77L32W6060030	5.50	-	1	1.6
6 x 4	-	S77L32W6060040	5.50	-	1	1.4



Dimensions may change at any time due to continuous product development.

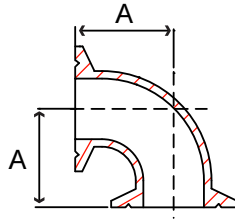

Fig. S772CMP4 & S772CMP6 – 90° Elbow

Tube OD in	Part Number		A in	Packing		Weight lb
	304	316/L		Inner	Master	
1/2	-	S772CMP6004	1.62	25	100	0.2
3/4	-	S772CMP6006	1.62	25	100	0.2
1	S772CMP4010	S772CMP6010	2.00	12	24	0.3
1-1/2	S772CMP4014	S772CMP6014	2.75	10	20	0.4
2	S772CMP4020	S772CMP6020	3.50	4	8	0.8
2-1/2	S772CMP4024	S772CMP6024	4.25	2	4	1.0
3	S772CMP4030	S772CMP6030	5.00	-	4	2.0
4	S772CMP4040	S772CMP6040	6.62	-	8	3.6
6	S772CMP4060	S772CMP6060	9.86	-	2	3.4

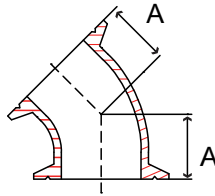

Fig. S772KMP4 & S772KMP6 – 45° Elbow

Tube OD in	Part Number		A in	Packing		Weight lb
	304	316/L		Inner	Master	
1/2	-	S772KMP6004	0.75	10	40	0.2
3/4	-	S772KMP6006	0.97	10	40	0.2
1	S772KMP4010	S772KMP6010	1.12	15	30	0.2
1-1/2	S772KMP4014	S772KMP6014	1.43	-	30	0.3
2	S772KMP4020	S772KMP6020	1.75	-	20	0.5
2-1/2	S772KMP4024	S772KMP6024	2.06	3	6	0.6
3	S772KMP4030	S772KMP6030	2.37	-	6	1.2
4	S772KMP4040	S772KMP6040	3.12	-	12	2.2

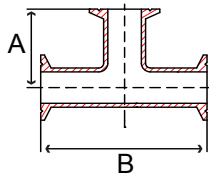

Fig. S777MP4 & S777MP6 – Tee

Tube OD in	Part Number		A in	B in	Packing		Weight lb
	304	316/L			Inner	Master	
1/2	-	S777MP6004	2.37	4.75	20	40	0.3
3/4	-	S777MP6006	2.50	5.00	20	40	0.3
1	S777MP4010	S777MP6010	2.37	4.75	8	16	0.3
1-1/2	S777MP4014	S777MP6014	2.75	5.50	6	12	0.4
2	S777MP4020	S777MP6020	3.50	7.00	-	6	0.8
2-1/2	S777MP4024	S777MP6024	3.50	7.00	-	5	1.0
3	S777MP4030	S777MP6030	3.75	7.50	-	2	2.0
4	S777MP4040	S777MP6040	4.50	9.00	-	9	3.6
6	S777MP4060	S777MP6060	6.50	13.00	-	4	6.9

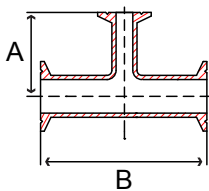

Fig. S777RMP4 & S777RMP6 – Reducing Tee

Tube OD in	Part Number		A in	B in	Packing		Weight lb
	304	316/L			Inner	Master	
1 x 1/2	-	S777RMP6010004	2.62	5.25	5	10	0.5
1 x 3/4	-	S777RMP6010006	2.62	5.25	5	10	0.5
1-1/2 x 1	S777RMP4014010	S777RMP6014010	2.87	5.75	6	12	0.7
2 x 1	S777RMP4020010	S777RMP6020010	2.12	5.12	3	6	1.1
2 x 1-1/2	S777RMP4020014	S777RMP6020014	2.40	5.12	4	8	1.1
2-1/2 x 1-1/2	S777RMP4024014	S777RMP6024014	3.25	7.00	2	4	1.3
2-1/2 x 2	S777RMP4024020	S777RMP6024020	2.81	5.69	2	4	1.4
3 x 1-1/2	S777RMP4030014	S777RMP6030014	2.90	6.19	-	2	1.7
3 x 2	S777RMP4030020	S777RMP6030020	3.06	6.19	-	2	1.7
3 x 2-1/2	S777RMP4030024	S777RMP6030024	3.09	6.19	-	2	1.8
4 x 1-1/2	S777RMP4040014	S777RMP6040014	3.40	8.12	-	9	3.2
4 x 2	S777RMP4040020	S777RMP6040020	3.56	8.12	-	9	3.2
4 x 2-1/2	S777RMP4040024	S777RMP6040024	3.59	8.12	-	9	3.5
4 x 3	S777RMP4040030	S777RMP6040030	3.66	8.12	-	9	3.5

Dimensions may change at any time due to continuous product development.

SANITARY

Fig. S773114MP4 & S773114MP6 – Concentric Reducer

Tube OD in	Part Number		A in	Packing		Weight lb
	304	316/L		Inner	Master	
1 x 1/2	-	S773114MP610004	2.00	12	48	0.3
1 x 3/4	-	S773114MP610006	2.00	12	48	0.3
1-1/2 x 1	S773114MP414010	S773114MP614010	3.00	16	32	0.3
2 x 1	S773114MP420010	S773114MP620010	5.00	6	12	0.5
2 x 1-1/2	S773114MP420014	S773114MP620014	3.00	12	24	0.4
2-1/2 x 2	S773114MP424020	S773114MP624020	5.00	6	12	0.6
3 x 1-1/2	S773114MP430014	S773114MP630014	7.00	2	4	1.2
3 x 2	S773114MP430020	S773114MP630020	5.00	2	4	1.0
3 x 2-1/2	S773114MP430024	S773114MP630024	3.00	3	6	0.7
4 x 2	S773114MP440020	S773114MP640020	9.12	-	10	2.1
4 x 2-1/2	S773114MP440024	S773114MP640024	7.12	-	9	1.9
4 x 3	S773114MP440030	S773114MP640030	5.12	-	18	1.7

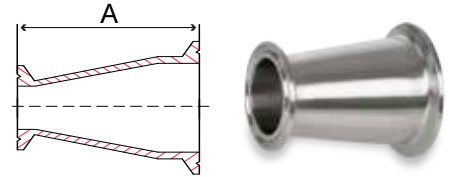

Fig. S773214MP4 & S773214MP6 – Eccentric Reducer

Tube OD in	Part Number		A in	Packing		Weight lb
	304	316/L		Inner	Master	
2 x 1	S773214MP420010	S773214MP620010	5.00	6	12	0.4
2 x 1-1/2	S773214MP420014	S773214MP620014	3.00	6	12	0.4
2-1/2 x 1-1/2	S773214MP424014	S773214MP624014	5.00	6	12	0.5
2-1/2 x 2	S773214MP424020	S773214MP624020	3.00	6	12	0.5
3 x 1-1/2	S773214MP430014	S773214MP630014	7.00	2	4	1.2
3 x 2	S773214MP430020	S773214MP630020	5.00	3	6	1.0
3 x 2-1/2	S773214MP430024	S773214MP630024	3.00	4	8	0.7
4 x 2	S773214MP440020	S773214MP640020	9.12	-	10	2.1
4 x 2-1/2	S773214MP440024	S773214MP640024	7.12	-	15	1.9
4 x 3	S773214MP440030	S773214MP640030	5.12	-	18	1.7

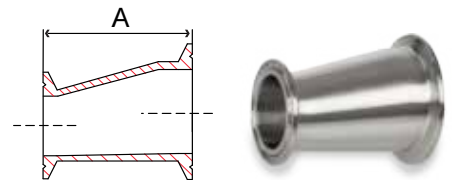

Fig. S7721MP4 & S7721MP6 – Male Adapter

Tube OD x MNPT	Part Number		A in	Packing		Weight lb
	304	316/L		Inner	Master	
1 x 3/4	S7721MP4010006	S7721MP6010006	2.19	10	40	0.8
1 x 1	S7721MP4010010	S7721MP6010010	2.25	10	40	0.8
1-1/2 x 1	S7721MP4014010	S7721MP6014010	2.44	10	20	0.9
1-1/2 x 1-1/2	S7721MP4014014	S7721MP6014014	2.25	10	20	0.9
1-1/2 x 2	S7721MP4014020	S7721MP6014020	2.62	10	20	1.6
2 x 2	S7721MP4020020	S7721MP6020020	2.64	6	12	1.4
2 x 1-1/2	S7721MP4020014	S7721MP6020014	2.63	12	24	1.2
3 x 1-1/2	S7721MP4030014	S7721MP6030014	3.00	3	6	2.3
3 x 2	S7721MP4030020	S7721MP6030020	3.00	3	6	2.3
3 x 2-1/2	S7721MP4030024	S7721MP6030024	3.00	-	4	2.4
3 x 3	S7721MP4030030	S7721MP6030030	3.00	-	4	2.4
4 x 3	S7721MP4040030	S7721MP6040030	3.30	-	4	3.4
4 x 4	S7721MP4040040	S7721MP6040040	3.16	-	5	3.5

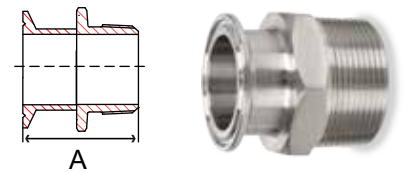
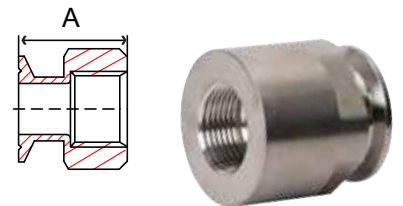

Fig. S7722MP4 & S7722MP6 – Female Adapter

Tube OD x FNPT	Part Number		A in	Packing		Weight lb
	304	316/L		Inner	Master	
1 x 3/4	S7722MP4010006	S7722MP6010006	1.63	8	32	0.6
1 x 1	S7722MP4010010	S7722MP6010010	1.63	8	32	0.7
1-1/2 x 1	S7722MP4014010	S7722MP6014010	2.25	16	32	1.0
1-1/2 x 1-1/2	S7722MP4014014	S7722MP6014014	2.25	16	32	1.0
1-1/2 x 2	S7722MP4014020	S7722MP6014020	2.25	16	32	1.2
2 x 1-1/2	S7722MP4020014	S7722MP6020014	2.35	6	12	1.3
2 x 2	S7722MP4020020	S7722MP6020020	2.40	6	12	1.3
3 x 1-1/2	S7722MP4030014	S7722MP6030014	2.19	2	4	2.5
3 x 2	S7722MP4030020	S7722MP6030020	2.19	2	4	2.6
3 x 2-1/2	S7722MP4030024	S7722MP6030024	2.19	2	4	2.6
3 x 3	S7722MP4030030	S7722MP6030030	2.19	2	4	2.7
4 x 3	S7722MP4040030	S7722MP6040030	2.19	-	5	5.0
4 x 4	S7722MP4040040	S7722MP6040040	2.62	-	5	5.0



Dimensions may change at any time due to continuous product development.

Fig. S7719WB4 - Weld x Male NPT Adapter

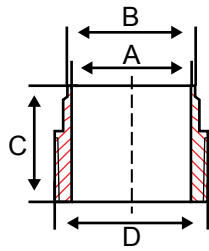

Tube OD in	Part Number 304	A in	B in	C in	D in	Packing		Weight lb
						Inner	Master	
1	S7719WB4010	0.87	1.00	1.75	1.00	40	80	0.2
1-1/2	S7719WB4014	1.37	1.50	1.75	1.50	20	40	0.2
2	S7719WB4020	1.87	2.00	1.81	2.00	12	24	0.3
2-1/2	S7719WB4024	2.37	2.50	2.31	2.50	5	10	1.0
3	S7719WB4030	2.87	3.00	2.50	3.00	2	4	1.7
4	S7719WB4040	3.83	4.00	2.56	4.00	-	5	2.5

Fig. S7714RMP4 & S7714RMP6 - Recessless Ferrule (Roll-On)

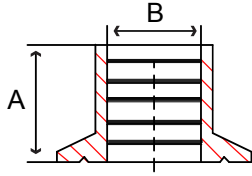

Tube OD in	Part Number		A in	B in	Packing		Weight lb
	304	316/L			Inner	Master	
1	S7714RMP4010	S7714RMP6010	0.75	1.00	25	100	0.1
1-1/2	S7714RMP4014	S7714RMP6014	1.12	1.50	20	80	0.1
2	S7714RMP4020	S7714RMP6020	1.31	2.00	9	36	0.2
2-1/2	S7714RMP4024	S7714RMP6024	1.37	2.50	12	24	0.3
3	S7714RMP4030	S7714RMP6030	1.43	3.00	6	12	0.4
4	S7714RMP4040	S7714RMP6040	1.50	4.00	4	8	0.7

Fig. S7714A4 - Long Plain Bevel Seat Ferrule

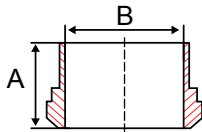

Tube OD in	Part Number 304	A in	B in	Packing		Weight lb
				Inner	Master	
1-1/2	S7714A4014	1.50	1.37	16	64	0.3
2	S7714A4020	1.50	1.87	20	40	0.4
3	S7714A4030	1.75	2.87	6	12	0.6

Fig. S77L14AM74 & S77L14AM76 - Long-Weld Ferrule

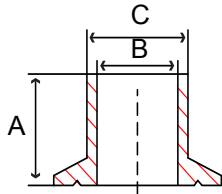

Tube OD in	Part Number		A in	B in	C in	Packing		Weight lb
	304	316/L				Inner	Master	
1/2	-	S77L14AM76004	1.12	0.37	0.50	50	200	0.1
3/4	-	S77L14AM76006	1.12	0.62	0.75	50	200	0.1
1	S77L14AM74010	S77L14AM76010	1.12	0.87	1.00	20	80	0.2
1-1/2	S77L14AM74014	S77L14AM76014	1.12	1.37	1.50	20	80	0.2
2	S77L14AM74020	S77L14AM76020	1.12	1.87	2.00	9	36	0.2
2-1/2	S77L14AM74024	S77L14AM76024	1.12	2.37	2.50	6	24	0.3
3	S77L14AM74030	S77L14AM76030	1.12	2.87	3.00	10	20	0.3
4	S77L14AM74040	S77L14AM76040	1.12	3.83	4.00	6	12	0.5
6	S77L14AM74060	-	1.12	5.78	6.00	-	8	1.1
8	S77L14AM74080	-	1.12	7.78	8.00	-	4	1.8

Fig. S7714WMP4 & S7714WMP6 - Short-Weld Ferrule

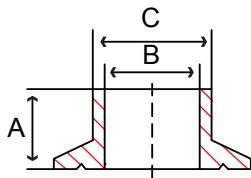

Tube OD in	Part Number		A in	B in	C in	Packing		Weight lb
	304	316/L				Inner	Master	
1/2	-	S7714WMP6004	0.50	0.37	0.50	100	400	0.1
3/4	-	S7714WMP6006	0.50	0.62	0.75	100	400	0.1
1	S7714WMP4010	S7714WMP6010	0.50	0.87	1.00	40	160	0.1
1-1/2	S7714WMP4014	S7714WMP6014	0.50	1.37	1.50	80	160	0.2
2	S7714WMP4020	S7714WMP6020	0.50	1.87	2.00	60	120	0.2
2-1/2	S7714WMP4024	S7714WMP6024	0.50	2.37	2.50	40	80	0.3
3	S7714WMP4030	S7714WMP6030	0.50	2.87	3.00	20	40	0.3
4	S7714WMP4040	S7714WMP6040	0.62	3.83	4.00	12	24	0.4
6	S7714WMP4060	-	0.88	5.78	6.00	-	10	0.5

Fig. S7714PRF4 - Short Plain Bevel Seat Ferrule

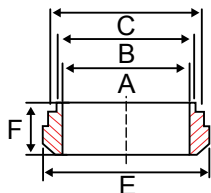

Tube OD in	Part Number 304	A in	B in	C in	E in	F in	Packing		Weight lb
							Inner	Master	
1-1/2	S7714PRF4014	1.37	1.50	1.67	1.84	0.72	24	96	0.2
2	S7714PRF4020	1.87	2.00	2.19	2.37	0.75	30	60	0.3
3	S7714PRF4030	2.87	3.00	3.22	3.43	0.90	12	24	0.5

Dimensions may change at any time due to continuous product development.

Fig. S7715TRF4 - Short Threaded Bevel Seat Ferrule

Tube OD in	Part Number 304	A in	B in	C in	D in	Packing		Weight lb
						Inner	Master	
1-1/2	S7715TRF4014	1.37	1.50	2.00	0.72	12	48	0.2
2	S7715TRF4020	1.87	2.00	2.50	0.75	10	40	0.3
3	S7715TRF4030	2.87	3.00	3.50	0.90	12	24	0.7

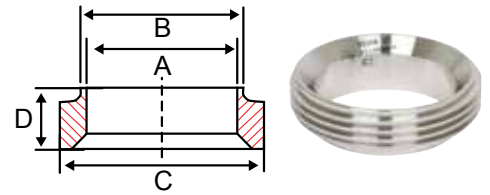

Fig. S7715A4 - Long Thread Bevel Seat Ferrule

Tube OD in	Part Number 304	A in	B in	Packing		Weight lb
				Inner	Master	
1-1/2	S7715A4014	1.50	1.37	10	40	0.3
2	S7715A4020	1.50	1.87	12	24	0.4
3	S7715A4030	1.75	2.87	6	12	0.8

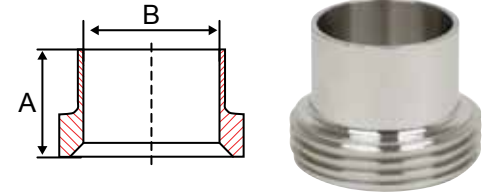

Fig. S7714WI4 - Male I-line Short Weld Ferrule

Tube OD in	Part Number 304	A in	B in	C in	D in	E in	Packing		Weight lb
							Inner	Master	
1-1/2	S7714WI4014	1.37	1.51	1.74	1.99	0.94	24	96	0.2
2	S7714WI4020	1.87	2.01	2.24	2.64	1.03	20	40	0.3
3	S7714WI4030	2.87	3.01	3.30	3.87	1.22	10	20	0.7

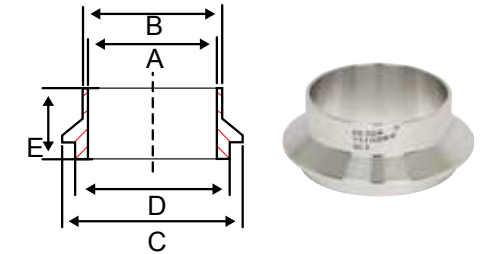

Fig. S7715WI4 - Female I-line Short Weld Ferrule

Tube OD in	Part Number 304	A in	B in	C in	D in	E in	Packing		Weight lb
							Inner	Master	
1-1/2	S7715WI4014	1.37	1.51	1.76	1.99	0.94	30	120	0.2
2	S7715WI4020	1.87	2.01	2.26	2.64	1.03	30	60	0.4
3	S7715WI4030	2.87	3.01	3.31	3.87	1.22	12	24	0.7

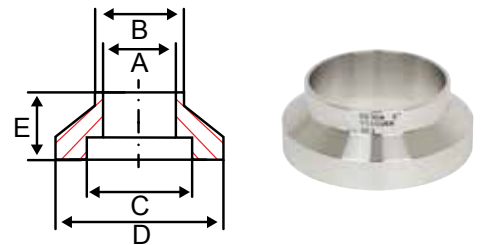

Fig. S7714WLMP4 - Tank Welding Ferrules (light duty)

Tube OD in	Part Number 304	A in	B in	C in	D in	Packing		Weight lb
						Inner	Master	
1-1/2	S7714WLMP4014	1.37	1.50	2.00	3.00	12	48	0.3
2	S7714WLMP4020	1.87	2.00	2.52	3.00	6	24	0.4
3	S7714WLMP4030	2.87	3.00	3.58	4.00	6	12	0.6

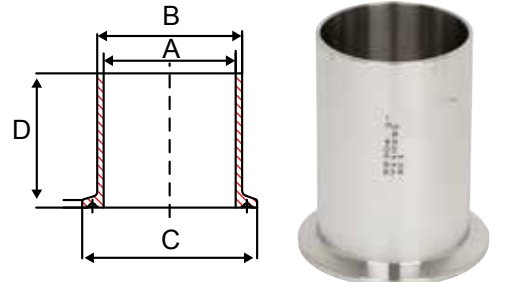

Fig. S7714MPW6 - Heavy Tank Weld Ferrule

Tube OD in	Part Number 316/L	A in	B in	C in	D in	Packing		Weight lb
						Inner	Master	
1-1/2	S7714MPW6014	1.37	1.68	2.00	1.63	12	48	0.3
2	S7714MPW6020	1.87	2.19	2.52	1.75	6	24	0.4
3	S7714MPW6030	2.87	3.22	3.58	1.82	6	12	0.6

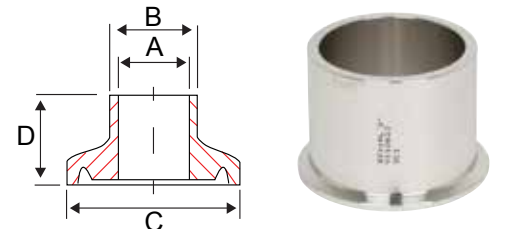
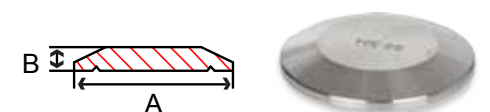

Fig. S7716AMP4 & S7716AMP6 - Solid End Cap

Tube OD in	Part Number		A in	B in	Packing		Weight lb
	304	316/L			Inner	Master	
1/2 & 3/4	-	S7716AMP6006	0.98	0.18	70	280	0.1
1 & 1-1/2	S7716AMP4014	S7716AMP6014	1.98	0.25	160	320	0.2
2	S7716AMP4020	S7716AMP6020	2.51	0.25	30	120	0.3
2-1/2	S7716AMP4024	S7716AMP6024	3.04	0.25	20	80	0.4
3	S7716AMP4030	S7716AMP6030	3.57	0.25	20	40	0.9
4	S7716AMP4040	S7716AMP6040	4.68	0.31	10	20	1.2
6	S7716AMP4060	-	6.55	0.35	-	10	1.5



Dimensions may change at any time due to continuous product development.

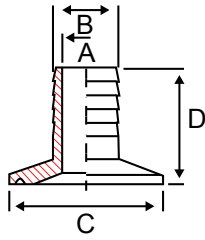

Fig. S7714MPHR4 - Rubber Hose Adapter

Tube OD in	Part Number 304/304L	A in	B in	C in	D in	Packing		Weight lb
						Inner	Master	
1	S7714MPHR4010	0.81	1.00	1.99	1.69	12	48	0.2
1-1/2	S7714MPHR4014	1.31	1.50	1.99	1.69	12	48	0.2
2	S7714MPHR4020	1.81	2.00	2.52	2.31	4	16	0.4

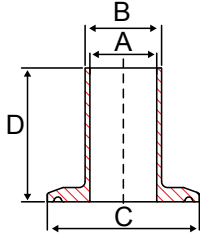

Fig. S7714MPHT6 - Tygon® Hose Adapter

Tube OD in	Part Number 316/316L	A in	B in	C in	D in	Packing		Weight lb
						Inner	Master	
1	S7714MPHT6010	0.81	1.00	1.99	4.50	12	48	0.2
1-1/2	S7714MPHT6014	1.31	1.50	1.99	4.50	12	48	0.2
2	S7714MPHT6020	1.81	2.00	2.52	4.50	4	16	0.4

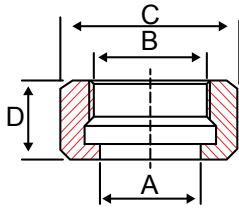

Fig. S7713H4 - Bevel Seat Hex Nut

Tube OD in	Part Number 304	A in	B in	C in	D in	Packing		Weight lb
						Inner	Master	
1-1/2	S7713H4014	1.70	2.00	2.40	0.97	-	50	0.5
2	S7713H4020	2.20	2.50	3.00	1.06	20	40	0.8
3	S7713H4030	3.25	3.62	4.19	1.28	-	20	1.9

SANITARY

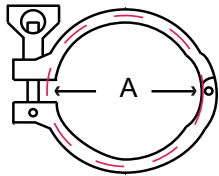

Fig. S7713MHHM4 - Heavy Duty Clamp

Tube OD in	Part Number 304	A in	Packing		Weight lb
			Inner	Master	
1/2 & 3/4	S7713MHHM4006	1.10	20	80	0.2
1 & 1-1/2	S7713MHHM4014	2.12	12	48	0.6
2	S7713MHHM4020	2.65	10	40	0.7
2-1/2	S7713MHHM4024	3.18	8	32	0.8
3	S7713MHHM4030	3.71	6	24	1.0
4	S7713MHHM4040	4.82	6	12	1.2
6	S7713MHHM4060	6.69	-	15	3.7
8	S7713MHHM4080	8.66	-	10	3.1

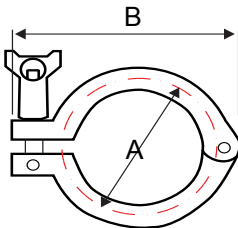

Fig. S7713IS4 - Heavy Duty I-line Clamp

Tube OD in	Part Number 304	A in	B in	Packing		Weight lb
				Inner	Master	
1-1/2	S7713IS4014	2.10	3.30	12	48	0.5
2	S7713IS4020	2.65	4.37	10	40	0.8
3	S7713IS4030	4.03	5.36	15	30	1.9

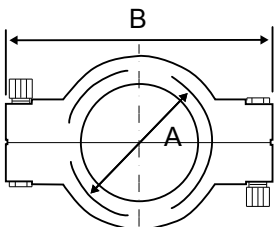

Fig. S7713MHP4 - High Pressure Clamp

Tube OD in	Part Number 304	A in	B in	Packing		Weight lb
				Inner	Master	
1/2 & 3/4	S7713MHP4006	1.10	2.93	20	80	0.8
1 & 1-1/2	S7713MHP4014	1.71	3.73	30	60	1.0
2	S7713MHP4020	2.22	4.36	15	30	1.2
2.5	S7713MHP4024	2.74	4.93	15	30	1.3
3	S7713MHP4030	3.40	5.47	-	25	1.5
4	S7713MHP4040	4.40	6.50	-	20	1.8
6	S7713MHP4060	6.33	8.50	-	10	2.8

Dimensions may change at any time due to continuous product development.

Fig. S7740MPE, S7740MPG & S7740MPU – Gaskets

Size in	EPDM Gasket* Part Number -55°F to 275°F	PTFE Gasket Part Number -40°F to 450°F	BUNA-N Gasket Part Number -30°F to 200°F
1/2	S7740MPE004	S7740MPG004	S7740MPU004
3/4	S7740MPE006	S7740MPG006	S7740MPU006
1	S7740MPE010	S7740MPG010	S7740MPU010
1-1/2	S7740MPE014	S7740MPG014	S7740MPU014
2	S7740MPE020	S7740MPG020	S7740MPU020
2-1/2	S7740MPE024	S7740MPG024	S7740MPU024
3	S7740MPE030	S7740MPG030	S7740MPU030
4	S7740MPE040	S7740MPG040	S7740MPU040
6	S7740MPE060	S7740MPG060	S7740MPU060



*Do not use with any hydrocarbons.

Fig. S77TH4P4 – Hanger with Sleeves

Fig. S77TH4R4 – Hanger with Grommets

Tube OD in	Part Number		A in	B in	Weight lb
	w/ Sleeves	w/ Grommets			
1	S77TH4P4010	S77TH4R4010	3.42	1.45	0.4
1-1/2	S77TH4P4014	S77TH4R4014	4.00	2.12	0.5
2	S77TH4P4020	S77TH4R4020	4.50	2.50	0.5
2-1/2	S77TH4P4024	S77TH4R4024	4.75	3.12	0.6
3	S77TH4P4030	S77TH4R4030	5.50	3.75	0.7
4	S77TH4P4040	S77TH4R4040	6.75	4.75	0.9
6	S77TH4P4060	S77TH4R4060	8.00	5.75	1.9

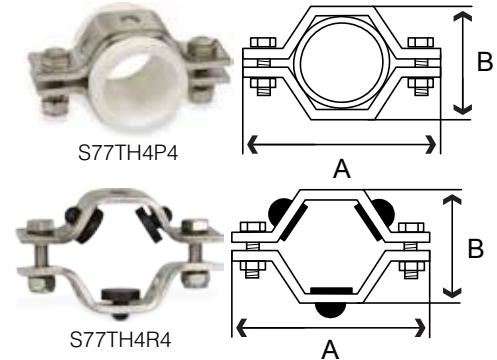

Fig. S62TP4 & S62TP6 – Sanitary Tubing

Tube OD in	Part Number		Wall Thickness in	I.D. in	Tube Length ft	Weight lb / ft
	304/304L	316/316L				
1/2	S62TP46004	S62TP66004	0.065	0.370	20	0.3
3/4	S62TP46006	S62TP66006	0.065	0.620	20	0.5
1	S62TP46010	S62TP66010	0.065	0.870	20	0.6
1-1/2	S62TP46014	S62TP66014	0.065	1.370	20	0.9
2	S62TP46020	S62TP66020	0.065	1.870	20	1.3
2-1/2	S62TP46024	S62TP66024	0.065	2.370	20	1.6
3	S62TP46030	S62TP66030	0.065	2.870	20	2.0
4	S62TP48040	S62TP68040	0.083	3.834	20	3.4
6	S62TP49060	S62TP69060	0.109	5.782	20	5.3



SANITARY

Tube Plate Flanges

Tube OD Size in	Part Numbers		Thickness (T)	Outside Diameter (OD)	Inside Diameter (ID)	Number of Bolt Holes	Bolt Hole Diameter in	Bolt Circle in	Weight lb
	304/304L	316/316L							
1	S1414SOTP010	S1416SOTP010	0.500	4.25	1.06	4	0.625	3.12	1.7
1-1/2	S1414SOTP014	S1416SOTP014	0.500	5.00	1.56	4	0.625	3.88	2.3
2	S1414SOTP020	S1416SOTP020	0.500	6.00	2.06	4	0.75	4.75	3.2
2-1/2	S1414SOTP024	S1416SOTP024	0.500	7.00	2.56	4	0.75	5.50	4.5
3	S1414SOTP030	S1416SOTP030	0.500	7.50	3.06	4	0.75	6.00	4.8
4	S1414SOTP040	S1416SOTP040	0.500	9.00	4.06	8	0.75	7.50	6.5
6	S1414SOTP060	S1416SOTP060	0.500	11.00	6.06	8	0.875	9.50	8.2

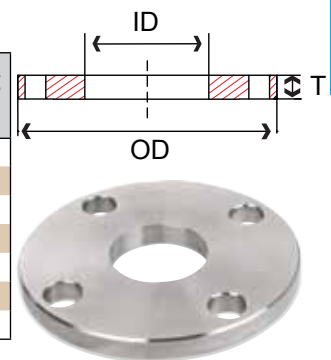

Gasket Material Properties

PROPERTIES	BUNA-N	PTFE®	VITON®	SILICON	EPDM
TEMPERATURE RANGE	-65°F TO 200°F	-40°F TO 450°F	-20°F TO 400°F	-80°F TO 450°F	-55°F TO 275°F
ACID RESISTANCE	GOOD	EXCELLENT	GOOD	GOOD	GOOD/EXCELLENT
ALKALI RESISTANCE	GOOD	EXCELLENT	POOR/GOOD	POOR/FAIR	GOOD/EXCELLENT
ABRASION RESISTANCE	EXCELLENT	EXCELLENT	GOOD	GOOD/EXCELLENT	GOOD/EXCELLENT
COMPRESSION SET	GOOD	COLD FLOWS	GOOD/EXCELLENT	GOOD/EXCELLENT	FAIR

Pressure Ratings for Sanitary Clamps

Size OD (in)	HEAVY DUTY 13MHHM (psi)		HIGH PRESSURE 13MHP (psi)		HEAVY DUTY I-LINE 13IS (psi)	
	@70°F	@250°F	@70°F	@250°F	@70°F	@250°F
1/2"	1500	1200	1500	1200		
3/4"	1500	1200	1500	1200		
1"	500	250	1500	1200	700	250
1-1/2"	500	250	1500	1200	700	250
2"	450	250	1000	800	450	250
2-1/2"	400	200	1000	800	450	200
3"	350	150	1000	800	350	150
4"	200	125	1000	800	200	125
6"	200	125	200	200	150	100
8"	180	100				



Series S77 Sanitary Butterfly Valve



Port: Full Tube Port
 Size: 1" to 6"
 Material: 304 Stainless Steel
 Ends: Clamp Ends
 Pressure: 150 PSI
 Temperature: 200° F

- Stainless steel precision milled body
- SCI logo, material grade, size, heat number and country of origin engraved on each valve body
- Disc fully machined and polished
- Pull handle 4 position, blue 11 position handle, stainless steel 11 position handle
- Hygienic seating design

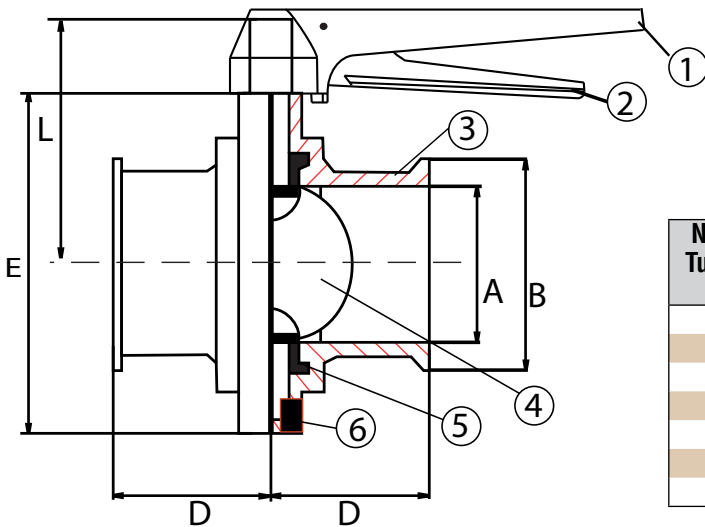

- No. Part Name**
- 1 Handle
 - 2 Gripper
 - 3 Body
 - 4 Disc
 - 5 Seat
 - 6 Bolt

Nominal Tube Size IN	A IN	B IN	D IN	E IN	L IN
1	0.87	1.99	1.75	3.11	2.40
1-1/2	1.37	1.99	1.75	3.35	2.53
2	1.87	2.52	1.87	4.13	2.93
2-1/2	2.37	3.05	1.91	4.41	3.06
3	2.84	3.58	2.03	4.92	3.34
4	3.84	4.69	2.03	6.18	4.00
6	5.80	6.56	2.80	8.63	5.28

S774 E C T 020

Valve Material	
4	304 Stainless Steel

Seat Material	
E	EPDM
S	Silicon
V	Viton

End Type	
C	Tri-Clamp

Operator	
T	11 Position Blue Plastic Lever Handle 1"-3"
B	Bare Stem
S	11 Position Stainless Steel Lever Handle 1"-4"
P	4 Position Pull Handle 1"-6"

Size in	
010	1
014	1-1/2
020	2
024	2-1/2
030	3
040	4
060	6

SANITARY



Series S7745MP6
316 Stainless Steel - Sanitary
Clamp End Check Valve

- 150 psi CWP ambient
- All wetted parts approved for use in food processing
- All wetted parts polished to 180 grit



Tube OD in	Part Number	Weight lb
	Instrumentation	
1-1/2	S7745MP6014	2.6
2	S7745MP6020	3.1
3	S7745MP6030	5.2
4	S7745MP6040	10.4

Fig. S7754MP6
316 Stainless Steel
Sanitary Sight Glass

- 150 psi CWP ambient
- 3A clamp ends
- EPDM standards, Silicon & Viton available upon request



Tube OD in	Part Number	Packing		Weight lb
	316/L	Inner	Master	
1-1/2	S7754MP6014	-	1	2.4
2	S7754MP6020	-	1	2.5
3	S7754MP6030	-	1	4.4
4	S7754MP6040	-	1	7.0



Series N66
Sanitary Ball Valve

- 316 stainless steel
- Tube port
- Three-piece design
- High cycle stem
- Hygienic seating
- ISO 5211 mounting pad
- Locking device
- Encapsulated body seal



Size in	Part Number	Weight lb
	Clamp Ends	
1/2	SVN6666MTCE004	1.2
3/4	SVN6666MTCE006	2.0
1	SVN6666MTCE010	3.0
1-1/2	SVN6666MTCE014	6.0
2	SVN6666MTCE020	9.2
2-1/2	SVN6666MTCE024	12.1
3	SVN6666MTCE030	16.2
4	SVN6666MTCE040	18.9

Part number listed is for configuration listed on this page with clamp ends.
A full listing of configurations can be found at www.sharpevalves.com



Series 66
Sanitary Ball Valve

- 316L stainless steel
- Tube port
- Three-piece design
- High cycle stem
- Hygienic seating
- ISO mounting pad
- Locking device
- Encapsulated body seal

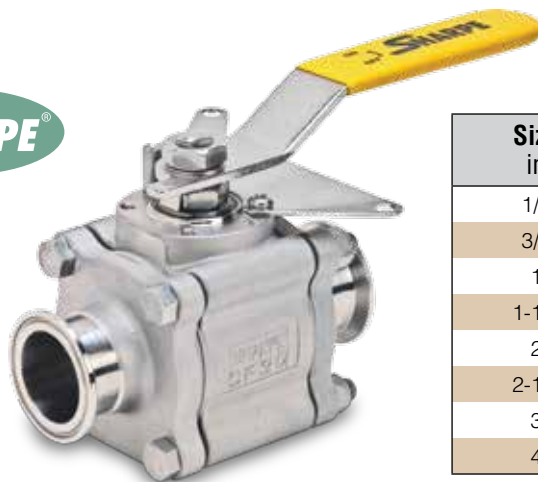

Size in	Part Number	Weight lb
	Clamp Ends	
1/2	SV6666MTCE004	1.2
3/4	SV6666MTCE006	2.0
1	SV6666MTCE010	3.0
1-1/2	SV6666MTCE014	6.0
2	SV6666MTCE020	9.2
2-1/2	SV6666MTCE024	12.1
3	SV6666MTCE030	16.2
4	SV6666MTCE040	18.9

Part number listed is for configuration listed on this page with clamp ends. A full listing of configurations and flow plans can be found at www.sharpevalves.com

S
A
N
I
T
A
R
Y

**Series 75
Sanitary 3 & 4 Way Ball Valve**

- Tube Full Port
- Size 1/4" to 2"
- Available in 316L Stainless Steel
- Ends: NPT, SW
- Pressure up to 1000 PSI*
- Temperature up to 450° F*
- ISO 5211 Mounting Pad
- TFM Seats
- 4-Seat Design
- "L" or "T" Port Balls
- 10 Different Flow Configurations
- Direct Mount Design
- Lockable Lever Handle Standard
- Extended or Oval Handle Optional
- Live Loaded Stem Packing
- Blowout Proof Stem



**Series D88
Diverter Ball Valve**

- 1/2" to 4"
- 316L stainless steel
- Tube full port
- Variety of seats, seals and aseptic end connections
- 3-Piece design
- ASME/BPE - 2009 compliant
- Integral mounting pad
- Locking device
- Encapsulated body bolts



**Series 66
with Tank Bottom Pad**

- 1/2" to 4"
- 316L stainless steel
- Tube full port
- Blow out proof stem
- High cycle stem packing
- Variety of seats and seals
- 3-Piece design
- Integral ISO mounting pad
- Locking device
- Encapsulated body bolts



Part number listed is for configuration listed on this page with the addition of a L-Port 90° Turn Ball and 240 Grit Clamp Ends.
A full listing of configurations and flow plans can be found at www.sharpevalves.com



- Sanitary tubing is 3-A approved
- All Sanitary tubing is individually wrapped and capped



- Boxed and crated for protection during shipping
- Reduced chance of shipping damage

S
A
N
I
T
A
R
Y