

# FLOOR OR SHOWER DRAINS WITH ADJUSTABLE STRAINER HEADS

**FUNCTION:** General service floor drain for use in showers, toilets, kitchens and other finished areas where foot traffic is expected. The round top strainer head is used for all types of poured finished floors. The square top is particularly adaptable to floors that are finished in material of square or straight line pattern. Reversible flashing collar permits adjustment of the strainer to meet finished floor level.

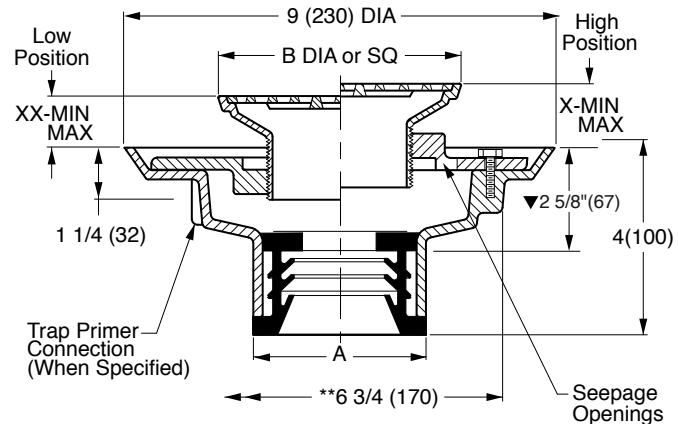
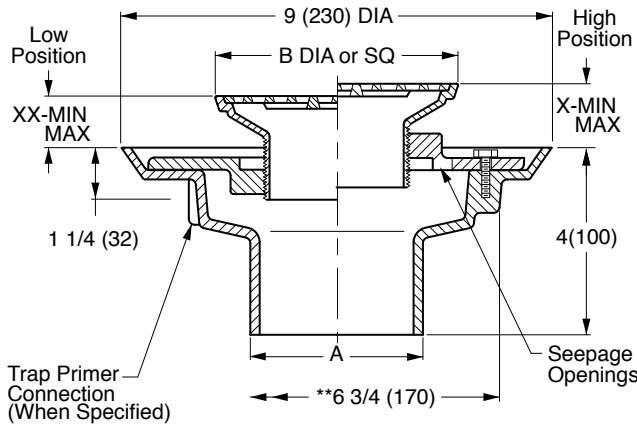

A (Pipe Size) = 02(50), 03(75), 04(100), 05(125) or 06(150)

**NO-HUB OUTLET**

- Fig. 2005Y.....(A) ROUND TOP
- Fig. 2005Y.....(B) SQUARE TOP

**SPEEDI-SET OUTLET**

- Fig. 2005L.....(A) ROUND TOP
- Fig. 2005L.....(B) SQUARE TOP

Outlet Size	Nickel Bronze Strainer Head
▲ 02(50)	05(125) DIA or SQ
▲ 03(75)	06(150) DIA or SQ
▲ 04(100)	08(205) DIA or SQ

Strainer Size B DIA or SQ	*Collar In High Position X		*Collar In Low Position XX		Free Area SQ IN (SQ CM)	
	MIN	MAX	MIN	MAX	ROUND	SQUARE
05 (125)	1 1/4(32)	2 1/4(57)	3/4(19)	1 5/8(41)	7(45)	6.5(42)
06 (150)	1 1/4(32)	2 1/4(57)	3/4(19)	1 5/8(41)	9(58)	12.5(81)
07 (180)	1 1/4(32)	2 1/4(57)	7/8(22)	1 7/8(48)	14(90)	11(71)
08 (205)	1 1/2(38)	2 1/2(64)	1(25)	1 7/8(48)	17(110)	14(90)
*09 (230)	1 1/2(38)	2 3/8(60)	1(25)	1 7/8(48)	18(116)	16(103)
*10 (255)	1 1/2(38)	2 3/8(60)	1(25)	1 7/8(48)	23(48)	16(103)

- ▼ This dimension to internal stop of speedi-set gasket.
- Add 3/8"(10) to all min/max dimensions for round strainers.
- \* Collar is reversible to obtain extreme high and low strainer positions.
- \*\* Not available for 5"(125) size strainer.
- \*\* MIN 6 3/4"(170) hole required for core drilled application.

**REGULARLY FURNISHED:**

Duco Cast Iron Body with Flashing Collar and Adjustable Strainer Head as Indicated by Suffix Letter Selected.

**VARIATIONS:**

- Flapper Type Backwater Valve -V
- \*\*  Hinged Grate -H
- L Speedi-Set Service Weight 2(50), 3(75) & 4"(100) only
- LXH Speedi-Set Extra Heavy 2(50), 3(75) & 4"(100) only
- Sediment Bucket -B
- Trap Primer Connection -P050 1/2" (13) & -P075 3/4" (19)
- Vandal Proof Screws -U
- Wide Flanged Strainer (Specify Fig. DX2005)
- T Threaded Outlet
- Heelproof Grate -HP -AHP (Round) or -BHP (Square)
- Quad Close Trap Seal (Specify Fig. 2692)

**OPTIONAL MATERIALS:**

- Bronze Body -BB
- Chrome Plated Strainer -CP
- Galvanized Cast Iron Body -G
- Nickel Bronze Strainer -NB
- Polished Bronze Strainer -PB
- All Stainless Steel (Specify Fig. 9700)
- Stainless Steel Strainers -SS [Available in 05(125) & 06(150) sizes only]

**NOTE:** Dimensions shown in parentheses are in millimeters.

- ▲ Meets ASME Standard A112.6.3-2001 02(50), 03(75) or 04"(100) sizes only.

SEE PM0457 FOR OPTIONAL STRAINER HEADS.

DRAWING NUMBER S2005  
 SCALE: NONE  
 DATE: 5-17-85  
 APPROVED BY: TD  
 CHECKED BY: TD  
 DRAWN BY: PJ  
 FIGURE NUMBER 2005

WE CAN ASSUME NO RESPONSIBILITY FOR USE OF SUPERSEDED OR VOID DATA  
 DIMENSIONS ARE SUBJECT TO MANUFACTURERS TOLERANCE AND CHANGE WITHOUT NOTICE

S	11-3-16	Revised Optional Materials	TBW	CL	WEIGHT POUNDS	VOLUME CUBIC FEET	FIGURE NUMBER <b>2005</b>
R	6-10-15	Revised Variations	TBW	CL			
Q	11-18-11	Rev. Dwg., Var.	TBW	CR			
P	11-20-09	Revised Variations	RN	BW			
REV.	DATE	DESCRIPTION	BY	CKD. BY			

H  
 DRAWING NUMBER **PM0457 SH 1 of 2**  
 SIZE **A**  
 SCALE **NONE**  
 DATE: **5-17-85**  
 APPROVED BY: **TD**  
 CHECKED BY: **TD**  
 DRAWN BY: **PJ**  
 2010 SERIES OPTIONAL STRAINER HEADS

ASSUME NO RESPONSIBILITY OR USE OF SUPERSEDED OR VOID DATA

# OPTIONAL STRAINER HEADS

## ROUND STRAINER

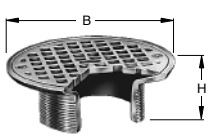

**MATERIALS:**  
 Chrome Plated -CP  
 Polished Bronze -PB  
 Nickel Bronze -NB  
 Stainless Steel  
 Strainers -SS [Available in 05(125) & 06(150) sizes only]

**VARIATIONS:**  
 •Hinged Grate (Specify Suffix -AH)  
 Sediment Bucket -B  
 Vandal Proof Screws -U

B DIA	05 (125)	06 (150)	07 (180)	08 (205)	09 (230)	10 (255)
H	2 (51)	2 (51)	2 1/4 (57)	2 1/2 (64)	2 1/2 (64)	2 3/4 (70)
X MIN	1 1/4 (32)	1 1/4 (32)	1 1/4 (32)	1 1/2 (38)	1 1/2 (38)	1 1/2 (38)
X MAX	2 1/4 (57)	2 1/4 (57)	2 1/4 (57)	2 1/2 (64)	2 1/2 (64)	2 3/4 (70)

Specify Type, Size & Finish eg: A05NB  
 \*Not available for 05" (125) size

**SUFFIX -A**

## FLAPPER TYPE BACKWATER VALVE

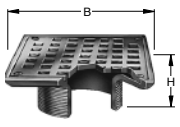

**FUNCTION:** Provides backwater protection at point where protection is needed.

**MATERIALS:**  
 Chrome Plated -CP  
 Polished Bronze -PB  
 Nickel Bronze -NB

**VARIATIONS:**  
 •Hinged Grate (Specify Suffix -AH)  
 Vandal Proof Screws -U

B DIA	05 (125)	06 (150)	07 (180)	08 (205)
H	2 (51)	2 (51)	2 1/4 (57)	2 1/2 (64)
X MIN	1 1/4 (32)	1 1/4 (32)	1 1/4 (32)	1 1/2 (38)
X MAX	2 1/4 (57)	2 1/4 (57)	2 1/4 (57)	2 1/2 (64)

Specify Type, Size & Finish eg: AV05NB  
 \*Not available for 05" (125) size

**SUFFIX -AV**

## SQUARE STRAINER

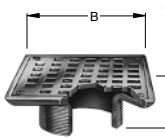

**MATERIALS:**  
 Chrome Plated -CP  
 Polished Bronze -PB  
 Nickel Bronze -NB

**VARIATIONS:**  
 Flapper Type Backwater Valve (Specify Suffix -BV) 05 (125), 06 (150), 07 (180) or 08" (205) sizes only  
 \*Hinged Grate (Specify Suffix -BH)  
 Sediment Bucket -B  
 Vandal Proof Screws -U

B DIA	05 (125)	06 (150)	07 (180)	08 (205)	09 (230)	10 (255)
H	2 (51)	2 (51)	2 1/4 (57)	2 1/2 (64)	2 1/4 (57)	2 1/4 (57)
X MIN	1 1/4 (32)	1 1/4 (32)	1 1/4 (32)	1 1/2 (38)	1 1/2 (38)	1 1/2 (38)
X MAX	2 1/4 (57)	2 1/4 (57)	2 1/4 (57)	2 1/2 (64)	2 1/4 (57)	2 3/8 (60)

Specify Type, Size & Finish eg: B05NB  
 \*Not available for 05" (125) size

**SUFFIX -B**

## STRAINER HEAD w/SQUARE HINGED COVER

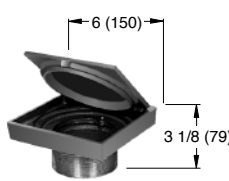

**MATERIALS:**  
 Chrome Plated -CP  
 Polished Bronze -PB  
 Nickel Bronze -NB

**VARIATIONS:**  
 Gasketed Water Tight Cover -GC  
 Secured Cover -SC  
 Secondary Strainer Grate-SG

Specify Type, Size & Finish eg: BSNB

**SUFFIX -BS**

## REINFORCED ROUND STRAINER

**FUNCTION:** Used in finished floors where light wheeled loads are anticipated.



**MATERIALS:**  
 Chrome Plated -CP  
 Polished Bronze -PB  
 Nickel Bronze -NB

**VARIATIONS:**  
 Flapper Type Backwater Valve (Specify Suffix -CV)  
 Sediment Bucket -B  
 Vandal Proof Screws -U

B DIA	05 (125)	06 (150)	08 (205)	10 (255)
H	2 (51)	2 (51)	2 1/2 (64)	2 3/4 (70)
MIN	1 1/4 (32)	1 1/4 (32)	1 1/2 (38)	1 7/8 (48)
MAX	2 1/4 (57)	2 1/4 (57)	2 1/2 (64)	2 3/4 (70)

Specify Type, Size & Finish eg: C06NB

**SUFFIX -C**

## REINFORCED TRACTOR STRAINER

**FUNCTION:** Used in finished floors where medium weight wheeled loads are anticipated and loose set non-tilt tractor grate is desired.

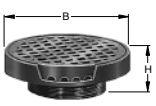

**MATERIALS:**  
 Cast Iron -CI  
 Chrome Plated -CP  
 Polished Bronze -PB  
 Nickel Bronze -NB

**VARIATIONS:**  
 Flapper Type Backwater Valve (Specify Suffix -DV or -EV)  
 Sediment Bucket -B  
 Vandal Proof Screws -U

SUFFIX	B DIA	H	X	
			MIN	MAX
-D	07 (180)	3 1/4 (83)	2 5/8 (67)	3 1/2 (89)
-E	09 (230)	3 1/2 (89)	2 3/4 (70)	3 1/2 (89)

Specify Type, Size & Finish eg: D09PB  
 E09PB

**SUFFIX -D-E**

## TILE FLANGE

**FUNCTION:** Provides integral flange set 5/32" (4) below rim to receive floor covering. Flange may have option of tapped holes for securing pan and gasket.

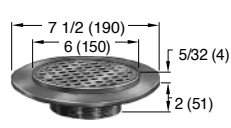

**MATERIALS:**  
 Chrome Plated -CP  
 Polished Bronze -PB  
 Nickel Bronze -NB

**VARIATIONS:**  
 Flapper Type Backwater Valve (Specify Suffix -FV)  
 Holes in Flange -SH  
 Sediment Bucket -B  
 Vandal Proof Screws -U

	X
MIN	MAX
1 1/4 (32)	2 1/8 (54)

Specify Type, Size & Finish eg: F06NB

**SUFFIX -F**

## ADJUSTABLE STRAINER HEAD

**FUNCTION:** Used in a non-traffic area when a funnel type strainer head is required and space does not allow use of the 3500 series funnel. The extended rim allows use as an anti-flood and anti-splash drip pan.

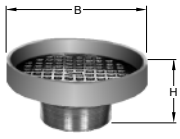

**VARIATIONS:**  
 Flapper Type Backwater Valve (Specify Suffix -F37V or F38V)

**MATERIALS:**  
 Cast Iron -CI  
 Chrome Plated -CP  
 Galvanized Cast Iron -G  
 Polished Bronze -PB  
 Nickel Bronze -NB

SUFFIX	-F37	-F38
B DIA	07 (180)	09 (230)
H	3 1/4 (83)	3 1/2 (89)
X MIN	2 5/8 (67)	2 3/4 (70)
X MAX	3 1/2 (89)	3 1/2 (89)

Specify Type, Size & Finish eg: F37NB F38CP

**SUFFIX -F37-F38**

H  
 G  
 E  
 F

Revised Suffix-A  
 Revised Suffix-BS  
 Revised  
 Revised Tables

TBW  
 RN  
 TBW  
 CMD





CL  
 CL  
 BS

**FIGURE NUMBER**  
 2010 SERIES OPTIONAL  
 STRAINER HEADS

REV.	DATE	DESCRIPTION	BY	CKD. BY
------	------	-------------	----	---------

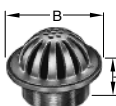
NOTE: Dimensions shown in parentheses are in millimeters.

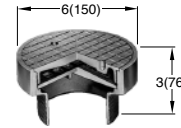
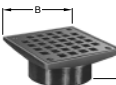
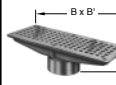
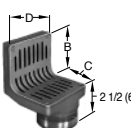
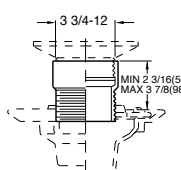
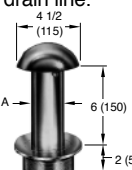
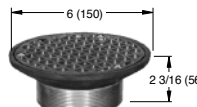
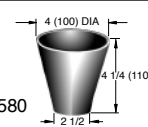
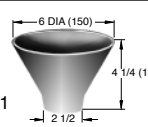
# OPTIONAL STRAINER HEADS

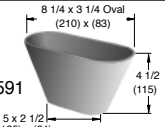
DRAWING NUMBER	LOW DOME STRAINER		SOLID HINGED COVER		SPANNER WRENCH COVER																																																																																
PM0457 SH 2 of 2	<p><b>FUNCTION:</b> Used in gutters and recessed areas where excessive debris build-up is expected. Dome insures drainage even when partly covered.</p> <p><b>MATERIALS:</b>            Chrome Plated -CP            Polished Bronze -PB            Nickel Bronze -NB</p> <p><b>VARIATIONS:</b>            Flapper Type Backwater Valve (Specify Suffix -GV)            Sediment Bucket -B            Vandal Proof Screws -U</p>  <table border="1" style="font-size: small;"> <tr><td>B DIA</td><td>05 (125)</td><td>06 (150)</td><td>08 (205)</td></tr> <tr><td>H</td><td>2 (51)</td><td>2 (51)</td><td>2 1/2 (64)</td></tr> <tr><td>MIN</td><td>1 1/4 (32)</td><td>1 1/4 (32)</td><td>1 1/2 (38)</td></tr> <tr><td>MAX</td><td>2 1/4 (67)</td><td>2 1/4 (67)</td><td>2 1/2 (64)</td></tr> </table>		B DIA	05 (125)	06 (150)	08 (205)	H	2 (51)	2 (51)	2 1/2 (64)	MIN	1 1/4 (32)	1 1/4 (32)	1 1/2 (38)	MAX	2 1/4 (67)	2 1/4 (67)	2 1/2 (64)	<p><b>FUNCTION:</b> Used in areas where intermittent drain use is required. Solid cover prevents intrusion of chips, saw-dust, etc., which are swept up before cover is opened for washdown. The secondary strainer prevents debris from entering the waste line.</p> <p><b>MATERIALS:</b>            Chrome Plated -CP            Polished Bronze -PB            Nickel Bronze -NB</p> <p><b>VARIATIONS:</b>            Flapper Type Backwater Valve (Specify Suffix -GV)            Vandal Proof Screws -U</p>  <table border="1" style="font-size: small;"> <tr><td>B DIA</td><td>05 (125)</td><td>06 (150)</td><td>07 (180)</td><td>08 (205)</td></tr> <tr><td>H</td><td>2 (51)</td><td>2 (51)</td><td>2 1/4 (67)</td><td>2 1/2 (64)</td></tr> <tr><td>X MIN</td><td>1 1/4 (32)</td><td>1 1/4 (32)</td><td>1 1/4 (32)</td><td>1 1/2 (38)</td></tr> <tr><td>X MAX</td><td>2 1/4 (67)</td><td>2 1/4 (67)</td><td>2 1/4 (67)</td><td>2 1/2 (64)</td></tr> </table>		B DIA	05 (125)	06 (150)	07 (180)	08 (205)	H	2 (51)	2 (51)	2 1/4 (67)	2 1/2 (64)	X MIN	1 1/4 (32)	1 1/4 (32)	1 1/4 (32)	1 1/2 (38)	X MAX	2 1/4 (67)	2 1/4 (67)	2 1/4 (67)	2 1/2 (64)	<p><b>FUNCTION:</b> Solid gas tight, vandal proof, threaded cover for areas where intermittent drain use is required.</p> <p><b>MATERIALS:</b>            Chrome Plated -CP            Polished Bronze -PB            Nickel Bronze -NB</p> <p><b>VARIATIONS:</b>            Flapper Type Backwater Valve (Specify Suffix -JV)            Sediment Bucket -B</p>  <table border="1" style="font-size: small;"> <tr><td colspan="2">6 (150)</td></tr> <tr><td colspan="2">3 (76)</td></tr> <tr><td>MIN</td><td>2 (51)</td></tr> <tr><td>MAX</td><td>3 (76)</td></tr> </table>		6 (150)		3 (76)		MIN	2 (51)	MAX	3 (76)																																			
B DIA	05 (125)	06 (150)	08 (205)																																																																																		
H	2 (51)	2 (51)	2 1/2 (64)																																																																																		
MIN	1 1/4 (32)	1 1/4 (32)	1 1/2 (38)																																																																																		
MAX	2 1/4 (67)	2 1/4 (67)	2 1/2 (64)																																																																																		
B DIA	05 (125)	06 (150)	07 (180)	08 (205)																																																																																	
H	2 (51)	2 (51)	2 1/4 (67)	2 1/2 (64)																																																																																	
X MIN	1 1/4 (32)	1 1/4 (32)	1 1/4 (32)	1 1/2 (38)																																																																																	
X MAX	2 1/4 (67)	2 1/4 (67)	2 1/4 (67)	2 1/2 (64)																																																																																	
6 (150)																																																																																					
3 (76)																																																																																					
MIN	2 (51)																																																																																				
MAX	3 (76)																																																																																				
SCALE	NONE		NONE		NONE																																																																																
DATE:	5-17-85		5-17-85		5-17-85																																																																																
APPROVED BY:	TD		TD		TD																																																																																
CHECKED BY:	TD		TD		TD																																																																																
DRAWN BY:	PJ		PJ		PJ																																																																																
2010 SERIES OPTIONAL STRAINER HEADS	<p><b>REINFORCED SQUARE STRAINER</b></p> <p><b>FUNCTION:</b> Used in finished floors where some light wheeled traffic is anticipated.</p> <p><b>MATERIALS:</b>            Chrome Plated -CP            Polished Bronze -PB            Nickel Bronze -NB</p> <p><b>VARIATIONS:</b>            Flapper Type Backwater Valve (Specify Suffix -KV)            Sediment Bucket -B            Vandal Proof Screws -U</p>  <table border="1" style="font-size: small;"> <tr><td>B SQ</td><td>05 (125)</td><td>06 (150)</td><td>07 (180)</td><td>08 (205)</td></tr> <tr><td>H</td><td>2 (51)</td><td>2 (51)</td><td>2 1/4 (67)</td><td>2 1/2 (64)</td></tr> <tr><td>X MIN</td><td>1 1/4 (32)</td><td>1 1/4 (32)</td><td>1 1/4 (32)</td><td>1 1/2 (38)</td></tr> <tr><td>X MAX</td><td>2 1/4 (67)</td><td>2 1/4 (67)</td><td>2 1/4 (67)</td><td>2 1/2 (64)</td></tr> </table>		B SQ	05 (125)	06 (150)	07 (180)	08 (205)	H	2 (51)	2 (51)	2 1/4 (67)	2 1/2 (64)	X MIN	1 1/4 (32)	1 1/4 (32)	1 1/4 (32)	1 1/2 (38)	X MAX	2 1/4 (67)	2 1/4 (67)	2 1/4 (67)	2 1/2 (64)	<p><b>RECTANGULAR STRAINER</b></p> <p><b>FUNCTION:</b> Used in finished floors where light wheeled loads and or heavy foot traffic are anticipated.</p> <p><b>MATERIALS:</b>            Chrome Plated -CP            Polished Bronze -PB            Nickel Bronze -NB</p> <p><b>VARIATIONS:</b>            Sediment Bucket -B            Vandal Proof Screws -U</p>  <table border="1" style="font-size: small;"> <tr><td>SUFFIX</td><td>L</td><td>M</td><td>N</td><td>P</td><td>R</td><td>T</td></tr> <tr><td>B x B'</td><td>4 1/2 (115)x8 (205)</td><td>4 (100)x12 (305)</td><td>5 (125)x9 (230)</td><td>5 (125)x13 (330)</td><td>6 (150)x10 (255)</td><td>5 (125)x17 (430)</td></tr> <tr><td>H</td><td>2 1/4 (67)</td><td>2 1/2 (64)</td><td>2 1/4 (67)</td><td>3 (76)</td><td>2 1/4 (67)</td><td>3 (76)</td></tr> <tr><td>X MIN</td><td>1 3/8 (35)</td><td>1 7/8 (48)</td><td>1 3/8 (35)</td><td>2 1/8 (54)</td><td>1 3/8 (35)</td><td>2 1/4 (67)</td></tr> <tr><td>X MAX</td><td>2 3/8 (60)</td><td>2 3/4 (70)</td><td>2 3/8 (60)</td><td>3 (76)</td><td>2 3/8 (60)</td><td>3 1/8 (79)</td></tr> </table>		SUFFIX	L	M	N	P	R	T	B x B'	4 1/2 (115)x8 (205)	4 (100)x12 (305)	5 (125)x9 (230)	5 (125)x13 (330)	6 (150)x10 (255)	5 (125)x17 (430)	H	2 1/4 (67)	2 1/2 (64)	2 1/4 (67)	3 (76)	2 1/4 (67)	3 (76)	X MIN	1 3/8 (35)	1 7/8 (48)	1 3/8 (35)	2 1/8 (54)	1 3/8 (35)	2 1/4 (67)	X MAX	2 3/8 (60)	2 3/4 (70)	2 3/8 (60)	3 (76)	2 3/8 (60)	3 1/8 (79)	<p><b>ANGLE STRAINER</b></p> <p><b>FUNCTION:</b> Shower room drain set at wall and floor junction. Vertical grate openings prevent drain stoppage should flat surface become covered.</p> <p><b>MATERIALS:</b>            Chrome Plated -CP            Polished Bronze -PB            Nickel Bronze -NB</p> <p><b>VARIATIONS:</b>            Vandal Proof Screws -U</p>  <table border="1" style="font-size: small;"> <tr><td>SUFFIX</td><td>B</td><td>C</td><td>D</td><td colspan="2">X</td></tr> <tr><td></td><td></td><td></td><td></td><td>MIN</td><td>MAX</td></tr> <tr><td>-V</td><td>3 1/2 (89)</td><td>3 1/2 (89)</td><td>4 1/2 (115)</td><td>1 5/8 (41)</td><td>2 5/8 (67)</td></tr> <tr><td>-W</td><td>6 3/4 (170)</td><td>6 3/4 (170)</td><td>6 1/2 (165)</td><td>1 5/8 (41)</td><td>2 5/8 (67)</td></tr> </table>		SUFFIX	B	C	D	X						MIN	MAX	-V	3 1/2 (89)	3 1/2 (89)	4 1/2 (115)	1 5/8 (41)	2 5/8 (67)	-W	6 3/4 (170)	6 3/4 (170)	6 1/2 (165)	1 5/8 (41)	2 5/8 (67)
B SQ	05 (125)	06 (150)	07 (180)	08 (205)																																																																																	
H	2 (51)	2 (51)	2 1/4 (67)	2 1/2 (64)																																																																																	
X MIN	1 1/4 (32)	1 1/4 (32)	1 1/4 (32)	1 1/2 (38)																																																																																	
X MAX	2 1/4 (67)	2 1/4 (67)	2 1/4 (67)	2 1/2 (64)																																																																																	
SUFFIX	L	M	N	P	R	T																																																																															
B x B'	4 1/2 (115)x8 (205)	4 (100)x12 (305)	5 (125)x9 (230)	5 (125)x13 (330)	6 (150)x10 (255)	5 (125)x17 (430)																																																																															
H	2 1/4 (67)	2 1/2 (64)	2 1/4 (67)	3 (76)	2 1/4 (67)	3 (76)																																																																															
X MIN	1 3/8 (35)	1 7/8 (48)	1 3/8 (35)	2 1/8 (54)	1 3/8 (35)	2 1/4 (67)																																																																															
X MAX	2 3/8 (60)	2 3/4 (70)	2 3/8 (60)	3 (76)	2 3/8 (60)	3 1/8 (79)																																																																															
SUFFIX	B	C	D	X																																																																																	
				MIN	MAX																																																																																
-V	3 1/2 (89)	3 1/2 (89)	4 1/2 (115)	1 5/8 (41)	2 5/8 (67)																																																																																
-W	6 3/4 (170)	6 3/4 (170)	6 1/2 (165)	1 5/8 (41)	2 5/8 (67)																																																																																
DIMENSIONS ARE SUBJECT TO MANUFACTURERS TOLERANCE AND CHANGE WITHOUT NOTICE	<p><b>EXTENSION ADAPTOR</b></p> <p><b>FUNCTION:</b> Used when a strainer head must be raised to accommodate deeper floor fill.</p> <p><b>REGULARLY FURNISHED:</b>            Duco Cast Iron -CI</p> <p><b>MATERIALS:</b>            Cast Bronze -CB            Galvanized Cast Iron -G</p>  <p><b>NOTE:</b> Extension can be stacked for increased maximum adjustment.</p>		<p><b>OVERFLOW WITH STANDPIPE</b></p> <p><b>FUNCTION:</b> Used as overflow drain in decorative pools, fish ponds or similar areas. Dome prevents floating objects from entering drain line.</p> <p><b>MATERIALS:</b>            Chrome Plated -CP            Nickel Bronze -NB            Polished Bronze -PB</p> <p><b>VARIATIONS:</b>            Less Dome -LD            Standpipe Height other than 6" (150) (Specify Height)</p>  <table border="1" style="font-size: small;"> <tr><td>SUFFIX</td><td>A</td><td colspan="2">X</td></tr> <tr><td></td><td>SIZE</td><td>MIN</td><td>MAX</td></tr> <tr><td>-Y</td><td>2 (51)</td><td>3/4 (19)</td><td>2 1/8 (54)</td></tr> <tr><td>-Z</td><td>3 (76)</td><td>3/4 (19)</td><td>2 1/8 (54)</td></tr> </table>		SUFFIX	A	X			SIZE	MIN	MAX	-Y	2 (51)	3/4 (19)	2 1/8 (54)	-Z	3 (76)	3/4 (19)	2 1/8 (54)	<p><b>HEAVY DUTY ADJUSTABLE</b></p> <p><b>FUNCTION:</b> Used in finished floors where light wheeled loads and or heavy foot traffic are anticipated.</p> <p><b>MATERIALS:</b>            Polished Bronze -PB            Rough Bronze -RB            Nickel Bronze -NB</p> <p><b>VARIATIONS:</b>            Flapper Type Backwater Valve (Specify Suffix -69V)            Sediment Bucket -B            Vandal Proof Screws -U</p>  <p>eg: A06NB-69</p>																																																																
SUFFIX	A	X																																																																																			
	SIZE	MIN	MAX																																																																																		
-Y	2 (51)	3/4 (19)	2 1/8 (54)																																																																																		
-Z	3 (76)	3/4 (19)	2 1/8 (54)																																																																																		
FIGURE NUMBER	<p><b>SUFFIX -X</b></p>  <p>Fig. 3580</p>		<p><b>SUFFIX -Y-Z</b></p>  <p>Fig. 3581</p>		<p><b>SUFFIX -69</b></p>  <p>Fig. 3590</p>																																																																																
	 <p>Fig. 3591</p>																																																																																				

REV.	DATE	DESCRIPTION	BY	CKD. BY	
K	10-20-17	Rev. Materials Suffix -H, -V-W	TBW	CL	<b>FIGURE NUMBER</b> <b>2010 SERIES OPTIONAL STRAINER HEADS</b> <b>2 of 2</b>
J	1-17-12	Rev. Variations of Suffix -J	TBW	AM	
H	8-24-99	Revised	TBW	BS	
G	6-11-99	Revised Tables	CMD	BS	
F	1-22-99	T Strainer was S Strainer	TBW	BS	

NOTE: Dimensions shown in parentheses are in millimeters.



**WARNING:** Cancer and Reproductive Harm - www.P65Warnings.ca.gov