

Optima® EAF-150



EAF-150



EAF-150-ISM-DPU-IC

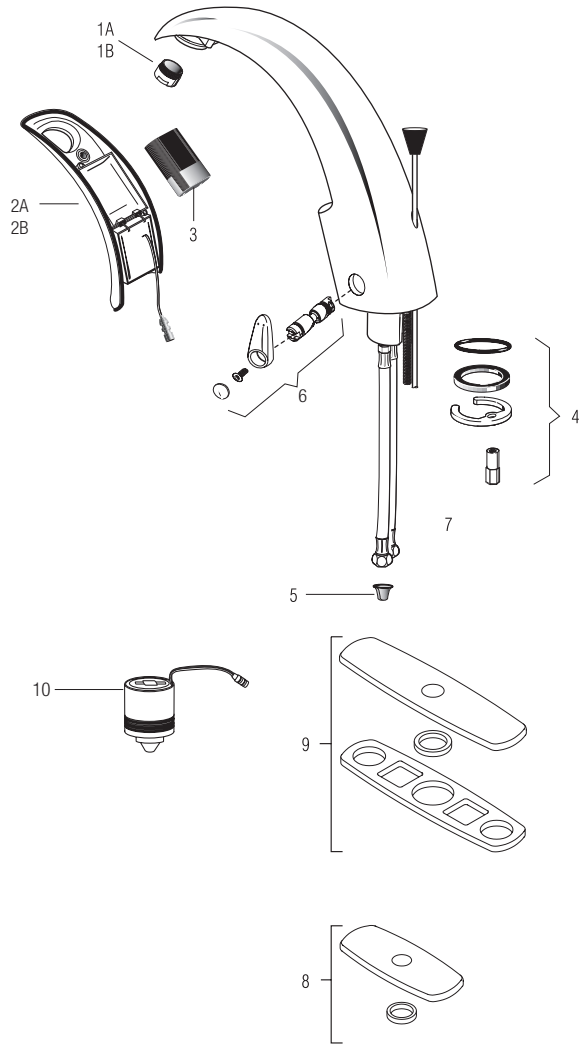

PARTS LIST—EAF-150 FAUCETS

Item No.	Code No.	Part No.	Description
1A.	0335008	EAF-10	2.2 gpm (8.3 Lpm) Aerator Spray Head
1B.	0335010	EAF-12	0.5 gpm (1.9 Lpm) Spray Head
1C.	0335029	EAF-51	0.35 gpm (1.3 Lpm) Spray Head (Multi-Lam)
2A.	0335002	EAF-3-A	Throat Plate Assembly (Battery Models)
2B.	0335003	EAF-4-A	Throat Plate Assembly with i.q.-cliq (Battery Model)
3.	3335009	EAF-1000	Battery Replacement Kit (6V 2CR5 with 2.5 mm Allen Wrench)
4.	0335000	EAF-1	Faucet Mounting Kit
5.	0335007	EAF-9	Strainer (Filter)
6.	3335118	EAF-1022	Mixer Handle Assembly and Cartridge (post 2004)
7.	3335023	EAF-1008	13" (330 mm) Flexible Supply Hose
8.	3365302	ETF-607-A	Trim Plate for 4" Center-set Sink
9.	3365303	ETF-608-A	Trim Plate for 8" Center-set Sink
10.	0335001	EAF-2	Solenoid

EAF-1001 Mixer Handle Assembly & Cartridge Discontinued (Faucets manufactured prior 2004).
Use Mixer Handle Assembly Cartridge kit EAF-1022-A (Faucets manufactured post 2004).

Optima® EAF-150

AUTO RANGE ADJUSTMENT

Press button one (1) time, then immediately step away.

Faucet will run for four (4) seconds and the range will automatically adjust to its environment.

Wait ten (10) seconds after water shuts off before using faucet.

If faucet **DOES NOT** function, refer to the troubleshooting section.

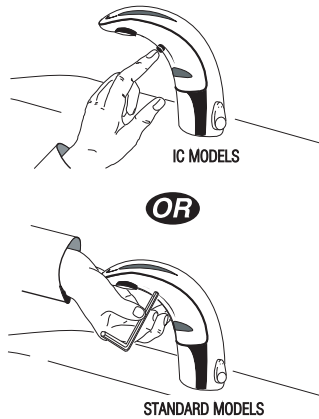

MANUAL RANGE ADJUSTMENT

Note: Use Manual range adjustment only when desired range cannot be obtained with auto range adjustment shown above.

Push button two (2) times (double click).

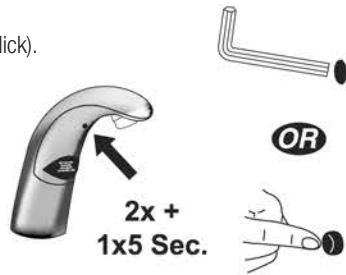

Push again and hold in button

LED flashes four (4) times,

Then release button and wait five (5) seconds,

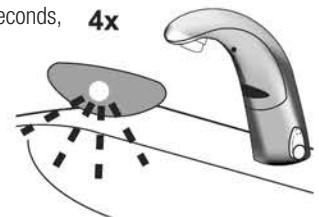

Continue to hold button in as faucet continuously cycles through the following five (5) range settings.

- One (1) flash = shortest range**
- Two (2) flashes = short range**
- Three (3) flashes = medium range**
- Four (4) flashes = long range**
- Five (5) flashes = longest range**

Release button at desired setting. Then water will flow for four (4) seconds signaling confirmation of setting. Wait an additional ten (10) seconds before using faucet.

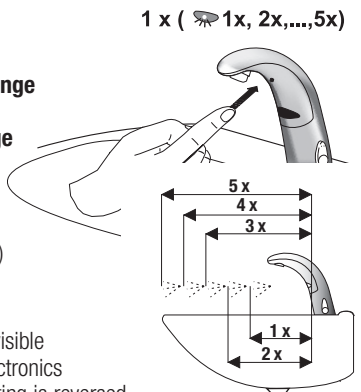

NOTE: Updated electronics have visible RED and GREEN LED. Original electronics have only RED LED and range setting is reversed (1 = longest, 8 = shortest)

BATTERY REPLACEMENT

Replace battery when RED LED indicator flashes each time faucet is in use or when faucet stops functioning.

Step 1

Close supply stop(s).

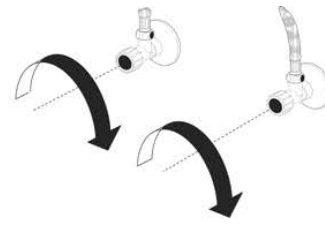

Step 2

Loosen screw with hex wrench.

Remove throat plate. Disconnect electrical lead at connector if required.



Step 3

Remove battery cover using a No. 1 Phillips head screwdriver. Remove old battery. Dispose of properly.

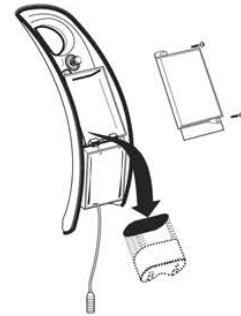

Step 4

Wait three (3) minutes before inserting new battery.



Step 5

Insert a new 6 volt type 2CR5 lithium battery. The RED LED will flash for one (1) minute.

Reinstall battery cover.

Reconnect electrical lead at connector if previously disconnected. Reinstall throat plate.

If LED doesn't flash or if it just lights up, remove the battery. Wait three (3) minutes, then reinsert the battery.

If water flows continuously after inserting the new battery and opening the supply stops, remove the battery. Wait three (3) minutes, then reinsert the battery.

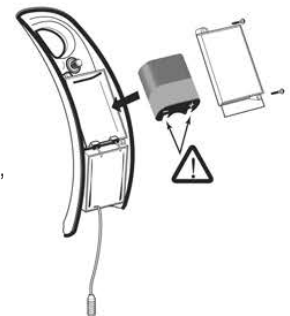

Step 6

Open supply stops.

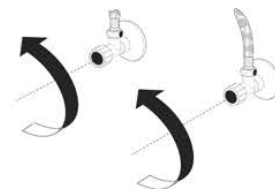

Optima® EAF-150

SERVICE OPERATION

Prepare for operation

A. Press the button once.

B. Remove sticker.

C. Water will flow 4 seconds

D. Wait 10 seconds, then the faucet is ready for use.

If waterflow DOES NOT start after removing the sticker and the RED LED within the sensor flashes continue with the following procedure!!

A. Press the button once.

B. Hold a white sheet of paper 1.5" (40 mm) in front of sensor until water flows for 4 seconds

C. Remove paper.

D. Wait 10 seconds, then the faucet is ready for use.

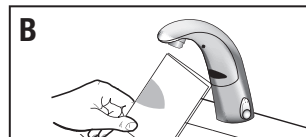
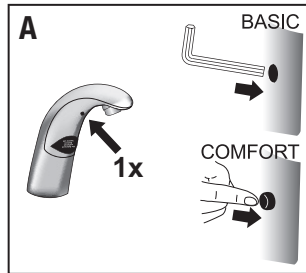
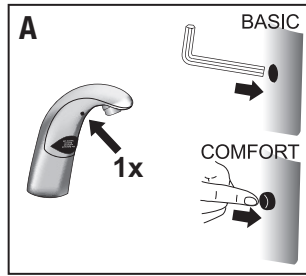

TROUBLESHOOTING GUIDE

1. Faucet DOES NOT function.

- A. Adhesive packaging label affixed over sensor eye. Remove adhesive label from sensor eye.
- B. "Permanent Off" activated. Press button on faucet throat one time.

2. Faucet delivers water in an uncontrolled manner.

- A. Faucet is not working properly. Contact Sloan Technical Support.

3. Faucet DOES NOT deliver any water when sensor is activated. INDICATOR: Solenoid valve produces an audible "CLICK."

- A. Water supply stop(s) closed. Open water supply stop(s).
- B. Water supply stop strainer(s) clogged. Clean water supply stop strainer(s).

INDICATOR: Solenoid valve DOES NOT produce an audible "CLICK."

- A. Battery low (EAF-150 Models). Replace battery (refer to battery replacement).

4. Faucet delivers only a slow flow or dribble when sensor is activated.

- A. Water supply stop(s) are partially closed. Completely open water supply stop(s).
- B. Water supply stop strainer(s) clogged. Remove, clean, and reinstall water supply stop strainer(s). Replace strainer(s) if required.
- C. Aerator is clogged. Remove, clean, and reinstall aerator. Replace aerator if required.
- D. Faucet is not working properly. Contact Sloan Technical Support.

5. Faucet DOES NOT stop delivering water or continues to drip after user is no longer detected.

- A. Faucet is not working properly. Contact Sloan Technical Support.

6. i.q.-cliq DOES NOT function (-IC models only)

- A. Button is not working properly. Contact Sloan Technical Support.

7. The water temperature is too hot or too cold on a faucet connected to hot and cold supply lines.

- A. Supply stops are not adjusted properly. Adjust supply stops.
- B. For models with integral mixing valve – mixing valve is set improperly for the water temperature desired. Rotate mixing valve handle clockwise to decrease water temperature or counterclockwise to increase water temperature.

CARE AND CLEANING

DO NOT USE abrasive or chemical cleaners (including chlorine bleach) to clean faucets that may dull the luster and attack the chrome or special decorative finishes. Use **ONLY** mild soap and water, then wipe dry with clean cloth or towel.

While cleaning the bathroom tile, protect the faucet from any splattering of cleaner. Acids and cleaning fluids will discolor or remove chrome plating.

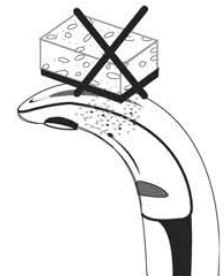

When assistance is required, please contact Sloan Technical Support at: 1-888-SLOAN-14 (1-888-756-2614).