



SAIT



2010-2011

 UNITED
ABRASIVES, INC.

SAIT

GRINDING - PG. 7

Grinding Wheels (1/4" Thick)



Introduction Pg 7
 Type 27 8-14
 Type 28 15-17

Pipeline Wheels (1/8" Thick)



Introduction Pg 23
 1/8" Wheels 24-25

Contaminant-Free Wheels



XA24Q (1/4") Pg 12
 XA24Q (1/8") 37
 XA46R (1/16" Cutting) 31

Flexible Grinding/Blending



Type 29 Wheels Pg 18

Cup Stones



Type 11 Pg 20-21

Cones, Plugs & Mounted Points



Type 16, 17, 18 Pg 19
 Type A, B, W 22

Hand and Floor Rubs



Plain, Fluted,
 Handle, Scored Pg 60

Bench Wheels



A, GC Pg 61

Cotton Fiber



Introduction Pg 56
 Cotton Fiber 57-59

Wire Brushes & Carbide Burs



Introduction Pg 129-130
 Wire Brushes 131-137
 Carbide Burs 138-139

CUTTING - PG. 26

.045" Cutting Wheels



Type 27 Pg 28-29
 Type 1 30-31, 38
 Type 1 Contaminant-Free
 1/16" 31

.090" Cutting/Notching Wheels



Type 27 Pg 32-33
 Type 1 34

3/32" & 1/8" Cutting Wheels



Type 27 Pg 35-37

Thin High Speed Cut-Off



.035", 1/16" & 1/8" Pg 38-39

Chop Saw Wheels



Chop Saw Pg 41-43

Portable Saw Cut-Off Wheels



Type 1 (4-1/2" - 9") Pg 40
 Type 1 (12" - 16") 44-46

Stationary Saw Wheels



Stationary Saw Pg 48-49

Street Saw Wheels



Street Saw Pg 47

Metal-Cutting Carbide Blades



Introduction Pg 50
 Carbide Blades 51-53

Diamond



Diamond Pg 54-55

Grinding & Cutting

Fiber Discs



Introduction Pg 71
Fiber Discs 72-76

Flap Discs



Introduction Pg 88-89
Ovation® 90-91
Saitlam™/Saitlam K™ 94
Saitlam F™ 93
Saitlam™ UK, UP, PN 92

Belts



Introduction Pg 64-65
Belt Specifications 66-69
Custom Belts 70

Laminated Discs



SAIT-LOK™ Pg 77-79
SAIT-LOK-R™

Paper Discs



Introduction Pg 80
PSA Disc Rolls 81
PSA Disc Individual 82-83
Hook & Loop 84-85

Cloth Discs



Introduction Pg 80
Zirconium 86
Aluminum Oxide 87

SAIT-PAK™



SAIT-PAK™ Pg 140

Flap Wheels



Small Diameter Pg 95
Large Diameter 96

Sheets



Introduction Pg 97
Cloth 98
Paper 98-99
Fileboard 100-101
Saitscreen™/Drywall 102
Sanding Sponges 103

Shop Rolls



Industrial/Handy Pg 104
Mini/Custom 105
Saitscreen™/Plumber 106

Specialties



Spiral Bands Pg 107
Cartridge Rolls 108-109
Cross Pads 110
Square Pads 110

Floor Sanding



Sheets/Belts Pg 111
Discs 112
Rolls 113
Pads 114-115

Accessory Items



Introduction Pg 141
Accessories 142-148

Non-Woven







Introduction Pg 116
Hand Pads 117
Belts 118
Discs 119-120
SAIT-Strip™ Products 121
Flap Brushes 122
Interleaf Wheels 123
Unitized Wheels/Type 27 124-125
Convolute Wheels 126
Sand-Light™ Blending Discs 127
Buffing Pads/Compounds 128



How To Use THIS CATALOG

COLOR CODING SYSTEM

- Uniform color identification throughout our bonded abrasives section and on our product labels.
- Quickly recognize the right product for the type of material you are working with.

| PRODUCT | COLOR CODING TO MATERIAL | PRODUCT | COLOR CODING TO MATERIAL |
|--|--------------------------|---|--------------------------|
|  | METAL |  | ALUMINUM |
|  | STAINLESS |  | CONCRETE |

TECHNICAL & REFERENCE MATERIAL - PG. 149

| | |
|---|-----------|
| Anatomy of a Wheel | 157 |
| Bonded Abrasives Application Chart | 162-163 |
| Coated Abrasives Application Chart | 164-165 |
| Coated Abrasives Information and Manufacturing | 159-161 |
| Common Occurrences With Grinding/Cutting Applications | 158 |
| How a Wheel Works | 158 |
| Index by Product Description and Number | 166-169 |
| Marking System | 155 |
| Metal-Cutting Carbide Blade Technical Data | 53 |
| Promotional Information and Displays | 149-151 |
| Safety Information | 153 |
| Storage and Handling | 156 & 161 |
| Super-Lock™ Hub | 154 |
| Wheel Configurations | 155 |
| Wheel Label Example | 156 |

- Privately held company established in 1970.
- Relationship with SAIT, an Italian corporation founded in 1953, began as we first manufactured coated abrasive belts.
- By 1975, we had expanded our production to include bonded abrasives.
- Well known worldwide for quality, consistency, and the highest levels of service.
- One of the largest and leading manufacturers of abrasive products in the world for both bonded and coated.
- Only premium raw materials are used.
- Demand consistent manufacturing operations and have the most rigorous quality control testing in the industry.
- EVERY order is a RUSH delivery! From phone order to truck in minutes!



PRODUCT WARRANTY

United Abrasives, Inc. warrants that all industrial products it manufactures will be as represented in its catalog and will be free from defects in material and workmanship under normal use for which the product was intended if, but only if, it has been properly stored and used. Our obligation under this Warranty shall be limited to either the exchange of any product proven to be defective under normal use or to refund the purchase price thereof, at our option, within six months from the date of purchase by the original purchaser. The term "original purchaser", as used in this Warranty, shall be deemed to mean that person or company to whom the product was originally sold. This remedy is purchaser's exclusive remedy against United Abrasives, Inc. for any damages to either person or property caused by any defect or other failure in the product. Said refund or exchange shall constitute a fulfillment of any and all liabilities of United Abrasives, Inc. with respect to the quality of the product sold by it.











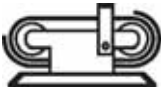

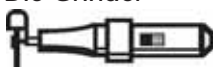



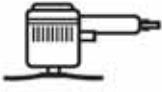

THIS WARRANTY IS EXPRESSLY IN LIEU OF ALL OTHER WARRANTIES EXPRESSED OR IMPLIED, INCLUDING THE WARRANTIES OF MERCHANTABILITY AND FITNESS FOR USE AND OF ALL OTHER OBLIGATIONS OR LIABILITIES ON OUR PART, AND WE NEITHER ASSUME NOR AUTHORIZE ANY OTHER PERSON TO ASSUME FOR US, ANY OTHER LIABILITY IN CONNECTION WITH THE SALE OF OUR PRODUCTS. THIS WARRANTY SHALL NOT APPLY TO ANY PRODUCT SOLD BY US WHICH HAS BEEN SUBJECT TO ACCIDENT, NEGLIGENCE, ALTERATION, ABUSE, OR MISUSE. WE MAKE NO WARRANTY WITH RESPECT TO ACCESSORIES OR PARTS EMPLOYED BY THE USER WITH OUR PRODUCT WHICH WERE NOT SUPPLIED BY UNITED ABRASIVES, INC. UNDER NO CIRCUMSTANCES IS UNITED ABRASIVES, INC. LIABLE FOR ANY DIRECT INCIDENTAL, SPECIAL, OR CONSEQUENTIAL DAMAGES (INCLUDING LOST PROFITS) IN ANY WAY RELATING TO THE PRODUCTS SOLD BY UNITED ABRASIVES, INC.

All products listed in this catalog must be used in accordance with the safety regulations set by OSHA, by the directive described by the American National Safety Institute B7.1 ("Safety Requirements for the Use, Care and Protection of Abrasive Wheels") and by the American Brush Manufacturers Association. The user of any United Abrasives, Inc. product should be thoroughly familiar with the above safety rules and regulations before use of the product.



Products By Tool Index

The tool graphic found on each page of the catalog represents the appropriate tool the product can be used on. These icons are also located on our product and box labels for easy identification.

| Tool Icon | Page # | Tool Icon | Page # |
|---|--|---|-------------|
|  | 8-18, 20-21, 24-25, 28-38, 40, 54-55, 57-58, 72-76, 91-95, 120-121, 124, 128, 131-134, 137 |  | 66-69, 118 |
|  | 59, 77-79, 119-121, 127-128 |  | 66, 69, 118 |
|  | 19, 22, 39, 57, 59, 107-110, 121, 123, 125, 135, 137-139 |  | 111-115 |
|  | 30-31, 34, 38, 40, 51-52, 54-55 |  | 127-128 |
|  | 42-43 |  | 81-87, 120 |
|  | 48-49 |  | 112 |
|  | 44-46, 54-55 |  | 100-101 |
|  | 47, 135 |  | 102 |
|  | 61, 126-127, 131, 137 |  | 66, 118 |
|  | 66-68, 118 |  | 51-52 |
|  | 51-52 |  | 51-52 |

GRINDING INTRODUCTION



- This section contains ten 1/4" thick grinding specifications (Type 27, 28 and 29).
- You will also find Cones, Plugs, Cup Stones, Mounted Points and Challenger II.

TYPE 27



PAGES 8-11

- A24N**
Fast Grinding
- A24R**
Long Life
- A24T**
Edge Grinding



- A24Turbo™**
Smooth, Edge Grinding
Better Control
Long Life



- Sait Z-tech™**
Extremely Fast Stock
Removal
Special Zirconium
Grain

Can be used on
Stainless Steel



- A46N**
Extremely Fast Stock
Removal

Non-loading Formula

TYPE 27



PAGES 12-22

- XA24Q**
Contaminant Free
Grinding

Free of Iron, Sulphur &
Chlorine



- Saitech Attacker®**
Fast Grinding

**Saitech
Ultimate
Performance™**
Long Life



- C24N**
General Purpose
Grinding on Masonry,
Concrete and Stone



Grinding

1/4"

TYPE 27 Depressed Center Wheels

GRINDING

GENERAL PURPOSE



A24N - Fast Grinding

- Aluminum oxide grain
- Soft bond for fast stock removal

METAL Ferrous Metals (iron, steel, welds, etc.)

STAINLESS Low grade stainless steel

A24R - Long Life

- Aluminum oxide grain; our most popular wheel
- For general purpose grinding
- Longer life for fewer wheel changes

METAL Ferrous Metals (iron, steel, welds, etc.)

A24T - Edge Grinding

- Aluminum oxide grain
- Hard bond designed for edge and bevel grinding and other applications where a harder wheel is preferred
- Longer life for fewer wheel changes

METAL Ferrous Metals (iron, steel, welds, etc.)



Quick Tip
The "softer" a grinding wheel is (A24N) the faster it will remove metal.

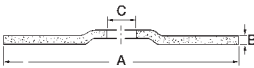

| Size | | | Max RPM | Grades Available | | | Qty Per Box | Qty Per Ctn | Lbs Per Box |
|--------|---------|--------|---------|------------------|-------|-------|-------------|-------------|-------------|
| A Dia. | B Width | C Bore | | Part Number | | | | | |
| 3 | 3/16 | 3/8 | 18,000 | 20001 | - | - | 25 | 100 | 3 |
| 3 | 1/4 | 3/8 | 18,000 | 20002 | 20005 | - | 25 | 100 | 4 |
| 4 | 3/16 | 3/8 | 13,500 | 20010 | - | - | 25 | 100 | 6 |
| 4 | 1/4 | 3/8 | 13,500 | 20012 | 20019 | - | 25 | 100 | 7 |
| 4 | 1/4 | 5/8 | 13,500 | 20015 | 20013 | - | 25 | 100 | 7 |
| 4-1/2 | 3/16 | 7/8 | 13,300 | 20050 | - | - | 25 | 100 | 8 |
| 4-1/2 | 3/16 | 5/8-11 | 13,300 | 20150 | - | - | 10 | 40 | 5 |
| 4-1/2 | 1/4 | 7/8 | 13,300 | 20060 | 20063 | 20065 | 25 | 100 | 9 |
| 4-1/2 | 1/4 | 5/8-11 | 13,300 | 20160 | 20163 | 20165 | 10 | 40 | 6 |
| 5 | 1/4 | 7/8 | 12,200 | 20070 | 20073 | 20075 | 25 | 100 | 11 |
| 5 | 1/4 | 5/8-11 | 12,200 | 20170 | 20173 | 20175 | 10 | 40 | 6 |
| 6 | 1/4 | 7/8 | 10,200 | 20078 | 20079 | 20280 | 25 | 50 | 18 |
| 6 | 1/4 | 5/8-11 | 10,200 | 20178 | 20076 | 20180 | 10 | 40 | 10 |
| 7 | 1/4 | 7/8 | 8,500 | 20081 | 20080 | 20285 | 25 | 50 | 24 |
| 7 | 1/4 | 5/8-11 | 8,500 | 20085 | 20086 | 20185 | 10 | 40 | 14 |
| 9 | 1/4 | 7/8 | 6,600 | 20091 | 20090 | 20295 | 25 | 50 | 42 |
| 9 | 1/4 | 5/8-11 | 6,600 | 20095 | 20096 | 20195 | 10 | 40 | 20 |

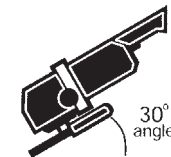

Angle Grinder



5/8-11 Super-Lock™ Hub

Tech INFO

- Virgin aluminum oxide grain assures consistent high stock removal for tough applications
- All sizes are made with uniform grain throughout, no filler grain used in the backing
- All wheels internally reinforced with the highest quality fiberglass for maximum safety
- Super-Lock™ Hub on all 5/8-11 threaded wheels is the safest, vibration-free design

TYPE 27 Depressed Center Wheels

Grinding 1/4"

GRINDING

SPECIALTY

A24Turbo™ - Hard Edge

- Special combination aluminum oxide grain
- Hard bond system for all edge and tough applications requiring a harder wheel
- Very hard edge which breaks down evenly for smooth operation
- Very long life for fewer wheel changes

METAL Ferrous Metals (iron, steel, welds, etc.)

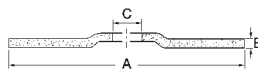

5/8-11 Super-Lock™ Hub

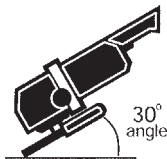

Angle Grinder

| Size | | | Max RPM | Part Number | Qty Per Box | Qty Per Ctn | Lbs Per Box |
|--------|---------|--------|---------|-------------|-------------|-------------|-------------|
| A Dia. | B Width | C Bore | | | | | |
| 4-1/2 | 1/4 | 7/8 | 13,300 | 25803 | 25 | 100 | 9 |
| 4-1/2 | 1/4 | 5/8-11 | 13,300 | 25813 | 10 | 40 | 6 |
| 5 | 1/4 | 7/8 | 12,200 | 25805 | 25 | 100 | 11 |
| 5 | 1/4 | 5/8-11 | 12,200 | 25815 | 10 | 40 | 6 |
| 6 | 1/4 | 7/8 | 10,200 | 25806 | 25 | 50 | 17 |
| 6 | 1/4 | 5/8-11 | 10,200 | 25816 | 10 | 40 | 10 |
| 7 | 1/4 | 7/8 | 8,500 | 25807 | 25 | 50 | 24 |
| 7 | 1/4 | 5/8-11 | 8,500 | 25817 | 10 | 40 | 9 |
| 9 | 1/4 | 7/8 | 6,600 | 25809 | 25 | 50 | 39 |
| 9 | 1/4 | 5/8-11 | 6,600 | 25819 | 10 | 40 | 19 |



- Virgin aluminum oxide grain assures consistent high stock removal for tough applications
- All sizes are made with uniform grain throughout, no filler grain used in the backing
- All wheels internally reinforced with the highest quality fiberglass for maximum safety
- Super-Lock™ Hub on all 5/8-11 threaded wheels is the safest, vibration-free design

Grinding 1/4"

TYPE 27 Depressed Center Wheels

GRINDING

HIGH PERFORMANCE



Z24R - Zirconium

- Tough zirconium grain
- High performance grinding for the toughest applications

METAL Ferrous metals (iron, steel, welds)

STAINLESS Stainless steel, high tensile alloys

HIGH PERFORMANCE

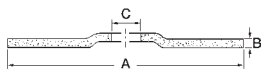

| Size | | | Max RPM | Part Number | Qty Per Box | Qty Per Ctn | Lbs Per Box |
|--------|---------|--------|---------|-------------|-------------|-------------|-------------|
| A Dia. | B Width | C Bore | | | | | |
| 4 | 1/4 | 5/8 | 13,500 | 22599 | 25 | 100 | 7 |
| 4-1/2 | 1/4 | 7/8 | 13,300 | 22600 | 25 | 100 | 9 |
| 4-1/2 | 1/4 | 5/8-11 | 13,300 | 22610 | 10 | 40 | 6 |
| 5 | 1/4 | 7/8 | 12,200 | 22602 | 25 | 100 | 12 |
| 5 | 1/4 | 5/8-11 | 12,200 | 22612 | 10 | 40 | 6 |
| 6 | 1/4 | 7/8 | 10,200 | 22603 | 25 | 50 | 20 |
| 6 | 1/4 | 5/8-11 | 10,200 | 22613 | 10 | 40 | 9 |
| 7 | 1/4 | 7/8 | 8,500 | 22604 | 25 | 50 | 25 |
| 7 | 1/4 | 5/8-11 | 8,500 | 22614 | 10 | 40 | 14 |
| 9 | 1/4 | 7/8 | 6,600 | 22606 | 25 | 50 | 42 |
| 9 | 1/4 | 5/8-11 | 6,600 | 22616 | 10 | 40 | 21 |

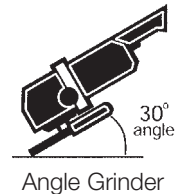

- The highest quality zirconium grain
- All sizes made with uniform grain throughout, no filler grain used
- Super-Lock™ Hub on all 5/8-11 threaded arbors is the safest, vibration-free design

TYPE 27 Depressed Center Wheels

Grinding
1/4"

GRINDING

ALUMINUM

A46N - Aluminum

- Aluminum oxide grain
- Soft bond for aggressive removal of material without loading
- Outlasts competition by as much as 40%

ALUMINUM Non-ferrous metals (aluminum, copper, brass, etc.)



See pages 56-59 for Cotton Fiber grinding and blending products for aluminum

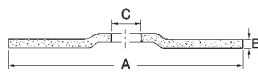

| Size | | | Max RPM | Part Number | Qty Per Box | Qty Per Ctn | Lbs Per Box |
|--------|---------|--------|---------|-------------|-------------|-------------|-------------|
| A Dia. | B Width | C Bore | | | | | |
| 4 | 1/4 | 5/8 | 13,500 | 20018 | 25 | 100 | 7 |
| 4-1/2 | 1/4 | 7/8 | 13,300 | 20062 | 25 | 100 | 9 |
| 4-1/2 | 1/4 | 5/8-11 | 13,300 | 20162 | 10 | 40 | 6 |
| 5 | 1/4 | 7/8 | 12,200 | 20072 | 25 | 100 | 11 |
| 5 | 1/4 | 5/8-11 | 12,200 | 20172 | 10 | 40 | 6 |
| 7 | 1/4 | 7/8 | 8,500 | 20083 | 25 | 50 | 24 |
| 7 | 1/4 | 5/8-11 | 8,500 | 20088 | 10 | 40 | 13 |
| 9 | 1/4 | 7/8 | 6,600 | 20093 | 25 | 50 | 41 |
| 9 | 1/4 | 5/8-11 | 6,600 | 20098 | 10 | 40 | 20 |

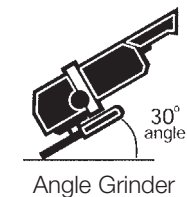

Tech INFO

- Special aluminum oxide formulation prevents "loading" on soft (non-ferrous) metals
- All sizes internally reinforced with the highest quality fiberglass for maximum safety and performance
- Super-Lock™ Hub on all 5/8-11 threaded wheels is the safest, vibration-free design

Grinding

1/4"

TYPE 27 Depressed Center Wheels

GRINDING

CONTAMINANT-FREE/STAINLESS STEEL



XA24Q - Contaminant-Free

- Specially formulated for nuclear and food processing plants
- Free of iron, chlorine and sulphur compounds (Fe + Cl + S <0.1%)

STAINLESS Stainless steel and other high tensile alloys

METAL Ferrous metals (iron, steel, welds, etc.)

- Available in 1/8" for pipeline work
(for more information see page 37)
- Will not contaminate stainless steel

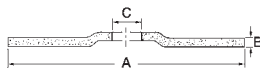

| Size | | | Max RPM | Part Numbers | Qty Per Box | Qty Per Ctn | Lbs Per Box |
|--------|---------|--------|---------|--------------|-------------|-------------|-------------|
| A Dia. | B Width | C Bore | | | | | |
| 4-1/2 | 1/4 | 7/8 | 13,300 | 24210 | 25 | 100 | 9 |
| 5 | 1/4 | 7/8 | 12,200 | 24215 | 25 | 100 | 9 |
| 6 | 1/4 | 7/8 | 10,200 | 24220 | 25 | 50 | 20 |
| 7 | 1/4 | 7/8 | 8,500 | 24225 | 25 | 50 | 25 |
| 9 | 1/4 | 7/8 | 6,600 | 24230 | 25 | 50 | 49 |

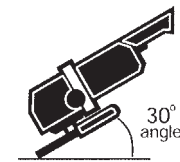

Angle Grinder



- Specially formulated for contaminant-free stock removal on stainless steel
- All sizes reinforced with the highest quality fiberglass for maximum safety and performance

TYPE 27

Saitech High Performance Wheels

Grinding
1/4"

GRINDING

HIGH PERFORMANCE/STAINLESS STEEL

Saitech Attacker®

- High performance, ceramic aluminum oxide grain
- Very uniform, high density grain structure is extremely durable and self sharpening for long life and cooler cut
- Extremely fast stock removal on hard metals with minimal pressure

STAINLESS Stainless steel and other high tensile alloys

METAL Ferrous metals (iron, steel, welds, etc.)

Saitech Ultimate Performance™

- High performance, ceramic aluminum oxide grain
- Very uniform, high density grain structure is extremely durable and self sharpening for long life and cooler cut
- Combines fast stock removal with long life

STAINLESS Stainless steel and other high tensile alloys

METAL Ferrous metals (iron, steel, welds, etc.)

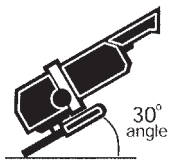
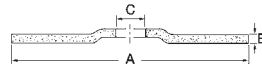

Angle Grinder

| Size | | | Max RPM | Grades Available | | | Qty Per Box | Qty Per Ctn | Lbs Per Box |
|--------|---------|--------|---------|------------------|----------|----|-------------|-------------|-------------|
| A Dia. | B Width | C Bore | | Part Numbers | | | | | |
| | | | | Attacker® | Saitech™ | UP | | | |
| 3 | 3/16 | 3/8 | 18,000 | - | 20101 | | 25 | 100 | 3 |
| 3 | 1/4 | 3/8 | 18,000 | - | 20102 | | 25 | 100 | 4 |
| 4 | 3/16 | 3/8 | 13,500 | - | 20103 | | 25 | 100 | 5 |
| 4 | 1/4 | 3/8 | 13,500 | - | 20112 | | 25 | 100 | 7 |
| 4 | 1/4 | 5/8 | 13,500 | 20041 | 20014 | | 25 | 100 | 8 |
| 4-1/2 | 1/4 | 7/8 | 13,300 | 20046 | 20064 | | 25 | 100 | 11 |
| 4-1/2 | 1/4 | 5/8-11 | 13,300 | 20146 | 20164 | | 10 | 40 | 6 |
| 5 | 1/4 | 7/8 | 12,200 | 20047 | 20074 | | 25 | 100 | 13 |
| 5 | 1/4 | 5/8-11 | 12,200 | 20147 | 20174 | | 10 | 40 | 8 |
| 7 | 1/4 | 7/8 | 8,500 | 20048 | 20084 | | 25 | 50 | 28 |
| 7 | 1/4 | 5/8-11 | 8,500 | 20148 | 20089 | | 10 | 40 | 14 |
| 9 | 1/4 | 7/8 | 6,600 | 20049 | 20094 | | 25 | 50 | 43 |
| 9 | 1/4 | 5/8-11 | 6,600 | 20149 | 20099 | | 10 | 40 | 21 |



- Manufactured with patented 3M™ Cubitron™ grain to outlast standard aluminum oxide wheels
- Special bonding formula allows for very fast stock removal on many types of metals
- Designed to provide very long life for fewer wheel changes and less downtime
- All sizes reinforced with the highest quality fiberglass for maximum safety and performance

3M and Cubitron are trademarks of 3M

Grinding 1/4"

TYPE 27 Depressed Center Wheels

GRINDING

CONCRETE



C24N - Concrete

- Silicon carbide grain
- Soft bond for fast stock removal

CONCRETE Masonry, concrete, stone

METAL Cast iron and other ferrous metals



Quick Tip

Use the C24N wheel on hard to grind metal like cast iron

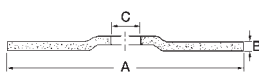

| Size | | | Max RPM | Part Number | Qty Per Box | Qty Per Ctn | Lbs Per Box |
|--------|---------|--------|---------|-------------|-------------|-------------|-------------|
| A Dia. | B Width | C Bore | | | | | |
| 4 | 1/4 | 5/8 | 13,500 | 20017 | 25 | 100 | 6 |
| 4-1/2 | 1/4 | 7/8 | 13,300 | 20061 | 25 | 100 | 8 |
| 4-1/2 | 1/4 | 5/8-11 | 13,300 | 20161 | 10 | 40 | 6 |
| 5 | 1/4 | 7/8 | 12,200 | 20071 | 25 | 100 | 10 |
| 5 | 1/4 | 5/8-11 | 12,200 | 20171 | 10 | 40 | 6 |
| 7 | 1/4 | 7/8 | 8,500 | 20082 | 25 | 50 | 24 |
| 7 | 1/4 | 5/8-11 | 8,500 | 20087 | 10 | 40 | 12 |
| 9 | 1/4 | 7/8 | 6,600 | 20092 | 25 | 50 | 33 |
| 9 | 1/4 | 5/8-11 | 6,600 | 20097 | 10 | 40 | 7 |



5/8-11 Super-Lock™ Hub

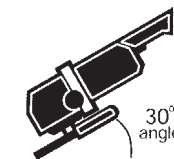

Angle Grinder



- Special Silicon Carbide grain formula is excellent for grinding masonry, concrete, stone and aggregate
- All sizes reinforced with the highest quality fiberglass for maximum safety and performance
- Super-Lock™ Hub on all 5/8-11 threaded wheels is the safest, vibration-free design

TYPE 28 Depressed Center Wheels

Grinding 1/4"

GRINDING

GENERAL PURPOSE

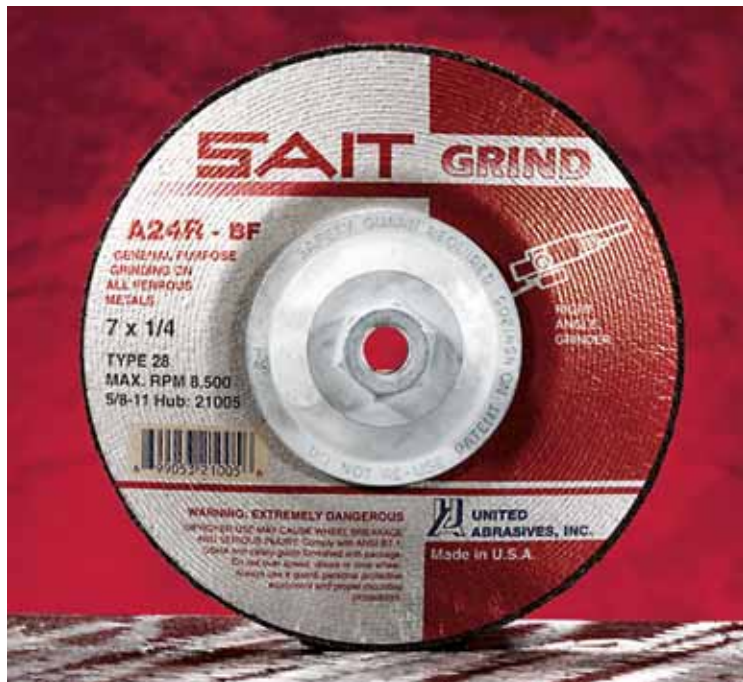

A24N - Fast Grinding

- Aluminum oxide grain
- Soft bond for fast stock removal

METAL Ferrous metals (iron, steel, welds, etc.)

STAINLESS Low-grade stainless steel

A24R - Long Life

- Aluminum oxide grain
- Medium bond for longer life and fewer wheel changes

METAL Ferrous metals (iron, steel, welds, etc.)

QT *Quick Tip*
Use this saucer shape for uniform grinding of large flat surfaces.

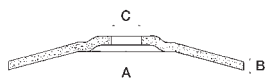

| Size | | | Max RPM | Grades Available | | Qty Per Box | Qty Per Ctn | Lbs Per Box |
|-------|-------|--------|---------|------------------|-------|-------------|-------------|-------------|
| A | B | C | | Part Number | | | | |
| Dia. | Width | Bore | | A24N | A24R | | | |
| 4-1/2 | 1/4 | 7/8 | 13,300 | 21020 | 21021 | 25 | 100 | 9 |
| 4-1/2 | 1/4 | 5/8-11 | 13,300 | 21025 | 21026 | 10 | 40 | 6 |
| 7 | 1/4 | 7/8 | 8,500 | 21001 | 21000 | 25 | 50 | 23 |
| 7 | 1/4 | 5/8-11 | 8,500 | 21004 | 21005 | 10 | 40 | 13 |
| 9 | 1/4 | 7/8 | 6,600 | 21011 | 21010 | 25 | 50 | 38 |
| 9 | 1/4 | 5/8-11 | 6,600 | 21014 | 21015 | 10 | 40 | 19 |

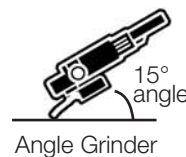

- Type 28 saucer shape (see diagram above) allows greater surface area coverage and provides the operator with greater grind visibility
- Additional fiberglass reinforcement for maximum safety in high lateral pressure applications
- Super-Lock™ Hub on all 5/8-11 threaded wheels is the safest, vibration-free design

Grinding

1/4"

TYPE 28 Saitech High Performance Wheels

GRINDING

HIGH PERFORMANCE/STAINLESS STEEL

Saitech Ultimate Performance™

- High performance, ceramic aluminum oxide grain
- Very uniform, high density grain structure is extremely durable and self sharpening for long life and cooler cut
- Exclusive formula with patented 3M™ Cubitron™ grain
- Combines maximum material removal with long life

STAINLESS Stainless steel

METAL Ferrous metals (iron, steel, welds, etc.)

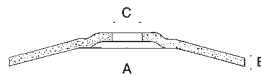

| Size | | | Max RPM | Part Number | Qty Per Box | Qty Per Ctn | Lbs Per Box |
|--------|---------|--------|---------|-------------|-------------|-------------|-------------|
| A Dia. | B Width | C Bore | | | | | |
| 7 | 1/4 | 7/8 | 8,500 | 21084 | 25 | 50 | 23 |
| 7 | 1/4 | 5/8-11 | 8,500 | 21089 | 10 | 40 | 12 |
| 9 | 1/4 | 7/8 | 6,600 | 21094 | 25 | 50 | 34 |
| 9 | 1/4 | 5/8-11 | 6,600 | 21099 | 10 | 40 | 19 |

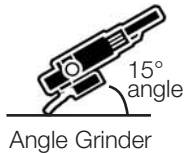

Tech INFO

- Type 28 saucer shape (see diagram above) allows greater surface area coverage and provides the operator with greater grind visibility
- Patented 3M™ Cubitron™ grain formulation outlasts standard aluminum oxide wheels
- Additional fiberglass reinforcement for maximum safety in high lateral pressure applications
- Super-Lock™ Hub on all 5/8-11 threaded wheels is the safest, vibration-free design

TYPE 28 Depressed Center Wheels

Grinding
1/4"

GRINDING

CONCRETE

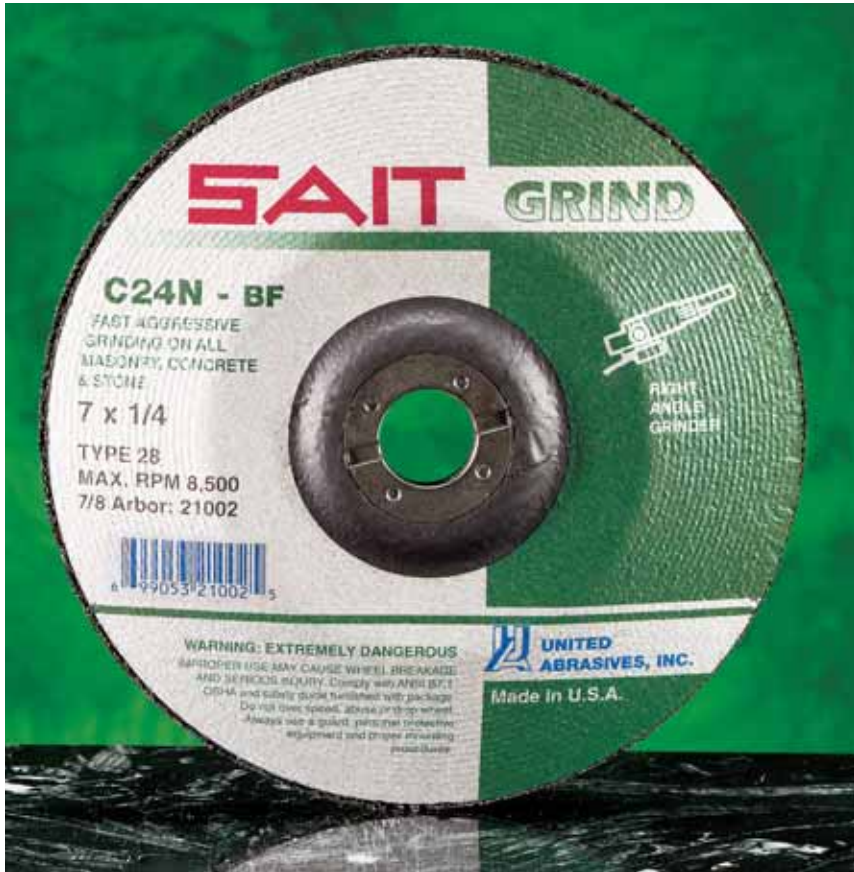

C24N - Concrete

- Silicon carbide grain
- Soft bond for fast stock removal

CONCRETE Masonry, concrete, stone, brick

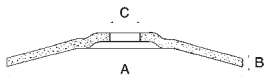

| Size | | | Max RPM | Part Number | Qty Per Box | Qty Per Ctn | Lbs Per Box |
|--------|---------|--------|---------|-------------|-------------|-------------|-------------|
| A Dia. | B Width | C Bore | | | | | |
| 7 | 1/4 | 7/8 | 8,500 | 21002 | 25 | 50 | 20 |
| 7 | 1/4 | 5/8-11 | 8,500 | 21006 | 10 | 40 | 11 |
| 9 | 1/4 | 7/8 | 6,600 | 21012 | 25 | 50 | 32 |
| 9 | 1/4 | 5/8-11 | 6,600 | 21016 | 10 | 40 | 16 |



- Special silicon carbide grain formula is excellent for grinding masonry, concrete, stone and aggregate
- Type 28 saucer shape (see diagram above) allows greater surface area coverage and provides the operator with greater grind visibility
- Additional fiberglass reinforcement for maximum safety in high lateral pressure applications
- Super-Lock™ Hub on all 5/8-11 threaded wheels is the safest, vibration-free design

Flexible Grinding/Blending Wheels

GRINDING

SPECIALTY

PROPER CLAMPING PROCEDURES

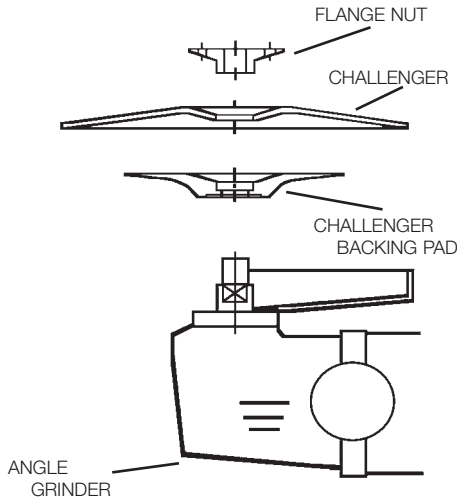

Packaging

Each box of 25 supplied with a backing pad and one 5/8-11 nut
 Additional pad assembly:
 4-1/2" & 5" - #95245
 7" - #95247

For additional pads & nuts see page 142

Challenger II™

- Aluminum oxide grain
- Open pattern on wheel for cool grinding and blending
- Safe for use in the nuclear industry

METAL Steel, iron, aluminum, brass, bronze

STAINLESS Stainless steel

CONCRETE Also for use on plastic, fiberglass, masonry

WOOD



Quick Tip

Use Challenger II™ for longer life in aggressive applications.

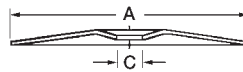
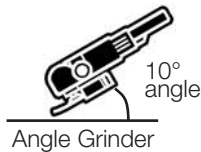

| Size | | Max RPM | Part Numbers/Grits | | | | Qty Per Box | Lbs Per Box |
|--------|--------|---------|--------------------|-------|-------|-------|-------------|-------------|
| A Dia. | C Bore | | Challenger II™ | | | | | |
| 4-1/2 | 7/8 | 13,280 | - | 27500 | 27501 | 27502 | 25 | 6 |
| 5 | 7/8 | 12,200 | - | 27506 | 27507 | 27508 | 25 | 5 |
| 7 | 7/8 | 8,600 | 27510 | 27511 | 27512 | 27513 | 25 | 14 |

Tech INFO

- Type 29 shape (see diagram above) allows easy control in grinding and blending applications
- Honeycomb, dimpled pattern on face allows for greater cooling action and longer life
- Grind and blend welds in one-step, no need for multiple steps and products
- Available in many grits for all your grinding and blending needs

TYPE 16, 17, 18 Cones & Plugs

Grinding

GRINDING

GENERAL PURPOSE



Cones and Plugs

- Aluminum oxide grain
- For grinding and snagging in hard to reach areas
- Fast stock removal

METAL Ferrous metals
(iron, steel, welds, etc.)

Packaging
10 per box

Type 16 Cone

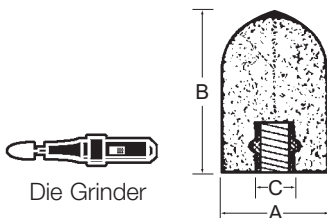

| Size | | | Grade Available | Max RPM | Part No. | Qty Per Box | Lbs Per Box |
|--------|----------|--------|-----------------|---------|----------|-------------|-------------|
| A Dia. | B Length | C Bore | | | | | |
| 1-1/4 | 3 | 3/8-24 | A16 | 29,000 | 25000 | 10 | 3 |
| 2 | 3 | 3/8-24 | A16 | 18,100 | 25005 | 10 | 6 |
| 2 | 3 | 5/8-11 | A16 | 18,100 | 25006 | 10 | 7 |
| 2-3/4 | 3-1/2 | 5/8-11 | A16 | 13,200 | 25008 | 10 | 13 |

Type 17 Cone

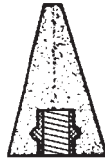

| | | | | | | | |
|-------|-------|--------|-----|--------|-------|----|---|
| 1-1/2 | 2-1/2 | 3/8-24 | A20 | 24,100 | 25101 | 10 | 3 |
| 1-1/2 | 2-1/2 | 5/8-11 | A20 | 24,100 | 25102 | 10 | 3 |
| 1-1/2 | 3 | 3/8-24 | A16 | 24,100 | 25103 | 10 | 3 |
| 1-1/2 | 3 | 5/8-11 | A16 | 24,100 | 25104 | 10 | 4 |
| 2 | 3 | 3/8-24 | A16 | 18,100 | 25105 | 10 | 6 |
| 2 | 3 | 5/8-11 | A16 | 18,100 | 25106 | 10 | 5 |

Type 18 Plug



| | | | | | | | |
|-------|-------|--------|-----|--------|-------|----|----|
| 1-1/2 | 2-1/2 | 3/8-24 | A20 | 24,100 | 25201 | 10 | 5 |
| 1-1/2 | 2-1/2 | 5/8-11 | A20 | 24,100 | 25202 | 10 | 5 |
| 1-1/2 | 3 | 3/8-24 | A16 | 24,100 | 25203 | 10 | 5 |
| 1-1/2 | 3 | 5/8-11 | A16 | 24,100 | 25204 | 10 | 6 |
| 2 | 3 | 3/8-24 | A16 | 18,100 | 25205 | 10 | 10 |
| 2 | 3 | 5/8-11 | A16 | 18,100 | 25206 | 10 | 11 |

Type 18R Plug



| | | | | | | | |
|-------|-------|--------|-----|--------|-------|----|---|
| 1-1/2 | 2-1/2 | 3/8-24 | A20 | 24,100 | 25301 | 10 | 5 |
| 1-1/2 | 2-1/2 | 5/8-11 | A20 | 24,100 | 25302 | 10 | 5 |
| 1-1/2 | 3 | 3/8-24 | A16 | 24,100 | 25303 | 10 | 6 |
| 1-1/2 | 3 | 5/8-11 | A16 | 24,100 | 25304 | 10 | 6 |
| 2 | 3 | 3/8-24 | A16 | 18,100 | 25305 | 10 | 8 |
| 2 | 3 | 5/8-11 | A16 | 18,100 | 25306 | 10 | 9 |



- Available in the most common application shapes
- Large grit size for heavy-duty grinding and snagging



Z16 - Zirconium

- Special Zirconium grain formulation
- Coarse grit and hard bond for the toughest grinding applications
- Outlasts standard Aluminum Oxide cup wheels 2:1

METAL Ferrous metals
STAINLESS Stainless steel

A16 - General Purpose

- Aluminum oxide grain
- Coarse grit wheel for tough grinding applications
- Excellent for cleaning castings, mold marks, removing flashing

METAL Ferrous metals

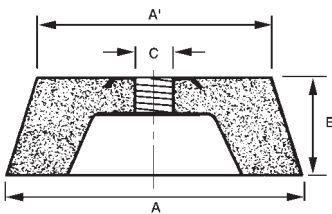

Available with an optional metal backing

| Size | | | | Grades Available | Max RPM | Part Number | MB* | Qty Per Box | Lbs Per Box |
|--------|---------|---------|--------|------------------|---------|-------------|-------|-------------|-------------|
| A Dia. | A' Dia. | B Width | C Bore | | | | | | |
| 4 | 3 | 2 | 5/8-11 | A16 | 9,050 | 26000 | 26003 | 12 | 25 |
| 5 | 4 | 2 | 5/8-11 | A16 | 7,250 | 26010 | 26013 | 6 | 20 |
| 5 | 4 | 2 | 5/8-11 | Z16 | 7,250 | 26050 | 26053 | 6 | 23 |
| 6 | 4-3/4 | 2 | 5/8-11 | A16 | 6,050 | 26020 | 26023 | 5 | 25 |
| 6 | 4-3/4 | 2 | 5/8-11 | Z16 | 6,050 | 26060 | 26063 | 5 | 25 |

MB* = metal backing



Angle Grinder



- Type 11 shape (see diagram above) provides maximum surface area coverage for grinding and cleaning applications
- Offered with a metal backed option for greater stability in high-pressure applications

TYPE 11 Cup Stones

Grinding

GRINDING

CONCRETE

C16 - Concrete

- Silicon carbide grain
- Coarse grit for tough grinding applications
- Excellent for cleaning castings, mold marks, and removing flashing

CONCRETE Masonry, concrete, stone

CA16 - Combination

- Combination of aluminum oxide and silicon carbide grains
- Excellent for cleaning castings, mold marks, and removing flashing

METAL Use on combination of ferrous
CONCRETE metals and/or concrete materials

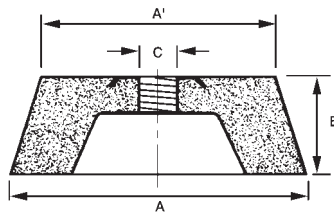

Available with an optional metal backing



Angle Grinder

| Size | | | | Grades Available | Max RPM | Part Number | MB* | Qty Per Box | Lbs Per Box |
|--------|---------|---------|--------|------------------|---------|-------------|-------|-------------|-------------|
| A Dia. | A' Dia. | B Width | C Bore | | | | | | |
| 4 | 3 | 2 | 5/8-11 | C16 | 9,050 | 26001 | 26004 | 12 | 21 |
| 4 | 3 | 2 | 5/8-11 | CA16 | 9,050 | 26002 | 26005 | 12 | 24 |
| 5 | 4 | 2 | 5/8-11 | C16 | 7,250 | 26011 | 26014 | 6 | 17 |
| 5 | 4 | 2 | 5/8-11 | CA16 | 7,250 | 26012 | 26015 | 6 | 19 |
| 6 | 4-3/4 | 2 | 5/8-11 | C16 | 6,050 | 26021 | 26024 | 5 | 20 |
| 6 | 4-3/4 | 2 | 5/8-11 | CA16 | 6,050 | 26022 | 26025 | 5 | 30 |

MB* = metal backing



- Type 11 shape (cup shape) is excellent for maximum surface area coverage for foundry and cleaning applications
- Available in popular sizes for right angle grinders on the market
- Metal-back option provides greater stability in tough grinding applications

A36Q - Resin Bonded

- Aluminum oxide grain
- For deburring and finishing
- Fast stock removal

METAL Ferrous metals (iron, steel, welds)

- Shank length 1-1/2"



Mandrel overhang "O" must always be the lowest possible. Maximum speeds given refer to overhang "O" equal to 1/2"



Die Grinder

A60R - Vitrified

- Aluminum oxide grain
- Ideal for ID grinding and mold finishing

METAL Ferrous metals

- Shank length 1-1/2"

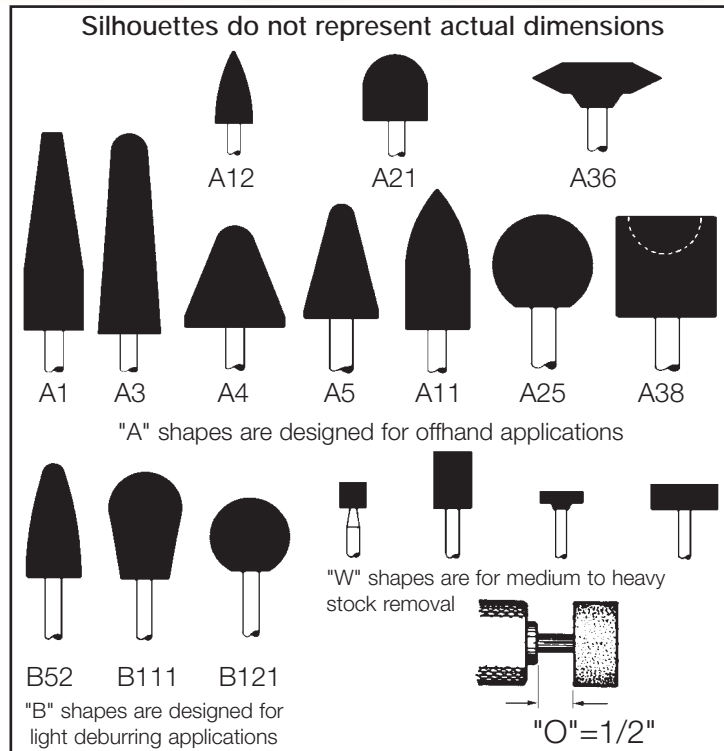

| Type | Size | | Shank Dia. | A36Q Part Number | A60R Part Number | "O" = 1/2" Max RPM | Qty Per Box |
|------|-------|--------|------------|------------------|------------------|--------------------|-------------|
| | Dia. | Length | | | | | |
| A1 | 3/4 | 2-1/2 | 1/4 | 27401 | 27010 | 19,800 | 10 |
| A3 | 1 | 2-3/4 | 1/4 | 27402 | 27020 | 16,100 | 10 |
| A4 | 1-1/4 | 1-1/4 | 1/4 | 27403 | 27030 | 30,560 | 10 |
| A5 | 3/4 | 1-1/8 | 1/4 | 27404 | 27035 | 45,000 | 10 |
| A11 | 7/8 | 2 | 1/4 | 27405 | 27040 | 19,860 | 10 |
| A12 | 11/16 | 1-1/4 | 1/4 | - | 27050 | 48,000 | 10 |
| A21 | 1 | 1 | 1/4 | - | 27060 | 34,500 | 10 |
| A25 | 1 | Round | 1/4 | - | 27070 | 35,620 | 10 |
| A36 | 1-5/8 | 3/8 | 1/4 | - | 27086 | 23,520 | 10 |
| A38 | 1 | 1 | 1/4 | 27406 | 27088 | 34,500 | 10 |
| B52 | 3/8 | 3/4 | 1/4 | 27407 | - | 45,370 | 20 |
| B52 | 3/8 | 3/4 | 1/8 | - | 27110 | 45,370 | 20 |
| B111 | 7/16 | 11/16 | 1/8 | - | 27120 | 33,750 | 20 |
| B121 | 1/2 | 1/2 | 1/8 | - | 27130 | 45,370 | 20 |
| W160 | 1/4 | 1/4 | 1/8 | - | 27308 | 81,370 | 10 |
| W177 | 3/8 | 3/4 | 1/8 | - | 27310 | 33,750 | 20 |
| W179 | 3/8 | 1-1/4 | 1/4 | 27408 | - | 45,750 | 10 |
| W189 | 1/2 | 2 | 1/4 | 27409 | 27327 | 24,000 | 10 |
| W196 | 5/8 | 1 | 1/4 | - | 27329 | 35,250 | 10 |
| W204 | 3/4 | 3/4 | 1/4 | 27410 | 27320 | 42,750 | 10 |
| W208 | 3/4 | 2 | 1/4 | 27411 | 27330 | 18,750 | 10 |
| W215 | 1 | 1/8 | 1/8 | - | 27338 | 38,200 | 10 |
| W220 | 1 | 1 | 1/4 | 27412 | 27360 | 25,500 | 10 |
| W222 | 1 | 2 | 1/4 | 27413 | 27340 | 15,900 | 10 |
| W225 | 1-1/4 | 1/4 | 1/4 | - | 27350 | 30,560 | 10 |
| W236 | 1-1/2 | 1/2 | 1/4 | 27414 | 27349 | 25,470 | 10 |



- These mounted bonded points are a low cost alternative to carbide burs
- Each point is dressed for perfect balance to perform without vibration or run-out

PIPELINE INTRODUCTION



- This section contains four 1/8" thick specifications
- Designed and manufactured to perform both cutting and light grinding.



A24R Pipeline
Long Life



Z24R
High Performance



A24 Turbo™
High Performance



Saitech™ Pipeline
High Performance
Stainless Steel



A24R Pipeline - Long Life

- Aluminum oxide grain
- For the pipeline industry
- Designed and manufactured to perform both cutting and light grinding
- Long life

METAL Ferrous metals
(steel, cast iron, etc.)



A24 Turbo™ - High Performance

- Aluminum oxide grain
- For the pipeline industry
- High performance cutting, notching and light grinding
- Long life

METAL Ferrous metals
(steel, cast iron, etc.)

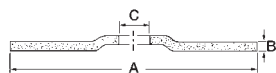

| Size | | | Max RPM | Part Number | | Qty Per Box | Qty Per Ctn | Lbs Per Box |
|--------|---------|--------|---------|-------------|--------|-------------|-------------|-------------|
| A Dia. | B Width | C Bore | | Pipeline | Turbo | | | |
| 3 | 1/8 | 3/8 | 18,000 | 22005 | - | 25 | 100 | 2 |
| 4 | 1/8 | 3/8 | 13,500 | 22007 | - | 25 | 100 | 4 |
| 4 | 1/8 | 5/8 | 13,500 | 22015 | - | 25 | 100 | 4 |
| 4-1/2 | 1/8 | 7/8 | 13,300 | 22030 | 23703 | 25 | 100 | 6 |
| 4-1/2 | 1/8 | 5/8-11 | 13,300 | 22130 | 23713* | 10 | 40 | 5 |
| 5 | 1/8 | 7/8 | 12,200 | 22040 | 23705 | 25 | 100 | 7 |
| 5 | 1/8 | 5/8-11 | 12,200 | 22140 | 23715* | 10 | 40 | 5 |
| 6 | 1/8 | 7/8 | 10,200 | 22042 | 23706 | 25 | 50 | 10 |
| 6 | 1/8 | 5/8-11 | 10,200 | 22046 | 23716 | 10 | 40 | 8 |
| 7 | 1/8 | 7/8 | 8,500 | 22055 | 23707 | 25 | 50 | 15 |
| 7 | 1/8 | 5/8-11 | 8,500 | 22052 | 23717 | 10 | 40 | 10 |
| 9 | 1/8 | 7/8 | 6,600 | 22065 | - | 25 | 50 | 25 |
| 9 | 1/8 | 5/8-11 | 6,600 | 22062 | - | 10 | 40 | 13 |



5/8-11 Super-Lock™ Hub



Angle Grinder

Note: Reusable 5/8-11 adaptor for use on Type 1 and Type 27 reinforced wheels with a 7/8 arbor, a max. diameter of 5" and a wheel thickness of .045 to 1/8" available on page 143 (part #95055).

* Part numbers 23713 and 23715 do not use Super-Lock™ Hub.



- Only wheel designed for both cutting and light grinding, eliminating the need for 2 separate wheels
- General purpose formulation provides optimum performance over a wide range of applications
- All sizes reinforced with the highest quality fiberglass for maximum safety and performance

TYPE 27

Specialty Pipeline Wheels

Cutting/Grinding

1/8"



TM

Z24R

- Tough zirconium grain
- High performance cutting and light grinding for the toughest applications

METAL Ferrous metals (iron, steel, welds)

STAINLESS Stainless steel, high tensile alloys



Saitech™ Pipeline

- High performance, ceramic aluminum oxide grain
- Very uniform, high density grain structure is extremely durable and self sharpening for long life and cooler cut
- Designed and manufactured to perform both high performance cutting and light grinding
- Long life combined with versatility for the pipeline industry

STAINLESS Stainless steel, high tensile alloys

METAL Ferrous metals (iron, steel, welds, etc.)

- High performance cutting and light grinding on stainless steel

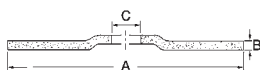

| Size | | | Max RPM | Part Number | | Qty Per Box | Qty Per Ctn | Lbs Per Box | |
|--------|---------|--------|---------|-------------|----------|-------------|-------------|-------------|----------|
| A Dia. | B Width | C Bore | | Z-tech™ | Pipeline | | | Z-tech™ | Pipeline |
| 4 | 1/8 | 5/8 | 13,500 | 22619 | - | 25 | 100 | 4 | - |
| 4-1/2 | 1/8 | 7/8 | 13,300 | 22620 | 22264 | 25 | 100 | 6 | 7 |
| 4-1/2 | 1/8 | 5/8-11 | 13,300 | 22630 | 22269 | 10 | 40 | 5 | 5 |
| 5 | 1/8 | 7/8 | 12,200 | 22622 | 22274 | 25 | 100 | 8 | 8 |
| 5 | 1/8 | 5/8-11 | 12,200 | 22632 | 22279 | 10 | 40 | 11 | 10 |
| 6 | 1/8 | 7/8 | 10,200 | 22623 | - | 25 | 100 | 11 | - |
| 6 | 1/8 | 7/8 | 10,200 | 22633 | - | 10 | 40 | 8 | - |
| 7 | 1/8 | 7/8 | 8,500 | 22624 | 22284 | 25 | 50 | 17 | 20 |
| 7 | 1/8 | 5/8-11 | 8,500 | 22634 | 22289 | 10 | 40 | 9 | 10 |
| 9 | 1/8 | 7/8 | 6,600 | 22626 | 22294 | 25 | 50 | 26 | 32 |
| 9 | 1/8 | 5/8-11 | 6,600 | 22636 | 22299 | 10 | 40 | 14 | 16 |



5/8-11 Super-Lock™ Hub



Angle Grinder

Note: Reusable 5/8-11 adaptor for use on Type 1 and Type 27 reinforced wheels with a 7/8 arbor, a max. diameter of 5" and a wheel thickness of .045 to 1/8" available on page 143 (part #95055)



- Only wheel designed for both cutting and light grinding, eliminating the need for 2 separate wheels
- All sizes reinforced with the highest quality fiberglass for maximum safety and performance
- Super-Lock™ Hub on all 5/8-11 threaded wheels is the safest, vibration-free design
- Patented 3M™ Cubitron™ grain formulation outlasts standard aluminum oxide wheels (Saitech™)

3M and Cubitron are trademarks of 3M

PIPELINE
STAINLESS STEEL/HIGH PERFORMANCE

CUTTING INTRODUCTION

- This section contains cut-off wheels (Type 27 and Type 1).
- These wheels will cut a wide range of materials.
- Some of the categories contain Specialty Wheels that are used for a specific application.
- For example, our Stud King® Chop Saw Wheel is specifically designed to cut metal studding and thin gauge metals.

| TYPE | TOOL | SPECIFICATIONS | PAGE |
|------|------|----------------|------|
|------|------|----------------|------|

Thin High Speed Cut-Off Wheels

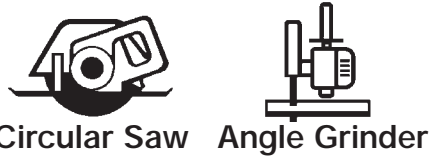

A24R
General Purpose
A36T
Long Life
A60S
Extremely fast cutting
A60T
Burr-free Cutting
Saitech™
Stainless Steel

38-39

.045, .090 & 1/16 High Speed Cut-Off Wheels



A60S
General Purpose
A46N
Aluminum
SAIT.M.X.™
Fast burr-free cutting
XA46R
Contaminant-Free
Saitech™
Stainless Steel

28-34

Chop Saw Wheels



EZ-Chop Attacker®
EZ-Chop®
General Purpose
Stud King®
Metal Studding
Iron Worker™
Angle Iron
Saitech™
Steel Worker®
Aluminum

41-43

3/32 & 1/8

















A24R
General Purpose
Saitech Ultimate Performance™
High Purpose/Stainless Steel
C24R
Concrete
XA24Q
Contaminant-Free

35-37

CUTTING INTRODUCTION

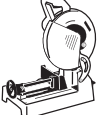

CUTTING

| TYPE | TOOL | SPECIFICATIONS | PAGE |
|---|--|---|---------------------|
| <p>Stationary Saw Cut-Off Wheels</p>  |  <p>Stationary Saw</p> | <p>A24N Fast Cutting</p> <p>A24R General Purpose</p> <p>A36R Stainless Steel</p> <p>C24R Concrete</p> | <p>48-49</p> |
| <p>Portable Saw Cut-Off Wheels</p>  |  <p>Portable Saw</p>  <p>Circular Saw</p>  <p>Angle Grinder</p> |  <p>Extremely Fast Cutting</p> <p>A24R General Purpose</p> <p>SAIT-Pro Metal</p> <p>Brute™ Metal Decking</p> <p>A30S Long Life</p> <p>Hobo® Rail Steel</p> <p>Ductile™ Ductile Pipe</p> <p>C24R Concrete</p> <p>Big M.A.C.™ Masonry, Asphalt, Concrete</p> | <p>40 44-46</p> |
| <p>Street Saw Wheels</p>  |  <p>Street Saw</p> | <p>C16 Fast Cutting</p> <p>C24R General Purpose</p> <p>Street Walker™ Asphalt</p> <p>Street Runner™ Asphalt, Green Concrete</p> | <p>47</p> |
| <p>Metal-Cutting Carbide Blades</p>  |  <p>Circular Saw</p>  <p>Worm Drive Saw</p>  <p>Metal-Cutting Circular Saw</p>  <p>Low RPM Metal-Cutting Saw</p> |  <p>Thin Metal Xtra</p>  <p>STAINLESS ALUMINUM</p> | <p>50-53</p> |

Cutting

.045"

TYPE 27 Depressed Center Wheels

Patented !

.045™

CUTTING

GENERAL PURPOSE



See pages 30-31 for Type 1 .045 cutting wheels for metal.

A60S - General Purpose

- So unique it has a patent
- Thin .045 width
- Special aluminum oxide grain
- Hard bond for extremely long life
- Fast, burr-free cutting

METAL Ferrous and/or non-ferrous metals (iron, steel, welds, etc.)

.045™

SAIT.M.X.™ - Thin Metal Xtra

- Special bond for cutting sheet metal and other thin gauge metals
- Fast, burr-free cutting

METAL Ferrous metals (carbon steel, etc.)

STAINLESS Stainless steel

A46N - Aluminum (Non-Ferrous Metals)

.045™

- Aluminum oxide grain
- Thin .045 width
- Soft bond for aggressive cutting without loading

ALUMINUM Non-ferrous metals (aluminum, copper, brass, etc.)

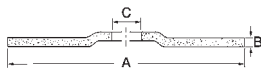

| Size | | | Max RPM | Grades Available | | | Qty Per Box | Qty Per Ctn | Lbs Per Box |
|--------|---------|--------|---------|------------------|-------|-------|-------------|-------------|-------------|
| A Dia. | B Width | C Bore | | Part Numbers | | | | | |
| 4 | .045 | 5/8 | 19,000 | 22011 | 22340 | - | 50 | 200 | 4 |
| 4-1/2 | .045 | 7/8 | 13,300 | 22021 | 22345 | 23654 | 50 | 200 | 4 |
| 5 | .045 | 7/8 | 12,200 | 22071 | 22350 | 23655 | 50 | 200 | 6 |
| 6 | .045 | 7/8 | 10,200 | 22047 | 22360 | 23656 | 50 | 200 | 8 |
| 7 | .045 | 7/8 | 8,500 | 22053 | 22370 | - | 50 | 200 | 14 |



Angle Grinder



- Unique, thin Type 27 shape can be used on all angle grinders in accordance with ANSI B7.1
- Special Aluminum Oxide formulation offers the fastest cutting, longest lasting thin wheels
- Externally reinforced with fiberglass layers to provide ultimate safety in a thin wheel

TYPE 27 High Performance Wheels

Saitech Cutting .045"

Patented!

TM



Z-Tech - High Performance

- So unique it has a patent
- Thin .045 width
- Special zirconium grain
- Hard bond for extremely long life
- Fast, burr-free cutting

METAL

Ferrous and/or non-ferrous metals (iron, steel, welds, etc.)

STAINLESS

Stainless steel, high tensile alloys



TM

- High performance, ceramic aluminum oxide grain
- Very uniform, high density grain structure is extremely durable and self sharpening for long life and cooler cut
- So unique it has a patent
- Thin .045 width
- Fast cutting with long life

STAINLESS

Stainless steel, high tensile alloys

METAL

Ferrous metals (iron, steel, welds, etc.)



See pages 30-31 for Type 1 .045 wheels

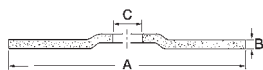

| Size | | | Max RPM | Grades Available | | Qty Per Box | Qty Per Ctn | Lbs Per Box |
|--------|---------|--------|---------|------------------|----------|-------------|-------------|-------------|
| A Dia. | B Width | C Bore | | Z-Tech™ | Saitech™ | | | |
| 4 | .045 | 5/8 | 19,000 | 23333 | 22068 | 50 | 200 | 4 |
| 4-1/2 | .045 | 7/8 | 13,300 | 23334 | 22072 | 50 | 200 | 4 |
| 5 | .045 | 7/8 | 12,200 | 23335 | 22073 | 50 | 200 | 6 |
| 6 | .045 | 7/8 | 10,200 | 23336 | 22082 | 50 | 200 | 8 |
| 7 | .045 | 7/8 | 8,500 | 23337 | 22088 | 50 | 200 | 14 |



Angle Grinder



Note: Reusable 5/8-11 adaptor for use on Type 1 and Type 27 reinforced wheels with a 7/8 arbor, a max. diameter of 5" and a wheel thickness of .045 to 1/8" available on page 143 (part #95055)



- Manufactured with patented 3M™ Cubitron™ grain to outlast standard aluminum oxide wheels
- Thin cutting wheel in a Type 27 shape makes this perfect for your angle grinder
- Unique bonding system lets you make faster burr-free cuts
- Designed to provide very long life for fewer wheel changes and less downtime
- All sizes reinforced with the highest quality fiberglass for maximum safety and performance

3M and Cubitron are trademarks of 3M

CUTTING

STAINLESS STEEL/HIGH PERFORMANCE

Cutting

.045"

TYPE 1

Thin High Speed Cut-Off

CUTTING

GENERAL PURPOSE



See pages 28-29 for Type 27 depressed center .045 cutting wheels for metal.



A60S - General Purpose **.045**™

- Thin .045 width
- Use with reusable 5/8-11 adaptor to fit angle grinders
- Extremely fast cutting with long life

METAL Ferrous and/or non-ferrous metals (iron, steel, welds, etc)

SAIT.M.X.™
(Ferrous Metals)

- Special bond for cutting sheet metal and other thin gauge metals
- Fast, burr-free cutting

METAL Ferrous metals (carbon steel, etc.)

STAINLESS Stainless steel

A46N - Aluminum
(Non-Ferrous Metals)

- Aluminum oxide grain
- Soft bond for aggressive cutting without loading
- Use with reusable 5/8-11 adaptor to fit angle grinders

ALUMINUM Non-ferrous metals (aluminum, copper, brass, etc.)

Note: Reusable 5/8-11 adaptor for use on Type 1 and Type 27 reinforced wheels with a 7/8 arbor, a max. diameter of 5" and a wheel thickness of .045 to 1/8" available on page 143 (part #95055)

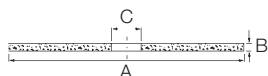

| Size | | | Max RPM | Grades Available | | | Qty Per Box | Qty Per Ctn | Lbs Per Box |
|--------|---------|--------|---------|------------------|------------|-------|-------------|-------------|-------------|
| A Dia. | B Width | C Bore | | Part Numbers | | | | | |
| | | | | A60S | SAIT.M.X.™ | A46N | | | |
| 4 | .045 | 5/8 | 19,000 | 23099 | - | 23304 | 50 | 200 | 4 |
| 4-1/2 | .045 | 7/8 | 13,300 | 23101 | 23604 | 23314 | 50 | 200 | 4 |
| 5 | .045 | 7/8 | 12,200 | 23103 | 23605 | 23315 | 50 | 200 | 6 |
| 6 | .045 | 5/8 | 10,200 | 23105 | - | 23310 | 50 | 200 | 8 |
| 6 | .045 | 7/8 | 10,200 | 23106 | 23606 | 23316 | 50 | 200 | 8 |
| 7 | .045 | 5/8 | 8,500 | 23107 | - | 23317 | 50 | 200 | 14 |



Angle Grinder



Circular Saw



- Type 1 shape for square, burr-free cutting
- Special aluminum oxide formulation offers the fastest cutting, longest lasting thin wheels
- Externally reinforced with fiberglass layers to provide ultimate safety in a thin wheel
- Wide range of sizes available to fit both angle grinders and circular saws

TYPE 1 Thin High Speed Cut-Off

Cutting .045"



Z-tech - High Performance

- Special zirconium grain formula
- Fast, non-binding cutting

METAL Ferrous metals

STAINLESS Stainless steel, high tensile alloys

- High performance, ceramic aluminum oxide grain
- Very uniform, high density grain structure is extremely durable and self sharpening for long life and cooler cut
- Thin .045 width
- Use with reusable 5/8-11 adaptor to fit angle grinders
- Combines fast cutting with extremely long life

STAINLESS Stainless steel, high tensile alloys

METAL Ferrous and/or non-ferrous metals

XA46R - Contaminant-Free

- Specially formulated for nuclear and food processing plants
- Free of iron, chlorine and sulphur compounds (Fe + Cl + S < 0.1%)
- All wheels are 1/16" thick

STAINLESS Stainless steel and other high tensile alloys

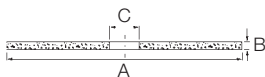

| Size | | | Max RPM | Grades Available | | | Qty Per Box | Qty Per Ctn | Lbs Per Box |
|--------|---------|--------|---------|------------------|----------|-------|-------------|-------------|-------------|
| A Dia. | B Width | C Bore | | Z-Tech™ | Saitech™ | XA46R | | | |
| 4 | .045 | 5/8 | 19,000 | 23323 | 23172 | - | 50 | 200 | 4 |
| 4-1/2 | .045 | 7/8 | 13,300 | 23324 | 23174 | - | 50 | 200 | 4 |
| 4-1/2 | 1/16 | 7/8 | 13,300 | - | - | 24251 | 50 | 200 | 7 |
| 5 | .045 | 7/8 | 12,200 | 23325 | 23177 | - | 50 | 200 | 6 |
| 5 | 1/16 | 7/8 | 12,200 | - | - | 24252 | 50 | 200 | 7 |
| 6 | .045 | 5/8 | 10,200 | 23326 | 23181 | - | 50 | 200 | 8 |
| 6 | .045 | 7/8 | 10,200 | 23327 | 23182 | - | 50 | 200 | 8 |
| 6 | 1/16 | 7/8 | 10,200 | - | - | 24253 | 50 | 200 | 14 |
| 7 | .045 | 5/8 | 8,500 | 23328 | 23184 | - | 50 | 200 | 14 |
| 7 | 1/16 | 7/8 | 8,500 | - | - | 24254 | 50 | 200 | 14 |

NEW

Note: Reusable 5/8-11 adaptor for use on Type 1 and Type 27 reinforced wheels with a 7/8 arbor, a max. diameter of 5" and a wheel thickness of .045 to 1/8" available on page 143 (part #95055)

See pages 28-29 for Type 27 depressed center .045 cutting wheels for metal.



Angle Grinder



Circular Saw



- Type 1 shape for square, burr-free cutting
- Patented 3M™ Cubitron™ grain formulation outlasts standard aluminum oxide wheels
- Externally reinforced with fiberglass layers to provide ultimate safety in a thin wheel
- Wide range of sizes available to fit both angle grinders and circular saws
- Specially formulated for contaminant-free stock removal on stainless steel (XA46R)

3M and Cubitron are trademarks of 3M

CUTTING

STAINLESS STEEL/HIGH PERFORMANCE

Cutting

.090"

TYPE 27 Depressed Center Wheels

CUTTING

SPECIALTY



A60S - General Purpose

- Thin .090 width
- Special aluminum oxide grain
- Hard bond for extremely long life
- Excellent for notching and cutting

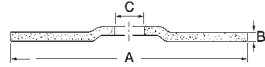

METAL Ferrous and/or non-ferrous metals (iron, steel, welds, etc.)

| Size | | | Max RPM | Part Number | Qty Per Box | Qty Per Ctn | Lbs Per Box |
|--------|---------|--------|---------|-------------|-------------|-------------|-------------|
| A Dia. | B Width | C Bore | | | | | |
| 4 | .090 | 5/8 | 19,000 | 20902 | 25 | 100 | 4 |
| 4-1/2 | .090 | 7/8 | 13,300 | 20903 | 25 | 100 | 4 |
| 4-1/2 | .090 | 5/8-11 | 13,300 | 20913 | 10 | 40 | 5 |
| 5 | .090 | 7/8 | 12,200 | 20904 | 25 | 100 | 6 |
| 5 | .090 | 5/8-11 | 12,200 | 20914 | 10 | 40 | 5 |
| 6 | .090 | 7/8 | 10,200 | 20905 | 25 | 100 | 8 |
| 6 | .090 | 5/8-11 | 10,200 | 20915 | 10 | 40 | 7 |
| 7 | .090 | 7/8 | 8,500 | 20906 | 25 | 100 | 14 |
| 7 | .090 | 5/8-11 | 8,500 | 20916 | 10 | 40 | 11 |
| 9 | .090 | 7/8 | 6,600 | 20909 | 25 | 50 | 21 |
| 9 | .090 | 5/8-11 | 6,600 | 20919 | 10 | 40 | 11 |

TM

Patented !



Z-tech High Performance

- Tough zirconium grain
- High performance cutting and notching for the toughest applications

METAL Ferrous metals (iron, steel, welds)

STAINLESS Stainless steel, high tensile alloys

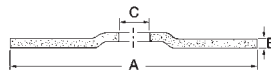

| Size | | | Max RPM | Part Number | Qty Per Box | Qty Per Ctn | Lbs Per Box |
|--------|---------|--------|---------|-------------|-------------|-------------|-------------|
| A Dia. | B Width | C Bore | | | | | |
| 4 | .090 | 5/8 | 19,000 | 20942 | 25 | 100 | 4 |
| 4-1/2 | .090 | 7/8 | 13,300 | 20943 | 25 | 100 | 4 |
| 4-1/2 | .090 | 5/8-11 | 13,300 | 20953 | 10 | 40 | 5 |
| 5 | .090 | 7/8 | 12,200 | 20944 | 25 | 100 | 6 |
| 5 | .090 | 5/8-11 | 12,200 | 20954 | 10 | 40 | 5 |
| 6 | .090 | 7/8 | 10,200 | 20945 | 25 | 100 | 8 |
| 6 | .090 | 5/8-11 | 10,200 | 20955 | 10 | 40 | 7 |
| 7 | .090 | 7/8 | 8,500 | 20946 | 25 | 100 | 14 |
| 7 | .090 | 5/8-11 | 8,500 | 20956 | 10 | 40 | 11 |

Note: Reusable 5/8-11 adaptor for use on Type 1 and Type 27 reinforced wheels with a 7/8 arbor, a max. diameter of 5" and a wheel thickness of .045 to 1/8" available on page 143 (part #95055)



- Unique, thin Type 27 shape can be used on all angle grinders in accordance with ANSI B7.1
- Special bond formulation offers the fastest cutting, longest lasting thin wheels
- Externally reinforced with fiberglass layers to provide ultimate safety in a thin wheel

TYPE 27

Saitech Cutting

Saitech High Performance Wheels .090"

Patented!

Saitech Ultimate Performance™

- High performance, ceramic aluminum oxide grain
- Very uniform, high density grain structure is extremely durable and self sharpening for long life and cooler cut
- Combines fast cutting with extremely long life for tough cutting applications
- Ideal for foundry applications (gates, risers)

STAINLESS Stainless steel, high tensile alloys

METAL Ferrous metals (iron, steel, welds, etc.)



CUTTING

STAINLESS STEEL

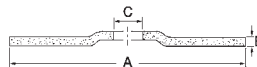

| Size | | | Max RPM | Part Number | Qty Per Box | Qty Per Ctn | Lbs Per Box |
|--------|---------|--------|---------|-------------|-------------|-------------|-------------|
| A Dia. | B Width | C Bore | | | | | |
| 4 | .090 | 5/8 | 19,000 | 20922 | 25 | 100 | 4 |
| 4-1/2 | .090 | 7/8 | 13,300 | 20923 | 25 | 100 | 4 |
| 4-1/2 | .090 | 5/8-11 | 13,300 | 20933 | 10 | 40 | 5 |
| 5 | .090 | 7/8 | 12,200 | 20924 | 25 | 100 | 6 |
| 5 | .090 | 5/8-11 | 12,200 | 20934 | 10 | 40 | 5 |
| 6 | .090 | 7/8 | 10,200 | 20925 | 25 | 100 | 8 |
| 6 | .090 | 5/8-11 | 10,200 | 20935 | 10 | 40 | 7 |
| 7 | .090 | 7/8 | 8,500 | 20926 | 25 | 100 | 14 |
| 7 | .090 | 5/8-11 | 8,500 | 20936 | 10 | 40 | 11 |



- Manufactured with patented 3M™ Cubitron™ grain to outlast standard aluminum oxide wheels
- Unique bonding system lets you make faster burr-free cuts
- Designed to provide very long life for fewer wheel changes and less downtime
- All sizes externally reinforced with the highest quality fiberglass for maximum safety and performance

3M and Cubitron are trademarks of 3M

Cutting

.090"

TYPE 1 High Speed Cut-Off Wheels

CUTTING

SPECIALTY



A60S - General Purpose

- Aluminum oxide grain
- Provides consistent performance with long life

METAL Ferrous metals (steel, angle iron, rebar)



Z-tech High Performance

- Tough zirconium grain
- High performance cutting and notching for the toughest applications

METAL Ferrous metals (iron, steel, welds)

STAINLESS Stainless steel, high tensile alloys

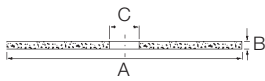

| Size | | | Max RPM | Grades Available | | Qty Per Box | Qty Per Ctn | Lbs Per Box |
|--------|---------|--------|---------|------------------|-------|-------------|-------------|-------------|
| A Dia. | B Width | C Bore | | Part Numbers | | | | |
| 4 | .090 | 5/8 | 19,000 | 23803 | 23823 | 25 | 100 | 4 |
| 4-1/2 | .090 | 7/8 | 13,300 | 23804 | 23824 | 25 | 100 | 4 |
| 5 | .090 | 7/8 | 12,200 | 23805 | 23825 | 25 | 100 | 6 |
| 6 | .090 | 7/8 | 10,200 | 23806 | 23826 | 25 | 100 | 8 |
| 7 | .090 | 5/8 | 8,500 | 23807 | 23827 | 25 | 50 | 14 |



Circular Saw



Angle Grinder



- Type 1 shape for square, burr-free cutting
- Externally reinforced with the highest quality fiberglass to withstand the toughest applications
- Available in many arbor sizes to fit a wide variety of tools

TYPE 27 Specialty Cutting Wheels

Cutting 3/32"

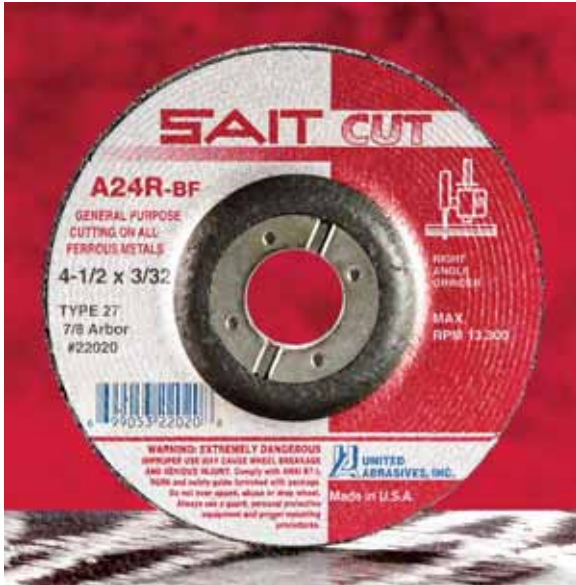

A24R - General Purpose

- Aluminum oxide grain
- For general purpose use
- Combines fast cutting and long life

METAL Ferrous metals (iron, steel, welds, etc.)

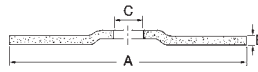

| Size | | | Max RPM | Part Number | Qty Per Box | Qty Per Ctn | Lbs Per Box |
|--------|---------|--------|---------|-------------|-------------|-------------|-------------|
| A Dia. | B Width | C Bore | | | | | |
| 3 | 1/8 | 3/8 | 18,000 | 22000 | 25 | 100 | 2 |
| 4 | 1/8 | 3/8 | 13,500 | 22010 | 25 | 100 | 3 |
| 4-1/2 | 3/32 | 7/8 | 13,300 | 22020 | 25 | 100 | 5 |
| 4-1/2 | 3/32 | 5/8-11 | 13,300 | 22120 | 10 | 40 | 7 |
| 5 | 3/32 | 7/8 | 12,200 | 22070 | 25 | 100 | 6 |
| 5 | 3/32 | 5/8-11 | 12,200 | 22170 | 10 | 40 | 7 |
| 6 | 1/8 | 7/8 | 10,200 | 22045 | 25 | 100 | 25 |
| 7 | 3/32 | 7/8 | 8,500 | 22056 | 25 | 100 | 14 |
| 7 | 3/32 | 5/8-11 | 8,500 | 22057 | 10 | 40 | 9 |
| 9 | 3/32 | 7/8 | 6,600 | 22066 | 25 | 50 | 22 |
| 9 | 3/32 | 5/8-11 | 6,600 | 22067 | 10 | 40 | 12 |



Angle Grinder



Z24R - Zirconium

- Tough zirconium grain
- High performance cutting for the toughest applications

METAL Ferrous metals (iron, steel, welds)

STAINLESS Stainless steel, high tensile alloys

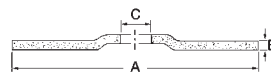

| Size | | | Max RPM | Part Number | Qty Per Box | Qty Per Ctn | Lbs Per Box |
|--------|---------|--------|---------|-------------|-------------|-------------|-------------|
| A Dia. | B Width | C Bore | | | | | |
| 4 | 3/32 | 5/8 | 13,500 | 22640 | 25 | 100 | 3 |
| 4-1/2 | 3/32 | 7/8 | 13,300 | 22641 | 25 | 100 | 7 |
| 4-1/2 | 3/32 | 5/8-11 | 13,300 | 22651 | 10 | 100 | 5 |
| 5 | 3/32 | 7/8 | 12,200 | 22643 | 25 | 100 | 6 |
| 5 | 3/32 | 5/8-11 | 12,200 | 22653 | 10 | 40 | 5 |
| 6 | 3/32 | 7/8 | 10,200 | 22644 | 25 | 25 | 10 |
| 6 | 3/32 | 5/8-11 | 10,200 | 22654 | 10 | 40 | 7 |
| 7 | 3/32 | 7/8 | 8,500 | 22645 | 25 | 100 | 14 |
| 7 | 3/32 | 5/8-11 | 8,500 | 22655 | 10 | 40 | 9 |
| 9 | 3/32 | 7/8 | 6,600 | 22646 | 25 | 50 | 22 |
| 9 | 3/32 | 5/8-11 | 6,600 | 22656 | 10 | 40 | 12 |



- For use on angle grinders
- Aggressive cutting performance over a wide range of applications
- Super-Lock™ Hub on all 5/8-11 threaded arbors is the safest, vibration-free design
- All sizes reinforced with the highest quality fiberglass for maximum safety and performance

CUTTING

SPECIALTY



Saitech Ultimate Performance™

- High performance, ceramic aluminum oxide grain
- Very uniform, high density grain structure is extremely durable and self sharpening for long life and cooler cut
- Combines fast cutting with extremely long life for tough cutting applications
- Ideal for foundry applications (gates, risers)

STAINLESS Stainless steel, high tensile alloys

METAL Ferrous metals (iron, steel, welds, etc.)

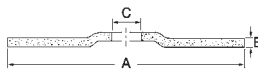

| Size | | | Max RPM | Part Number | Qty Per Box | Qty Per Ctn | Lbs Per Box |
|--------|---------|--------|---------|-------------|-------------|-------------|-------------|
| A Dia. | B Width | C Bore | | | | | |
| 4-1/2 | 3/32 | 7/8 | 13,300 | 22064 | 25 | 100 | 7 |
| 4-1/2 | 3/32 | 5/8-11 | 13,300 | 22069 | 10 | 40 | 5 |
| 5 | 3/32 | 7/8 | 12,200 | 22074 | 25 | 100 | 7 |
| 5 | 3/32 | 5/8-11 | 12,200 | 22079 | 10 | 40 | 5 |
| 7 | 3/32 | 7/8 | 8,500 | 22084 | 25 | 100 | 18 |
| 7 | 3/32 | 5/8-11 | 8,500 | 22089 | 10 | 40 | 10 |
| 9 | 3/32 | 7/8 | 6,600 | 22094 | 25 | 50 | 21 |
| 9 | 3/32 | 5/8-11 | 6,600 | 22099 | 10 | 40 | 11 |



- Manufactured with patented 3M™ Cubitron™ grain to outlast standard aluminum oxide wheels
- Unique bonding system lets you make faster burr-free cuts
- Designed to provide very long life for fewer wheel changes and less downtime
- Super-Lock™ Hub on all 5/8-11 threaded wheels is the safest, vibration-free design

TYPE 27 Depressed Center Wheels

Cutting
1/8"



C24R - Concrete

- Silicon carbide grain
- General purpose cutting, hard bond for long life

CONCRETE Masonry, concrete, stone

METAL Cast iron and other ferrous metals

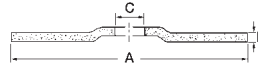

| Size | | | Max RPM | Part Number | Qty Per Box | Qty Per Ctn | Lbs Per Box |
|--------|---------|--------|---------|-------------|-------------|-------------|-------------|
| A Dia. | B Width | C Bore | | | | | |
| 4 | 1/8 | 5/8 | 13,500 | 22017 | 25 | 100 | 3 |
| 4-1/2 | 3/32 | 7/8 | 13,300 | 22025 | 25 | 100 | 5 |
| 4-1/2 | 3/32 | 5/8-11 | 13,300 | 22125 | 10 | 40 | 7 |
| 5 | 1/8 | 7/8 | 12,200 | 22041 | 25 | 100 | 7 |
| 5 | 1/8 | 5/8-11 | 12,200 | 22141 | 10 | 40 | 5 |
| 7 | 1/8 | 7/8 | 8,500 | 22050 | 25 | 100 | 14 |
| 7 | 1/8 | 5/8-11 | 8,500 | 22051 | 10 | 40 | 9 |
| 9 | 1/8 | 7/8 | 6,600 | 22060 | 25 | 50 | 22 |
| 9 | 1/8 | 5/8-11 | 6,600 | 22061 | 10 | 40 | 12 |



XA24Q - Contaminant-Free

- Specially formulated for nuclear and food processing plants
- Free of iron, chlorine and sulphur compounds (Fe + Cl + S <0.1%)

STAINLESS Stainless steel and other high tensile alloys

METAL Ferrous metals (iron, steel, welds, etc.)

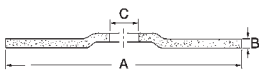

| Size | | | Max RPM | Part Number | Qty Per Box | Qty Per Ctn | Lbs Per Box |
|--------|---------|--------|---------|-------------|-------------|-------------|-------------|
| A Dia. | B Width | C Bore | | | | | |
| 4-1/2 | 1/8 | 7/8 | 13,300 | 24310 | 25 | 100 | 5 |
| 5 | 1/8 | 7/8 | 12,200 | 24315 | 25 | 100 | 5 |
| 6 | 1/8 | 7/8 | 10,200 | 24320 | 25 | 100 | 8 |
| 7 | 1/8 | 7/8 | 8,500 | 24325 | 25 | 50 | 13 |
| 9 | 1/8 | 7/8 | 6,600 | 24330 | 25 | 50 | 20 |



5/8-11 Super-Lock™ Hub



Angle Grinder



- Special silicon carbide grain formula is excellent for cutting masonry, concrete, stone and aggregate (C24R)
- All sizes reinforced with the highest quality fiberglass for maximum safety and performance
- Super-Lock™ Hub on all 5/8-11 threaded wheels is the safest, vibration-free design
- Specially formulated for contaminant-free stock removal on stainless steel (XA24Q)

CUTTING

STAINLESS STEEL/CONCRETE

Cutting



Circular Saw



Angle Grinder

TYPE 1

Thin High Speed Cut-off

CUTTING

GENERAL PURPOSE



* These sizes are typically used for tool room applications

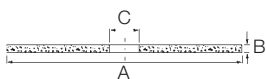

| Size | | | Max RPM | Grades Available Part Numbers | | | Qty Per Box | Qty Per Ctn | Lbs Per Box |
|--------|---------|--------|---------|-------------------------------|-------|-------|-------------|-------------|-------------|
| A Dia. | B Width | C Bore | | A36T | A60S | A60T | | | |
| 4-1/2 | .045 | 7/8 | 13,300 | - | 23101 | - | 50 | 200 | 4 |
| 5 | .045 | 7/8 | 12,200 | - | 23103 | - | 50 | 200 | 2 |
| 6 | 1/16 | 1/2 | 10,186 | 23202 | - | 23203 | 50 | 50 | 8 |
| 6 | 1/16 | 5/8 | 10,186 | 23200 | - | 23201 | 50 | 50 | 8 |
| 6 | .035 | 1/2 | 10,186 | 23206 | - | 23207 | 50 | 50 | 5 |
| 6 | .035 | 7/8 | 10,186 | 23210 | - | 23211 | 50 | 50 | 5 |
| 6 | .035 | 5/8 | 10,186 | 23204 | - | 23205 | 50 | 50 | 5 |
| 6 | .045 | 5/8 | 10,200 | - | 23105 | - | 50 | 200 | 4 |
| 6 | .045 | 7/8 | 10,200 | - | 23106 | - | 50 | 200 | 4 |
| 7* | 1/16 | 1-1/4 | 8,732 | 23250 | - | 23251 | 50 | 50 | 12 |
| 7 | 1/16 | 5/8 | 8,732 | 23265 | - | 23266 | 50 | 50 | 6 |
| 7* | .035 | 1-1/4 | 8,732 | 23252 | - | 23253 | 50 | 50 | 4 |
| 7 | .045 | 5/8 | 8,500 | - | 23107 | - | 50 | 200 | 4 |
| 8 | 1/16 | 5/8 | 7,640 | 23275 | - | 23276 | 50 | 50 | 7 |
| 8* | 1/16 | 1-1/4 | 7,640 | 23277 | - | 23278 | 50 | 50 | 7 |

A24R - General Purpose

- Aluminum oxide grain
- General purpose, long life

METAL Ferrous metals (iron, steel, welds, etc.)

A36T - Fast Cutting

- Aluminum oxide grain
- Hard bond for aggressive cutting on rough applications

METAL Ferrous metals (iron, steel, welds, etc.)

STAINLESS Stainless steel

A60S

- Thin .045 width
- Use with reusable 5/8-11 adaptor to fit angle grinders
- Extremely fast cutting with long life

METAL Ferrous and/or non-ferrous metals (iron, steel, welds, etc.)

A60T - Burr Free

- Hard bond for smooth cutting
- For use in nuclear, aerospace, automotive, foundry industries, and plant maintenance

METAL Ferrous metals (iron, steel, welds, etc.)

STAINLESS High tensile metals



Quick Tip

Try .045 sizes for longer life and better value



- Type 1 shape for square, burr-free cutting
- Externally reinforced with fiberglass layers to provide ultimate safety in a thin wheel
- Wide range of grit sizes available for aggressive action to burr-free cutting

TYPE 1

Thin High Speed Cut-off Wheels

Cutting



Die Grinder

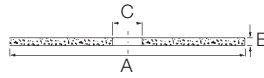

For items A24R, A36T, A60S, and A60T see descriptions on page 38

| A Dia. | Size | | Max RPM | Grades Available Part Numbers | | | | Qty Per Box | Qty Per Ctn | Lbs Per Box |
|--------|---------|--------|---------|-------------------------------|-------|-------|-------|-------------|-------------|-------------|
| | B Width | C Bore | | A24R | A36T | A60S | A60T | | | |
| 2 | 1/16 | 1/4 | 30,558 | - | 23004 | - | 23005 | 50 | 50 | 1 |
| 2 | 1/16 | 3/8 | 30,558 | - | 23002 | - | 23003 | 50 | 50 | 1 |
| 2 | .035 | 1/4 | 30,558 | - | 23012 | - | 23013 | 100 | 100 | 1 |
| 2 | .035 | 3/8 | 30,558 | - | 23010 | - | 23011 | 100 | 100 | 1 |
| 2-1/2 | 1/16 | 1/4 | 24,446 | - | 23022 | - | 23023 | 50 | 50 | 2 |
| 2-1/2 | 1/16 | 3/8 | 24,446 | - | 23020 | - | 23021 | 50 | 50 | 2 |
| 2-1/2 | .035 | 1/4 | 24,446 | - | 23032 | - | 23033 | 100 | 100 | 2 |
| 2-1/2 | .035 | 3/8 | 24,446 | - | 23030 | - | 23031 | 100 | 100 | 2 |
| 3 | 1/16 | 1/4 | 25,000 | - | 23042 | - | 23043 | 50 | 50 | 3 |
| 3 | 1/16 | 3/8 | 25,000 | - | 23040 | - | 23041 | 50 | 50 | 3 |
| 3 | .035 | 1/4 | 25,000 | - | 23052 | - | 23053 | 100 | 100 | 3 |
| 3 | .035 | 3/8 | 25,000 | - | 23050 | - | 23051 | 100 | 100 | 3 |
| 3 | 1/8 | 3/8 | 20,372 | 23060 | - | - | - | 25 | 100 | 2 |
| 4 | 1/16 | 1/4 | 19,000 | - | 23067 | - | 23068 | 50 | 50 | 5 |
| 4 | 1/16 | 3/8 | 19,000 | - | 23065 | - | 23066 | 50 | 50 | 5 |
| 4 | 1/16 | 5/8 | 19,000 | - | 23061 | - | 23062 | 50 | 50 | 5 |
| 4 | .035 | 1/4 | 19,000 | - | 23071 | - | 23072 | 100 | 100 | 5 |
| 4 | .035 | 3/8 | 19,000 | - | 23069 | - | 23070 | 100 | 100 | 5 |
| 4 | .035 | 5/8 | 19,000 | - | 23063 | - | 23064 | 100 | 100 | 5 |
| 4 | .045 | 5/8 | 19,000 | - | - | 23099 | - | 50 | 200 | 4 |
| 4 | 1/8 | 3/8 | 15,278 | 23075 | - | - | - | 25 | 100 | 4 |



1/4" shank adaptors for wheels up to 3" diameter available on page 143

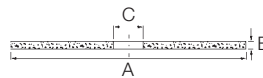

| A Dia. | Size | | Max RPM | Part Number | Qty Per Box | Qty Per Ctn | Lbs Per Box |
|--------|---------|--------|---------|-------------|-------------|-------------|-------------|
| | B Width | C Bore | | | | | |
| 3 | 1/16 | 1/4 | 25,000 | 23142 | 50 | 50 | 2 |
| 3 | 1/16 | 3/8 | 25,000 | 23140 | 50 | 50 | 2 |
| 3 | .035 | 1/4 | 25,000 | 23152 | 100 | 100 | 3 |
| 3 | .035 | 3/8 | 25,000 | 23150 | 100 | 100 | 3 |
| 4 | 1/16 | 1/4 | 19,000 | 23167 | 50 | 50 | 4 |
| 4 | 1/16 | 3/8 | 19,000 | 23165 | 50 | 50 | 4 |
| 4 | 1/16 | 5/8 | 19,000 | 23161 | 50 | 50 | 4 |
| 4 | .035 | 1/4 | 19,000 | 23171 | 100 | 100 | 5 |
| 4 | .035 | 3/8 | 19,000 | 23169 | 100 | 100 | 5 |
| 4 | .035 | 5/8 | 19,000 | 23163 | 100 | 100 | 5 |

Saitech Ultimate Performance™

- High performance, ceramic aluminum oxide grain
- Very uniform, high density grain structure is extremely durable and self sharpening for long life and cooler cut
- High Performance
- Combines fast cutting with extremely long life

STAINLESS Stainless steel, high tensile alloys

METAL Ferrous and/or non-ferrous metals



- Type 1 shape for square, burr-free cutting
- Patented 3M™ Cubitron™ grain formulation outlasts standard aluminum oxide wheels (Saitech™)
- Externally reinforced with fiberglass layers to provide ultimate safety in a thin wheel

CUTTING STAINLESS STEEL/METAL



Circular Saw



Angle Grinder

A24R - General Purpose

- Aluminum oxide grain
- Provides consistent performance with long life

METAL Ferrous metals (steel, angle iron, rebar)

A30S - Long Life

- Special aluminum oxide grain formula
- Fast, non-binding cutting

METAL Ferrous metals

STAINLESS Stainless steel, high tensile alloys

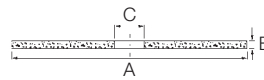

| Size | | | Max RPM | Grades Available | | Qty Per Box | Qty Per Ctn | Lbs Per Box |
|--------|---------|------------|---------|------------------|-------|-------------|-------------|-------------|
| A Dia. | B Width | C Bore | | Part Numbers | | | | |
| 4-1/2 | 5/64 | 7/8 | 13,300 | - | 23102 | 50 | 200 | 9 |
| 4-1/2 | 3/32 | 7/8 | 13,300 | 23100 | - | 50 | 200 | 10 |
| 5 | 5/64 | Dia. (5/8) | 12,200 | - | 23226 | 50 | 200 | 11 |
| 5 | 5/64 | 7/8 | 12,200 | - | 23224 | 50 | 200 | 11 |
| 6-1/2 | 3/32 | Dia. (5/8) | 8,500 | 23222 | - | 25 | 50 | 8 |
| 7 | 5/64 | Dia. (5/8) | 8,500 | - | 23242 | 25 | 50 | 10 |
| 7 | 5/64 | 7/8 | 8,500 | - | 23240 | 25 | 50 | 10 |
| 7 | 3/32 | 5/8 | 8,500 | 23230 | - | 25 | 50 | 10 |
| 7 | 3/32 | Dia. (5/8) | 8,500 | 23234 | - | 25 | 50 | 10 |
| 7 | 3/32 | 7/8 | 8,500 | 23232 | - | 25 | 50 | 10 |
| 8 | 3/32 | Dia. (5/8) | 7,600 | - | 23246 | 25 | 50 | 13 |
| 8 | 3/32 | 5/8 | 7,600 | 23254 | - | 25 | 50 | 13 |
| 8 | 3/32 | Dia. (5/8) | 7,600 | 23258 | - | 25 | 50 | 13 |
| 9 | 3/32 | 7/8 | 6,600 | - | 23248 | 25 | 50 | 19 |

C24R - Concrete

- Silicon carbide grain
- Long life

CONCRETE Stone, brick, soft aggregate, masonry, concrete

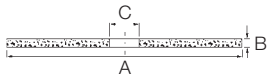

| Size | | | Max RPM | Part Number | Qty Per Box | Qty Per Ctn | Lbs Per Box |
|--------|---------|-----------|---------|-------------|-------------|-------------|-------------|
| A Dia. | B Width | C Bore | | | | | |
| 6-1/2 | 3/32 | Dia (5/8) | 8,500 | 23223 | 25 | 50 | 7 |
| 7 | 3/32 | 7/8 | 8,500 | 23233 | 25 | 50 | 9 |
| 7 | 3/32 | Dia (5/8) | 8,500 | 23235 | 25 | 50 | 9 |
| 7 | 3/32 | 5/8 | 8,500 | 23231 | 25 | 50 | 9 |
| 8 | 3/32 | 7/8 | 7,600 | 23257 | 25 | 50 | 11 |
| 8 | 3/32 | Dia (5/8) | 7,600 | 23259 | 25 | 50 | 11 |
| 8 | 3/32 | 5/8 | 7,600 | 23255 | 25 | 50 | 11 |



- Type 1 shape for square, burr-free cutting
- External fiberglass reinforcement withstands offhand lateral pressure for added safety and controlled performance

CHOP SAW WHEELS





SAIT EZ-Chop Attacker®

- Aluminum oxide grain
- General purpose economy cutting
- Fast cutting on thin metals

METAL

Metal studding, thin rebar, light gauge and medium metals



Quick Tip

Use this wheel as an economical alternative for general purpose cutting.



SAIT EZ-Chop®

- Aluminum oxide grain
- General purpose cool cutting on thin metals
- Burr-free finish

METAL

Metal studding, thin rebar, light gauge and heavy metals

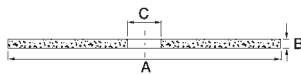

| Size | | | Max RPM | Part Numbers | | Qty Per Box | Qty Per Ctn | Lbs Per Box |
|--------|---------|--------|---------|-------------------|----------|-------------|-------------|-------------|
| A Dia. | B Width | C Bore | | EZ-Chop Attacker® | EZ-Chop® | | | |
| 12 | 3/32 | 1 | 5,100 | - | 24034 | 10 | 50 | 11 |
| 14 | 3/32 | 1 | 4,400 | 24500 | 24039 | 10 | 20 | 16 |



- EZ-Chop® Attacker is the best economy general purpose chop saw blade
- Specially formulated ultrathin design for fast cutting of thin gauge metals and heavy metals
- Externally reinforced with the highest quality fiberglass to withstand the toughest applications

TYPE 1 Chop Saw Wheels

Cutting



TM

Z-tech - High Performance

- Special zirconium grain formula
- Fast, non-binding cutting

METAL Ferrous metals

STAINLESS Stainless steel, high tensile alloys

Stud King®

- Aluminum oxide grain
- General purpose cool cutting on thin metals
- Burr-free finish

METAL Metal studding, thin rebar, light gauge metals

Iron Worker™

- Aluminum oxide grain
- Fast cutting
- Excellent for use on angle iron, channel iron, heavy rebar, and other ferrous metals

METAL Structural metal applications

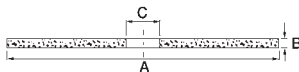

| Size | | | Max RPM | Grades Available | | | | | Qty Per Box | Qty Per Ctn | Lbs Per Box |
|--------|---------|--------|---------|------------------|-------|-------|----------|-------|-------------|-------------|-------------|
| A Dia. | B Width | C Bore | | Part Numbers | | | | | | | |
| | | | | Z-Tech | S.K. | I.W. | Saitech™ | Alum. | | | |
| 10 | 3/32 | 5/8 | 6,100 | - | 24035 | - | - | - | 25 | 50 | 20 |
| 12 | 3/32 | 1 | 5,100 | 24412 | 24030 | 24031 | 24033 | - | 10 | 50 | 11 |
| 14 | 3/32 | 1 | 4,400 | 24414 | 24050 | 24051 | 24053 | 24052 | 10 | 20 | 16 |
| 16 | 3/32 | 1 | 3,700 | 24416 | 24010 | 24011 | 24013 | - | 10 | 20 | 23 |

Saitech Steel Worker®

- Formulated with 3M™ Cubitron™ grain
- Extremely fast, burr-free cutting

STAINLESS Stainless steel, high tensile alloys

METAL Ferrous metals (steel, iron, welds, etc.)

Non-Ferrous Metals (Aluminum)

- Aluminum oxide grain
- Special non-loading formulation

METAL Non-ferrous metals (aluminum, bronze, brass, etc.)



Quick Tip

Use the Steel Worker® for fast cool cutting on stainless steel.



- Specially formulated for use on low horsepower chop saw machines for fast cutting with minimal pressure
- Five specialty formulas give you the exact wheel for your cutting application
- Z-tech is internally reinforced with the highest quality fiberglass to withstand the toughest applications

3M and Cubitron are trademarks of 3M

CUTTING

HIGH PERFORMANCE/SPECIALTY



TYPE 1 Portable Saw Cut-off Wheels



A24R - General Purpose/Durability

- Special aluminum oxide grain
- Provides consistent performance with long life

METAL Ferrous metals (steel, angle iron, rebar)

XFC™ - Extremely Fast Cutting

- Special aluminum oxide grain formula
- Fast cutting action
- Non-binding cutting formula

METAL Ferrous metals

STAINLESS Stainless steel, high tensile alloys



SAIT Pro - Metal

- Aluminum oxide grain
- Best value for a fast cut

METAL Ferrous metals

NEW!

All 14" and 16" portable wheels now formulated for high powered saws

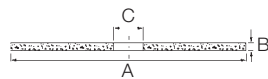

| Size | | | Max RPM | Grades Available | | | Qty Per Box | Qty Per Ctn | Lbs Per Box |
|--------|---------|--------|---------|------------------|----------|-------|-------------|-------------|-------------|
| A Dia. | B Width | C Bore | | Part Numbers | | | | | |
| | | | | A24R | SAIT Pro | XFC™ | | | |
| 12 | 1/8 | 1 | 6,300 | 23410 | - | - | 10 | 50 | 13 |
| 12 | 1/8 | 20mm | 6,300 | 23420 | - | - | 10 | 50 | 14 |
| 14 | 1/8 | 1 | 5,400 | 23450 | 24135 | 24150 | 10 | 20 | 19 |
| 14 | 1/8 | 20mm | 5,460 | 23455 | 24140 | 24160 | 10 | 20 | 24 |
| 16 | 1/8 | 1 | 4,800 | 23459 | - | - | 10 | 20 | 30 |
| 16 | 1/8 | 20mm | 4,800 | 23470 | - | - | 10 | 20 | 30 |

14" (20mm) with higher RPM rating for STIHL saws



- Type 1 shape for square, burr-free cutting
- Externally reinforced with the highest quality fiberglass to withstand the toughest applications
- Available in many arbor sizes to fit a wide variety of tools

TYPE 1

Portable Saw Cut-off Wheels

Cutting



Portable Saw

Brute™

- Long life
- Extremely hard bond for cutting metals that present a very sharp edge to the wheel

METAL Thin metal, sheet metal, decking, other ferrous metals

HOBO®

- For use on high horsepower machines
- Rugged fiberglass reinforcement for maximum safety
- Excellent for the railroad industry

METAL Mainline, secondary, spur rail steel

METAL Also for use on heavy sections of ferrous metals (I-beams, bar stock, etc.)



Ductile™

- Combination aluminum oxide and silicon carbide formulation

METAL Ductile pipe (very hard steel casing enclosing a cement lining), water mains, etc.

CONCRETE Combination metal/concrete, cast iron, hard metals, concrete coated steel, etc.

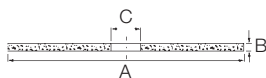

| Size | | | Max RPM | Part Number | Qty Per Box | Qty Per Ctn | Lbs Per Box |
|-----------------|---------|--------|---------|-------------|-------------|-------------|-------------|
| A Dia. | B Width | C Bore | | | | | |
| Brute™ | | | | | | | |
| 12 | 1/8 | 1 | 6,300 | 23412 | 10 | 50 | 15 |
| 12 | 1/8 | 20mm | 6,300 | 23422 | 10 | 50 | 14 |
| 14 | 1/8 | 1 | 5,400 | 23452 | 10 | 20 | 22 |
| 14 | 1/8 | 20mm | 5,460 | 23457 | 10 | 20 | 18 |
| HOBO® | | | | | | | |
| 14 | 1/8 | 1 | 5,400 | 23501 | 10 | 20 | 22 |
| 16 | 1/8 | 1 | 4,800 | 23502 | 10 | 20 | 30 |
| Ductile™ | | | | | | | |
| 12 | 1/8 | 1 | 6,300 | 23415 | 10 | 50 | 15 |
| 12 | 1/8 | 20mm | 6,300 | 23425 | 10 | 50 | 15 |
| 14 | 1/8 | 1 | 5,400 | 23453 | 10 | 20 | 22 |
| 14 | 1/8 | 20mm | 5,460 | 23458 | 10 | 20 | 22 |
| 16 | 1/8 | 1 | 4,800 | 23480 | 10 | 20 | 30 |
| 16 | 1/8 | 20mm | 4,800 | 23478 | 10 | 20 | 30 |



Quick Tip

Use this Ductile™ wheel for extra hard metals, hydraulic hose and PVC pipe.

All 14" and 16" portable wheels now formulated for high powered saws

14" (20mm) with higher RPM rating for STIHL saws



- Type 1 shape for square, burr-free cutting
- Externally reinforced with the highest quality fiberglass to withstand the toughest applications
- Available in many arbor sizes to fit a wide variety of tools

CUTTING

SPECIALTY



CUTTING
CONCRETE



XFC™ - Extremely Fast Cutting

- Silicon carbide grain
- Best value for the fastest cutting
- Non-binding cutting formula

CONCRETE Stone, brick, soft aggregate, masonry, concrete



Big M.A.C.™ - Very Long Life

- Special silicon carbide grain
- Superior cutting action
- 40% longer life than general purpose concrete wheels

CONCRETE Masonry, Asphalt, Concrete

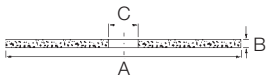

| Size | | | Max RPM | Part Number | Qty Per Box | Qty Per Ctn | Lbs Per Box |
|--------|---------|--------|---------|-------------|-------------|-------------|-------------|
| A Dia. | B Width | C Bore | | | | | |
| 12 | 1/8 | 1 | 6,300 | 23413 | 10 | 50 | 12 |
| 12 | 1/8 | 20mm | 6,300 | 23423 | 10 | 50 | 12 |
| 14 | 1/8 | 1 | 5,400 | 23451 | 10 | 20 | 16 |
| 14 | 1/8 | 20mm | 5,460 | 23456 | 10 | 20 | 15 |
| 16 | 1/8 | 1 | 4,800 | 23461 | 10 | 20 | 30 |
| 16 | 1/8 | 20mm | 4,800 | 23466 | 10 | 20 | 30 |

| | | | Big M.A.C.™ | | | | |
|----|-----|------|-------------|-------|----|----|----|
| 12 | 1/8 | 1 | 6,300 | 23460 | 10 | 50 | 14 |
| 12 | 1/8 | 20mm | 6,300 | 23462 | 10 | 50 | 14 |
| 14 | 1/8 | 1 | 5,400 | 23463 | 10 | 20 | 18 |
| 14 | 1/8 | 20mm | 5,460 | 23464 | 10 | 20 | 18 |

| | | | XFC™ | | | | |
|----|-----|------|-------|-------|----|----|----|
| 14 | 1/8 | 1 | 5,400 | 24155 | 10 | 20 | 16 |
| 14 | 1/8 | 20mm | 5,460 | 24165 | 10 | 20 | 15 |

C24R - Concrete

- Silicon carbide grain
- Long life

CONCRETE Stone, brick, soft aggregate, masonry, concrete, schedule 40 and schedule 80 PVC pipe

All 14" and 16" portable wheels now formulated for high powered saws

14" (20mm) with higher RPM rating for STIHL saws



- External fiberglass reinforcement withstands offhand lateral pressure for added safety and controlled performance
- Special silicon carbide grain formula provides excellent cutting action on masonry, concrete, stone and aggregate

TYPE 1 Street Saw Wheels

Cutting



Street Saw

NEW Premium Formula Outlasts Competition!

C16

- Silicon carbide grain
- Fast, free cutting

CONCRETE Green concrete, asphalt

Street Runner™

- Silicon carbide grain
- Hot pressed wheel
- Extremely dense wheel with coarse grain
- Combines fast cutting with extra-long life

CONCRETE Green concrete and asphalt

C24R

- Silicon carbide grain
- General purpose
- Long life

CONCRETE Masonry, concrete, brick

Street Walker™

- Silicon carbide grain
- Hot pressed wheel
- Combines fast cutting with long life

CONCRETE Concrete, green concrete, asphalt

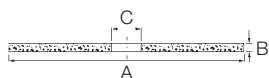

| Size | | | Max RPM | Grades Available | | | | Qty Per Box | Qty Per Ctn | Lbs Per Box |
|--------|---------|--------|---------|------------------|-------|-------|-------|-------------|-------------|-------------|
| A Dia. | B Width | C Bore | | Part Number | | | | | | |
| | | | | C16 | C24R | S.W. | S.R. | | | |
| 14 | 1/8 | 1 | 4,400 | 24045 | - | - | - | 10 | 20 | 19 |
| 14 | 3/16 | 1 | 4,400 | 24061 | 24060 | - | - | 5 | 10 | 12 |
| 14 | 1/4 | 1 | 4,400 | 24066 | 24065 | - | - | 5 | 10 | 16 |
| 14 | 3/16 | 1 | 4,365 | - | - | 24120 | 24130 | 10 | 50 | 27 |
| 14 | 1/4 | 1 | 4,365 | - | - | 24121 | 24131 | 10 | 50 | 36 |
| 18 | 1/4 | 1 | 3,000 | - | - | - | 24145 | 5 | 25 | 35 |

All wheels have Pinhole



- All wheels have pinholes for mounting on various machines, street saws, etc.
- These wheels can be used with cooling sprays for dust-free cutting needs
- The Street Walker™ blade is an excellent economical alternative to cutting with diamond blades

CUTTING

CONCRETE



A24N - Fast Cutting

- Aluminum oxide grain
- General purpose
- Soft bond for fast stock removal

METAL Ferrous metals (iron, cast iron, etc.)

STAINLESS Low grade stainless steel

A24R - Long Life

- Aluminum oxide grain
- General purpose, long life

METAL Ferrous metals (iron, steel, angle iron, etc.)

A36R - Burr-Free

- Aluminum oxide grain
- A finer grit for burr-free finish

METAL Ferrous metals (metal tubing, etc.)

STAINLESS Stainless steel, high tensile steel

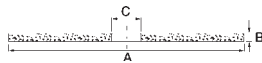

| Size | | | Max RPM | Grades Available | | | Qty Per Box | Qty Per Ctn | Lbs Per Box |
|--------|---------|--------|---------|------------------|-------|-------|-------------|-------------|-------------|
| A Dia. | B Width | C Bore | | Part Numbers | | | | | |
| 10 | 1/8 | 5/8 | 6,100 | 24001 | 24000 | 24002 | 25 | 50 | 23 |
| 10 | 1/8 | 1 | 6,100 | - | 24004 | - | 25 | 50 | 23 |
| 12 | 1/8 | 1 | 5,100 | - | 24020 | - | 10 | 50 | 14 |
| 14 | 1/8 | 1 | 4,400 | - | 24040 | 24042 | 10 | 20 | 19 |
| 16 | 5/32 | 1 | 3,800 | 24071 | 24070 | 24072 | 10 | 20 | 29 |
| 18 | 3/16 | 1 | 3,400 | 24081 | 24080 | 24082 | 5 | 20 | 22 |
| 20 | 3/16 | 1 | 3,000 | 24091 | 24090 | 24092 | 5 | 20 | 27 |
| 24 | 1/4 | 1 | 3,150 | 24101 | 24100 | 24102 | 5 | 15 | 49 |



- Type 1 shape for square, burr-free cutting
- Maximum grain exposure to cut through large diameter solid stock
- Internal fiberglass reinforcement for maximum safety and controlled performance
- Dual external mounting area reinforcement on 14" - 24" wheels

TYPE 1

Stationary Saw Cut-off Wheels

Cutting



Stationary Saw

C24R - Concrete

- Silicon carbide grain
- General purpose, long life
- Square cutting

CONCRETE Masonry, concrete, stone, brick



CUTTING

CONCRETE

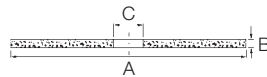

| Size | | | Max RPM | Part Number | Qty Per Box | Qty Per Ctn | Lbs Per Box |
|--------|---------|--------|---------|-------------|-------------|-------------|-------------|
| A Dia. | B Width | C Bore | | | | | |
| 10 | 1/8 | 5/8 | 6,100 | 24003 | 25 | 50 | 23 |
| 10 | 1/8 | 1 | 6,100 | 24007 | 25 | 50 | 23 |
| 12 | 1/8 | 1 | 5,100 | 24023 | 10 | 50 | 14 |
| 14* | 1/8 | 1 | 4,400 | 24043 | 10 | 20 | 19 |
| 16* | 5/32 | 1 | 3,800 | 24073 | 10 | 20 | 29 |
| 18 | 3/16 | 1 | 3,400 | 24083 | 5 | 20 | 22 |

* with Pinhole



- Special grain to fiberglass ratio provides added safety and excellent cutting performance on heavy-duty stationary saws
- Cutting wheels are balanced to provide straight, even cuts for alignment and aesthetics

NEW METAL-CUTTING CARBIDE BLADES



Low RPM Metal
Cutting Saw

Long Life

Cool Cutting

Fast, Burr-Free Cutting

KEY FEATURES

- Designed for use on professional metal-cutting saws
- Premium micro grain carbide: Smaller grains mean more carbide per tooth – stays sharp and provides longer life over competitive blades
- Cuts cool and fast
- Reduced fire hazards and less dust: Metal blades cut cleanly with minimal sparks

Metal-Cutting Carbide Blades



Cool cutting action
with long life

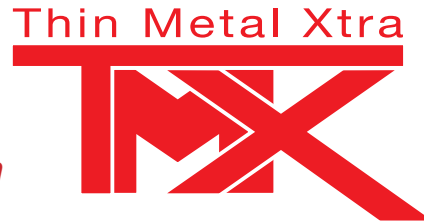

Fast, burr free cutting on:

- Angle Iron
- Rebar
- Steel Plate
- Channel Iron
- Pipe
- Threaded Rod
- C-Channel
- And other ferrous metals

Fast, burr free cutting on:

- Thin Metals
- Metal Studs
- Duct Work
- Sheet Metals
- Galvanized Roofing
- Thin Walled Pipe
- Conduit
- Strut Channel

| STEEL WORKER® | Diameter | Teeth | Grind | Arbor | RPM | Machine |
|---------------|----------------|-------|-------|------------------------|-------|---------|
| 77920 | 6-1/2 165mm | 40 | TCG | 5/8 16mm | 5,800 | |
| 77936 | 7 178mm | 36 | TCG | 20mm | 5,800 | |
| 77930 | 7-1/4 184mm | 40 | TCG | 5/8 16mm Diamond | 5,800 | |
| 77940 | 8 203mm | 40 | TCG | 5/8 16mm Diamond | 5,800 | |
| 77947 | 9 229mm | 48 | TCG | 1 26mm | 3,200 | |
| 77953 | 10 254mm | 52 | TCG | 5/8 16mm | 5,200 | * |
| 77962 | 12 305mm | 60 | TCG | 1 26mm | 2,000 | * |
| 77972 | 14 356mm | 72 | MTCG | 1 26mm | 1,800 | * |

*Low RPM Metal Cutting Saw

| TMX | Diameter | Teeth | Grind | Arbor | RPM | Machine |
|-------|----------------|-------|-------|------------------------|-------|---------|
| 77921 | 6-1/2 165mm | 48 | ATB | 5/8 16mm | 5,800 | |
| 77931 | 7-1/4 184mm | 68 | ATB | 5/8 16mm Diamond | 5,800 | |
| 77965 | 12 305mm | 80 | MTCG | 1 26mm | 2,000 | * |
| 77975 | 14 356mm | 90 | MTCG | 1 26mm | 1,800 | * |

*Low RPM Metal Cutting Saw

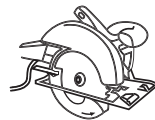

Circular Saw



Metal-Cutting
Circular Saw

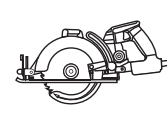

Worm Drive Saw



Low RPM
Metal-Cutting Saw

TYPICAL END USERS/INDUSTRIES

- STEEL WORKER®: Steel Fabricators, Electricians, Welding, Weld Shops, Plumbers, Power Generation, Metal Contractors, Manufacturing/Fabrication, Maintenance/Repair
- TMX - Thin Metal Extra: General Contractors, Plumbers, Roofing Contractors, Maintenance/Repair, Electricians, Power Generation Contractors, Heating and Air Conditioning

Metal-Cutting Carbide Blades

STAINLESS

Cool cutting action with long life and minimal distortion



Fast, burr free cutting on:

- Tubing, bars, pipe, and stainless steel plate

| STAINLESS | Diameter | Teeth | Grind | Arbor | RPM | Machine |
|-----------|----------------|----------|-------|------------------------|-------|---------|
| 77938 | 7 178mm | 48 | TCG | 20mm | 5,800 | |
| 77933 | 7-1/4 184mm | 48 | TCG | 5/8 16mm Diamond | 5,800 | |
| 77977 | 14 356mm | 90 80 | MTCG | 1 26mm | 1,800 | * |

*Low RPM Metal Cutting Saw

ALUMINUM

Cool cutting action with long life and minimal melting of aluminum



Fast, burr free cutting on:

- Aluminum, other non-ferrous metals and pipe

| ALUMINUM | Diameter | Teeth | Grind | Arbor | RPM | Machine |
|----------|----------------|-------|-------|------------------------|-------|---------|
| 77922 | 6-1/2 165mm | 60 | FTG | 5/8 16mm | 5,800 | |
| 77937 | 7 178mm | 54 | ATB | 20mm | 5,800 | |
| 77932 | 7-1/4 184mm | 60 | FTG | 5/8 16mm Diamond | 5,800 | |
| 77942 | 8 203mm | 60 | TCG | 5/8 16mm Diamond | 5,800 | |
| 77955 | 10 254mm | 80 | TCG | 5/8 16mm | 5,200 | * |
| 77966 | 12 305mm | 80 | TCG | 1 26mm | 2,000 | * |
| 77976 | 14 356mm | 80 | ATB | 1 26mm | 1,800 | * |

*Low RPM Metal Cutting Saw

TYPICAL END USERS/INDUSTRIES

- Stainless: Stainless Steel Contractors / Fabricators, Water Treatment Contractors, Kitchen Equipment Manufacturing, Power Generation Contractors
- Aluminum: Aluminum Contractors, Aluminum Foundries, Aluminum Grating & Fencing Contractors

Metal-Cutting Carbide Blades

Technical Data

CARBIDE GRAIN STRUCTURE

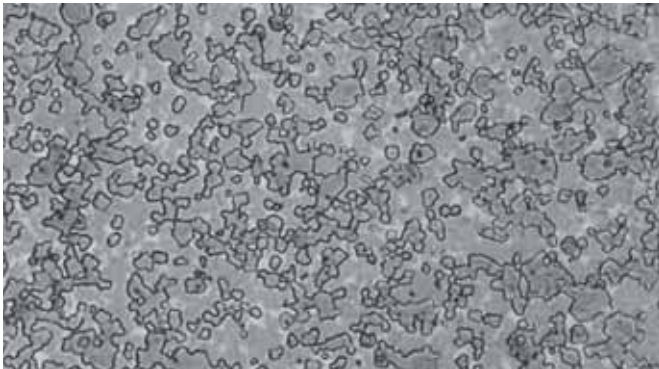

SAIT Carbide Matrix

Consistent size of carbide grains.
More carbide per tooth as grains are smaller.
Smaller grain = harder tooth, more durability.

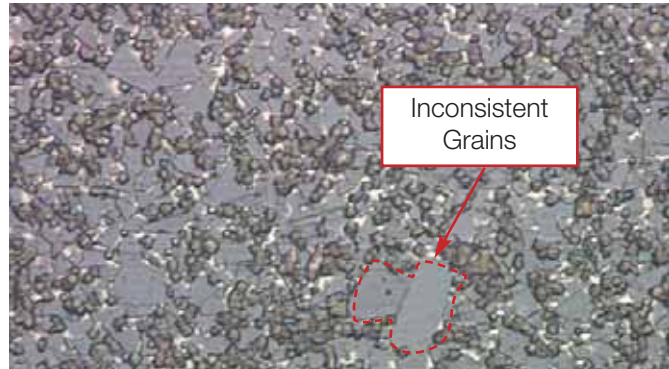

Competitor Carbide Matrix

Competitor Carbide Matrix
Very inconsistent size of carbide grains.
Less life due to larger grain sizes.

TOOTH CONFIGURATION

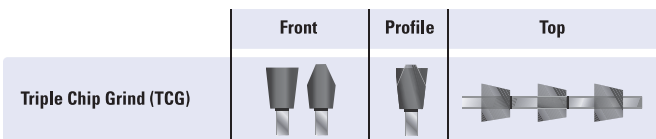

Triple Chip Grind (TCG):

- **FEATURE:** Maximizes blade life by reducing the size of the metal chips that are produced during the cutting operations. Also provides maximum tooth strength for longer life.
- **BENEFIT:** Cleaner and cooler cuts and less stress on material being cut.
- **WHERE USED:** Steelworker® (all sizes), 7-1/4" Stainless, 8", 10" and 12" Aluminum blades

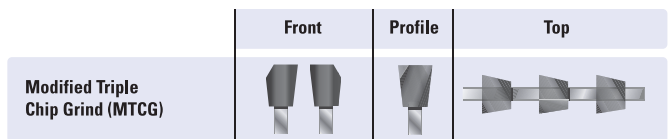

Modified Triple Chip Grind (MTCG):

- **FEATURE:** Excels at reducing chip size for more effective cutting of material. Also improves cutting tooth durability.
- **BENEFIT:** Lower heat build-up and less blade stress while cutting.
- **WHERE USED:** 12" and 14" TMX and 14" Stainless Steel Blades

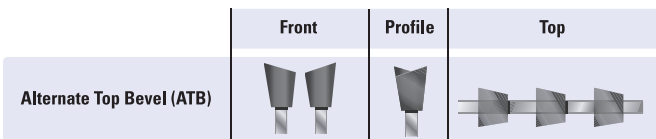

Alternate Top Bevel (ATB)

- **FEATURE:** A multi-purpose grind that allows for durable, long life as well as productive work across a wide range of materials.
- **BENEFIT:** Clean, easy cutting without binding in the material.
- **WHERE USED:** 6-1/2" and 7-1/4" TMX, and 14" Aluminum Blades

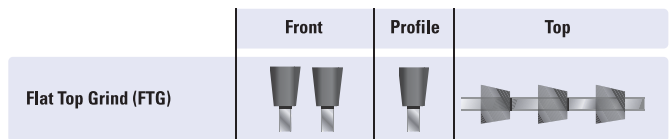

Flat Top Grind (FTG)

- **FEATURE:** Allows for smooth and easy cutting on non-ferrous materials (aluminum, brass, copper, etc.).
- **BENEFIT:** Fast cutting, especially when using hand-held saws.
- **WHERE USED:** 6-1/2" and 7-1/4" Aluminum blades

DIAMOND INTRODUCTION



Available in a variety of sizes and styles for common cutting applications.

DIAMOND

DIAMOND



Continuous Rim (CR)

- Continuous uniform rim for smooth, dry and wet cutting of tiles and ceramic materials.
- Longer lasting and faster cutting
- For use on small diameter electric saws

C Tile:

- Thin .060 for precise tile cutting

Tile & Ceramic

| Size | | | Max RPM | Part No. | Qty Per Box | Qty Per Ctn | Lbs Per Box |
|--------|---------|--------|---------|-----------|-------------|-------------|-------------|
| A Dia. | B Width | C Bore | | C Tile CR | | | |
| 4-1/2 | .060 | 7/8 | 13,300 | 48721 | 1 | 1 | 1 |
| 4-1/2 | .060 | 5/8 | 13,300 | 48521 | 1 | 1 | 1 |



Serrated Rim (Turbo)

- Continuous rim with alternating serrations for fast, cool cutting.
- Smooth cutting of almost any aggregate material
- For use on small diameter electric saws

CE/CC:

- CE is for general purpose cutting.
- CC is a longer lasting and faster cutting premium wheel.

CONCRETE Concrete, ceramic, granite, brick, blocks, marble

| Size | | | Max RPM | Part Number | | Qty Per Box | Qty Per Ctn | Lbs Per Box |
|--------|---------|--------|---------|---------------|-----------------|-------------|-------------|-------------|
| A Dia. | B Width | C Bore | | Turbo CE Prem | Turbo CC Prem + | | | |
| 4-1/2 | .090 | 7/8 | 13,300 | 48701 | 48711 | 1 | 1 | 1 |
| 4-1/2 | .090 | 5/8 | 13,300 | 48501 | 48511 | 1 | 1 | 1 |
| 5 | .090 | 7/8 | 12,200 | 48702 | 48712 | 1 | 1 | 1 |
| 5 | .090 | 5/8 | 12,200 | 48502 | 48512 | 1 | 1 | 1 |
| 7 | .090 | 7/8 | 8,500 | 48704 | 48714 | 1 | 1 | 1 |
| 7 | .090 | 5/8 | 8,500 | 48504 | 48514 | 1 | 1 | 1 |



Segmented Rim (Laser)

- Segmented rim allows for a cool cutting
- Laser welded, segmented wheels

LU/LV:

- LU is for general purpose dry cutting
- LV is a longer lasting and faster dry cutting premium wheel
- For use on small diameter electric saws

CONCRETE Concrete, ceramic, granite, brick, blocks, marble

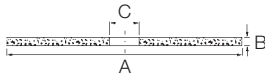

| Size | | | Max RPM | Part Number | | Qty Per Box | Qty Per Ctn | Lbs Per Box |
|--------|---------|--------|---------|---------------|-----------------|-------------|-------------|-------------|
| A Dia. | B Width | C Bore | | Laser LU Prem | Laser LV Prem + | | | |
| 4-1/2 | .090 | 7/8 | 13,300 | 48731 | 48741 | 1 | 1 | 1 |
| 4-1/2 | .090 | 5/8 | 13,300 | 48531 | 48541 | 1 | 1 | 1 |
| 5 | .090 | 7/8 | 12,200 | 48732 | 48742 | 1 | 1 | 1 |
| 5 | .090 | 5/8 | 12,200 | 48532 | 48542 | 1 | 1 | 1 |
| 7 | .090 | 7/8 | 8,500 | 48734 | 48744 | 1 | 1 | 1 |
| 7 | .090 | 5/8 | 8,500 | 48534 | 48544 | 1 | 1 | 1 |

Premium/Premium+ 12 & 14 inch

- Premium is a general purpose dry and wet fast cutting blade
- Premium Plus is a longer lasting dry and wet faster cutting premium wheel
- For use on high speed gasoline and electric hand held saws

CONCRETE Concrete, ceramic, granite, brick, blocks, marble

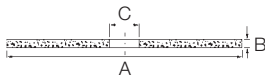

| Size | | | Max RPM | Part Number | | Qty Per Box | Qty Per Ctn | Lbs Per Box |
|--------|---------|--------|---------|-------------|--------|-------------|-------------|-------------|
| A Dia. | B Width | C Bore | | Prem | Prem + | | | |
| 12 | .110 | 1 | 5,100 | 48767 | 48757 | 1 | 1 | 6 |
| 12 | .110 | 20mm | 5,100 | 48567 | 48557 | 1 | 1 | 6 |
| 14 | .125 | 1 | 4,300 | 48768 | 48758 | 1 | 1 | 7 |
| 14 | .125 | 20mm | 4,300 | 48568 | 48558 | 1 | 1 | 6 |



- Premium quality diamond for exceptional cutting and long life
- Laser welded bonding to the metal core on segmented wheels for cutting wet or dry
- Specifications available in general purpose wheels and premium wheels

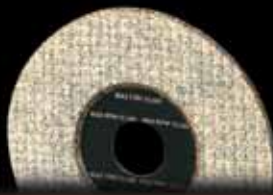

COTTON FIBER INTRODUCTION

Cotton Fiber Abrasives

Cotton reinforced abrasive products are laminates of non-woven abrasive cotton fiber impregnated with abrasive grain. The abrasive grains and fibers are impregnated by a special process that provides superior bonding and consistency.

Cotton reinforced products combine the free cutting qualities of resinoid and vitrified abrasives, and the finishing qualities of rubber bonded and non-woven abrasives. Their unique construction continually exposes new grain resulting in cooler operation, non-loading, and a smoother finish. They are resilient, smooth handling, and quiet, with reduced vibration.

Our new line of cotton reinforced products include Type 27 grinding and blending wheels, SAITBLEND™ discs, and SAIT-LOK-R™ cotton fiber discs, all for use on a wide range of applications. Varying bond hardnesses are suitable for both ferrous and non-ferrous materials, including stainless steel and aluminum. These cotton reinforced products are most commonly used in industries such as the welding trade, general fabrication, food and chemical processing, dairy, tool and die, automotive, aircraft, and aerospace.

RA (roughness average) Values on Cotton Fiber Products

Grinding/Blending Wheels

| Specification | 304 Stainless Steel | 6061 Aluminum |
|---------------|---------------------|---------------|
| A24UA-MTX | 140 RA | N/A |
| A36UA-GFX | 40 RA | 130 RA |
| A54UA-GFX | 30 RA | 80 RA |

SAITBLEND™ Discs

| Specification | 304 Stainless Steel | 6061 Aluminum |
|---------------|---------------------|---------------|
| A36F | 38 RA | 90 RA |
| A54F | 30 RA | 80 RA |
| A80F | 25 RA | 30 RA |

Sait-Lok-R™

| Specification | 304 Stainless Steel | 6061 Aluminum |
|---------------|---------------------|---------------|
| A24M | 70 RA | 90 RA |
| A36F | 40 RA | 60 RA |
| A54F | 30 RA | 50 RA |
| A80F | 20 RA | 45 RA |

COTTON
FIBER

COTTON FIBER

COTTON FIBER

Blending



Die Grinder



Angle Grinder

A24 UA-MTX

- Aluminum oxide grain
- UA-MTX tough resin combined with coarse grit
- Excellent for light or medium weld removal

METAL Grinding aluminum and other non-ferrous/ferrous materials

STAINLESS Stainless steel

A36 UA-GFX

- UA-GFX latex bond for weld blending
- Resilient for use on contours, non-loading

STAINLESS Stainless steel

METAL Aluminum, ferrous and/or non-ferrous material

A54 UA-GFX

- UA-GFX latex bond for weld blending and finishing

STAINLESS Stainless steel

METAL Aluminum, non-ferrous materials

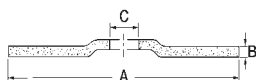

| Size | | | Max RPM | Grades Available | | | Qty Per Box | Lbs Per Box |
|--------|---------|--------|---------|------------------|-------|-------|-------------|-------------|
| A Dia. | B Width | C Bore | | A24 | A36 | A54 | | |
| 4 | 1/4 | 5/8 | 13,500 | 29200 | 29201 | 29202 | 10 | 3 |
| 4-1/2 | 1/4 | 7/8 | 13,300 | 29206 | 29207 | 29208 | 10 | 3 |
| 7 | 1/4 | 7/8 | 8,500 | 29212 | 29213 | 29214 | 10 | 9 |



Quick Tip

These wheels work great on aluminum without clogging or loading.

Cotton Fiber Mounted Points

- A54MTX - Resin Bond - light removal/blending
- A80GFX - Latex Bond - finer grit for ultimate finishing

STAINLESS Blending on stainless steel, high tensile alloys

METAL Aluminum, ferrous and/or non-ferrous materials



Mandrel overhang "O" must always be the lowest possible. Maximum speeds given refer to overhang "O" equal to 1/2"

NEW!

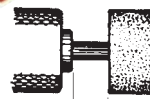

"O" = 1/2"



- Multiple layers of cotton impregnated with abrasive grain and special bonding agents allow for the coolest blending and finishing wheels
- Special cotton formula will never load on soft non-ferrous metals like aluminum
- Available in two bonding agents for use in many applications

COTTON FIBER

COTTON FIBER



A36F

- Aluminum oxide grain
- Open pattern on wheel allows for cool blending and finishing without loading
- A medium grit for finishes equal to an 80 grit coated disc
- Flexible for smooth blending and finishing

STAINLESS Stainless steel

METAL Aluminum and non-ferrous materials

A54F - A80F

- Aluminum oxide grain
- A finer grit for finishes equal to a 100 grit coated disc

STAINLESS Finishing stainless steel

METAL Finishing aluminum



SAITBLEND™ discs combine the long life and durability of a bonded Type 27 wheel with the flexibility and finishing capabilities of a coated disc. There is no need to change discs to go from blending to final finishing. A single disc will quickly blend your weld and finish equivalent to an 80 grit resin fiber disc, and the SAITBLEND™ disc will outlast the fiber disc 20:1.

See page 142 for backing pad part number 95011 for 7" disc

QT Quick Tip
Use the 7" 54 to 80 grit for an extra fine finish on stainless steel.

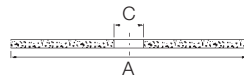

| Size | | Max RPM | Grades Available | | | Qty Per Box | Lbs Per Box |
|--------|--------|---------|------------------|-------|-------|-------------|-------------|
| A Dia. | C Bore | | Part Numbers | | | | |
| 4-1/2 | 7/8 | 13,300 | 29270 | 29271 | 29272 | 10 | 2 |
| 7 | 7/8 | 8,500 | 29277 | 29278 | 29279 | 10 | 5 |



- Waffle design pattern provides cool blending and finishing
- Unique cotton fiber laminate provides controlled blending and finishing
- Special non-loading formula can be used on any non-ferrous soft metal
- Outlasts fiber discs 20 to 1 for decreased downtime and material cost

COTTON FIBER

COTTON FIBER



Die Grinder



Portable Grinder

SAIT-LOK-R™ discs are made of multiple layers of cotton fiber abrasive impregnated material. These quick change discs produce a smooth finish in one step.

Finishing discs

A24M

- Aluminum oxide grain
- Coarse grit with medium flexibility for aggressive action

STAINLESS Blending on stainless steel, high tensile alloys

METAL Aluminum, ferrous and/or non-ferrous materials

Nylon screw threaded hub for easy mounting to the backing pad

See page 145 for backing pad



A36F

- Medium grit with higher flexibility for smoother action

STAINLESS Blending on stainless steel, high tensile alloys

METAL Aluminum, ferrous and/or non-ferrous materials

A54F

- Fine grit with higher flexibility for finishing

STAINLESS Blending on stainless steel, high tensile alloys

METAL Aluminum, ferrous and/or non-ferrous materials

A80F

- Finer grit for ultimate finishing

STAINLESS Blending on stainless steel, high tensile alloys

METAL Aluminum, ferrous and/or non-ferrous materials

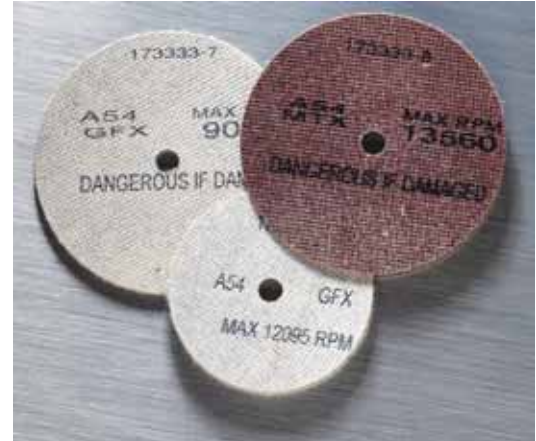

Deburring wheels

A54GFX/A54MTX

- Fine grit with higher flexibility for finishing

STAINLESS Deburring of stainless steel, high tensile alloys

METAL Aluminum, ferrous and/or non-ferrous materials

| Size Dia. | Max RPM | Part Numbers | | | | Qty Per Box | Lbs Per Box |
|--------------|------------|--------------|-------|-------|-------|-------------------|-------------------|
| | | A24M | A36F | A54F | A80F | | |
| 2 | 30,000 | 50300 | 50301 | 50302 | 50303 | 25 | 1 |
| 3 | 20,000 | 50308 | 50309 | 50310 | 50311 | 25 | 2 |

| Dia. | Size | | Max RPM | Grades Available Part Numbers | | Qty Per Box | Lbs Per Box |
|------|------------|------|------------|----------------------------------|--------|-------------------|-------------------|
| | A | C | | A54GFX | A54MTX | | |
| | B Width | Bore | | | | | |
| 3 | 1/16 | 3/8 | 18,000 | - | 29310 | 10 | 1 |
| 3 | 1/8 | 3/8 | 12,000 | 29312 | - | 10 | 1 |
| 4 | 1/16 | 3/8 | 13,500 | - | 29320 | 10 | 1 |
| 4 | 1/8 | 3/8 | 9,075 | 29322 | - | 10 | 1 |



- Multi-layer disc configuration provides longer life than coated abrasive discs
- Cotton fiber abrasive material will not smear on titanium and stainless steel
- Outlasts coated discs 10 to 1 for less downtime and increased productivity

HAND/FLOOR RUBS



Hand Rub

The vitrified bonding technique uses a high temperature process whereby abrasive materials are heated to a point where the grains fuse to each other, forming the bond posts. Vitrified products, although somewhat brittle, are not affected by water, oil, most acids, or temperature changes. Used primarily for precision and fixed-feed applications, they are particularly well suited for bench grinders and offhand tool room applications.



Hand and Floor Rubs

- Removes form marks

CONCRETE Concrete

- Configurations available:

Plain - For cleaning castings and dressing bench grinding wheels

Fluted - For extra shearing action

Handle - For extra comfort and working overhead

Scored - Breaks into two 4 x 2 x 2 floor rubs

Packaging

Each box of HR202 and FR521 contains 6 wood wedges

Additional wood wedges, see page 146

| Type | Size | | | Description | Grade | Part Number | Qty Per Box | Lbs Per Box |
|-------|--------|-------|--------|-------------|-------|-------------|-------------|-------------|
| | Length | Width | Height | | | | | |
| HR202 | 4 | 2 | 2 | Plain | C24R | 25010 | 6 | 7 |
| HR241 | 6 | 2 | 2 | Fluted | C24R | 25020 | 5 | 10 |
| HR242 | 8 | 2 | 2 | Fluted | C24R | 25030 | 5 | 12 |
| HR252 | 6 | 3 | 1 | Handle | C24R | 25040 | 5 | 10 |
| HR250 | 8 | 3-1/2 | 1-1/2 | Handle | C24R | 25050 | 5 | 19 |
| FR521 | 8 | 2 | 2 | Scored | C10R | 25060 | 3 | 14 |
| FR521 | 8 | 2 | 2 | Scored | C24R | 25061 | 3 | 14 |
| FR521 | 8 | 2 | 2 | Scored | C80R | 25062 | 3 | 14 |



- Vitrified bond for long life
- Available in several configurations for a wide range of cleaning and dressing applications

VITRIFIED

VITRIFIED

BENCH WHEELS



Bench Grinder

A

- Aluminum oxide grain
- General purpose
- For sharpening tools and light stock removal

METAL Ferrous metals
(carbon steel, steel, iron, forgings, etc.)

GC

- Green silicon carbide grain
- Extremely sharp grain for faster, burr-free cutting
- Use on carbide tipped tools, cast iron

METAL Ferrous and/or non-ferrous metals



Reduction bushings enclosed with each wheel

| Wheel Size | Bushings |
|------------|---------------|
| 6" | 3/4, 5/8, 1/2 |
| 7" | 3/4, 5/8, 1/2 |
| 8" | 3/4, 5/8 |
| 10" | 1, 3/4 |
| 12" | 1-1/4, 1 |
| 14" | 1-1/4, 1 |

Aluminum Oxide

| Size | | | Max RPM | Grades Available Part Numbers | | | | | Lbs Per Box |
|--------|---------|--------|---------|-------------------------------|-------|-------|-------|-------|-------------|
| A Dia. | B Width | C Bore | | A24 | A36 | A46 | A60 | A80 | |
| 6 | 1/2 | 1 | 4,138 | - | 28003 | - | 28004 | 28005 | 1-1/2 |
| 6 | 3/4 | 1 | 4,138 | - | 28000 | - | 28001 | 28002 | 2 |
| 6 | 1 | 1 | 4,138 | - | 28006 | - | 28007 | 28008 | 2-1/2 |
| 7 | 3/4 | 1 | 3,600 | - | 28010 | - | 28011 | 28012 | 2-1/2 |
| 7 | 1 | 1 | 3,600 | - | 28013 | - | 28014 | 28015 | 3-1/2 |
| 8 | 3/4 | 1 | 3,600 | - | 28020 | - | 28021 | 28022 | 3-1/2 |
| 8 | 1 | 1 | 3,600 | - | 28023 | - | 28024 | 28025 | 4-1/2 |
| 10 | 1 | 1-1/4 | 2,483 | - | 28040 | 28043 | 28041 | 28042 | 7 |
| 10 | 1-1/2 | 1-1/4 | 2,483 | - | 28050 | 28053 | 28051 | 28052 | 10 |
| 12 | 2 | 1-1/2 | 2,069 | 28060 | 28063 | 28061 | 28062 | - | 19-1/2 |
| 14 | 2 | 1-1/2 | 1,773 | 28070 | 28073 | 28071 | 28072 | - | 28 |

Green Silicon Carbide

| Size | | | Max RPM | Grades Available Part Numbers | | | Lbs Per Box |
|--------|---------|--------|---------|-------------------------------|-------|-------|-------------|
| A Dia. | B Width | C Bore | | GC60 | GC80 | GC120 | |
| 6 | 3/4 | 1 | 4,138 | 28100 | 28101 | 28102 | 1-1/2 |
| 6 | 1 | 1 | 4,138 | 28103 | 28104 | 28105 | 2 |
| 7 | 1 | 1 | 3,600 | 28113 | 28114 | 28115 | 2-1/2 |
| 8 | 1 | 1 | 3,600 | 28123 | 28124 | 28125 | 3-1/2 |
| 10 | 1 | 1-1/4 | 2,483 | 28140 | 28141 | 28142 | 6-1/2 |
| 10 | 1-1/2 | 1-1/4 | 2,483 | 28150 | 28151 | 28152 | 10 |
| 12 | 2 | 1-1/2 | 2,069 | 28160 | 28161 | 28162 | 19-1/2 |
| 14 | 2 | 1-1/2 | 1,773 | 28170 | 28171 | 28172 | 28 |



- Vitrified bond for long life
- Available in two formulations for a wide range of applications
- Individually packaged for safety and convenience

VITRIFIED

VITRIFIED

Coated and Non-Woven Abrasives



Fiber Discs



| | |
|--------------|-------|
| Introduction | Pg 71 |
| Fiber Discs | 72-76 |

Flap Discs



| | |
|---------------------|----------|
| Introduction | Pg 88-89 |
| Ovation® | 90-91 |
| Saitlam™/Saitlam K™ | 94 |
| Saitlam F™ | 93 |
| Saitlam™ UK, UP, PN | 92 |

Belts



| | |
|---------------------|----------|
| Introduction | Pg 64-65 |
| Belt Specifications | 66-69 |
| Custom Belts | 70 |

Laminated Discs



| | |
|-------------|----------|
| SAIT-LOK™ | Pg 77-79 |
| SAIT-LOK-R™ | |

Paper Discs



| | |
|---------------------|-------|
| Introduction | Pg 80 |
| PSA Disc Rolls | 81 |
| PSA Disc Individual | 82-83 |
| Hook & Loop | 84-85 |

Cloth Discs



| | |
|----------------|-------|
| Introduction | Pg 80 |
| Zirconium | 86 |
| Aluminum Oxide | 87 |

SAIT-PAK™



| | |
|-----------|--------|
| SAIT-PAK™ | Pg 140 |
|-----------|--------|

Flap Wheels



| | |
|----------------|-------|
| Small Diameter | Pg 95 |
| Large Diameter | 96 |

Sheets



| | |
|---------------------|---------|
| Introduction | Pg 97 |
| Cloth | 98 |
| Paper | 98-99 |
| Fileboard | 100-101 |
| Saitscreen™/Drywall | 102 |
| Sanding Sponges | 103 |

Shop Rolls



| | |
|---------------------|--------|
| Industrial/Handy | Pg 104 |
| Mini/Custom | 105 |
| Saitscreen™/Plumber | 106 |

Specialties



| | |
|-----------------|---------|
| Spiral Bands | Pg 107 |
| Cartridge Rolls | 108-109 |
| Cross Pads | 110 |
| Square Pads | 110 |

Floor Sanding



| | |
|--------------|---------|
| Sheets/Belts | Pg 111 |
| Discs | 112 |
| Rolls | 113 |
| Pads | 114-115 |

Accessory Items



| | |
|--------------|---------|
| Introduction | Pg 141 |
| Accessories | 142-148 |

Non-Woven



| | |
|----------------------------|---------|
| Introduction | Pg 116 |
| Hand Pads | 117 |
| Belts | 118 |
| Discs | 119-120 |
| SAIT-Strip™ Products | 121 |
| Flap Brushes | 122 |
| Interleaf Wheels | 123 |
| Unitized Wheels/Type 27 | 124-125 |
| Convolute Wheels | 126 |
| Sand-Light™ Blending Discs | 127 |
| Buffing Pads/Compounds | 128 |





BELTS INTRODUCTION

United Abrasives' belt program encompasses a variety of abrasive types, lengths and widths, and grits, to cover a multitude of belt sanding needs. Each belt is made of the highest quality industrial materials, with resin over resin construction, and a strong bi-directional tape splice. The selection of grain types and backing material is engineered to each application. Belts are available in the Quick Ship™ or Blue Line™ programs, and the United Abrasives' Custom Belt Program. The following is a description of each program and the available products:



Quick Ship™ Belts

The Quick Ship™ belt program makes available those belts that are most popular in terms of the industrial user. Each package of belts is shrink-wrapped in quantities of 10.

Materials Available

- Z-H (zirconium)
- 1A-X/2A-X (closed coat aluminum oxide)
- AO-X (open coat aluminum oxide)
- C-W (silicon carbide wet/dry belts)
- LA-X (closed coat, aluminum oxide)

Available Grits

- 24-80
- 24-320
- 24-180
- 60-220
- 40-120

See pages 66-69 for further information



Blue Line™ Belts

The Blue Line™ belt program encompasses the widest range of popular belts packaged for retail. Belts are supplied in either 5 or 10 belts per box, depending on grit. Blue Line™ boxes lend themselves to being displayed - either on pegboard hooks or shelving. They should be ordered when a display package is desired, or when a desired belt type is not available as part of the Quick Ship™ program.

Materials Available

- Z-H (zirconium)
- 1A-X/2A-X (closed coat, aluminum oxide)
- AO-X (open coat aluminum oxide)
- C-W (silicon carbide wet/dry belts)

Available Grits

- 24-80
- 24-320
- 24-180
- 60-220

See pages 67-68 for further information



SAIT-Saver™ Belts

The SAIT-Saver™ belt program is the economy alternative for portable belts. Available in aluminum oxide, closed coat material. Each package of belts is shrink-wrapped in quantities of 10.

See pages 66-69 for further information

Custom Belt Program

United Abrasives will custom make high quality industrial belts to your length and width specifications with our United Abrasives' Custom Belt Program. Available in a variety of materials to suit specific applications.

See page 70 for further information

COATED
ABRASIVES

BELTS

BELTS INTRODUCTION



The United Abrasives stock belt program provides the most popular industrial and commercial belt sizes in an easy to order program. The following materials are available through this program.

Zirconia Alumina Cloth

| | | |
|--|--|--|
| <p>Z-H 24-80 Grit Range Closed Coat</p> | <p>Zirconia alumina abrasive material on a H-weight, waterproof polyester backing for heavy duty grinding and finishing on ferrous and non-ferrous metals, cast iron, aluminum, and stainless steel.</p> | |
|--|--|--|

Aluminum Oxide Cloth

| | | |
|--|--|--|
| <p>1A-X/2A-X 24-400 Grit Range Closed Coat</p> | <p>Semi-friable(1A-X)/heat-treated(2A-X) aluminum oxide grain on a X-weight cotton backing. For general purpose grinding and finishing of ordinary and alloyed steels, ferrous and non-ferrous metals, cast iron and wood.</p> | |
| <p>AO-X 24-180 Grit Range Open Coat</p> | <p>Semi-friable aluminum oxide grain on a X-weight cotton backing. For general purpose, open coat grinding, polishing and finishing of materials that have the tendency to load. For use on non-ferrous metals, aluminum and wood.</p> | |
| <p>LA-X - SAIT-Saver™ 40-120 Grit Range Closed Coat</p> | <p>Semi-friable aluminum oxide grain on a X-weight cotton backing. For low cost grinding and finishing of ordinary and alloyed steels, ferrous and non-ferrous metals, cast iron and wood. Used exclusively in SAIT-Saver™.</p> | |

Silicon Carbide Cloth

| | | |
|---|--|--|
| <p>C-W 60-220 Grit Range Closed Coat</p> | <p>Silicon carbide grain on waterproof, X-weight cotton backing. For grinding and finishing hard cast iron, aluminum, glass, ceramics, non-ferrous metals, plastics, rubber, marble and stone.</p> | |
|---|--|--|

COATED
ABRASIVES

BELTS



Portable Sander



File Sander



Backstand Sander



Benchstand Sander

BELTS

Closed Coat
Aluminum
OxideClosed Coat
Zirconium
OxideClosed Coat
Aluminum
OxideSAIT-Saver™
Closed Coat
Aluminum OxideOpen Coat
Aluminum
OxideClosed Coat
ZirconiumClosed Coat
Silicon
Carbide

| Size | Grit | 1AX/2AX Quick Ship™ Part No. | ZH Quick Ship™ Part No. |
|--------------|----------|------------------------------------|-------------------------------|
| 1/4 x 18 | 36 | 60016 | 64016 |
| | 40 | 60017 | 64017 |
| | 50 | 60018 | 64018 |
| | 60 | 60019 | 64019 |
| | 80 | 60020 | 64020 |
| | 100 | 60021 | |
| 1/4 x 24 | 120 | 60022 | |
| | 36 | 60030 | 64030 |
| | 40 | 60031 | 64031 |
| | 50 | 60032 | 64032 |
| | 60 | 60033 | 64033 |
| | 80 | 60034 | 64034 |
| 3/8 x 13 | 100 | 60035 | |
| | 120 | 60036 | |
| | 36 | 61121 | |
| | 40 | 61122 | |
| | 50 | 61123 | |
| | 60 | 61124 | |
| 1/2 x 12 | 80 | 61125 | |
| | 100 | 61126 | |
| | 120 | 61127 | |
| | 36 | 60044 | |
| | 40 | 60045 | |
| | 50 | 60046 | |
| 1/2 x 18 | 60 | 60047 | |
| | 80 | 60048 | |
| | 100 | 60049 | |
| | 120 | 60050 | |
| | 36 | 60058 | 64058 |
| | 40 | 60059 | 64059 |
| 1/2 x 24 | 50 | 60060 | 64060 |
| | 60 | 60061 | 64061 |
| | 80 | 60062 | 64062 |
| | 100 | 60063 | |
| | 120 | 60064 | |
| | 3/4 x 18 | 36 | 60086 |
| 40 | | 60087 | 64087 |
| 50 | | 60088 | 64088 |
| 60 | | 60089 | 64089 |
| 80 | | 60090 | 64090 |
| 100 | | 60091 | |
| 3/4 x 20-1/2 | 120 | 60092 | |
| | 36 | 60114 | 64114 |
| | 40 | 60115 | 64115 |
| | 50 | 60116 | 64116 |
| | 60 | 60117 | 64117 |
| | 80 | 60118 | 64118 |
| 1 x 12 | 100 | 60119 | |
| | 120 | 60120 | |
| | 36 | 60128 | 64128 |
| | 40 | 60129 | 64129 |
| | 50 | 60130 | 64130 |
| | 60 | 60131 | 64131 |
| 1 x 21 | 80 | 60132 | 64132 |
| | 100 | 60133 | |
| | 120 | 60134 | |
| | 36 | 60141 | |
| | 40 | 60142 | |
| | 50 | 60143 | |
| 1 x 21 | 60 | 60144 | |
| | 80 | 60145 | |
| | 100 | 60146 | |
| | 120 | 60147 | |
| | 36 | 60254 | |
| | 40 | 60255 | |
| 1 x 21 | 50 | 60256 | |
| | 60 | 60257 | |
| | 80 | 60258 | |
| | 100 | 60259 | |
| | 120 | 60260 | |

| Size | Grit | 1AX/2AX Quick Ship™ Part No. | LA-X Quick Ship™ Part No. | AO-X Quick Ship™ Part No. | Z-H Quick Ship™ Part No. | C-W Quick Ship™ Part No. | |
|------------|--------|------------------------------------|---------------------------------|---------------------------------|--------------------------------|--------------------------------|--|
| 1 x 30 | 24 | | | 63200 | | | |
| | 36 | 61094 | | 63201 | | | |
| | 40 | 61095 | | 63202 | | | |
| | 50 | 61096 | | 63203 | | | |
| | 60 | 61097 | | 63204 | | | |
| | 80 | 61098 | | 63205 | | | |
| | 100 | 61099 | | 63206 | | | |
| | 120 | 61100 | | 63207 | | | |
| | 150 | | | 63208 | | | |
| | 180 | | | 63209 | | | |
| | 1 x 42 | 24 | | | 63210 | | |
| | | 36 | 60310 | | 63211 | 58152 | |
| 40 | | 60311 | 60623 | 63212 | 58153 | | |
| 50 | | 60312 | 60624 | 63213 | 58154 | | |
| 60 | | 60313 | 60625 | 63214 | 58155 | 58000 | |
| 80 | | 60314 | 60626 | 63215 | 58156 | 58001 | |
| 100 | | 60315 | 60627 | 63216 | | 58002 | |
| 120 | | 60316 | 60628 | 63217 | | 58003 | |
| 150 | | 60317 | | 63218 | | 58004 | |
| 180 | | 60318 | | 63219 | | 58005 | |
| 220 | | 60319 | | | | 58006 | |
| 240 | | 60320 | | | | | |
| 320 | 60322 | | | | | | |
| 1-1/2 x 60 | 36 | 61133 | | | | | |
| | 40 | 61134 | | | | | |
| | 50 | 61135 | | | | | |
| | 60 | 61136 | | | | | |
| | 80 | 61137 | | | | | |
| | 100 | 61138 | | | | | |
| | 120 | 61139 | | | | | |
| | 2 x 48 | 24 | | | 63220 | | |
| 36 | | 60506 | | 63221 | | | |
| 40 | | 60507 | | 63222 | | | |
| 50 | | 60508 | | 63223 | | | |
| 60 | | 60509 | | 63224 | | | |
| 80 | | 60510 | | 63225 | | | |
| 100 | | 60511 | | 63226 | | | |
| 120 | | 60512 | | 63227 | | | |
| 150 | | | 63228 | | | | |
| 180 | | | 63229 | | | | |
| 2 x 60 | 36 | 60520 | | | 64520 | | |
| | 40 | 60521 | | | 64521 | | |
| | 50 | 60522 | | | 64522 | | |
| | 60 | 60523 | | | 64523 | | |
| | 80 | 60524 | | | 64524 | | |
| | 100 | 60525 | | | | | |
| 2 x 72 | 120 | 60526 | | | | | |
| | 36 | 60534 | | | 64534 | | |
| | 40 | 60535 | | | 64535 | | |
| | 50 | 60536 | | | 64536 | | |
| | 60 | 60537 | | | 64537 | | |
| | 80 | 60538 | | | 64538 | | |
| 2 x 132 | 100 | 60539 | | | | | |
| | 120 | 60540 | | | | | |
| | 36 | 60576 | | | | | |
| | 40 | 60577 | | | | | |
| | 50 | 60578 | | | | | |
| | 60 | 60579 | | | | | |
| 2-1/2 x 14 | 80 | 60580 | | | | | |
| | 100 | 60581 | | | | | |
| | 120 | 60582 | | | | | |
| | 36 | | | 63280 | | | |
| | 40 | | 63381 | 63281 | | | |
| | 50 | | 63382 | 63282 | | | |
| 60 | | 63383 | 63283 | | | | |
| 80 | | 63384 | 63284 | | | | |
| 100 | | 63385 | | | | | |
| 120 | | 63386 | 63286 | | | | |

COATED
ABRASIVES

BELTS

BELTS



Benchstand Sander

Portable



Portable Sander

| Size | Grit | Closed Coat Aluminum Oxide | Closed Coat Aluminum Oxide | SAIT-Saver™ Closed Coat Aluminum Oxide | Open Coat Aluminum Oxide | Open Coat Aluminum Oxide | Closed Coat Zirconium | Closed Coat Zirconium | Closed Coat Silicon Carbide |
|------------|------|-----------------------------|------------------------------|--|--------------------------|---------------------------|-------------------------|--------------------------|-----------------------------|
| | | 1AX/2AX Blue Line™ Part No. | 1AX/2AX Quick Ship™ Part No. | LA-X Quick Ship™ Part No. | AO-X Blue Line™ Part No. | AO-X Quick Ship™ Part No. | Z-H Blue Line™ Part No. | Z-H Quick Ship™ Part No. | C-W Blue Line™ Part No. |
| 2-1/2 x 60 | 36 | | 61108 | | | | | 65108 | |
| | 40 | | 61109 | | | | | 65109 | |
| | 50 | | 61110 | | | | | 65110 | |
| | 60 | | 61111 | | | | | 65111 | |
| | 80 | | 61112 | | | | | 65112 | |
| | 100 | | 61113 | | | | | | |
| | 120 | | 61114 | | | | | | |
| 3 x 18 | 24 | 57100 | | | | 63230 | | | |
| | 36 | 57101 | | | | 63231 | | | |
| | 40 | 57102 | | | | 63232 | | | |
| | 50 | 57103 | | | | 63233 | | | |
| | 60 | 57104 | | | | 63234 | | | |
| | 80 | 57105 | | | | 63235 | | | |
| | 100 | 57106 | | | | 63236 | | | |
| | 120 | 57107 | | | | 63237 | | | |
| | 150 | 57108 | | | | 63238 | | | |
| | 180 | 57109 | | | | 63239 | | | |
| | 220 | 57110 | | | | | | | |
| | 320 | 57111 | | | | | | | |
| 3 x 21 | 24 | 57200 | | | 58160 | | 58111 | | |
| | 36 | 57201 | 60604 | | 58161 | | 58112 | | |
| | 40 | 57202 | 60605 | 55342 | 58162 | | 58113 | | |
| | 50 | 57203 | 60606 | 55343 | 58163 | | 58114 | | |
| | 60 | 57204 | 60607 | 55344 | 58164 | | 58115 | | 58200 |
| | 80 | 57205 | 60608 | 55345 | 58165 | | 58116 | | 58201 |
| | 100 | 57206 | 60609 | 55346 | 58166 | | | | 58202 |
| | 120 | 57207 | 60610 | 55347 | 58167 | | | | 58203 |
| | 150 | 57208 | | | 58168 | | | | 58204 |
| | 180 | 57209 | | | 58169 | | | | 58205 |
| | 220 | 57210 | | | | | | | 58206 |
| | 320 | 57211 | | | | | | | |
| 3 x 24 | 24 | 57500 | | | 58170 | | 58121 | | |
| | 36 | 57501 | 60646 | | 58171 | | 58122 | | |
| | 40 | 57502 | 60647 | 55352 | 58172 | | 58123 | | |
| | 50 | 57503 | 60648 | 55353 | 58173 | | 58124 | | |
| | 60 | 57504 | 60649 | 55354 | 58174 | | 58125 | | 58500 |
| | 80 | 57505 | 60650 | 55355 | 58175 | | 58126 | | 58501 |
| | 100 | 57506 | 60651 | 55356 | 58176 | | | | 58502 |
| | 120 | 57507 | 60652 | 55357 | 58177 | | | | 58503 |
| | 150 | 57508 | | | 58178 | | | | 58504 |
| | 180 | 57509 | | | 58179 | | | | 58505 |
| | 220 | 57510 | | | | | | | 58506 |
| | 320 | 57511 | | | | | | | |

1A-X/2A-X: Aluminum oxide, closed coat, X weight cotton. For general purpose sanding, grinding and finishing of ferrous and non-ferrous metals, wood, cast iron, ordinary and alloyed steels and stainless steel.

AO-X: Aluminum oxide, open coat, X weight cotton. For general purpose sanding and grinding where an open coat structure is needed. Best choice for soft woods, non-ferrous metals, aluminum, leather, rubber and other materials that have the tendency to load.

LA-X (SAIT-Saver™): Economy Aluminum oxide, closed coat, X-weight cotton. For low cost sanding and finishing of ordinary and alloyed steels, ferrous and non-ferrous metals, cast iron, and wood. A good choice where price and best value is the determining factor.

Z-H: Zirconium, closed coat, H weight waterproof polyester. Designed for aggressive grinding of ferrous and non-ferrous metals, cast iron, stainless steel, and aluminum. Backing can be used wet or dry.

C-W: Silicon Carbide, closed coat, X weight waterproof cotton. For grinding and finishing glass, aluminum, marble, hard cast iron, ceramics, non-ferrous metals, plastics, rubber and stone. Backing can be used wet or dry.



Benchstand Sander



Portable Sander

BELTS

Closed Coat Aluminum Oxide Closed Coat Aluminum Oxide SAIT-Saver™ Closed Coat Aluminum Oxide Open Coat Aluminum Oxide Open Coat Aluminum Oxide Closed Coat Zirconium Closed Coat Zirconium Closed Coat Silicon Carbide

| Size | Grit | 1AX/2AX Blue Line™ Part No. | 1AX/2AX Quick Ship™ Part No. | LA-X Quick Ship™ Part No. | AO-X Blue Line™ Part No. | AO-X Quick Ship™ Part No. | Z-H Blue Line™ Part No. | Z-H Quick Ship™ Part No. | C-W Blue Line™ Part No. |
|----------------|------|-----------------------------|------------------------------|---------------------------|--------------------------|---------------------------|-------------------------|--------------------------|-------------------------|
| 3 x 60 | 36 | | 60202 | | | | | | |
| | 40 | | 60203 | | | | | | |
| | 50 | | 60204 | | | | | | |
| | 60 | | 60205 | | | | | | |
| | 80 | | 60206 | | | | | | |
| | 100 | | 60207 | | | | | | |
| | 120 | | 60208 | | | | | | |
| 3 x 132 | 36 | | 60772 | | | | | 64772 | |
| | 40 | | 60773 | | | | | 64773 | |
| | 50 | | 60774 | | | | | 64774 | |
| | 60 | | 60775 | | | | | 64775 | |
| | 80 | | 60776 | | | | | 64776 | |
| | 100 | | 60777 | | | | | | |
| | 120 | | 60778 | | | | | | |
| 3-1/2 x 15-1/2 | 36 | | 61145 | | | | | | |
| | 40 | | 61146 | | | | | | |
| | 50 | | 61147 | | | | | | |
| | 60 | | 61148 | | | | | | |
| | 80 | | 61149 | | | | | | |
| | 100 | | 61150 | | | | | | |
| | 120 | | 61151 | | | | | | |
| 4 x 21 | 24 | 57600 | | | | 58180 | | | |
| | 36 | 57601 | | | | 58181 | | | |
| | 40 | 57602 | | | | 58182 | | | |
| | 50 | 57603 | | | | 58183 | | | |
| | 60 | 57604 | | | | 58184 | | | |
| | 80 | 57605 | | | | 58185 | | | |
| | 100 | 57606 | | | | 58186 | | | |
| | 120 | 57607 | | | | 58187 | | | |
| | 150 | 57608 | | | | 58188 | | | |
| | 180 | 57609 | | | | 58189 | | | |
| | 220 | 57610 | | | | | | | |
| | 240 | 57611 | | | | | | | |
| | 320 | 57613 | | | | | | | |
| 4 x 24 | 24 | 57900 | | | | 58190 | | 58131 | |
| | 36 | 57901 | 60842 | | | 58191 | | 58132 | |
| | 40 | 57902 | 60843 | 55362 | | 58192 | | 58133 | |
| | 50 | 57903 | 60844 | 55363 | | 58193 | | 58134 | |
| | 60 | 57904 | 60845 | 55364 | | 58194 | | 58135 | 58850 |
| | 80 | 57905 | 60846 | 55365 | | 58195 | | 58136 | 58851 |
| | 100 | 57906 | 60847 | 55366 | | 58196 | | | 58852 |
| | 120 | 57907 | 60848 | 55367 | | 58197 | | | 58853 |
| | 150 | 57908 | | | | 58198 | | | 58854 |
| | 180 | 57909 | | | | 58199 | | | 58855 |
| | 220 | 57910 | | | | | | | 58856 |
| | 240 | 57911 | | | | | | | |
| | 320 | 57913 | | | | | | | |
| 4 x 36 | 24 | | 60855 | | | | | 63240 | |
| | 36 | | 60856 | | | | | 63241 | |
| | 40 | | 60857 | 60663 | | | | 63242 | |
| | 50 | | 60858 | 60664 | | | | 63243 | |
| | 60 | | 60859 | 60665 | | | | 63244 | |
| | 80 | | 60860 | 60666 | | | | 63245 | |
| | 100 | | 60861 | 60667 | | | | 63246 | |
| | 120 | | 60862 | 60668 | | | | 63247 | |
| | 150 | | 60863 | | | | | 63248 | |
| | 180 | | 60864 | | | | | 63249 | |
| | 220 | | 60865 | | | | | | |
| | 240 | | 60866 | | | | | | |
| | 320 | | 60868 | | | | | | |
| 4 x 48 | 36 | | 60869 | | | | | | |
| | 40 | | 60870 | | | | | | |
| | 50 | | 60871 | | | | | | |
| | 60 | | 60872 | | | | | | |
| | 80 | | 60873 | | | | | | |
| | 100 | | 60874 | | | | | | |
| | 120 | | 60875 | | | | | | |
| 4 x 54 | 36 | | 60884 | | | | | | |
| | 40 | | 60885 | | | | | | |
| | 50 | | 60886 | | | | | | |
| | 60 | | 60887 | | | | | | |
| | 80 | | 60888 | | | | | | |
| | 100 | | 60889 | | | | | | |
| | 120 | | 60890 | | | | | | |

COATED ABRASIVES

BELTS

BELTS



Backstand Sander Benchstand Sander

| | | Closed Coat Aluminum Oxide | SAIT-Saver™ Closed Coat Aluminum Oxide | Open Coat Aluminum Oxide | Closed Coat Zirconium | Closed Coat Silicon Carbide |
|---------|---------|------------------------------------|--|---------------------------------|--------------------------------|-----------------------------------|
| Size | Grit | 1AX/2AX Quick Ship™ Part No. | LA-X Quick Ship™ Part No. | AO-X Quick Ship™ Part No. | Z-H Quick Ship™ Part No. | C-W Quick Ship™ Part No. |
| 4 x 60 | 36 | 60222 | | | | |
| | 40 | 60223 | | | | |
| | 50 | 60224 | | | | |
| | 60 | 60225 | | | | |
| | 80 | 60226 | | | | |
| | 100 | 60227 | | | | |
| | 120 | 60228 | | | | |
| 4 x 64 | 60 | | | | | 64200 |
| | 80 | | | | | 64201 |
| | 100 | | | | | 64202 |
| | 120 | | | | | 64203 |
| 4 x 106 | 60 | | | | | 64210 |
| | 80 | | | | | 64211 |
| | 100 | | | | | 64212 |
| | 120 | | | | | 64213 |
| 4 x 132 | 36 | 60982 | | | 64982 | |
| | 40 | 60983 | | | 64983 | |
| | 50 | 60984 | | | 64984 | |
| | 60 | 60985 | | | 64985 | 64220 |
| | 80 | 60986 | | | 64986 | 64221 |
| | 100 | 60987 | | | | 64222 |
| | 120 | 60988 | | | | 64223 |
| 6 x 48 | 24 | 61023 | | 63250 | | |
| | 36 | 61024 | | 63251 | 58142 | |
| | 40 | 61025 | 60683 | 63252 | 58143 | |
| | 50 | 61026 | 60684 | 63253 | 58144 | |
| | 60 | 61027 | 60685 | 63254 | 58145 | 58900 |
| | 80 | 61028 | 60686 | 63255 | 58146 | 58901 |
| | 100 | 61029 | 60687 | 63256 | | 58902 |
| | 120 | 61030 | 60688 | 63257 | | 58903 |
| | 150 | 61031 | | 63258 | | 58904 |
| | 180 | 61032 | | 63259 | | 58905 |
| | 220 | 61033 | | | | 58906 |
| | 240 | 61034 | | | | |
| | 320 | 61036 | | | | |
| | 6 x 132 | 36 | 61051 | | | |
| 40 | | 61052 | | | | |
| 50 | | 61053 | | | | |
| 60 | | 61054 | | | | |
| 80 | | 61055 | | | | |
| 100 | | 61056 | | | | |
| 120 | | 61057 | | | | |

1A-X/2A-X: Aluminum oxide, closed coat, X weight cotton. For general purpose sanding, grinding and finishing of ferrous and non-ferrous metals, wood, cast iron, ordinary and alloyed steels and stainless steel.

AO-X: Aluminum oxide, open coat, X weight cotton. For general purpose sanding and grinding where an open coat structure is needed. Best choice for soft woods, non-ferrous metals, aluminum, leather, rubber and other materials that have the tendency to load.

LA-X (SAIT-Saver™): Economy Aluminum oxide, closed coat, X-weight cotton. For low cost sanding and finishing of ordinary and alloyed steels, ferrous and non-ferrous metals, cast iron, and wood. A good choice where price and best value is the determining factor.

Z-H: Zirconium, closed coat, H weight waterproof polyester. Designed for aggressive grinding of ferrous and non-ferrous metals, cast iron, stainless steel, and aluminum. Backing can be used wet or dry.

C-W: Silicon Carbide, closed coat, X weight waterproof cotton. For grinding and finishing glass, aluminum, marble, hard cast iron, ceramics, non-ferrous metals, plastics, rubber and stone. Backing can be used wet or dry.

For other sizes, grits and materials, see page 70 for our extensive custom belt program

COATED
ABRASIVES

BELTS

CUSTOM BELTS

The United Abrasives custom belt program provides all the advantages of a leading abrasive manufacturer. Our broad selection of abrasive materials ensures that we have the right material for all metalworking and woodworking applications. From economy Aluminum Oxide to Zirconia Alumina, we have the material that you need to get the job done right. With the United Abrasives custom belt program, you get industry leading service and quality.

- Broad product offering
- Custom made to your exact length and width specifications
- Specify the material and size when ordering
- Allow for a quantity variance of plus or minus 10%

Note: Custom Belts are not returnable



MATERIAL APPLICATION

TECHNICAL INFORMATION

Zirconia Alumina Cloth

| | |
|---|--|
| Z-H 24-120 Grit Range Closed Coat | Zirconia alumina abrasive material on a H-weight, waterproof polyester backing for heavy duty grinding and finishing on ferrous and non-ferrous metals, cast iron, aluminum, and stainless steel. |
| 3Z-H 36-80 Grit Range Closed Coat | Zirconia alumina abrasive material on a H-weight, waterproof polyester backing with grinding aid. Excellent for grinding and finishing heat sensitive materials (stainless steel, titanium, etc.) and non-ferrous metals. |
| AZ-X 36-120 Grit Range Closed Coat | Zirconia alumina abrasive material on a X-weight, water-resistant polyester/cotton blended backing. For general purpose grinding and finishing on ferrous and non-ferrous metals, cast iron, aluminum, stainless steel and wood materials. |

Aluminum Oxide Cloth

| | |
|--|---|
| 1A-X/2A-X 24-400 Grit Range Closed Coat | Semi-friable(1A-X)/heat-treated(2A-X) aluminum oxide grain on a X-weight cotton backing. For general purpose grinding and finishing of ordinary and alloyed steels, ferrous and non-ferrous metals, cast iron and wood. |
| AO-X 24-180 Grit Range Open Coat | Semi-friable aluminum oxide grain on a X-weight cotton backing. For general purpose, open coat grinding, polishing and finishing of materials that have the tendency to load. For use on non-ferrous metals, aluminum and wood. |
| 3A-X 36-180 Grit Range Closed Coat | Semi-friable aluminum oxide grain with grinding aids on a X-weight cotton backing. Best for grinding and finishing heat sensitive materials (stainless steel, titanium, etc.) and non-ferrous metals. |
| 2A-H 24-120 Grit Range Closed Coat | Heat-treated, aluminum oxide grain on a H-weight, waterproof polyester backing. Excellent for heavy duty grinding and finishing ferrous and non-ferrous metals, cast iron, and aluminum. Excellent foundry belt material. |

Silicon Carbide Cloth

| | |
|--|---|
| C-W 60-400 Grit Range Closed Coat | Silicon carbide grain on waterproof, X-weight cotton backing. For grinding and finishing hard cast iron, aluminum, glass, ceramics, non-ferrous metals, plastics, rubber, marble and stone. |
|--|---|

FIBER DISCS INTRODUCTION

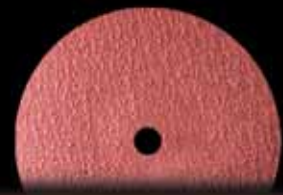

United Abrasives offers the most comprehensive fiber discs product offering in the industry (8 types). All SAIT fiber discs are made with the highest quality materials using a premium resin over resin construction. This uncompromising pursuit of quality is what makes SAIT fiber discs world-renowned.

MATERIAL APPLICATION TECHNICAL INFORMATION

Aluminum Oxide Fiber Discs - Page 72

| | |
|--------------------------------|---|
| 2A 16-120 Grit Range | Aluminum oxide, closed coat for general purpose grinding and finishing. |
| 3A 36-120 Grit Range | Aluminum oxide, closed coat with grinding aids to reduce heat and loading. Best for grinding and finishing heat sensitive materials and non-ferrous metals. |

Zirconium Fiber Discs - Page 73

| | |
|-------------------------------|---|
| Z 24-80 Grit Range | Zirconia alumina, closed coat for aggressive grinding and finishing. |
| 3Z 24-80 Grit Range | Zirconia alumina, closed coat with grinding aids to reduce heat and decrease loading. For aggressive grinding and finishing of heat sensitive materials and non-ferrous metals. |

Ceramic Fiber Discs - Page 74-75 **NEW!**

| | |
|-------------------------------|---|
| 8S 24-80 Grit Range | High performance ceramic grain, closed coat. Very uniform, high density, grain structure is extremely durable and self-sharpening for long life and cooler cut. |
| 9S 24-80 Grit Range | High performance ceramic grain, closed coat with grinding aids for reduced heat and decreased loading. Excels in heat sensitive materials and non-ferrous metals. |

Specialty Fiber Discs - Page 76

| | |
|--|--|
| AO Aluminum Oxide 16-36 Grit Range | Aluminum oxide, open coat for fast stock removal and reduced loading. |
| C Silicon Carbide 16-400 Grit Range | Silicon carbide, closed coat for performance grinding and finishing of glass, marble, ceramic, hard cast iron and ferrous/non-ferrous materials. |

Innovative Bulk Packaging (see picture on page 73)

Our unique bulk spindle packaging assures that each disc remains perfectly flat. The unique design offers the convenience of easy access and can be retightened to assure that your discs are flat when you need them.

SAIT-LOK™ Quick Change 5/8-11 Hub

The SAIT-LOK™ hub recesses into the center cavity of the backing pad to provide a flat profile, thus increasing usable abrasive surface area up to 100% to get the job done faster and cooler.

- Eliminates the need for wrenches and spanner nuts.
- Threaded backing pad must be used with SAIT-LOK™ hub. Available in Blue Line™ packaging only.



Angle Grinder

GENERAL PURPOSE



2A

- Aluminum oxide grain
- **General purpose**
- Closed coat structure for more material removal and better finishing

METAL Ferrous and/or non-ferrous metals

WOOD Wood

3A

- Premium aluminum oxide grain with grinding aid
- **Special aluminum oxide grain to reduce heat build up and reduce loading**
- Closed coat structure for more material removal and better finishing

STAINLESS Stainless steel, high tensile steel, titanium, aluminum

METAL Ferrous metals

| Size | Grit | Bulk | | Blue Line™ | | | SAIT-LOK™ | | |
|-------------|------|----------|----------|------------|----------|------------|-----------|----------|------------|
| | | Part No. | Part No. | Part No. | Part No. | Pk Per Box | Part No. | Part No. | Pk Per Box |
| | | 2A | 3A | 2A | 3A | | 2A | 3A | |
| 4 x 5/8 | 24 | 56024 | - | 50000 | - | 20 | | | |
| | 36 | 56036 | - | 50001 | - | 20 | | | |
| | 50 | 56050 | - | 50002 | - | 25 | | | |
| | 60 | 56060 | - | 50003 | - | 25 | | | |
| | 80 | 56080 | - | 50004 | - | 25 | | | |
| | 100 | 56100 | - | 50005 | - | 25 | | | |
| | 120 | 56120 | - | 50006 | - | 25 | | | |
| 4-1/2 x 7/8 | 16 | 51022 | - | 50008 | - | 20 | - | - | - |
| | 24 | 51024 | - | 50010 | - | 20 | 50120 | - | 15 |
| | 36 | 51036 | 52890 | 50011 | 50060 | 20 | 50121 | 50148 | 15 |
| | 50 | 51050 | 52891 | 50012 | 50061 | 25 | 50122 | 50149 | 15 |
| | 60 | 51060 | 52892 | 50013 | 50062 | 25 | 50123 | 50150 | 15 |
| | 80 | 51080 | 52893 | 50014 | 50063 | 25 | 50124 | 50151 | 15 |
| | 100 | 51100 | 52894 | 50015 | 50064 | 25 | 50125 | 50152 | 15 |
| 5 x 7/8 | 120 | 51120 | 52895 | 50016 | 50065 | 25 | 50126 | 50153 | 15 |
| | 16 | 53016 | - | 50018 | - | 20 | - | - | - |
| | 24 | 53024 | - | 50020 | - | 20 | 50127 | - | 15 |
| | 36 | 53036 | 52810 | 50021 | 50040 | 20 | 50128 | 50154 | 15 |
| | 50 | 53050 | 52811 | 50022 | 50041 | 25 | 50129 | 50155 | 15 |
| | 60 | 53060 | 52812 | 50023 | 50042 | 25 | 50130 | 50156 | 15 |
| | 80 | 53080 | 52813 | 50024 | 50043 | 25 | 50131 | 50157 | 15 |
| 7 x 7/8 | 100 | 53100 | 52814 | 50025 | 50044 | 25 | 50132 | 50158 | 15 |
| | 120 | 53120 | 52815 | 50026 | 50045 | 25 | 50133 | 50159 | 15 |
| | 16 | 57016 | - | 50030 | - | 20 | - | - | - |
| | 24 | 57024 | - | 50031 | - | 20 | 50134 | - | 15 |
| | 36 | 57036 | 52836 | 50032 | 50070 | 20 | 50135 | 50160 | 15 |
| | 50 | 57050 | 52850 | 50033 | 50071 | 25 | 50136 | 50161 | 15 |
| | 60 | 57060 | 52860 | 50034 | 50072 | 25 | 50137 | 50162 | 15 |
| 9-1/8 x 7/8 | 80 | 57080 | 52880 | 50035 | 50073 | 25 | 50138 | 50163 | 15 |
| | 100 | 57090 | 52100 | 50036 | 50074 | 25 | 50139 | 50164 | 15 |
| | 120 | 57120 | 52125 | 50037 | 50075 | 25 | 50140 | 50165 | 15 |
| | 16 | 58016 | - | 50080 | - | 20 | - | - | - |
| | 24 | 58024 | - | 50081 | - | 20 | 50141 | - | 15 |
| 9-1/8 x 7/8 | 36 | 58036 | - | 50082 | - | 20 | 50142 | - | 15 |
| | 50 | 58050 | - | 50083 | - | 25 | 50143 | - | 15 |
| | 60 | 58060 | - | 50084 | - | 25 | 50144 | - | 15 |
| | 80 | 58080 | - | 50085 | - | 25 | 50145 | - | 15 |
| | 100 | 58090 | - | 50086 | - | 25 | 50146 | - | 15 |
| | 120 | 58120 | - | 50087 | - | 25 | 50147 | - | 15 |

Tech INFO

- Resin over resin construction for a strong bond that is resistant to heat and moisture
- Vulcanized fiber backing for heavy duty sanding
- Available with SAIT-LOK™ quick change hub which extends disc life and requires fewer disc changes
- Available in bulk and Blue Line™ packaging

COATED ABRASIVES

FIBER DISCS

FIBER DISCS

Zirconium



Angle Grinder

Z

- Zirconium grain
- Closed coat structure for aggressive stock removal and long life

STAINLESS Stainless steel, high tensile alloys

METAL Ferrous and/or non-ferrous metals (iron, steel, welds, etc.)

3Z

- Premium zirconium grain with grinding aid
- Special zirconium grain to reduce heat build up and reduce loading
- Closed coat structure for very aggressive material removal

STAINLESS Stainless steel, high tensile steel, titanium, aluminum

METAL Ferrous metals

- SAIT-LOK™ is available in Blue Line™ package only
See page 142 for SAIT-LOK™ backing pads
- Spiralcool™ backing pads and disc holder available for standard discs
See page 142 for Spiralcool™ backing pads

Packaging

UPC bar coded Blue Line™ packaging or Industrial bulk pack of 100 pieces



Innovative Bulk Packaging
Fiber Spindle Keeps Discs Flat in Storage



Quick Tip

Use the Zirconium fiber disc for aggressive stock removal on carbon steel

| Size | Grit | Bulk | | Blue Line™ | | | SAIT-LOK™ | | |
|-------------|------|----------|-------|------------|-------|------------|-----------|-------|------------|
| | | Part No. | 3Z | Part No. | 3Z | Pk Per Box | Part No. | 3Z | Pk Per Box |
| 4-1/2 x 7/8 | 24 | 59224 | 58224 | 59424 | 58424 | 20 | 50166 | - | 15 |
| | 36 | 59236 | 58236 | 59436 | 58436 | 20 | 50167 | 50187 | 15 |
| | 50 | 59250 | 58250 | 59450 | 58450 | 25 | 50168 | 50188 | 15 |
| | 60 | 59260 | 58260 | 59460 | 58460 | 25 | 50169 | 50189 | 15 |
| | 80 | 59280 | 58280 | 59480 | 58480 | 25 | 50170 | 50190 | 15 |
| 5 x 7/8 | 24 | 59324 | 58324 | 59524 | 58524 | 20 | 50171 | - | 15 |
| | 36 | 59336 | 58336 | 59536 | 58536 | 20 | 50172 | 50192 | 15 |
| | 50 | 59350 | 58350 | 59550 | 58550 | 25 | 50173 | 50193 | 15 |
| | 60 | 59360 | 58360 | 59560 | 58560 | 25 | 50174 | 50194 | 15 |
| | 80 | 59380 | 58380 | 59580 | 58580 | 25 | 50175 | 50195 | 15 |
| 7 x 7/8 | 24 | 59624 | 58624 | 59724 | 58724 | 20 | 50176 | - | 15 |
| | 36 | 59636 | 58636 | 59736 | 58736 | 20 | 50177 | 50197 | 15 |
| | 50 | 59650 | 58650 | 59750 | 58750 | 25 | 50178 | 50198 | 15 |
| | 60 | 59660 | 58660 | 59760 | 58760 | 25 | 50179 | 50199 | 15 |
| | 80 | 59680 | 58680 | 59780 | 58780 | 25 | 50180 | 50200 | 15 |
| 9-1/8 x 7/8 | 24 | 59824 | - | 59924 | - | 20 | 50181 | - | 15 |
| | 36 | 59836 | - | 59936 | - | 20 | 50182 | - | 15 |
| | 50 | 59850 | - | 59950 | - | 25 | 50183 | - | 15 |
| | 60 | 59860 | - | 59960 | - | 25 | 50184 | - | 15 |
| | 80 | 59880 | - | 59980 | - | 25 | 50185 | - | 15 |

Tech INFO

- Resin over resin construction for a strong bond that is resistant to heat and moisture
- Vulcanized fiber backing for heavy duty sanding
- Available with SAIT-LOK™ quick change hub which extends disc life and requires fewer disc changes
- Available in bulk and Blue Line™ packaging

PREMIUM

COATED ABRASIVES

FIBER DISCS



NEW!



Saitech™ 8S Ceramic

- High performance, ceramic aluminum oxide grain, closed coat
- Very uniform, high density grain structure is extremely durable and self sharpening for long life and cooler cut
- Exceptional performance and value
- Available in bulk and Blue Line
- Excels on hard to grind alloys, carbon steel, cast iron, stainless steel, and non-ferrous metals

METAL Carbon steel, high tensile steel, titanium, cast iron

STAINLESS Ferrous and non-ferrous metals, stainless steel

Why use 8S?

SAITECH™ 8S excels when used to grind carbon steel and other ferrous metals. 8S ceramic performs exceptionally well when used under high operating pressure with a hard backing pad. 8S ceramic offers very fast stock removal and long life.

| Size | Grit | Bulk | Blue Line™ | | SAIT-LOK™ | |
|-------------|------|----------|------------|-------------|-----------|-------------|
| | | Part No. | Part No. | Qty Per Box | Part No. | Qty Per Box |
| 4-1/2 x 7/8 | 24 | 51242 | 50410 | 20 | 50238 | 300 |
| | 36 | 51243 | 50411 | 20 | 50239 | 300 |
| | 50 | 51244 | 50412 | 25 | 50240 | 300 |
| | 60 | 51245 | 50413 | 25 | 50241 | 300 |
| | 80 | 51246 | 50414 | 25 | 50242 | 300 |
| 5 x 7/8 | 24 | 51252 | 50420 | 20 | 50248 | 300 |
| | 36 | 51253 | 50421 | 20 | 50249 | 300 |
| | 50 | 51254 | 50422 | 25 | 50250 | 300 |
| | 60 | 51255 | 50423 | 25 | 50251 | 300 |
| | 80 | 51256 | 50424 | 25 | 50252 | 300 |
| 7 x 7/8 | 24 | 51292 | 50430 | 20 | 50258 | 300 |
| | 36 | 51293 | 50431 | 20 | 50259 | 300 |
| | 50 | 51294 | 50432 | 25 | 50260 | 300 |
| | 60 | 51295 | 50433 | 25 | 50261 | 300 |
| | 80 | 51296 | 50434 | 25 | 50262 | 300 |

Note: All SAIT-LOK™ Ceramic 8S fiber discs are made to order (must order in multiples of 300 pcs)

Packaging
UPC bar coded Blue Line™ packaging or Industrial bulk pack of 100 pieces

See page 142 for backing pads

Tech INFO

- Resin over resin construction for a strong bond that is resistant to heat and moisture
- Vulcanized fiber backing for heavy duty sanding
- Available with SAIT-LOK™ quick change hub which extends disc life and requires fewer disc changes
- Available in bulk spindle and Blue Line™ packaging

HIGH PERFORMANCE

COATED ABRASIVES

FIBER DISCS



NEW!

Saitech™ 9S Ceramic (with grinding aid)

- High performance, ceramic aluminum oxide grain, closed coat
- Grinding aids for reduced heat and decreased loading. Excels in heat sensitive materials (stainless steel, etc.) and non-ferrous metals (aluminum, etc.)
- Exceptional performance and value
- Excels on tough to grind materials

STAINLESS Stainless steel, high tensile steel, titanium, aluminum

METAL Ferrous metals and non-ferrous metals

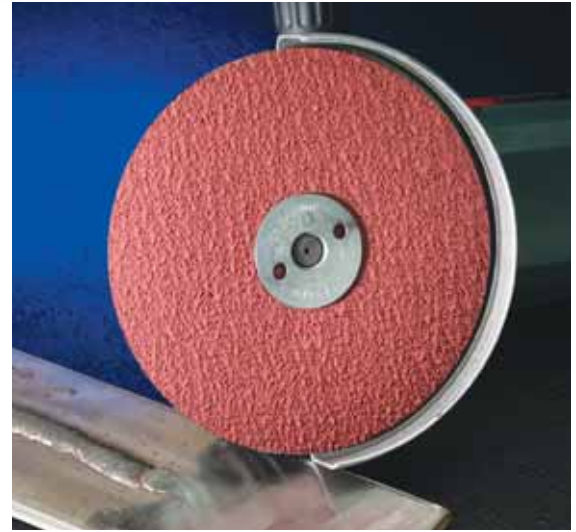

Grinds welds on stainless steel with no discoloration

HIGH PERFORMANCE

COATED ABRASIVES

Why use 9S?

SAITECH™ 9S ceramic fiber discs are designed to keep the material that the disc is being used on very cool to prevent burning, discoloration and distortion. 9S is the ideal product for end users who frequently grind sensitive materials like stainless steel, high nickel, chrome alloys and titanium. 9S also works very well on aluminum and non-ferrous metals as the grinding aids act as a lubricant to prevent loading.

| Size | Grit | Bulk | | Blue Line™ | | SAIT-LOK™ | |
|-------------|------|----------|----------|-------------|----------|-------------|----------|
| | | Part No. | Part No. | Qty Per Box | Part No. | Qty Per Box | Part No. |
| 4-1/2 x 7/8 | 24 | 51342 | 50510 | 20 | 50338 | 300 | |
| | 36 | 51343 | 50511 | 20 | 50339 | 300 | |
| | 50 | 51344 | 50512 | 25 | 50340 | 300 | |
| | 60 | 51345 | 50513 | 25 | 50341 | 300 | |
| | 80 | 59113 | 56313 | 25 | 50342 | 300 | |
| 5 x 7/8 | 24 | 51352 | 50520 | 20 | 50348 | 300 | |
| | 36 | 51353 | 50521 | 20 | 50349 | 300 | |
| | 50 | 51354 | 50522 | 25 | 50350 | 300 | |
| | 60 | 51355 | 50523 | 25 | 50351 | 300 | |
| | 80 | 59133 | 56333 | 25 | 50352 | 300 | |
| 7 x 7/8 | 24 | 51372 | 50530 | 20 | 50358 | 300 | |
| | 36 | 51373 | 50531 | 20 | 50359 | 300 | |
| | 50 | 51374 | 50532 | 25 | 50370 | 300 | |
| | 60 | 51375 | 50533 | 25 | 50371 | 300 | |
| | 80 | 59153 | 56353 | 25 | 50372 | 300 | |

Note: All SAIT-LOK™ Ceramic 9S fiber discs are made to order (must order in multiples of 300 pcs)

Packaging
UPC bar coded Blue Line™ packaging or Industrial bulk pack of 100 pieces

See page 142 for backing pads

FIBER DISCS



- Resin over resin construction for a strong bond that is resistant to heat and moisture
- Vulcanized fiber backing for heavy duty sanding
- Available with SAIT-LOK™ quick change hub which extends disc life and requires fewer disc changes
- Available in bulk spindle and Blue Line™ packaging



SPECIALTY

COATED ABRASIVES

FIBER DISCS



AO

- Aluminum oxide grain
- Open coat structure prevents loading
- Fast material removal

METAL Ferrous and/or non-ferrous metals (iron, steel, copper, aluminum, etc.)

WOOD Wood, fiberglass

C

- Silicon carbide grain
- Closed coat structure for more material removal

CONCRETE Glass, marble, ceramic, hard cast iron

METAL Ferrous and/or non-ferrous metals



Quick Tip

Use Spiralcool™ backing pads to extend disc life 30% to 50%

Note: Fiber Discs must always be used with a backing pad.

| Size | Grit | Bulk Part No. | | Blue Line™ Part No. | | Pk Per Box |
|---------|------|---------------|-------|---------------------|-------|------------|
| | | AO | C | AO | C | |
| 7 x 7/8 | 16 | 52716 | 54016 | 50050 | 50100 | 20 |
| | 24 | 52724 | 54024 | 50051 | 50101 | 20 |
| | 36 | 52736 | 54036 | 50052 | 50102 | 20 |
| | 50 | - | 54050 | - | 50103 | 25 |
| | 60 | - | 54060 | - | 50104 | 25 |
| | 80 | - | 54080 | - | 50105 | 25 |
| | 100 | - | 54100 | - | 50106 | 25 |
| | 120 | - | 54120 | - | 50107 | 25 |
| | 150 | - | 54150 | - | 50108 | 25 |
| | 180 | - | 54180 | - | 50109 | 25 |
| | 220 | - | 54220 | - | 50110 | 25 |
| | 320 | - | 54320 | - | 50112 | 25 |
| | 400 | - | 54400 | - | 50113 | 25 |

Packaging

UPC bar coded Blue Line™ packaging or Industrial bulk pack of 100 pieces

See page 142 for backing pads

Tech INFO

- Resin over resin construction for a strong bond that is resistant to heat and moisture
- Vulcanized fiber backing for heavy duty sanding
- Available in bulk and Blue Line™ packaging

LAMINATED DISCS

Heavy Duty



Portable Grinder

Triple laminated construction for severe pressure applications where conventional laminated discs have too much flex. Excellent for edge grinding, deburring, and weld preparation and removal.

SAIT-LOK™



Improved nylon composite won't bend or break during aggressive applications. Uses the same backing pad as conventional laminated discs.

SAIT-LOK-R™



Nylon screw threaded hub for easy mounting to the backing pad



NEW!

2A-H

- Aluminum oxide grain
- Fast stock removal
- Excellent edge grain retention

METAL Ferrous and/or non-ferrous metals

WOOD Wood, plastic, fiberglass, etc

Z-H

- High performance Zirconium grain
- Extremely fast stock removal and long life

METAL Ferrous and/or non-ferrous metals

STAINLESS Stainless steel, high tensile alloys

| Size | Grit | SAIT-LOK™ Part No. | | SAIT-LOK-R™ Part No. | | Qty Per Box |
|------|------|--------------------|-------|----------------------|-------|-------------|
| | | 2A-H | Z-H | 2A-H | Z-H | |
| 2" | 24 | 52320 | 55420 | 50320 | 55450 | 100 |
| | 36 | 52321 | 55421 | 50321 | 55451 | 100 |
| | 50 | 52322 | 55422 | 50322 | 55452 | 100 |
| | 60 | 52323 | 55423 | 50323 | 55453 | 100 |
| | 80 | 52324 | 55424 | 50324 | 55454 | 100 |
| 3" | 24 | 52330 | 55430 | 50330 | 55460 | 50 |
| | 36 | 52331 | 55431 | 50331 | 55461 | 50 |
| | 50 | 52332 | 55432 | 50332 | 55462 | 50 |
| | 60 | 52333 | 55433 | 50333 | 55463 | 50 |
| | 80 | 52334 | 55434 | 50334 | 55464 | 50 |



Heavy Duty Discs

Stiffer construction assures fast grinding performance
Very durable edge performance and long life



Conventional Discs

See page 145 for backing pads



- Triple lamination construction for severe duty applications where traditional discs fray
- Quick change backings make for fast easy disc changes and less downtime
- Universal style backings fit most major backing pad brands on the market

HEAVY DUTY

COATED ABRASIVES

LAMINATED DISCS



Portable Grinder

GENERAL PURPOSE



SAIT-LOK™

All-metal attachment on disc ensures a secure fit to the backing pad
(see page 79 for photo)

SAIT-LOK-R™

Nylon screw threaded hub for easy mounting to the backing pad

See page 145 for backing pads

2A

- Aluminum oxide grain
- General purpose, long life
- Easy disc changes by twisting to unlock backing pad

- METAL** Ferrous and/or non-ferrous metals
- WOOD** Wood, plastic, fiberglass, etc.

3A

- Premium aluminum oxide grain with grinding aid
- Cooling agents for cool cutting and long life
- Fast stock removal
- Easy disc changes by twisting to unlock backing pad

STAINLESS Stainless steel, high tensile steel, titanium

METAL Ferrous and/or non-ferrous metals

QT Quick Tip
Use 3A or 3Z for top performance on stainless steel and aluminum

| Size | Grit | SAIT-LOK™ Part No. | | SAIT-LOK-R™ Part No. | | Qty Per Box |
|--------|------|--------------------|-------|----------------------|-------|-------------|
| | | 2A | 3A | 2A | 3A | |
| 1" | 36 | 52208 | 50208 | - | - | 100 |
| | 40 | 52209 | 50209 | - | - | 100 |
| | 50 | 52210 | 50210 | - | - | 100 |
| | 60 | 52211 | 50211 | - | - | 100 |
| | 80 | 52212 | 50212 | - | - | 100 |
| | 100 | 52213 | 50213 | - | - | 100 |
| | 120 | 52214 | 50214 | - | - | 100 |
| 1-1/2" | 36 | 52215 | 50215 | 52264 | 50264 | 100 |
| | 40 | 52216 | 50216 | 52265 | 50265 | 100 |
| | 50 | 52217 | 50217 | 52266 | 50266 | 100 |
| | 60 | 52218 | 50218 | 52267 | 50267 | 100 |
| | 80 | 52219 | 50219 | 52268 | 50268 | 100 |
| | 100 | 52220 | 50220 | 52269 | 50269 | 100 |
| | 120 | 52221 | 50221 | 52270 | 50270 | 100 |
| 2" | 36 | 52222 | 50222 | 52271 | 50271 | 100 |
| | 40 | 52223 | 50223 | 52272 | 50272 | 100 |
| | 50 | 52224 | 50224 | 52273 | 50273 | 100 |
| | 60 | 52225 | 50225 | 52274 | 50274 | 100 |
| | 80 | 52226 | 50226 | 52275 | 50275 | 100 |
| | 100 | 52227 | 50227 | 52276 | 50276 | 100 |
| | 120 | 52228 | 50228 | 52277 | 50277 | 100 |
| 3" | 36 | 52229 | 50229 | 52278 | 50278 | 50 |
| | 40 | 52230 | 50230 | 52279 | 50279 | 50 |
| | 50 | 52231 | 50231 | 52280 | 50280 | 50 |
| | 60 | 52232 | 50232 | 52281 | 50281 | 50 |
| | 80 | 52233 | 50233 | 52282 | 50282 | 50 |
| | 100 | 52234 | 50234 | 52283 | 50283 | 50 |
| | 120 | 52235 | 50235 | 52284 | 50284 | 50 |

Tech INFO

- 2-ply construction is rugged enough for contoured surfaces or flat surfaces
- Quick-change backings make for fast easy disc changes and less downtime
- Universal backings fit most major backing pad brands on the market

COATED ABRASIVES

LAMINATED DISCS

LAMINATED DISCS

Zirconium



Portable Grinder

SAIT-LOK™



All-metal attachment on disc ensures a secure fit to the backing pad

SAIT-LOK-R™



Nylon screw threaded hub for easy mounting to the backing pad

See page 145 for backing pads



Z Now in 24 Grit!

- Premium zirconium grain
- **Very fast stock removal, long life**
- Easy disc changes by twisting to unlock backing pad

STAINLESS Stainless steel, high tensile alloys

METAL Ferrous and/or non-ferrous metals (iron, steel, welds, etc.)

3Z

- Premium zirconium grain with grinding aid
- Cooling agents for cool cutting and long life
- **Very fast stock removal, no discoloration**
- Easy disc changes by twisting to unlock backing pad

STAINLESS Stainless steel, high tensile steel, titanium

METAL Ferrous and/or non-ferrous metals



| Size | Grit | SAIT-LOK™ Part No. | | SAIT-LOK-R™ Part No. | | Qty Per Box |
|--------|------|--------------------|-------|----------------------|-------|-------------|
| | | Z | 3Z | Z | 3Z | |
| 1-1/2" | 36 | 55215 | 56215 | 55264 | 56264 | 100 |
| | 40 | 55216 | 56216 | 55265 | 56265 | 100 |
| | 50 | 55217 | 56217 | 55266 | 56266 | 100 |
| | 60 | 55218 | 56218 | 55267 | 56267 | 100 |
| | 80 | 55219 | 56219 | 55268 | 56268 | 100 |
| | 24 | 55221 | - | 55270 | - | 100 |
| 2" | 36 | 55222 | 56222 | 55271 | 56271 | 100 |
| | 40 | 55223 | 56223 | 55272 | 56272 | 100 |
| | 50 | 55224 | 56224 | 55273 | 56276 | 100 |
| | 60 | 55225 | 56225 | 55274 | 56274 | 100 |
| | 80 | 55226 | 56226 | 55275 | 56275 | 100 |
| | 24 | 55228 | - | 55277 | - | 50 |
| 3" | 36 | 55229 | 56229 | 55278 | 56278 | 50 |
| | 40 | 55230 | 56230 | 55279 | 56279 | 50 |
| | 50 | 55231 | 56231 | 55280 | 56280 | 50 |
| | 60 | 55232 | 56232 | 55281 | 56281 | 50 |
| | 80 | 55233 | 56233 | 55282 | 56282 | 50 |



- 2-ply construction is rugged enough for contour surfaces or flat surfaces
- Quick-change backings make for fast easy disc changes and less downtime
- Universal backings fit most major backing pad brands on the market

PREMIUM

COATED ABRASIVES

LAMINATED DISCS

PAPER & CLOTH DISCS

INTRODUCTION

SAIT paper and cloth discs are made with the highest quality raw materials using a premium resin over resin construction. This coupled with our high quality fastening systems allows for product performance that is second to none.

Paper Disc Materials

| MATERIAL DESCRIPTION | TECHNICAL INFORMATION |
|---|---|
| Zirconium | |
| Z-F Heavy Duty Paper Discs 40-120 Grit Range F-weight paper Closed Coat | Best choice for aggressive sanding and preparation, and stock removal. Zirconium grain for aggressive material removal and long life. Heavy, F-weight paper prevents torn edges, which produce deep, uneven random scratches. Available in PSA and hook and loop fastening systems. See page 83, 85 for details |
| Aluminum Oxide | |
| A-E Heavy Duty Paper Discs 40-120 Grit Range E-weight paper Open Coat | For aggressive sanding and preparation, and stock removal. Aluminum Oxide grain for material removal, long life and finishing. E-weight paper reduces torn edges, which produce deep, uneven random scratches. Available in PSA and hook and loop fastening systems. See page 83, 85 for details |
| 4S/4V Premium Stearate Paper 80-1500 Grit Range C-weight paper Open Coat | Premium stearate coating and open coat structure lubricates and prevents loading for long life and aggressive cutting. Available in C-weight, low flexibility. Available in PSA and hook and loop fastening systems. See pages 81, 82 and 84 for details. |
| 3S Stearate Paper 80-600 Grit Range C-weight paper Open Coat | Stearate coating and open coat structure lubricates and prevents loading. Available in C-weight, normal flexibility. Available in PSA and hook and loop fastening systems in individual discs and in PSA disc rolls. See pages 81, 82 and 84 for details. |
| Silicon Carbide | |
| C-E and C-F Paper Discs 40-1200 Grit Range E and F weight paper Closed Coat | Premium Silicon Carbide paper for aggressive sanding and finishing on granite, marble, fiberglass, solid surface materials, ceramics, concrete, plastics and cast iron materials. Heavy-duty paper prevents torn edges, which can produce deep, uneven scratches. Available in hook and loop fastening system. See page 85 for details. |
| Silicon Carbide Stearate Paper 80-400 Grit Range B and D weight paper Open Coat | Stearate coating and open coat structure lubricates and prevents loading for fast cutting. Available in PSA disc rolls. See page 81 for details. |

Cloth Disc Materials

| MATERIAL DESCRIPTION | TECHNICAL INFORMATION |
|---|--|
| Zirconia Alumina | |
| Z-X 40-80 Grit Range X-weight cloth Closed Coat | Zirconia alumina, X-weight cotton backing for superior grinding and finishing performance. Hot melt adhesive provides excellent adhesion while allowing for easy removal. Available in the most popular sizes and grits. See page 86 for more information. |
| Aluminum Oxide | |
| TA-X 24-320 Grit Range X-weight cloth Closed Coat | Aluminum oxide, X-weight cotton backing for grinding and finishing performance. Hot melt adhesive provides excellent adhesion while allowing for easy removal. Available in the most popular sizes and grits. See page 87 for more information. |

COATED ABRASIVES

PAPER DISCS PSA DISC ROLLS

Stearated



Disc Sander

4S Premium Stearated Aluminum Oxide

- EXCELS ON PAINTED AND PRIMED SURFACES
- Our best performing, longest lasting paper disc
- Long lasting performance and fast removal rates for fine finishing of auto body, wood, metal, and marine applications
- Premium Aluminum Oxide grain
- Premium Stearate coating and open coat structure lubricates and prevents loading - For dry use only
- Available in weights: "C" medium-weight, low flexibility

WOOD Body filler, paint, primers, plastics, wood and fiberglass

METAL Ferrous and/or non-ferrous metals

Packaging

PSA Disc Rolls: 100 pcs/roll
4 rolls/box

see page 144 for backing pads



| Size | Grit | PSA Disc Rolls Part No |
|----------|-------|------------------------|
| 5" 4S | 80C | 37800 |
| | 100C | 37801 |
| | 120C | 37802 |
| | 150C | 37803 |
| | 180C | 37804 |
| | 220C | 37805 |
| | 240C | 37806 |
| | 280C | 37807 |
| | 320C | 37808 |
| 400C | 37809 | |
| 6" 4S | 80C | 37900 |
| | 100C | 37901 |
| | 120C | 37902 |
| | 150C | 37903 |
| | 180C | 37904 |
| | 220C | 37905 |
| | 240C | 37906 |
| | 280C | 37907 |
| | 320C | 37908 |
| 400C | 37909 | |

| Size | Grit | PSA Disc Rolls Part No |
|----------|-------|------------------------|
| 5" 3S | 80C | 36800 |
| | 100C | 36801 |
| | 120C | 36802 |
| | 150C | 36803 |
| | 180C | 36804 |
| | 220C | 36805 |
| | 320C | 36808 |
| | 400C | 36809 |
| | 500C | 36810 |
| 600C | 36811 | |
| 6" 3S | 80C | 36900 |
| | 100C | 36901 |
| | 120C | 36902 |
| | 150C | 36903 |
| | 180C | 36904 |
| | 220C | 36905 |
| | 320C | 36908 |
| | 400C | 36909 |
| | 500C | 36910 |
| 600C | 36911 | |

3S Stearated Aluminum Oxide

- EXCELS ON WOOD AND BARE METAL SURFACES
- Aluminum oxide grain - For dry use only
- Stearate coating and open coat structure lubricates and prevents loading
- Available in weights: "C" medium-weight, average flexibility

WOOD Body filler, paint, primers, plastics, wood and fiberglass

METAL Ferrous and/or non-ferrous metals

Silicon Carbide Stearate

- OUR BEST ECONOMY DISC
- Open coat structure prevents loading; Use dry only
- For automotive body work
- For removing varnish from wood or sanding fiberglass in the marine industry

WOOD Body filler, paint, fiberglass, etc.

METAL Ferrous and/or non-ferrous materials

- Available with or without vacuum holes for use on random orbital or low speed DA sanders
- Available weights: "B" - light weight, high flexibility
"D" - heavy weight, low flexibility

| Size | Grit | Part No. w/o vacuum holes | Part No. with vacuum holes |
|------|------|---------------------------|----------------------------|
| 5" | 80D | 36500 | 36510 |
| | 100B | 36501 | 36511 |
| | 120B | 36502 | 36512 |
| | 150B | 36503 | 36513 |
| | 180B | 36504 | 36514 (5 vacuum holes) |
| | 220B | 36505 | 36515 |
| | 240B | 36506 | 36516 |
| | 320B | 36508 | 36518 |
| | 400B | 36509 | 36519* |
| | 6" | 80D | 36600 |
| 100B | | 36601 | 36611 |
| 120B | | 36602 | 36612 |
| 150B | | 36603 | 36613 |
| 180B | | 36604 | 36614 (6 vacuum holes) |
| 220B | | 36605 | 36615 |
| 240B | | 36606 | 36616 |
| 320B | | 36608 | 36618 |
| 400B | | 36609 | 36619 |

Packaging 125 pieces/box/roll
*100 pieces/box/roll



- Strong resin over resin bond construction is resistant to heat and moisture
- Special sharp and durable aluminum oxide grain cuts fast and is long lasting
- PSA discs rolls are perforated for easy disc tear away from roll

COATED
ABRASIVES

PAPER DISCS

Stearated



Disc Sander

PAPER DISCS INDIVIDUAL PSA

4S/4V Premium Stearated Aluminum Oxide

- EXCELS ON PAINTED AND PRIMED SURFACES
- Our best performing, longest lasting paper disc
- Long lasting performance and fast removal rates for fine finishing of auto body, wood, metal, and marine applications
- Premium Aluminum Oxide grain - For dry use only
- Premium Stearate coating and open coat structure lubricates and prevents loading
- Available in weights: "C" medium-weight, low flexibility

WOOD Body filler, paint, primers, plastics, wood and fiberglass

METAL Ferrous and/or non-ferrous metals

| Size | Grit | PSA Discs Part No. w/o vac. holes |
|------|------|-----------------------------------|
| 5" | 80C | 37505 |
| | 100C | 37506 |
| | 120C | 37507 |
| | 150C | 37508 |
| | 180C | 37509 |
| | 220C | 37510 |
| 6" | 80C | 37511 |
| | 100C | 37605 |
| | 120C | 37606 |
| | 150C | 37607 |
| | 180C | 37608 |
| | 220C | 37609 |



Quick Tip

Release paper keeps PSA discs clean in a dusty environment

Packaging

PSA individual: 100/box

see page 144 for backing pads

3S Stearate Aluminum Oxide

- EXCELS ON WOOD AND BARE METAL SURFACES
- Aluminum oxide grain - For dry use only
- Stearate coating and open coat structure lubricates and prevents loading
- Fine finishing of wood, metal, auto body and marine applications
- Available in weights: "C" medium-weight, average flexibility

WOOD Body filler, paint, primers, plastics, wood and fiberglass

METAL Ferrous and/or non-ferrous metals

| Size | Grit | PSA Discs Part No. w/o vac. holes |
|------|------|-----------------------------------|
| 5" | 80C | 36520 |
| | 100C | 36521 |
| | 120C | 36522 |
| | 150C | 36523 |
| | 180C | 36524 |
| | 220C | 36525 |
| 6" | 80C | 36620 |
| | 100C | 36621 |
| | 120C | 36622 |
| | 150C | 36623 |
| | 180C | 36624 |
| | 220C | 36625 |

Tech INFO

- Special sharp and durable premium aluminum oxide grain cuts fast and is long lasting
- Pressure sensitive adhesive (PSA) backing allows for quick changes
- PSA discs are tabbed for easy removal of release paper

COATED
ABRASIVES

PAPER DISCS

PAPER DISCS INDIVIDUAL PSA

Heavy Duty



Zirconium Paper Discs - Z-F (Premium)

- Best choice for aggressive sanding and preparation, and stock removal
- Zirconium grain for aggressive material removal and long life
- Heavy, F-weight paper prevents torn edges which produce deep, uneven random scratches

METAL Ferrous and non-ferrous metals

WOOD Wood

Aluminum Oxide Paper Discs - A-E

- For aggressive sanding and preparation, and stock removal
- Aluminum Oxide grain for material removal, long life and finishing
- E-weight paper reduces torn edges which produce deep, uneven random scratches

WOOD Wood, auto body applications, and fiberglass

METAL Ferrous and non-ferrous metals

| Size | Grit | ZF - Zirconium | AE - Aluminum Oxide |
|------|------|----------------|---------------------|
| | | Part No. | Part No. |
| 5" | 40 | 34110 | 34150 |
| | 60 | 34112 | 34152 |
| | 80 | 34113 | 34153 |
| | 120 | 34115 | 34155 |
| 6" | 40 | 34130 | 34170 |
| | 60 | 34132 | 34172 |
| | 80 | 34133 | 34173 |
| | 120 | 34135 | 34175 |
| 8" | 40 | 34140 | - |
| | 80 | 34143 | - |

Packaging

5" and 6"
PSA: 50/box

8"
PSA: 25/box

see page 144 for backing pads



Quick Tip

Release paper keeps PSA discs clean in a dusty environment



COATED
ABRASIVES

PAPER DISCS

Tech INFO

- Special sharp and durable premium aluminum oxide grain cuts fast and is long lasting
- Pressure sensitive adhesive (PSA) allows for quick changes
- PSA discs are tabbed for easy removal of release paper

Stearated



Disc Sander

PAPER DISCS HOOK & LOOP

4S/4V Premium Stearated Aluminum Oxide

- EXCELS ON PAINTED AND PRIMED SURFACES
- Our best performing, longest lasting paper disc
- Long lasting performance and fast removal rates for fine finishing of auto body, wood, metal, and marine applications
- Premium Aluminum Oxide grain - for dry use only
- Premium Stearate coating and open coat structure lubricates and prevents loading

Packaging
50 pieces per box

See page 144 for backing pads now also available with vacuum holes

"C" medium-weight, low flexibility

WOOD Body filler, paint, primers, plastics, wood and fiberglass

METAL Ferrous and/or non-ferrous metals

4S/4V Hook & Loop Discs

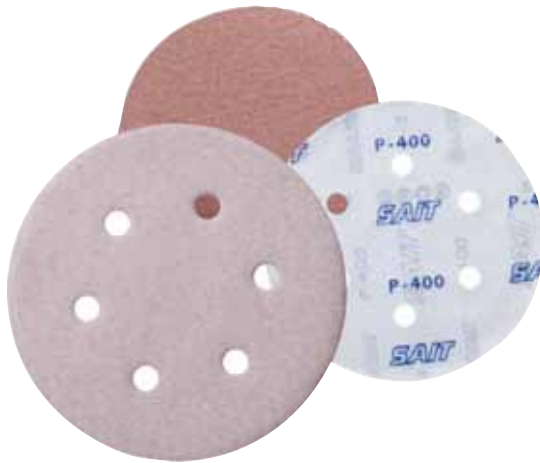

| Size | Grit | 4S/4V Saitech™ Hook & Loop Discs | | | |
|-------|-------|----------------------------------|--------------------------|--------------------------|--------------------------|
| | | Part No. w/o vac. holes | Part No. w/ 5 vac. holes | Part No. w/ 6 vac. holes | Part No. w/ 8 vac. holes |
| 5" | 80C | 37515 | 37525 | - | 37535 |
| | 100C | 37516 | 37526 | - | 37536 |
| | 120C | 37517 | 37527 | - | 37537 |
| | 150C | 37518 | 37528 | - | 37538 |
| | 180C | 37519 | 37529 | - | 37539 |
| | 220C | 37520 | 37530 | - | 37540 |
| | 240C | 37562 | - | - | - |
| | 280C | 37563 | - | - | - |
| | 320C | 37521 | 37531 | - | 37541 |
| | 400C | 37522 | 37532 | - | 37542 |
| | 500C | 37523 | - | - | - |
| | 600C | 37524 | - | - | - |
| | 800C | 37550 | 37554 | - | 37543 |
| | 1000C | 37551 | 37555 | - | 37544 |
| | 1200C | 37552 | 37556 | - | 37545 |
| 1500C | 37553 | 37557 | - | 37546 | |
| 6" | 80C | 37615 | - | 37635 | - |
| | 100C | 37616 | - | 37636 | - |
| | 120C | 37617 | - | 37637 | - |
| | 150C | 37618 | - | 37638 | - |
| | 180C | 37619 | - | 37639 | - |
| | 220C | 37620 | - | 37640 | - |
| | 240C | 37650 | - | - | - |
| | 280C | 37651 | - | - | - |
| | 320C | 37621 | - | 37641 | - |
| | 400C | 37622 | - | 37642 | - |
| | 500C | 37623 | - | - | - |
| | 600C | 37624 | - | - | - |
| | 800C | 37625 | - | 37643 | - |
| | 1000C | 37626 | - | 37644 | - |
| | 1200C | 37627 | - | 37645 | - |
| 1500C | 37628 | - | 37646 | - | |

3S Hook & Loop Discs

| Size | Grit | 3S Saitech™ Hook & Loop Discs | | | |
|------|------|-------------------------------|--------------------------|--------------------------|--------------------------|
| | | Part No. w/o vac. holes | Part No. w/ 5 vac. holes | Part No. w/ 6 vac. holes | Part No. w/ 8 vac. holes |
| 5" | 80C | 36540 | 36550 | - | 36560 |
| | 100C | 36541 | 36551 | - | 36561 |
| | 120C | 36542 | 36552 | - | 36562 |
| | 150C | 36543 | 36553 | - | 36563 |
| | 180C | 36544 | 36554 | - | 36564 |
| | 220C | 36545 | 36555 | - | 36565 |
| | 320C | 36548 | 36558 | - | 36568 |
| | 80C | 36640 | - | 36650 | - |
| 6" | 100C | 36641 | - | 36651 | - |
| | 120C | 36642 | - | 36652 | - |
| | 150C | 36643 | - | 36653 | - |
| | 180C | 36644 | - | 36654 | - |
| | 220C | 36645 | - | 36655 | - |
| | 320C | 36648 | - | 36658 | - |

3S Stearated Aluminum Oxide

- EXCELS ON WOOD AND BARE METAL SURFACES
- Aluminum oxide grain - for dry use only
- Stearate coating and open coat structure lubricates and prevents loading
- Fine finishing of wood, metal, auto body and marine applications
- "C" medium-weight, average flexibility

WOOD Body filler, paint, primers, plastics, wood and fiberglass

METAL Ferrous and/or non-ferrous metals



- Hook and loop fastening system allows for quick changes and less downtime
- Available with or without vacuum holes for use on random orbital or low speed DA sanders with capture systems
- Strong resin over resin bond construction is resistant to heat and moisture
- This special sharp and durable aluminum oxide grain cuts fast and lasts long

COATED
ABRASIVES

PAPER DISCS

PAPER DISCS HOOK & LOOP

Heavy Duty



Disc Sander

Zirconium Paper Discs - Z-F (Premium)

- Best choice for aggressive sanding and preparation, and stock removal
- Zirconium grain for aggressive material removal and long life
- Heavy, F-weight paper prevents torn edges which produce deep, uneven random scratches

METAL Ferrous and non-ferrous metals

WOOD Wood

Aluminum Oxide Paper Discs - A-E

- For aggressive sanding and preparation, and stock removal
- Aluminum Oxide grain for material removal, long life and finishing
- E-weight paper reduces torn edges which produce deep, uneven random scratches

WOOD Wood, auto body applications, and fiberglass

METAL Ferrous and non-ferrous metals

Z-F Zirconium Hook & Loop

| Size | Z-F Zirconium | |
|------|---------------|----------|
| | Grit | Part No. |
| 5" | 40 | 34210 |
| | 60 | 34212 |
| | 80 | 34213 |
| | 120 | 34215 |
| 6" | 40 | 34230 |
| | 60 | 34232 |
| | 80 | 34233 |
| | 120 | 34235 |
| 8" | 40 | 34240 |
| | 80 | 34243 |

Packaging

50 pieces per box

See page 144 for backing pads now also available with vacuum holes

A-E Aluminum Oxide Hook & Loop

| Size | Grit | AE - Aluminum Oxide | | | |
|------|------|-----------------------------|------------------------------|------------------------------|------------------------------|
| | | H&L Part No. w/o vac. holes | H&L Part No. w/ 5 vac. holes | H&L Part No. w/ 6 vac. holes | H&L Part No. w/ 8 vac. holes |
| 5" | 40 | 34250 | 34280 | - | 34290 |
| | 60 | 34252 | 34282 | - | 34292 |
| | 80 | 34253 | 34283 | - | 34293 |
| | 120 | 34255 | 34285 | - | 34295 |
| 6" | 40 | 34270 | - | 34310 | - |
| | 60 | 34272 | - | 34312 | - |
| | 80 | 34273 | - | 34313 | - |
| | 120 | 34275 | - | 34315 | - |

Silicon Carbide Paper Discs

| Size | Grit | Hook & Loop Part No. |
|------|-------|----------------------|
| 5" | 40 | 34510 |
| | 60 | 34512 |
| | 80 | 34513 |
| | 100 | 34514 |
| | 120 | 34515 |
| | 150 | 34516 |
| | 180 | 34517 |
| | 220 | 34518 |
| | 320 | 34521 |
| | 400 | 34522 |
| | 500 | 34523 |
| | 600 | 34524 |
| 6" | 800 | 34525 |
| | 1200 | 34527 |
| | 40 | 34610 |
| | 60 | 34612 |
| | 80 | 34613 |
| | 100 | 34614 |
| | 120 | 34615 |
| | 150 | 34616 |
| | 180 | 34617 |
| | 220 | 34618 |
| | 320 | 34621 |
| | 400 | 34622 |
| 500 | 34623 | |
| 600 | 34624 | |
| 800 | 34625 | |
| 1200 | 34627 | |

Silicon Carbide Heavy Duty Paper Discs C-E/C-F Discs

- Premium Silicon Carbide grain on a tough paper backing
- Designed for fine finishing and long life
- Available with hook and loop backing

CONCRETE Marble, granite, solid surface, ceramics, concrete, plastic

METAL Ferrous and non-ferrous metals

Contour Hand Pads on page 144



- Hook and loop fastening system allows for quick changes and less downtime
- Available with or without vacuum holes for use on random orbital or low speed DA sanders with capture systems
- Strong resin over resin bond construction is resistant to heat and moisture
- This special sharp and durable aluminum oxide grain cuts fast and lasts long

COATED ABRASIVES

PAPER DISCS



Disc Sander



Zirconium Z-X (Premium)

Premium Zirconium Grain

- Specially formulated X-weight Egyptian cotton cloth backing
- Closed coat structure

METAL Ferrous and/or non-ferrous metals (iron, steel, aluminum, copper, etc.)

STAINLESS Stainless steel, high tensile steel

Packaging

| | |
|---------------------|--------|
| 1" - 6" | 50/pkg |
| 7" - 12" | 25/pkg |
| 14" - 16", 18", 20" | 10/pkg |

See page 144 for backing pads

* 280 grit not available

| Size | Part No. TA-X | Grit Available | |
|--------|---------------|------------------|--|
| 1" | 34987 | 24 | |
| | 34988 | 36 | |
| | 34989 | 40 | |
| | 34990 | 50 | |
| | 34991 | 60 | |
| | 34992 | 80 | |
| | 34993 | 100-120-150-thru | |
| | 34999 | 180-220-240*-320 | |
| | 35000 | 24 | |
| 1-1/2" | 35001 | 36 | |
| | 35002 | 40 | |
| | 35003 | 50 | |
| | 35004 | 60 | |
| | 35005 | 80 | |
| | 35006 | 100-120-150-thru | |
| | 35013 | 180-220-240*-320 | |
| | 35020 | 24 | |
| | 35021 | 36 | |
| 2" | 35022 | 40 | |
| | 35023 | 50 | |
| | 35024 | 60 | |
| | 35025 | 80 | |
| | 35026 | 100-120-150-thru | |
| | 35033 | 180-220-240*-320 | |
| | 35040 | 24 | |
| | 35041 | 36 | |
| | 35042 | 40 | |
| 3" | 35043 | 50 | |
| | 35044 | 60 | |
| | 35045 | 80 | |
| | 35046 | 100-120-150-thru | |
| | 35053 | 180-220-240*-320 | |
| | 35060 | 24 | |
| | 35061 | 36 | |
| | 35062 | 40 | |
| | 35063 | 50 | |
| 4" | 35064 | 60 | |
| | 35065 | 80 | |
| | 35066 | 100-120-150-thru | |
| | 35073 | 180-220-240*-320 | |

| Size | Part No. | | Grit Available |
|-------|----------|-------|------------------|
| | TA-X | Z-X | |
| 5" | 35080 | - | 24 |
| | 35081 | - | 36 |
| | 35082 | 37082 | 40 |
| | 35083 | 37083 | 50 |
| | 35084 | 37084 | 60 |
| | 35085 | 37085 | 80 |
| | 35086 | - | 100-120-150-thru |
| | 35093 | - | 180-220-240*-320 |
| | 6" | 35094 | - |
| 35095 | | - | 36 |
| 35096 | | 37096 | 40 |
| 35097 | | 37097 | 50 |
| 35098 | | 37098 | 60 |
| 35099 | | 37099 | 80 |
| 35100 | | - | 100-120-150-thru |
| 35107 | | - | 180-220-240*-320 |
| 7" | | 35108 | - |
| | 35109 | - | 36 |
| | 35110 | - | 40 |
| | 35111 | - | 50 |
| | 35112 | - | 60 |
| | 35113 | - | 80 |
| | 35114 | - | 100-120-150-thru |
| | 35121 | - | 180-220-240*-320 |
| | 8" | 35122 | - |
| 35123 | | - | 36 |
| 35124 | | 37124 | 40 |
| 35125 | | 37125 | 50 |
| 35126 | | 37126 | 60 |
| 35127 | | 37127 | 80 |
| 35128 | | - | 100-120-150-thru |
| 35135 | | - | 180-220-240*-320 |

COATED ABRASIVES

CLOTH DISCS



- Strong resin over resin bond construction is resistant to heat and moisture
- Hot melt adhesive back allows for quick change and less downtime
- Label UPC bar coded for easy identification and inventory maintenance

CLOTH DISCS

PSA Discs



Aluminum Oxide TA-X

Aluminum Oxide Grain

- Strong X-weight Egyptian cotton cloth backing
- Closed coat structure

METAL Ferrous and/or non-ferrous metals (iron, steel, aluminum, copper, etc.)

WOOD Wood, plastic, fiberglass



See page 86 for packaging

* 280 grit not available

| Size | Part No. | | Grit Available |
|------|----------|-------|------------------|
| | TA-X | 2Z-X | |
| 9" | 35136 | - | 24 |
| | 35137 | - | 36 |
| | 35138 | 37138 | 40 |
| | 35139 | 37139 | 50 |
| | 35140 | 37140 | 60 |
| | 35141 | 37141 | 80 |
| | 35142 | - | 100-120-150-thru |
| 10" | 35149 | - | 180-220-240-*320 |
| | 35150 | - | 24 |
| | 35151 | - | 36 |
| | 35152 | 37152 | 40 |
| | 35153 | 37153 | 50 |
| | 35154 | 37154 | 60 |
| | 35155 | 37155 | 80 |
| 12" | 35156 | - | 100-120-150-thru |
| | 35163 | - | 180-220-240-*320 |
| | 35164 | - | 24 |
| | 35165 | - | 36 |
| | 35166 | 37166 | 40 |
| | 35167 | 37167 | 50 |
| | 35168 | 37168 | 60 |
| 14" | 35169 | 37169 | 80 |
| | 35170 | - | 100-120-150-thru |
| | 35177 | - | 180-220-240-*320 |
| | 35179 | - | 36 |
| | 35180 | - | 40 |
| | 35181 | - | 50 |
| | 35182 | - | 60 |
| 15" | 35183 | - | 80 |
| | 35184 | - | 100 |
| | 35185 | - | 120 |

| Size | Part No. | | Grit Available |
|------|----------|-------|----------------|
| | TA-X | 2Z-X | |
| 15" | 35193 | - | 36 |
| | 35194 | - | 40 |
| | 35195 | - | 50 |
| | 35196 | - | 60 |
| | 35197 | - | 80 |
| | 35198 | - | 100 |
| | 35199 | - | 120 |
| 16" | 35207 | - | 36 |
| | 35208 | - | 40 |
| | 35209 | - | 50 |
| | 35210 | - | 60 |
| | 35211 | - | 80 |
| | 35212 | - | 100 |
| | 35213 | - | 120 |
| 18" | 35221 | - | 36 |
| | 35222 | - | 40 |
| | 35223 | - | 50 |
| | 35224 | - | 60 |
| | 35225 | - | 80 |
| | 35226 | - | 100 |
| | 35227 | - | 120 |
| 20" | 35235 | - | 36 |
| | 35236 | 37236 | 40 |
| | 35237 | 37237 | 50 |
| | 35238 | 37238 | 60 |
| | 35239 | 37239 | 80 |
| | 35240 | - | 100 |
| | 35241 | - | 120 |

Tech INFO

- Strong resin over resin bond construction is resistant to heat and moisture
- Hot melt adhesive back allows for quick change and less downtime
- Label UPC bar coded for easy identification and inventory maintenance

COATED ABRASIVES

CLOTH DISCS

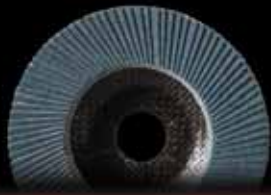

FLAP DISCS INTRODUCTION

Saves Time and Money

- Offers a combination of grinding and blending
- Combines the work of a depressed center wheel and resin fiber disc(s), eliminating the need for two separate operations

Variety

- Available in Fiberglass and Plastic Backing
- Available in Aluminum Oxide (2A), Zirconium (Z) and Aluminum Oxide with Coolants (3A)
- Available in Conical (type 29) and Flat (type 27)

Unparalleled Safety

- Made using the same stringent manufacturing constraints that we use on our bonded grinding wheels
- More fiberglass reinforcement than the majority of our competitor's product
- Fiberglass is the key determinant of product safety

Backing Type

Fiberglass backing features:

- Lighter, quieter operation
- Will not splinter or smear on the workpiece
- Backing will wear uniformly with abrasive cloth

Plastic backing features:

- Non-scratching, high strength backing
- Resistant to temperature extremes, common chemicals and solvents

Backing Shape

Conical shape features (type 29):

- Built-in angle for increased contact area
- Best for use on large, flat surfaces or complex work shapes
- Minimizes workpiece gouging
- More aggressive stock removal due to higher angle

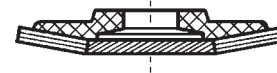

Flat shape features (type 27):

- Best for use on miter joints, corners and edges
- Best choice for finishing intricate and ornate surfaces
- More forgiving than conical shape

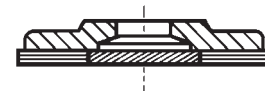

| Product | Product Type | Backing | Product Shape | Specs. | Page No. |
|--|------------------|------------|-------------------|-----------|----------|
| OVATION [®] | High Density | Fiberglass | Flat (Type 27) | Z | 90-91 |
| OVATION [®] ATTACKER [®] | High Density | Fiberglass | Flat (Type 27) | Z | 90-91 |
| SAITLAM [™] | High Performance | Plastic | Flat (Type 27) | 2A, 3A, Z | 94 |
| SAITLAM K [™] | High Performance | Plastic | Conical (Type 29) | 2A, Z | 94 |
| SAITLAM F [™] | High Performance | Fiberglass | Conical (Type 29) | 2A, 3A, Z | 93 |
| SAITLAM UP [™] | General Purpose | Fiberglass | Flat (Type 27) | Z | 92 |
| SAITLAM UK [™] | General Purpose | Fiberglass | Conical (Type 29) | Z | 92 |
| SAITLAM PN [™] | General Purpose | Plastic | Flat (Type 27) | Z | 92 |

FLAP DISCS INTRODUCTION

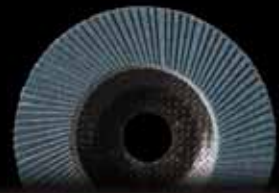

NEW!



COATED
ABRASIVES

SAITLAM™ Material Availability

- 3 materials available to suit the majority of industrial applications
- All materials are resin over resin bond for a strong bond resistant to heat and moisture

3A

- Premium aluminum oxide grain with grinding aid
- Specially formulated to reduce heat build-up on workpiece
- Reduces loading on Aluminum and other non-ferrous applications
- Excellent choice for Stainless Steel and other heat sensitive materials

STAINLESS Stainless steel, high tensile steel, titanium

METAL Ferrous and/or non-ferrous metals

2A

- Premium aluminum oxide grain
- General purpose, long life
- Closed coat structure for more material removal

METAL Ferrous and/or non-ferrous metals (iron, steel, aluminum, brass, copper etc.)

Z

- Premium zirconium grain
- Extremely long life
- Closed coat structure for more material removal
- Fast, aggressive cutting action for high pressure grinding
- An industry standard for flap discs

STAINLESS Stainless steel, high tensile alloys

METAL Ferrous and/or non-ferrous metals

High Performance



FLAP DISCS
OVATION®

The Original
SAIT
OVATION®

NEW! **OVATION®**
ATTACKER®



**MORE GRINDING MATERIAL =
INCREASED PRODUCTIVITY
& LONG LIFE**



KEY FEATURES

- Heavy duty for tougher applications
- High pressure is ideal for removing deeper scratches from the work surface
- Made with premium zirconium abrasive material which provides long-life and high stock removal

- METAL** Ferrous and/or non-ferrous metals
- STAINLESS** Stainless steel, high tensile steel, titanium

KEY FEATURES

- Conformability – a softer cushioned design that is ideal on irregular surfaces
- Flap design allows the use of light pressure to produce the perfect finish
- Specially designed abrasive flaps provide aggressive cutting action

- STAINLESS** Stainless steel, high tensile steel, titanium, aluminum
- METAL** Ferrous metals and non-ferrous metals

HIGH DENSITY

COATED ABRASIVES

FLAP DISCS

**Heavy Duty
Long Life**



**Will Not Contaminate
Stainless Steel**

**Conformability
Fast Cutting**



**Will Not Contaminate
Stainless Steel**

FLAP DISCS

OVATION®

High Performance



Ovation® Design

Flap Disc Configuration

A high density design that contains more flaps that are larger to provide long-life

Control

Provides excellent operator control resulting in a consistent finish with controlled stock removal rates

Ovation® Safety

Fiberglass Backing

Specially engineered fiberglass backing designed for strength and safety

Adhesive System

Specially formulated adhesive system designed for safety and to effectively secure the abrasive flaps to the backing



HIGH DENSITY

| Mat'l | Size | | Grit | Part No. Ovation® |
|-------------------------------|--------|--------|-------|-------------------|
| | Dia. | Arbor | | |
| Z Premium Zirconium | 4-1/2 | 7/8 | 36 | 78005 |
| | 4-1/2 | 7/8 | 40 | 78006 |
| | 4-1/2 | 7/8 | 60 | 78008 |
| | 4-1/2 | 7/8 | 80 | 78009 |
| | 4-1/2 | 7/8 | 120 | 78011 |
| | 4-1/2 | 5/8-11 | 36 | 78105 |
| | 4-1/2 | 5/8-11 | 40 | 78106 |
| | 4-1/2 | 5/8-11 | 60 | 78108 |
| | 4-1/2 | 5/8-11 | 80 | 78109 |
| | 4-1/2 | 5/8-11 | 120 | 78111 |
| | 5 | 7/8 | 36 | 78025 |
| | 5 | 7/8 | 40 | 78026 |
| | 5 | 7/8 | 60 | 78028 |
| | 5 | 7/8 | 80 | 78029 |
| | 5 | 7/8 | 120 | 78031 |
| | 5 | 5/8-11 | 36 | 78125 |
| | 5 | 5/8-11 | 40 | 78126 |
| | 5 | 5/8-11 | 60 | 78128 |
| | 5 | 5/8-11 | 80 | 78129 |
| | 5 | 5/8-11 | 120 | 78131 |
| | 6 | 7/8 | 36 | 78035 |
| | 6 | 7/8 | 40 | 78036 |
| | 6 | 7/8 | 60 | 78038 |
| | 6 | 7/8 | 80 | 78039 |
| | 6 | 7/8 | 120 | 78041 |
| | 6 | 5/8-11 | 36 | 78135 |
| | 6 | 5/8-11 | 40 | 78136 |
| | 6 | 5/8-11 | 60 | 78138 |
| | 6 | 5/8-11 | 80 | 78139 |
| | 6 | 5/8-11 | 120 | 78141 |
| 7 | 7/8 | 36 | 78045 | |
| 7 | 7/8 | 40 | 78046 | |
| 7 | 7/8 | 60 | 78048 | |
| 7 | 7/8 | 80 | 78049 | |
| 7 | 7/8 | 120 | 78051 | |
| 7 | 5/8-11 | 36 | 78145 | |
| 7 | 5/8-11 | 40 | 78146 | |
| 7 | 5/8-11 | 60 | 78148 | |
| 7 | 5/8-11 | 80 | 78149 | |
| 7 | 5/8-11 | 120 | 78151 | |

NEW! OVATION® ATTACKER®

| Mat'l | Size | | Grit | Part No Ovation® Attacker® |
|-------------------------------|--------|--------|-------|----------------------------|
| | Dia. | Arbor | | |
| Z Premium Zirconium | 4-1/2 | 7/8 | 40 | 76206 |
| | 4-1/2 | 7/8 | 60 | 76208 |
| | 4-1/2 | 7/8 | 80 | 76209 |
| | 4-1/2 | 7/8 | 120 | 76211 |
| | 4-1/2 | 5/8-11 | 40 | 76316 |
| | 4-1/2 | 5/8-11 | 60 | 76318 |
| | 4-1/2 | 5/8-11 | 80 | 76319 |
| | 4-1/2 | 5/8-11 | 120 | 76321 |
| | 5 | 7/8 | 40 | 76226 |
| | 5 | 7/8 | 60 | 76228 |
| | 5 | 7/8 | 80 | 76229 |
| | 5 | 7/8 | 120 | 76231 |
| | 5 | 5/8-11 | 40 | 76336 |
| | 5 | 5/8-11 | 60 | 76338 |
| | 5 | 5/8-11 | 80 | 76339 |
| | 5 | 5/8-11 | 120 | 76341 |
| | 6 | 7/8 | 40 | 76236 |
| | 6 | 7/8 | 60 | 76238 |
| | 6 | 7/8 | 80 | 76239 |
| | 6 | 7/8 | 120 | 76241 |
| | 6 | 5/8-11 | 40 | 76346 |
| | 6 | 5/8-11 | 60 | 76348 |
| | 6 | 5/8-11 | 80 | 76349 |
| | 6 | 5/8-11 | 120 | 76351 |
| | 7 | 7/8 | 40 | 76246 |
| | 7 | 7/8 | 60 | 76248 |
| | 7 | 7/8 | 80 | 76249 |
| | 7 | 7/8 | 120 | 76251 |
| | 7 | 5/8-11 | 40 | 76356 |
| | 7 | 5/8-11 | 60 | 76358 |
| 7 | 5/8-11 | 80 | 76359 | |
| 7 | 5/8-11 | 120 | 76361 | |

COATED ABRASIVES

FLAP DISCS

APPLICATIONS | Weld grinding and blending • Edge breaking
• Deburring • Finishing and blending • Contour finishing

General Purpose-Zirconium **FLAP DISCS**



Angle Grinder

Fiberglass Backing

- Allows for lighter, quieter operation
- Will not splinter or smear on the workpiece
- Backing wears with the abrasives cloth

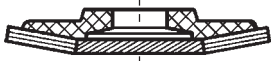

Saitlam UK™ (conical shape - type 29)

- Conical shape ideal for working with large surfaces or complex shapes
- Working angle is "built-in"
- For general purpose stock removal and finishing

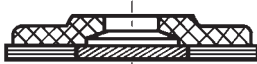

Saitlam UP™ (flat shape - type 27)

- Flat shape ideal for use on miter joints, corners and edges
- Provides an even "finish ready" surface
- For general purpose stock removal and finishing



Plastic Backing

- A non-scratching, high strength backing resistant to temperature extremes, common chemicals and solvents



Saitlam PN™ (flat shape - type 27)

- Flat shape ideal for use on miter joints, corners and edges
- Provides an even "finish ready" surface
- For general purpose stock removal and finishing

| Mat'l | Size | | | Part Nos. | | |
|----------------|-------|-------|------|-------------|-------------|-------------|
| | Dia. | Arbor | Grit | Saitlam UK™ | Saitlam UP™ | Saitlam PN™ |
| Z Zirconium | 4-1/2 | 7/8 | 40 | 73685 | 73890 | 73502 |
| | 4-1/2 | 7/8 | 50 | 73686 | 73891 | 73503 |
| | 4-1/2 | 7/8 | 60 | 73687 | 73892 | 73504 |
| | 4-1/2 | 7/8 | 80 | 73688 | 73893 | 73505 |
| | 4-1/2 | 7/8 | 120 | 73689 | 73894 | 73506 |
| | 5 | 7/8 | 40 | 73694 | 73895 | - |
| | 5 | 7/8 | 50 | 73695 | 73896 | - |
| | 5 | 7/8 | 60 | 73696 | 73897 | - |
| | 5 | 7/8 | 80 | 73697 | 73898 | - |
| | 5 | 7/8 | 120 | 73698 | 73899 | - |
| | 7 | 7/8 | 40 | 73714 | - | - |
| | 7 | 7/8 | 50 | 73715 | - | - |
| | 7 | 7/8 | 60 | 73716 | - | - |
| | 7 | 7/8 | 80 | 73717 | - | - |
| | 7 | 7/8 | 120 | 73718 | - | - |

Packaging
10/box

COATED
ABRASIVES

FLAP DISCS

FLAP DISCS

High Performance

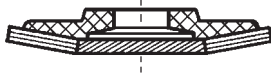

Saitlam F™ (conical shape - type 29, fiberglass backing)

- Available in 2A, 3A aluminum oxide with grinding aid and Z zirconium
- Fiberglass backing for lighter, more silent operation
- Fiberglass backing will not splinter or smear on the workpiece
- Backing wears with the abrasive cloth
- Go from stock removal to finishing with one disc



| Mat'l | Size | | Grit | Part No. Saitlam F™ |
|--|--------|--------|-------|---------------------|
| | Dia. | Arbor | | |
| 2A General purpose aluminum oxide | 4-1/2 | 7/8 | 40 | 75440 |
| | 4-1/2 | 7/8 | 50 | 75450 |
| | 4-1/2 | 7/8 | 60 | 75460 |
| | 4-1/2 | 7/8 | 80 | 75480 |
| | 4-1/2 | 7/8 | 120 | 75420 |
| | 4-1/2 | 5/8-11 | 40 | 76440 |
| | 4-1/2 | 5/8-11 | 50 | 76450 |
| | 4-1/2 | 5/8-11 | 60 | 76460 |
| | 4-1/2 | 5/8-11 | 80 | 76480 |
| | 4-1/2 | 5/8-11 | 120 | 76420 |
| | 5 | 7/8 | 40 | 75540 |
| | 5 | 7/8 | 50 | 75550 |
| | 5 | 7/8 | 60 | 75560 |
| | 5 | 7/8 | 80 | 75580 |
| | 5 | 7/8 | 120 | 75520 |
| | 5 | 5/8-11 | 40 | 76540 |
| | 5 | 5/8-11 | 50 | 76550 |
| | 5 | 5/8-11 | 60 | 76560 |
| | 5 | 5/8-11 | 80 | 76580 |
| | 5 | 5/8-11 | 120 | 76520 |
| | 7 | 7/8 | 40 | 75740 |
| | 7 | 7/8 | 50 | 75750 |
| | 7 | 7/8 | 60 | 75760 |
| | 7 | 7/8 | 80 | 75780 |
| | 7 | 7/8 | 120 | 75720 |
| | 7 | 5/8-11 | 40 | 76740 |
| | 7 | 5/8-11 | 50 | 76750 |
| | 7 | 5/8-11 | 60 | 76760 |
| 7 | 5/8-11 | 80 | 76780 | |
| 7 | 5/8-11 | 120 | 76720 | |
| 3A Aluminum Oxide with grinding aid | 4-1/2 | 7/8 | 40 | 73341 |
| | 4-1/2 | 7/8 | 60 | 73361 |
| | 4-1/2 | 7/8 | 80 | 73381 |
| | 4-1/2 | 7/8 | 120 | 73321 |
| | 4-1/2 | 5/8-11 | 40 | 74341 |
| | 4-1/2 | 5/8-11 | 60 | 74361 |
| | 4-1/2 | 5/8-11 | 80 | 74381 |
| | 4-1/2 | 5/8-11 | 120 | 74321 |
| | 5 | 7/8 | 40 | 73804 |
| | 5 | 7/8 | 60 | 73806 |
| | 5 | 7/8 | 80 | 73808 |
| | 5 | 7/8 | 120 | 73802 |
| | 5 | 5/8-11 | 40 | 74804 |
| | 5 | 5/8-11 | 60 | 74806 |
| | 5 | 5/8-11 | 80 | 74808 |
| | 5 | 5/8-11 | 120 | 74802 |
| | 7 | 7/8 | 40 | 73704 |
| | 7 | 7/8 | 50 | 73705 |
| | 7 | 7/8 | 60 | 73706 |
| | 7 | 7/8 | 80 | 73708 |
| | 7 | 7/8 | 120 | 73702 |
| | 7 | 5/8-11 | 40 | 74704 |
| | 7 | 5/8-11 | 50 | 74705 |
| | 7 | 5/8-11 | 60 | 74706 |
| | 7 | 5/8-11 | 80 | 74708 |
| | 7 | 5/8-11 | 120 | 74702 |

| RPM's | |
|--------|--------|
| 4-1/2" | 13,300 |
| 5" | 12,200 |
| 7" | 8,500 |

Packaging
10/box

| Mat'l | Size | | Grit | Part No. Saitlam F™ |
|------------------------|--------|--------|-------|---------------------|
| | Dia. | Arbor | | |
| Z Premium Zirconium | 4-1/2 | 7/8 | 40 | 73940 |
| | 4-1/2 | 7/8 | 50 | 73950 |
| | 4-1/2 | 7/8 | 60 | 73960 |
| | 4-1/2 | 7/8 | 80 | 73980 |
| | 4-1/2 | 7/8 | 120 | 73920 |
| | 4-1/2 | 5/8-11 | 40 | 74940 |
| | 4-1/2 | 5/8-11 | 50 | 74950 |
| | 4-1/2 | 5/8-11 | 60 | 74960 |
| | 4-1/2 | 5/8-11 | 80 | 74980 |
| | 4-1/2 | 5/8-11 | 120 | 74920 |
| | 5 | 7/8 | 40 | 73941 |
| | 5 | 7/8 | 50 | 73951 |
| | 5 | 7/8 | 60 | 73961 |
| | 5 | 7/8 | 80 | 73981 |
| | 5 | 7/8 | 120 | 73921 |
| | 5 | 5/8-11 | 40 | 74941 |
| | 5 | 5/8-11 | 50 | 74951 |
| | 5 | 5/8-11 | 60 | 74961 |
| | 5 | 5/8-11 | 80 | 74981 |
| | 5 | 5/8-11 | 120 | 74921 |
| | 7 | 7/8 | 40 | 73942 |
| | 7 | 7/8 | 50 | 73952 |
| | 7 | 7/8 | 60 | 73962 |
| | 7 | 7/8 | 80 | 73982 |
| | 7 | 7/8 | 120 | 73922 |
| | 7 | 5/8-11 | 40 | 74942 |
| | 7 | 5/8-11 | 50 | 74952 |
| | 7 | 5/8-11 | 60 | 74962 |
| 7 | 5/8-11 | 80 | 74982 | |
| 7 | 5/8-11 | 120 | 74922 | |

COATED ABRASIVES

FLAP DISCS

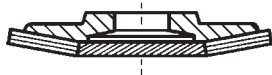
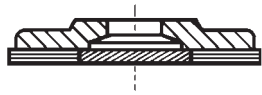

Saitlam™ (flat shape - type 27)

- Available in 2A aluminum oxide, 3A aluminum oxide with grinding aid, and Z zirconium
- **Nylon 6/6 backing** - a non-scratching, high strength backing resistant to temperature extremes, common chemicals, and solvents
- Provides an even "finish ready" surface
- Excellent for miter joints, corners, and edges

Saitlam K™ (conical shape - type 29)

- Available in 2A aluminum oxide and Z zirconium
- Nylon 6/6 backing - a non-scratching, high strength backing resistant to temperature extremes, common chemicals, and solvents
- **Conical shape ideal when working with large surfaces or complex work shapes**
- Working angle is "built in"

PROPER MOUNTING

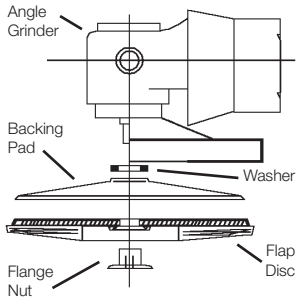

Saitlam™

| Mat'l | Size | | Grit | Part No. |
|--|-------|-------|-------|----------|
| | Dia. | Arbor | | |
| 2A General purpose aluminum oxide | 4 | 5/8 | 40 | 73240 |
| | 4 | 5/8 | 60 | 73260 |
| | 4 | 5/8 | 80 | 73280 |
| | 4 | 5/8 | 120 | 73220 |
| | 4-1/2 | 7/8 | 40 | 73440 |
| | 4-1/2 | 7/8 | 60 | 73460 |
| | 4-1/2 | 7/8 | 80 | 73480 |
| | 4-1/2 | 7/8 | 120 | 73420 |
| | 6-1/2 | 7/8 | 36 | 73636 |
| | 6-1/2 | 7/8 | 50 | 73650 |
| | 6-1/2 | 7/8 | 60 | 73660 |
| | 6-1/2 | 7/8 | 80 | 73680 |
| 6-1/2 | 7/8 | 120 | 73620 | |
| 3A Aluminum Oxide with grinding aid | 4 | 5/8 | 40 | 73040 |
| | 4 | 5/8 | 60 | 73060 |
| | 4 | 5/8 | 80 | 73080 |
| | 4 | 5/8 | 120 | 73020 |
| | 4-1/2 | 7/8 | 40 | 73340 |
| | 4-1/2 | 7/8 | 60 | 73360 |
| | 4-1/2 | 7/8 | 80 | 73380 |
| | 4-1/2 | 7/8 | 120 | 73320 |
| | 6-1/2 | 7/8 | 36 | 73836 |
| | 6-1/2 | 7/8 | 50 | 73850 |
| | 6-1/2 | 7/8 | 60 | 73860 |
| | 6-1/2 | 7/8 | 80 | 73880 |
| 6-1/2 | 7/8 | 120 | 73820 | |
| Z Premium Zirconium | 4 | 5/8 | 40 | 73140 |
| | 4 | 5/8 | 50 | 73150 |
| | 4 | 5/8 | 60 | 73160 |
| | 4 | 5/8 | 80 | 73180 |
| | 4-1/2 | 7/8 | 40 | 73540 |
| | 4-1/2 | 7/8 | 50 | 73550 |
| | 4-1/2 | 7/8 | 60 | 73560 |
| | 4-1/2 | 7/8 | 80 | 73580 |
| | 6-1/2 | 7/8 | 36 | 73736 |
| | 6-1/2 | 7/8 | 50 | 73750 |
| | 6-1/2 | 7/8 | 60 | 73760 |
| | 6-1/2 | 7/8 | 80 | 73780 |

Packaging

| | |
|--------|---------------------------------|
| 4" | 10/box with nut |
| 4-1/2" | 10/box with nut |
| 6-1/2" | 10/box with nut and backing pad |

RPM's for Saitlam™ / Saitlam K™

| | |
|--------|--------|
| 4" | 13,000 |
| 4-1/2" | 11,000 |
| 6-1/2" | 8,600 |

NOTE: • 4" and 4-1/2" Saitlam™ and Saitlam K™ must be used with nut
• 6-1/2" must be used with backing pad and nut

See page 146 for additional pads and nuts



Saitlam K™

| Mat'l | Size | | Grit | Part No. |
|--|-------|-------|------|----------|
| | Dia. | Arbor | | |
| 2A General purpose alum oxide | 4-1/2 | 7/8 | 40 | 73490 |
| | 4-1/2 | 7/8 | 60 | 73491 |
| | 4-1/2 | 7/8 | 80 | 73492 |
| | 4-1/2 | 7/8 | 120 | 73493 |
| Z Premium Zirconium | 4-1/2 | 7/8 | 40 | 73590 |
| | 4-1/2 | 7/8 | 50 | 73591 |
| | 4-1/2 | 7/8 | 60 | 73592 |
| | 4-1/2 | 7/8 | 80 | 73593 |

COATED
ABRASIVES

FLAP DISCS

FLAP WHEELS

Small Diameter



| Mat'l | Size | | Grit | Part Number | |
|--|-------|-------|-------|-------------|-----------------|
| | Dia. | Width | | 1/4 | 1/4-20 Threaded |
| 2A General purpose aluminum oxide | 1 | 3/4 | 60 | 70001 | 71000 |
| | 1 | 3/4 | 80 | 70002 | 71001 |
| | 1 | 3/4 | 120 | 70003 | 71002 |
| | 1 | 3/4 | 180 | 70004 | 71003 |
| | 1 | 3/4 | 240 | 70005 | 71004 |
| | 1 | 1 | 60 | 70010 | 71010 |
| | 1 | 1 | 80 | 70011 | 71011 |
| | 1 | 1 | 120 | 70012 | 71012 |
| | 1 | 1 | 180 | 70013 | 71013 |
| | 1 | 1 | 240 | 70014 | 71014 |
| | 1-1/2 | 1/2 | 40 | 70024 | - |
| | 1-1/2 | 1/2 | 60 | 70025 | 71020 |
| | 1-1/2 | 1/2 | 80 | 70026 | 71021 |
| | 1-1/2 | 1/2 | 120 | 70027 | 71022 |
| | 1-1/2 | 1/2 | 180 | 70028 | 71023 |
| | 1-1/2 | 1/2 | 240 | 70029 | 71024 |
| | 1-1/2 | 1 | 60 | 70040 | 71030 |
| | 1-1/2 | 1 | 80 | 70041 | 71031 |
| | 1-1/2 | 1 | 120 | 70042 | 71032 |
| | 1-1/2 | 1 | 180 | 70043 | 71033 |
| | 1-1/2 | 1 | 240 | 70044 | 71034 |
| | 2 | 1 | 40 | 70049 | - |
| | 2 | 1 | 60 | 70050 | 71040 |
| | 2 | 1 | 80 | 70051 | 71041 |
| | 2 | 1 | 120 | 70052 | 71042 |
| | 2 | 1 | 180 | 70053 | 71043 |
| | 2 | 1 | 240 | 70054 | 71044 |
| | 2-1/2 | 1/2 | 60 | 70060 | 71050 |
| | 2-1/2 | 1/2 | 80 | 70061 | 71051 |
| | 2-1/2 | 1/2 | 120 | 70062 | 71052 |
| | 2-1/2 | 1/2 | 180 | 70063 | 71053 |
| | 2-1/2 | 1/2 | 240 | 70064 | 71054 |
| | 2-1/2 | 1 | 40 | 70069 | - |
| | 2-1/2 | 1 | 60 | 70070 | 71055 |
| | 2-1/2 | 1 | 80 | 70071 | 71056 |
| | 2-1/2 | 1 | 120 | 70072 | 71057 |
| | 2-1/2 | 1 | 180 | 70073 | 71058 |
| | 2-1/2 | 1 | 240 | 70074 | 71059 |
| | 3 | 1/2 | 60 | 70080 | 71060 |
| | 3 | 1/2 | 80 | 70081 | 71061 |
| | 3 | 1/2 | 120 | 70082 | 71062 |
| | 3 | 1/2 | 180 | 70083 | 71063 |
| | 3 | 1/2 | 240 | 70084 | 71064 |
| | 3 | 3/4 | 60 | 70090 | 71070 |
| | 3 | 3/4 | 80 | 70091 | 71071 |
| 3 | 3/4 | 120 | 70092 | 71072 | |
| 3 | 3/4 | 180 | 70093 | 71073 | |
| 3 | 3/4 | 240 | 70094 | 71074 | |
| 3 | 1 | 40 | 70099 | - | |
| 3 | 1 | 60 | 70100 | 71080 | |
| 3 | 1 | 80 | 70101 | 71081 | |
| 3 | 1 | 120 | 70102 | 71082 | |
| 3 | 1 | 180 | 70103 | 71083 | |
| 3 | 1 | 240 | 70104 | 71084 | |
| 3 | 2 | 40 | 70110 | - | |
| 3 | 2 | 60 | 70111 | - | |
| 3 | 2 | 80 | 70112 | - | |
| 3 | 2 | 120 | 70113 | - | |
| 3A Aluminum Oxide with grinding aid | 2 | 1 | 60 | 74050 | 71160 |
| | 2 | 1 | 80 | 74051 | 71161 |
| | 2 | 1 | 120 | 74052 | 71162 |
| | 2-1/2 | 1 | 60 | 74060 | 71170 |
| | 2-1/2 | 1 | 80 | 74061 | 71171 |
| | 2-1/2 | 1 | 120 | 74062 | 71172 |
| | 3 | 1 | 60 | 74070 | 71180 |
| | 3 | 1 | 80 | 74071 | 71181 |
| 3 | 1 | 120 | 74072 | 71182 | |

Aluminum Oxide 2A

- Premium aluminum oxide grain
- **General purpose**
- Excellent for cleaning, deburring, polishing, blending

METAL Ferrous and/or non-ferrous metals (iron, steel, aluminum, copper, etc.)

WOOD Wood, plastic, fiberglass, etc.

Aluminum Oxide with Grinding Aid 3A

- Premium aluminum oxide grain with grinding aid
- **Excellent for reducing heat build-up on heat sensitive materials**
- Excellent for cleaning, deburring, polishing, blending

STAINLESS Stainless steel, high tensile steel, titanium

METAL Ferrous and/or non-ferrous metals

Straight 1/4" and threaded 1/4-20 mandrels available
See page 146 for 1/4-20 adapter

Packaging
10/box



COATED ABRASIVES

FLAP WHEELS



- Resin over resin construction for a strong bond resistant to heat and moisture
- Closed coat structure for more material removal
- High quality Egyptian cotton cloth backing provides superior durability
- Label UPC bar coded for easy identification and inventory maintenance



Aluminum Oxide 2A

- Premium aluminum oxide grain
- General purpose
- Excellent for cleaning, deburring, polishing, blending

METAL Ferrous and/or non-ferrous metals (iron, steel, aluminum, copper, etc.)

WOOD Wood, plastic, fiberglass, etc.

Aluminum Oxide 3A with Grinding Aid

- Premium aluminum oxide grain with grinding aid
- Excellent for reducing heat build-up on heat sensitive materials
- Excellent for cleaning, deburring, polishing, blending

STAINLESS Stainless steel, high tensile steel, titanium

METAL Ferrous and non-ferrous metals

COATED ABRASIVES

FLAP WHEELS

| Mat'l | Size | | | Max RPM | Grits Available | Part No. |
|--|------|-------|---------|---------|-----------------|----------|
| | Dia. | Width | Spindle | | | |
| 2A Premium aluminum oxide | 6 | 1 | 1 | 6,000 | 60 | 72000 |
| | 6 | 1 | 1 | 6,000 | 80 | 72001 |
| | 6 | 1 | 1 | 6,000 | 100 | 72002 |
| | 6 | 1 | 1 | 6,000 | 120 | 72003 |
| | 6 | 1-1/2 | 1 | 6,000 | 60 | 72020 |
| | 6 | 1-1/2 | 1 | 6,000 | 80 | 72021 |
| | 6 | 1-1/2 | 1 | 6,000 | 100 | 72022 |
| | 6 | 1-1/2 | 1 | 6,000 | 120 | 72023 |
| | 6 | 2 | 1 | 6,000 | 60 | 72030 |
| | 6 | 2 | 1 | 6,000 | 80 | 72031 |
| | 6 | 2 | 1 | 6,000 | 100 | 72032 |
| | 6 | 2 | 1 | 6,000 | 120 | 72033 |
| | 8 | 1 | 1 | 4,400 | 60 | 72040 |
| | 8 | 1 | 1 | 4,400 | 80 | 72041 |
| | 8 | 1 | 1 | 4,400 | 100 | 72042 |
| | 8 | 1 | 1 | 4,400 | 120 | 72043 |
| | 8 | 2 | 1 | 4,400 | 60 | 72050 |
| | 8 | 2 | 1 | 4,400 | 80 | 72051 |
| | 8 | 2 | 1 | 4,400 | 100 | 72052 |
| | 8 | 2 | 1 | 4,400 | 120 | 72053 |
| 3A Premium aluminum oxide with grinding aid | 6 | 1 | 1 | 6,000 | 60 | 72005 |
| | 6 | 1 | 1 | 6,000 | 80 | 72006 |
| | 6 | 1 | 1 | 6,000 | 100 | 72007 |
| | 6 | 1 | 1 | 6,000 | 120 | 72008 |
| | 6 | 1-1/2 | 1 | 6,000 | 60 | 72025 |
| | 6 | 1-1/2 | 1 | 6,000 | 80 | 72026 |
| | 6 | 1-1/2 | 1 | 6,000 | 100 | 72027 |
| | 6 | 1-1/2 | 1 | 6,000 | 120 | 72028 |
| | 6 | 2 | 1 | 6,000 | 60 | 72035 |
| | 6 | 2 | 1 | 6,000 | 80 | 72036 |
| 6 | 2 | 1 | 6,000 | 100 | 72037 | |
| 6 | 2 | 1 | 6,000 | 120 | 72038 | |

QT Quick Tip
Slower speeds = better flap wheel performance and life.

See page 146 for:
1"-5/8" bushing - #95109
1/4" shank adapter kit - #95009

Packaging
6" 5/box
8" 3/box



- Resin over resin construction for a strong bond resistant to heat and moisture
- Closed coat structure for more material removal
- High quality Egyptian cotton cloth backing provides superior durability
- Label UPC bar coded for easy identification and inventory maintenance

SHEETS INTRODUCTION



United Abrasives provides a full product offering of cloth and paper sheets. With availability in a variety of sizes and materials, chances are we have the abrasive sheet to fit your needs. Whether you are working by hand or with mechanical assistance, these products are sure to exceed your expectations.

Ultimate Performance Paper Sheets:

Our highest quality industrial paper. Available in aluminum oxide (AW-C and AW-D), premium stearate aluminum oxide (4S), stearate aluminum oxide (3S), silicon carbide (CW-C) and garnet. See pages 98-99 for more information.

Premium Cloth 9 X 11 sheets:

Our highest quality cloth sheet. Made from SAIT DA-F material, these sheets are very flexible while maintaining the highest durability. Open coat design. See page 98 for more details.

Saitscreen™ 9 X 11 sheets:

Cloth screen impregnated with silicon carbide grain. Non-loading, wet/dry design. See page 102 for complete product offering.

Fileboard sheets:

For use on straight line machine and hand held files with clip-on design and PSA design. Available in clip on design (2-3/4" x 17-1/2") with our 4S premium aluminum oxide and stearate silicon carbide grain. Also available in PSA (2-3/4" x 16-1/2") and PSA Roll with our 4S premium aluminum oxide stearate material.

Zirconium (Z-F) material is available in PSA and hook & loop (2-3/4" x 16-1/2") and clip on design. See pages 101 for details.

Dry Wall Sheets:

Premium products to fit plaster and dry wall joint applications. Available in Saitscreen™ cloth screen and silicon carbide paper sheets and rolls. See page 102 for more information.

Sponges:

Premium quality sanding sponges for top performance. Available in 1" sanding blocks, 1/2" fabric reinforced, and 5mm contour pads. See page 103 for more information.



Hand Sanding



Cloth Sheets

Aluminum Oxide (DA-F)

- Aluminum oxide grain on a flexible cloth backing
- Open coat structure prevents loading
- Water resistant
- Long life combined with excellent stock removal
- Excellent for woodworking applications

WOOD Wood, plastic, fiberglass

METAL Ferrous and/or non-ferrous materials (iron, steel, copper, etc.)

- Available in F-weight - high flexibility

| Size | Grit | Part No. | Std Pkg. |
|----------------|------|----------|----------|
| 9 x 11 DA-F | 36 | 84907 | 25 |
| | 40 | 84908 | 25 |
| | 50 | 84909 | 25 |
| | 60 | 84910 | 25 |
| | 80 | 84911 | 25 |
| | 100 | 84912 | 50 |
| | 120 | 84913 | 50 |
| | 150 | 84914 | 50 |
| | 180 | 84915 | 50 |
| | 220 | 84916 | 50 |
| | 240 | 84917 | 50 |
| | 320 | 84918 | 50 |

Aluminum Oxide



Paper Sheets

Aluminum Oxide (AW-C & AW-D)

- Extremely long lasting
- Open coat structure prevents loading
- Use wet or dry

WOOD Wood, sealers, fillers

METAL Ferrous and/or non-ferrous metals

- Available in grits up to 1200 for ultra fine finishing
- Available in weights: "C"-medium weight, medium flexibility
"D"-heavy weight, low flexibility

Garnet

- Natural garnet grain
- Open coat structure prevents loading
- Use dry only

WOOD Soft woods

- Available in weights: "A"-light weight, high flexibility
"C"-medium weight, medium flexibility
"D"-heavy weight, low flexibility

| | Size | Grit Wgt. | Part No. | Std Pkg. |
|----------------|----------------|-----------|----------|----------|
| Aluminum Oxide | 9 x 11 AW-D | 40D | 84211 | 100 |
| | | 50D | 84212 | 100 |
| | | 60D | 84213 | 100 |
| | | 80D | 84214 | 100 |
| | | 100D | 84215 | 100 |
| | | 120D | 84216 | 100 |
| Aluminum Oxide | 9 x 11 AW-C | 150C | 84200 | 100 |
| | | 180C | 84201 | 100 |
| | | 220C | 84202 | 100 |
| | | 240C | 84203 | 100 |
| | | 320C | 84204 | 100 |
| | | 400C | 84205 | 100 |
| | | 500C | 84206 | 100 |
| | | 600C | 84207 | 100 |
| | | 800C | 84208 | 100 |
| | | 1200C | 84209 | 100 |
| Garnet | 9 x 11 | 50D | 84101 | 50 |
| | | 60D | 84102 | 50 |
| | | 80D | 84103 | 50 |
| | | 100C | 84104 | 100 |
| | | 120C | 84105 | 100 |
| | | 180A | 84107 | 100 |
| | | 220A | 84108 | 100 |



- Resin over resin construction for a strong bond resistant to heat and moisture
- Cloth backing for durability and flexibility
- Box label UPC bar coded for easy identification and inventory maintenance
- Our highest quality industrial paper for extra durability on all applications
- Broad assortment of grit sizes for a wide range of sanding and finishing applications
- Strong resin over resin bond construction is resistant to heat and moisture

COATED
ABRASIVES

SHEETS



Premium Stearate Aluminum Oxide (4S)

- Premium aluminum oxide
- Stearate coating and open coat structure lubricates and prevents loading
- Long lasting performance and fast removal rates for fine finishing of automotive body works and wood finishing
- Use dry only
- Available in C-weight - medium weight, low flexibility

WOOD Body filler, paint, fiberglass, wood and fiberglass

METAL Ferrous and non-ferrous metals

Stearate Aluminum Oxide (3S)

- Extremely long lasting
- Open coat structure prevents loading
- Use dry only

WOOD Sealers, body filler, paint, fiberglass, wood

METAL Aluminum

- Available in grits up to 500 for fine finishing
- Available in C-weight - medium weight, medium flexibility



COATED ABRASIVES

SHEETS

| | Size | Grit Wgt. | Part No. | | Std Pkg. |
|-------------------------|--------|-----------|----------|-------|----------|
| | | | 3S | 4S | |
| Stearate Aluminum Oxide | 9 x 11 | 80C | 84230 | 84283 | 100 |
| | | 100C | 84231 | 84284 | 100 |
| | | 120C | 84232 | 84285 | 100 |
| | | 150C | 84233 | 84286 | 100 |
| | | 180C | 84234 | 84287 | 100 |
| | | 220C | 84235 | 84288 | 100 |
| | | 240C | 84236 | 84289 | 100 |
| | | 320C | 84237 | 84290 | 100 |
| | | 400C | 84238 | 84291 | 100 |
| | | 500C | 84239 | 84292 | 100 |
| | | 600C | - | 84293 | 100 |

Waterproof Silicon Carbide (CW-C)

- Extremely long lasting
- Closed coat structure for more material removal
- Use wet or dry

WOOD Varnish, plastic, fiberglass, clear coat, primer

CONCRETE Marble, ceramics

METAL Ferrous and/or non-ferrous metals

- Available in grits up to 2000 for ultra fine finishing
- Available in C-weight - medium weight, medium flexibility

Waterproof Silicon Carbide

| Size | Grit Wgt. | Part No. | Std Pkg. |
|----------------|-----------|----------|----------|
| 9 x 11 CW-C | 80C | 84249 | 100 |
| | 100C | 84250 | 100 |
| | 120C | 84251 | 100 |
| | 150C | 84252 | 100 |
| | 180C | 84253 | 100 |
| | 220C | 84254 | 100 |
| | 240C | 84255 | 100 |
| | 320C | 84256 | 100 |
| | 400C | 84257 | 100 |
| | 500C | 84258 | 100 |
| | 600C | 84259 | 100 |
| | 800C | 84260 | 100 |
| 5-1/2 x 9 CW-C | 1200C | 84261 | 100 |
| | 1000C | 84270 | 50 |
| | 1200C | 84271 | 50 |
| | 1500C | 84274 | 50 |
| | 2000C | 84277 | 50 |



Fileboard

4S Premium Fileboard Sheets/Rolls

- EXCELS ON PAINTED SURFACES
- Premium Aluminum Oxide grain
- Top quality stearate coating and open coat structure lubricates and prevents loading
- Best choice for auto body applications
- Roll form allows user to cut roll as needed
- Available in PSA, hook & loop, Clip-on and Rolls



3S PSA Fileboard Sheets

- AUTOBODY AND BARE METAL APPLICATIONS
- Aluminum Oxide grain
- Stearate coating and open coat structure lubricates and prevents loading
- Excellent choice for general auto body work

WOOD Auto body filler, paint and fiberglass

METAL Ferrous and/or non-ferrous metals

4S PSA

4S H&L

4S Clip-on

4S PSA Rolls

3S PSA

| Size | Grit Wgt. | Part No. | Std Pkg. |
|-----------------|-----------|----------|----------|
| 2-3/4 x 16-1/2 | 80 | 84351 | 25 |
| | 100 | 84352 | 25 |
| | 120 | 84353 | 25 |
| | 150 | 84354 | 25 |
| | 180 | 84355 | 25 |
| | 220 | 84356 | 25 |
| 2-3/4 x 16-1/2 | 320 | 84359 | 25 |
| | 400 | 84360 | 25 |
| | 80 | 84371 | 25 |
| | 100 | 84372 | 25 |
| | 120 | 84373 | 25 |
| | 150 | 84374 | 25 |
| 2-3/4 x 17-1/2 | 180 | 84375 | 25 |
| | 220 | 84376 | 25 |
| | 320 | 84379 | 25 |
| | 400 | 84380 | 25 |
| | 80 | 84331 | 25 |
| | 100 | 84332 | 25 |
| 2-3/4 x 17-1/2 | 120 | 84333 | 25 |
| | 150 | 84334 | 25 |
| | 180 | 84335 | 25 |
| | 220 | 84336 | 25 |
| | 320 | 84339 | 25 |
| | 400 | 84340 | 25 |
| 2-3/4 x 25 yds. | 80 | 34770 | 1 |
| | 120 | 34772 | 1 |
| | 150 | 34773 | 1 |
| | 180 | 34774 | 1 |
| | 220 | 34775 | 1 |
| | 280 | 34776 | 1 |
| 2-3/4 x 16-1/2 | 320 | 34777 | 1 |
| | 400 | 34778 | 1 |
| | 80C | 84113 | 25 |
| | 100C | 84114 | 25 |
| | 120C | 84115 | 25 |
| 2-3/4 x 16-1/2 | 150C | 84116 | 25 |
| | 180C | 84117 | 25 |



- Standard sizes for use in straight inline sanders and hand files with clip-on, PSA and hook and loop designs
- Available in 3 grain types
- High loft hook and loop backing provides optimum attachment
- For dry use only

COATED ABRASIVES

SHEETS



Zirconium Fileboard Sheets (Z-F)

- Premium Zirconium grain for aggressive stock removal and sanding
- Heavy duty F-weight prevents torn edges which produce deep, uneven, random scratches
- Best choice for heavy sanding and shaping on contours
- Available in hook and loop, PSA, and clip-on

Aluminum Oxide clip-on Fileboard Sheets

- Aluminum Oxide grain
- Open coat structure prevents loading

Silicon Carbide No Load

- Silicon Carbide grain
- Stearate coating to reduce loading



WOOD Auto body filler, paint and fiberglass

METAL Ferrous and/or non-ferrous metals



| | Size | Grit Wgt. | Part No. | Std Pkg. |
|-----------------------|----------------|-----------|----------|----------|
| Z-F PSA | 2-3/4 | 40 | 83110 | 25 |
| | x | 80 | 83113 | 25 |
| | 16-1/2 | 40 | 83140 | 25 |
| Z-F H&L | 2-3/4 | 80 | 83143 | 25 |
| | x | 40 | 83170 | 25 |
| Z-F clip-on | 17-1/2 | 80 | 83173 | 25 |
| | | | | |
| Aluminum Oxide | 2-3/4 | 36D | 84170 | 50 |
| | x | 40D | 84171 | 50 |
| | 17-1/2 | 60D | 84172 | 100 |
| | | 80D | 84173 | 100 |
| | | 100C | 84174 | 100 |
| No Load | 2-3/4 x 17-1/2 | 180B | 84185 | 200 |



- Standard sizes for use in straight inline sanders and hand files with clip-on, PSA and hook and loop designs
- Available in 3 grain types
- High loft hook and loop backing provides optimum attachment
- For dry use only

COATED
ABRASIVES

SHEETS



Saitscreen™

- Strong cloth screen impregnated with silicon carbide grain
- Open coat structure prevents loading
- Use wet or dry
- Extremely long lasting
- Double sided and die cut

WOOD Plaster, dry wall joints

Paper

- Aluminum oxide grain
- Paper backing
- Open coat structure prevents loading
- Use dry
- Provides a smooth finish
- Easy-to-handle rolls for on-the-job "cut to size" use

WOOD Plaster, dry wall joints

Saitscreen™ 9 x 11 Sheets

- Cloth screen impregnated with silicon carbide grain
- Use wet or dry
- Non-loading
- Strong, long lasting

WOOD Body filler, paint, fiberglass

CONCRETE Ceramic, marble, cement

METAL Ferrous and/or non-ferrous metals



| Size | Grit Wgt. | Part No. | Std Pkg. |
|----------------------------|------------------------------|----------|----------|
| Saitscreen™ 4-3/16 x 11 | 80 | 84070 | 50 |
| | 100 | 84071 | 50 |
| | 220 | 84075 | 50 |
| Diecut | 80C | 84066 | 100 |
| | 100C | 84067 | 100 |
| | 120C | 84068 | 100 |
| Paper 3-5/16 x 11 | 150C | 84069 | 100 |
| | 80C | 84051 | 100 |
| | 100C | 84050 | 100 |
| Diecut | 120C | 84052 | 100 |
| | 150C | 84053 | 100 |
| | Paper 3-5/16 x 50 yds. | 80C | 84056 |
| 100C | | 84057 | 1 |
| 120C | | 84058 | 1 |
| Saitscreen™ 9 x 11 | 150C | 84059 | 1 |
| | 80 | 84076 | 25 |
| | 100 | 84077 | 25 |
| | 120 | 84078 | 25 |
| | 150 | 84079 | 25 |

Tech INFO

- Available in screen or paper sheets offering the best product for your application
- Open coat structures on both backings prevents clogging and loading in extreme applications

COATED
ABRASIVES

SHEETS



Hand Sanding

Sanding Sponges

- Premium abrasive grain on a soft, foam backing
- Foam backing provides ultimate conformability and is washable for long life
- For use on wood moldings, metal contours, drywall sanding, and paint removal applications

WOOD Hardwoods and softwoods, plastic, paint fiberglass, auto body filler, and drywall compounds

METAL Ferrous and/or non-ferrous metals



Hi Density Sanding Block

Contour Sanding Pad

Fabric Reinforced Sanding Pad

| Size | Grit Available | Part Nos. | Qty Per Box |
|------|----------------|-----------|-------------|
| 1" | 60 | 86355 | 24 |
| | 80 | 86356 | 24 |
| | 100 | 86357 | 24 |
| | 120 | 86359 | 24 |
| | 180 | 86360 | 24 |
| 5 mm | 60 | 86445 | 100 |
| | 100 | 86447 | 100 |
| | 180 | 86450 | 100 |
| | 280 | 86451 | 100 |
| 1/2" | 60 | 86475 | 24 |
| | 100 | 86477 | 24 |
| | 150 | 86479 | 24 |
| | 180 | 86480 | 24 |
| | 220 | 86481 | 24 |



- Sanding sponges can be used wet or dry for fine finishing and can be washed to extend cutting life (just wash with water)
- In general, the finish of sanding sponges will be finer than traditional coated abrasives
- Due to the ability to conform to different shapes, sanding sponges are able to sand and finish in hard to reach areas

COATED ABRASIVES

SHEETS



Industrial Rolls - EA-F

- Aluminum oxide grain
- Premium quality EA-F material for very high flexibility
- High tensile strength, extra durable backing
- Long life
- Primarily for machine applications

METAL Ferrous and/or non-ferrous metals (iron, aluminum, copper, normal and high tensile steel)

WOOD Wood, fiberglass, etc.

Handy Rolls - DA-F

- Aluminum oxide grain
- High quality DA-F material for high flexibility
- Medium tensile strength
- Primarily for hand applications

METAL Ferrous and/or non-ferrous materials (iron, aluminum, copper, normal and high tensile steel)

WOOD Wood, fiberglass, etc.



COATED ABRASIVES

SHOP ROLLS

Packaging
50 yd length, 1/box

| EA-F Industrial Rolls | | Size Width | Grit | Part No. |
|-----------------------|-----|------------|------|----------|
| 1" | | | 40 | 80415 |
| | | | 50 | 80515 |
| | | | 60 | 80615 |
| | | | 80 | 80815 |
| | | | 100 | 81015 |
| | | | 120 | 81215 |
| | | | 150 | 81515 |
| | | | 180 | 81815 |
| | | | 220 | 82215 |
| | | | 240 | 82415 |
| 1-1/2" | | | 320 | 83215 |
| | | | 400 | 83415 |
| | | | 40 | 80416 |
| | | | 50 | 80516 |
| | | | 60 | 80616 |
| | | | 80 | 80816 |
| | | | 100 | 81016 |
| | | | 120 | 81216 |
| | | | 150 | 81516 |
| | | | 180 | 81816 |
| 2" | | | 220 | 82216 |
| | | | 240 | 82416 |
| | | | 320 | 83216 |
| | | | 400 | 83416 |
| | | | 40 | 80430 |
| | | | 50 | 80530 |
| | | | 60 | 80630 |
| | | | 80 | 80830 |
| | | | 100 | 81030 |
| | | | 120 | 81230 |
| | 150 | 81530 | | |
| | 180 | 81830 | | |
| | 220 | 82230 | | |
| | 240 | 82430 | | |
| | 320 | 83230 | | |
| | 400 | 83430 | | |

| DA-F Handy Rolls | | Size Width | Grit | Part No. |
|------------------|-----|------------|------|----------|
| 1" | | | 40 | 80405 |
| | | | 50 | 80505 |
| | | | 60 | 80605 |
| | | | 80 | 80805 |
| | | | 100 | 81005 |
| | | | 120 | 81205 |
| | | | 150 | 81505 |
| | | | 180 | 81805 |
| | | | 220 | 82205 |
| | | | 240 | 82405 |
| 1-1/2" | | | 320 | 83205 |
| | | | 400 | 83405 |
| | | | 40 | 80406 |
| | | | 50 | 80506 |
| | | | 60 | 80606 |
| | | | 80 | 80806 |
| | | | 100 | 81006 |
| | | | 120 | 81206 |
| | | | 150 | 81506 |
| | | | 180 | 81806 |
| 2" | | | 220 | 82206 |
| | | | 240 | 82406 |
| | | | 320 | 83206 |
| | | | 400 | 83406 |
| | | | 40 | 80420 |
| | | | 50 | 80520 |
| | | | 60 | 80620 |
| | | | 80 | 80820 |
| | | | 100 | 81020 |
| | | | 120 | 81220 |
| | 150 | 81520 | | |
| | 180 | 81820 | | |
| | 220 | 82220 | | |
| | 240 | 82420 | | |
| | 320 | 83220 | | |
| | 400 | 83420 | | |



- Resin over resin construction for a strong bond resistant to heat and moisture
- Egyptian cotton cloth backing for superior durability
- Available in 2 tensile strengths for a wide range of applications
- Open coat structure prevents loading
- Box label UPC bar coded for easy identification and inventory maintenance



DA-F Mini Shop Rolls

- Aluminum oxide grain
- DA-F material for high flexibility
- Open coat structure prevents loading
- For hand applications

- METAL** Ferrous and/or non-ferrous materials
- WOOD** Wood, fiberglass, etc.

Packaging
10 yard lengths

| DA-F Mini Shop Rolls | Size | Grit | Part No. |
|----------------------|------------------|------|----------|
| | 1-1/2" x 10 yds. | 60 | 80607 |
| | | 80 | 80807 |
| | | 120 | 81207 |
| | | 180 | 81807 |



EA-F Custom Rolls

- Premium quality EA-F material for very high flexibility used in industrial rolls
- Open coat structure prevents loading

DA-F Custom Rolls

- Flexible DA-F material used in handy rolls
- Open coat structure prevents loading

- METAL** Ferrous and/or non-ferrous materials
- WOOD** Wood, fiberglass, etc.

Can be slit up to 3 cuts, 3" minimum width
Specify widths when ordering

| EA-F Custom Rolls | Size Width | Grit | Part No. |
|-------------------|------------|------|----------|
| | 12" | 40 | 81640 |
| | | 50 | 81650 |
| | | 60 | 81660 |
| | | 80 | 81680 |
| | | 100 | 81610 |
| | | 120 | 81612 |
| | | 150 | 81615 |
| | | 180 | 81618 |
| | | 220 | 81622 |
| | | 240 | 81624 |
| | | 320 | 81632 |
| | | 400 | 81604 |

Packaging
50 yard lengths

| DA-F Custom Rolls | Size Width | Grit | Part No. |
|-------------------|------------|------|----------|
| | 12" | 40 | 81440 |
| | | 50 | 81450 |
| | | 60 | 81460 |
| | | 80 | 81480 |
| | | 100 | 81410 |
| | | 120 | 81412 |
| | | 150 | 81415 |
| | | 180 | 81418 |
| | | 220 | 81422 |
| | | 240 | 81424 |
| | | 320 | 81432 |
| | | 400 | 81404 |



- Resin over resin construction for a strong bond resistant to heat and moisture
- Egyptian cotton cloth backing for superior durability
- Available in 2 tensile strengths for a wide range of applications
- Open coat structure prevents loading
- Box label UPC bar coded for easy identification and inventory maintenance

COATED
ABRASIVES

SHOP ROLLS



Saitscreen™ Rolls

- Silicon carbide grain
- Long life
- Waterproof
- Non-loading screen cloth

METAL Ferrous and/or non-ferrous metals (steel, solder, copper)

CONCRETE Ceramic

WOOD Wood, paint, etc.

Individually packaged rolls

| Saitscreen™ Rolls | Size Width | Grit | Part No. |
|-------------------|------------|------|----------|
| 1-1/2" x 5 yds. | | 80 | 84089 |
| | | 120 | 84092 |
| | | 180 | 84095 |
| 1-1/2" x 10 yds. | | 80 | 84090 |
| | | 120 | 84093 |
| | | 180 | 84096 |
| 1-1/2" x 25 yds. | | 80 | 84091 |
| | | 120 | 84094 |
| | | 180 | 84097 |



Plumber Rolls

- Aluminum oxide grain
- Open coat structure prevents loading
- Use dry only
- Excellent for cleaning pipe ends

METAL Ferrous and/or non-ferrous materials, copper piping

Packaged 1/box

Plumber Rolls

| Size Width | Grit | Part No. |
|-----------------|------|----------|
| 1-1/2" x 25 yds | 120 | 80000 |



Saitscreen™ Rolls

- Double sided for long life
- Box label UPC bar coded for easy identification and inventory maintenance

Plumber Rolls

- Box label UPC bar coded for easy identification and inventory maintenance
- Cloth backed for durability and flexibility



Die Grinder

TA-X

Premium Aluminum Oxide Grain

- Excellent for removing parting lines, imperfections, and burrs on all surfaces
- Great in curved, corner, contoured, and hard to reach areas

- METAL** Ferrous and/or non-ferrous metals
- STAINLESS** Stainless steel, high tensile steel, wood

See page 147 for Drums



Spiral Bands

| Size | Grit | Max RPM | Part Nos. | Qty Per Box |
|---------------|------|---------|-----------|-------------|
| 1/2 x 1/2 | 60 | 30,000 | 42001 | 100 |
| | 80 | 30,000 | 42002 | 100 |
| | 120 | 30,000 | 42003 | 100 |
| 1/2 x 1 | 60 | 15,000 | 42006 | 100 |
| | 80 | 15,000 | 42007 | 100 |
| | 120 | 15,000 | 42008 | 100 |
| 1/2 x 1-1/2 | 60 | 12,000 | 42011 | 100 |
| | 80 | 12,000 | 42012 | 100 |
| | 120 | 12,000 | 42013 | 100 |
| 3/4 x 1 | 36 | 19,000 | 42016 | 100 |
| | 60 | 19,000 | 42017 | 100 |
| | 80 | 19,000 | 42018 | 100 |
| 3/4 x 1-1/2 | 120 | 19,000 | 42019 | 100 |
| | 60 | 10,000 | 42022 | 100 |
| | 80 | 10,000 | 42023 | 100 |
| 1 x 1 | 120 | 10,000 | 42024 | 100 |
| | 36 | 18,000 | 42027 | 100 |
| | 60 | 18,000 | 42028 | 100 |
| 1-1/2 x 1 | 80 | 18,000 | 42029 | 100 |
| | 120 | 18,000 | 42030 | 100 |
| | 36 | 14,000 | 42033 | 100 |
| 1-1/2 x 1-1/2 | 60 | 14,000 | 42034 | 100 |
| | 80 | 14,000 | 42035 | 100 |
| | 120 | 14,000 | 42036 | 100 |
| 2 x 2 | 36 | 10,000 | 42039 | 100 |
| | 60 | 10,000 | 42040 | 100 |
| | 80 | 10,000 | 42041 | 100 |
| 3 x 3 | 120 | 10,000 | 42042 | 100 |
| | 36 | 6,000 | 42045 | 50 |
| | 60 | 6,000 | 42046 | 50 |
| 3 x 3 | 80 | 6,000 | 42047 | 50 |
| | 120 | 6,000 | 42048 | 50 |
| | 36 | 3,000 | 42051 | 50 |
| 3 x 3 | 60 | 3,000 | 42052 | 50 |
| | 80 | 3,000 | 42053 | 50 |
| | 120 | 3,000 | 42054 | 50 |



COATED
ABRASIVES

SPECIALTIES



- Single ply of coated abrasive, spirally wound and bonded to an inner liner
- Quick removal and installation
- Smooth running for ease of use and control

Cartridge Rolls



Die Grinder

SPECIALTIES

TA-X - Straight

Premium Aluminum Oxide Grain

- Excellent for sanding and polishing channels, fillets, recesses, side walls, and bottoms of dead-end holes
- Great for high speed deburring and flash removal

METAL Ferrous and/or non-ferrous metals

STAINLESS Stainless steel, high tensile steel

Packaging 100/box

See page 147 for Cartridge Roll mandrels

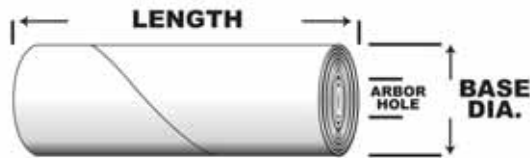

| Size B x L x A | Grit | Max RPM | Cartridge Roll Part Nos. | Mandrel Part Nos. |
|-----------------------|------|------------|--------------------------------|----------------------|
| 3/16 x 1 x 3/32 | 80 | 26,000 | 38001 | 95108 |
| | 120 | 26,000 | 38003 | 95108 |
| 1/4 x 1 x 1/8 | 60 | 26,000 | 38007 | 95105 |
| | 80 | 26,000 | 38008 | 95105 |
| | 120 | 26,000 | 38010 | 95105 |
| 1/4 x 1-1/2 x 1/8 | 320 | 26,000 | 38013 | 95105 |
| | 60 | 26,000 | 38014 | 95104 |
| | 80 | 26,000 | 38015 | 95104 |
| 1/4 x 2 x 1/8 | 120 | 26,000 | 38017 | 95104 |
| | 240 | 26,000 | 38019 | 95104 |
| | 60 | 26,000 | 38021 | 95103 |
| 5/16 x 1 x 1/8 | 80 | 26,000 | 38022 | 95103 |
| | 120 | 26,000 | 38023 | 95103 |
| | 60 | 26,000 | 38027 | 95105 |
| 5/16 x 1-1/2 x 1/8 | 80 | 26,000 | 38028 | 95105 |
| | 120 | 26,000 | 38029 | 95105 |
| | 60 | 26,000 | 38033 | 95104 |
| 3/8 x 1 x 1/8 | 80 | 26,000 | 38034 | 95104 |
| | 60 | 26,000 | 38040 | 95105 |
| | 80 | 26,000 | 38041 | 95105 |
| 3/8 x 1-1/2 x 1/8 | 120 | 26,000 | 38043 | 95105 |
| | 50 | 26,000 | 38047 | 95104 |
| | 60 | 26,000 | 38048 | 95104 |
| 3/8 x 2 x 1/8 | 80 | 26,000 | 38049 | 95104 |
| | 120 | 26,000 | 38051 | 95104 |
| | 60 | 26,000 | 38055 | 95103 |
| 1/2 x 1 x 1/8 | 80 | 26,000 | 38056 | 95103 |
| | 120 | 26,000 | 38058 | 95103 |
| | 50 | 26,000 | 38062 | 95105 |
| 1/2 x 2 x 1/4 | 60 | 26,000 | 38063 | 95105 |
| | 80 | 26,000 | 38064 | 95105 |
| | 120 | 26,000 | 38066 | 95105 |

| Size B x L x A | Grit | Max RPM | Cartridge Roll Part Nos. | Mandrel Part Nos. |
|-----------------------|------|------------|--------------------------------|----------------------|
| 1/2 x 1-1/2 x 1/8 | 36 | 26,000 | 38070 | 95104 |
| | 40 | 26,000 | 38071 | 95104 |
| | 50 | 26,000 | 38072 | 95104 |
| | 60 | 26,000 | 38073 | 95104 |
| 1/2 x 2 x 1/8 | 80 | 26,000 | 38074 | 95104 |
| | 120 | 26,000 | 38076 | 95104 |
| | 60 | 26,000 | 38080 | 95103 |
| | 80 | 26,000 | 38081 | 95103 |
| 1/2 x 2 x 3/16 | 120 | 26,000 | 38083 | 95103 |
| | 60 | 26,000 | 38087 | 95106 |
| | 80 | 26,000 | 38088 | 95106 |
| 5/8 x 1-1/2 x 1/8 | 120 | 26,000 | 38089 | 95106 |
| | 60 | 18,000 | 38093 | 95104 |
| | 80 | 18,000 | 38094 | 95104 |
| 3/4 x 1-1/2 x 3/16 | 120 | 18,000 | 38095 | 95104 |
| | 40 | 18,000 | 38112 | 95107 |
| | 60 | 18,000 | 38113 | 95107 |
| 3/4 x 2 x 3/16 | 80 | 18,000 | 38114 | 95107 |
| | 120 | 18,000 | 38115 | 95107 |
| | 40 | 18,000 | 38119 | 95106 |
| 1 x 1-1/2 x 1/4 | 60 | 18,000 | 38120 | 95106 |
| | 80 | 18,000 | 38121 | 95106 |
| | 120 | 18,000 | 38122 | 95106 |
| 1 x 2 x 1/4 | 60 | 18,000 | 38126 | 95102 |
| | 80 | 18,000 | 38127 | 95102 |
| | 120 | 18,000 | 38128 | 95102 |
| 1 x 2 x 1/4 | 60 | 18,000 | 38132 | 95101 |
| | 80 | 18,000 | 38133 | 95101 |
| | 120 | 18,000 | 38134 | 95101 |

COATED
ABRASIVES

SPECIALTIES



- Multi-layer, self dressing construction - exposes sharp, new cutting abrasive as each layer wears away.
- Available in straight and full taper designs - long lasting performance.
- Quick removal and installation - less downtime.



Die Grinder

TA-X - Full Taper

Premium Aluminum Oxide Grain

- Excellent for sanding and polishing channels, fillets, recesses, side walls, and bottoms of dead-end holes
- Great for high speed deburring and flash removal

METAL Ferrous and/or non-ferrous metals

STAINLESS Stainless steel, high tensile steel

Packaging
100/box

See page 147 for Cartridge Roll mandrels

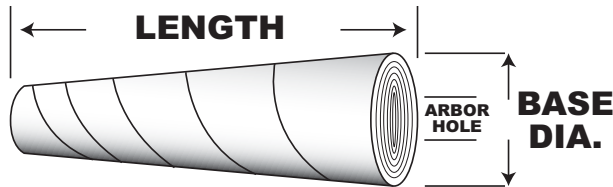

| Base Dia. | Size | | Grit | Max RPM | Cartridge Roll Part Nos. | Mandrel Part Nos. |
|-----------|--------|------------|------|---------|--------------------------|-------------------|
| | Length | Arbor Hole | | | | |
| 3/8 | 1 | 1/8 | 60 | 26,000 | 38300 | 95105 |
| 3/8 | 1 | 1/8 | 80 | 26,000 | 38301 | 95105 |
| 3/8 | 1 | 1/8 | 120 | 26,000 | 38302 | 95105 |
| 3/8 | 1-1/2 | 1/8 | 60 | 26,000 | 38306 | 95104 |
| 3/8 | 1-1/2 | 1/8 | 80 | 26,000 | 38307 | 95104 |
| 3/8 | 1-1/2 | 1/8 | 120 | 26,000 | 38308 | 95104 |
| 1/2 | 1 | 1/8 | 60 | 26,000 | 38312 | 95105 |
| 1/2 | 1 | 1/8 | 80 | 26,000 | 38313 | 95105 |
| 1/2 | 1 | 1/8 | 120 | 26,000 | 38314 | 95105 |
| 1/2 | 1-1/2 | 1/8 | 50 | 26,000 | 38318 | 95104 |
| 1/2 | 1-1/2 | 1/8 | 60 | 26,000 | 38319 | 95104 |
| 1/2 | 1-1/2 | 1/8 | 80 | 26,000 | 38320 | 95104 |
| 1/2 | 1-1/2 | 1/8 | 120 | 26,000 | 38322 | 95104 |
| 1/2 | 2 | 1/8 | 60 | 26,000 | 38326 | 95103 |
| 1/2 | 2 | 1/8 | 80 | 26,000 | 38327 | 95103 |
| 1/2 | 2 | 1/8 | 120 | 26,000 | 38328 | 95103 |
| 5/8 | 2 | 1/8 | 60 | 18,000 | 38332 | 95103 |
| 5/8 | 2 | 1/8 | 80 | 18,000 | 38333 | 95103 |
| 5/8 | 2 | 1/8 | 120 | 18,000 | 38334 | 95103 |
| 3/4 | 1-1/2 | 1/8 | 60 | 18,000 | 38338 | 95104 |
| 3/4 | 1-1/2 | 1/8 | 80 | 18,000 | 38339 | 95104 |
| 3/4 | 1-1/2 | 1/8 | 120 | 18,000 | 38340 | 95104 |
| 3/4 | 2 | 3/16 | 60 | 18,000 | 38344 | 95106 |
| 3/4 | 2 | 3/16 | 80 | 18,000 | 38345 | 95106 |
| 3/4 | 2 | 3/16 | 120 | 18,000 | 38346 | 95106 |

COATED
ABRASIVES

SPECIALTIES

Tech INFO

- Multi-layer, self dressing construction - exposes sharp, new cutting abrasive as each layer wears away.
- Available in straight and full taper designs - long lasting performance.
- Quick removal and installation - less downtime.



Die Grinder

Cross Pads

| Size | Mandrel Size | Grit | Recommended RPM Range | Max RPM | Part No. | Qty Per Box |
|-------------|--------------|------|-----------------------|---------|----------|-------------|
| 1 x 3/8 | 3-48 | 60 | 20,000-23,000 | 25,000 | 48036 | 50 |
| | 3-48 | 80 | 20,000-23,000 | 25,000 | 48037 | 50 |
| | 3-48 | 120 | 20,000-23,000 | 25,000 | 48038 | 50 |
| 1-1/2 x 1/2 | 8-32 | 60 | 19,000-20,000 | 23,000 | 48041 | 50 |
| | 8-32 | 80 | 19,000-20,000 | 23,000 | 48042 | 50 |
| 2 x 1/2 | 8-32 | 120 | 19,000-20,000 | 23,000 | 48043 | 50 |
| | 8-32 | 60 | 19,000-20,000 | 23,000 | 48046 | 50 |
| | 8-32 | 80 | 19,000-20,000 | 23,000 | 48047 | 50 |
| 2 x 1 | 8-32 | 120 | 19,000-20,000 | 23,000 | 48048 | 50 |
| | 1/4-20 | 60 | 19,000-20,000 | 23,000 | 48051 | 50 |
| | 1/4-20 | 80 | 19,000-20,000 | 23,000 | 48052 | 50 |
| 3 x 1 | 1/4-20 | 120 | 19,000-20,000 | 23,000 | 48053 | 50 |
| | 1/4-20 | 60 | 10,000-12,000 | 14,000 | 48056 | 50 |
| | 1/4-20 | 80 | 10,000-12,000 | 14,000 | 48057 | 50 |
| 4 x 1 | 1/4-20 | 120 | 10,000-12,000 | 14,000 | 48058 | 50 |
| | 1/4-20 | 60 | 9,000-10,000 | 14,000 | 48061 | 50 |
| | 1/4-20 | 80 | 9,000-10,000 | 14,000 | 48062 | 50 |
| | 1/4-20 | 120 | 9,000-10,000 | 14,000 | 48063 | 50 |

TA-X

Premium Aluminum Oxide Grain

- Excellent for deburring tubing, blending radii, polishing inside contours, and polishing and finishing bell-mouth configurations, drop forge and Kirksite dies

METAL Ferrous and/or non-ferrous metals

STAINLESS Stainless steel, high tensile steel



See page 147 for mandrels

Square Pads

| Size | Mandrel Size | Grit | Recommended RPM Range | Max RPM | Part No. | Qty Per Box |
|-------------|--------------|------|-----------------------|---------|----------|-------------|
| 1-1/2 x 1/4 | 8-32 | 60 | 19,000-20,000 | 23,000 | 48001 | 50 |
| | 8-32 | 80 | 19,000-20,000 | 23,000 | 48002 | 50 |
| | 8-32 | 120 | 19,000-20,000 | 23,000 | 48003 | 50 |
| 1-1/2 x 1/2 | 1/4-20 | 60 | 19,000-20,000 | 23,000 | 48006 | 50 |
| | 1/4-20 | 80 | 19,000-20,000 | 23,000 | 48007 | 50 |
| | 1/4-20 | 120 | 19,000-20,000 | 23,000 | 48008 | 50 |
| 2 x 1/4 | 8-32 | 60 | 19,000-20,000 | 23,000 | 48011 | 50 |
| | 8-32 | 80 | 19,000-20,000 | 23,000 | 48012 | 50 |
| | 8-32 | 120 | 19,000-20,000 | 23,000 | 48013 | 50 |
| 2 x 1/2 | 1/4-20 | 60 | 19,000-20,000 | 23,000 | 48016 | 50 |
| | 1/4-20 | 80 | 19,000-20,000 | 23,000 | 48017 | 50 |
| | 1/4-20 | 120 | 19,000-20,000 | 23,000 | 48018 | 50 |
| 2 x 3/4 | 1/4-20 | 60 | 19,000-20,000 | 23,000 | 48021 | 50 |
| | 1/4-20 | 80 | 19,000-20,000 | 23,000 | 48022 | 50 |
| | 1/4-20 | 120 | 19,000-20,000 | 23,000 | 48023 | 50 |
| 3 x 1/4 | 1/4-20 | 60 | 10,000-12,000 | 14,000 | 48026 | 50 |
| | 1/4-20 | 80 | 10,000-12,000 | 14,000 | 48027 | 50 |
| | 1/4-20 | 120 | 10,000-12,000 | 14,000 | 48028 | 50 |
| 3 x 1/2 | 1/4-20 | 60 | 10,000-12,000 | 14,000 | 48031 | 50 |
| | 1/4-20 | 80 | 10,000-12,000 | 14,000 | 48032 | 50 |
| | 1/4-20 | 120 | 10,000-12,000 | 14,000 | 48033 | 50 |

TA-X

Premium Aluminum Oxide Grain

- Excellent for grinding and blending on channels, fillets and corners, spotting on flat surfaces, and blending welds inside of pipes

METAL Ferrous and/or non-ferrous metals

STAINLESS Stainless steel, high tensile steel, wood



- Multi-ply abrasive pad - exposes new cutting surface as each layer wears
- Cushioned, chatter free grinding and polishing for long lasting performance

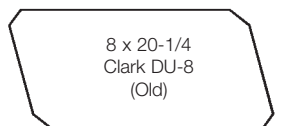
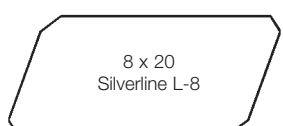
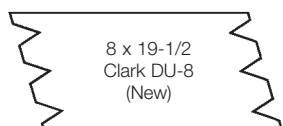
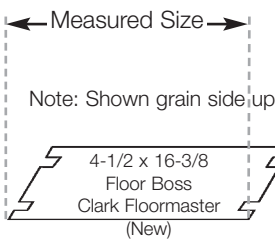
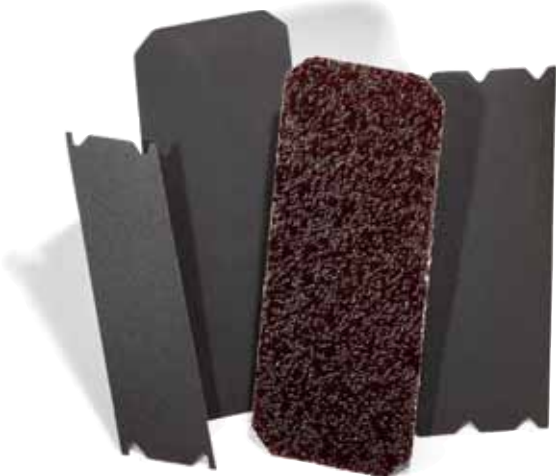

| Size | Grit Available | | Part Nos. | Qty Per Box |
|----------------|----------------|----------|-----------|-------------|
| | New Grit | Old Grit | | |
| 4-1/2 x 16-3/8 | 12 | 4-1/2 | 85049 | 50 |
| | 16 | 4 | 85050 | 50 |
| | 20 | 3-1/2 | 85051 | 50 |
| | 36 | 2 | 85052 | 50 |
| | 40 | 1-1/2 | 85053 | 50 |
| | 60 | 1/2 | 85054 | 50 |
| 8 x 19-1/2 | 80 | 0 | 85055 | 50 |
| | 100 | 2/0 | 85056 | 50 |
| | 12 | 4-1/2 | 85021 | 50 |
| | 16 | 4 | 85000 | 50 |
| | 20 | 3-1/2 | 85001 | 50 |
| | 36 | 2 | 85002 | 50 |
| 8 x 20 | 40 | 1-1/2 | 85003 | 50 |
| | 60 | 1/2 | 85004 | 50 |
| | 80 | 0 | 85005 | 50 |
| | 100 | 2/0 | 85006 | 50 |
| | 12 | 4-1/2 | 85022 | 50 |
| | 16 | 4 | 85007 | 50 |
| 8 x 20-1/4 | 20 | 3-1/2 | 85008 | 50 |
| | 36 | 2 | 85009 | 50 |
| | 40 | 1-1/2 | 85010 | 50 |
| | 60 | 1/2 | 85011 | 50 |
| | 80 | 0 | 85012 | 50 |
| | 100 | 2/0 | 85013 | 50 |
| 8 x 20-1/4 | 12 | 4-1/2 | 85023 | 50 |
| | 16 | 4 | 85014 | 50 |
| | 20 | 3-1/2 | 85015 | 50 |
| | 36 | 2 | 85016 | 50 |
| | 40 | 1-1/2 | 85017 | 50 |
| | 60 | 1/2 | 85018 | 50 |
| 8 x 20-1/4 | 80 | 0 | 85019 | 50 |
| | 100 | 2/0 | 85020 | 50 |

Sheets

Grits 12-20

- Silicon carbide grain
- Combination backing paper and cloth
- Open coat structure prevents loading
- Excellent for removing heavy finishes

WOOD Wood

Grits 36-100

- Silicon carbide grain
- Closed coat for more material removal
- Excellent for general refinishing

WOOD Wood

There are 2 grit grading systems for abrasive floor paper. Both systems appear in the table at left.



Belts - Cloth Grits 36-120

- Premium Zirconium grain for high stock removal and long life
- Belt design allows for quick changing of abrasive materials

WOOD Wood floors

| Size | Grit Available | Part Nos. | Qty Per Box |
|-----------------------|----------------|-----------|-------------|
| 8 x 19 AZ-X Zirconium | 36 | 85285 | 10 |
| | 50 | 85286 | 10 |
| | 60 | 85287 | 10 |
| | 80 | 85288 | 10 |
| | 120 | 85289 | 10 |



- Professional quality for use in tough industrial jobs
- Shrink wrapped for easy handling and long life
- Box label UPC bar coded for easy identification and inventory maintenance

COATED ABRASIVES

FLOOR SANDING

Sanding Discs

FLOOR SANDING



Edge Sander



Floor Sander

Grits 12-20

- Silicon carbide grain
- Combination backing paper and cloth
- Open coat structure prevents loading
- Excellent for removing heavy finishes

WOOD Wood

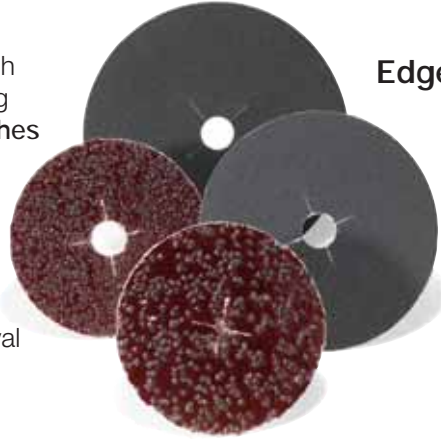

Edge

Grits 36-100

- Silicon carbide grain
- Closed coat for more material removal
- Excellent for general refinishing

WOOD Wood

There are 2 grit grading systems for abrasive floor paper. Both systems appear in the table.



Lg. Dia.

| Size | Grit Available | | Part Nos. | Qty Per Box |
|---------|----------------|----------|-----------|-------------|
| | New Grit | Old Grit | | |
| 5 x 1/4 | 12 | 4-1/2 | 85230 | 20 |
| | 16 | 4 | 85231 | 20 |
| | 20 | 3-1/2 | 85232 | 20 |
| | 36 | 2 | 85233 | 20 |
| | 40 | 1-1/2 | 85234 | 20 |
| | 60 | 1/2 | 85235 | 25 |
| 5 x 7/8 | 80 | 0 | 85236 | 25 |
| | 100 | 2/0 | 85237 | 25 |
| | 12 | 4-1/2 | 85207 | 20 |
| | 16 | 4 | 85200 | 20 |
| | 20 | 3-1/2 | 85201 | 20 |
| | 36 | 2 | 85202 | 20 |
| 6 x 7/8 | 40 | 1-1/2 | 85203 | 20 |
| | 60 | 1/2 | 85204 | 25 |
| | 80 | 0 | 85205 | 25 |
| | 100 | 2/0 | 85206 | 25 |
| | 12 | 4-1/2 | 85209 | 20 |
| | 16 | 4 | 85210 | 20 |
| 7 x 7/8 | 20 | 3-1/2 | 85211 | 20 |
| | 36 | 2 | 85212 | 20 |
| | 40 | 1-1/2 | 85213 | 20 |
| | 60 | 1/2 | 85214 | 25 |
| | 80 | 0 | 85215 | 25 |
| | 100 | 2/0 | 85216 | 25 |
| 15 x 2 | 12 | 4-1/2 | 85219 | 20 |
| | 16 | 4 | 85220 | 20 |
| | 20 | 3-1/2 | 85221 | 20 |
| | 36 | 2 | 85222 | 20 |
| | 40 | 1-1/2 | 85223 | 20 |
| | 60 | 1/2 | 85224 | 25 |
| 16 x 2 | 80 | 0 | 85225 | 25 |
| | 100 | 2/0 | 85226 | 25 |
| | 12 | 4-1/2 | 85121 | 20 |
| | 16 | 4 | 85100 | 20 |
| | 20 | 3-1/2 | 85101 | 20 |
| | 36 | 2 | 85102 | 20 |
| 17 x 2 | 40 | 1-1/2 | 85103 | 20 |
| | 60 | 1/2 | 85104 | 25 |
| | 80 | 0 | 85105 | 25 |
| | 100 | 2/0 | 85106 | 25 |
| | 12 | 4-1/2 | 85122 | 20 |
| | 16 | 4 | 85107 | 20 |
| 18 x 2 | 20 | 3-1/2 | 85108 | 20 |
| | 36 | 2 | 85109 | 20 |
| | 40 | 1-1/2 | 85110 | 20 |
| | 60 | 1/2 | 85111 | 25 |
| | 80 | 0 | 85112 | 25 |
| | 100 | 2/0 | 85113 | 25 |
| 20 x 2 | 12 | 4-1/2 | 85123 | 20 |
| | 16 | 4 | 85114 | 20 |
| | 20 | 3-1/2 | 85115 | 20 |
| | 36 | 2 | 85116 | 20 |
| | 40 | 1-1/2 | 85117 | 20 |
| | 60 | 1/2 | 85118 | 25 |
| 18 x 2 | 80 | 0 | 85119 | 25 |
| | 100 | 2/0 | 85120 | 25 |
| | 12 | 4-1/2 | 85130 | 20 |
| | 16 | 4 | 85131 | 20 |
| | 20 | 3-1/2 | 85132 | 20 |
| | 36 | 2 | 85133 | 20 |
| 20 x 2 | 40 | 1-1/2 | 85134 | 20 |
| | 60 | 1/2 | 85135 | 25 |
| | 80 | 0 | 85136 | 25 |
| | 100 | 2/0 | 85137 | 25 |
| | 12 | 4-1/2 | 85140 | 20 |
| | 16 | 4 | 85141 | 20 |
| 20 x 2 | 20 | 3-1/2 | 85142 | 20 |
| | 36 | 2 | 85143 | 20 |
| | 40 | 1-1/2 | 85144 | 20 |
| | 60 | 1/2 | 85145 | 25 |
| | 80 | 0 | 85146 | 25 |
| | 100 | 2/0 | 85147 | 25 |



- Professional quality for use in tough industrial jobs
- Shrink wrapped for easy handling and long life

COATED
ABRASIVES

FLOOR SANDING



Grits 12-20

- Silicon carbide grain
- Combination backing paper and cloth
- Open coat structure prevents loading
- Excellent for removing heavy finishes

WOOD Wood floors

Grits 36-100

- Silicon carbide grain
- Closed coat for more material removal
- Excellent for general refinishing

WOOD Wood floors

There are 2 grit grading systems for abrasive floor paper. Both systems appear in the table below.

| Size | Grit Available | | Part Nos. | Pack |
|----------------|----------------|----------|-----------|------|
| | New Grit | Old Grit | | |
| 8" x 50 yards | 12 | 4-1/2 | 85307 | 1 |
| | 16 | 4 | 85300 | 1 |
| | 20 | 3-1/2 | 85301 | 1 |
| | 36 | 2 | 85302 | 1 |
| | 40 | 1-1/2 | 85303 | 1 |
| | 60 | 1/2 | 85304 | 1 |
| | 80 | 0 | 85305 | 1 |
| 12" x 50 yards | 100 | 2/0 | 85306 | 1 |
| | 12 | 4-1/2 | 85407 | 1 |
| | 16 | 4 | 85400 | 1 |
| | 20 | 3-1/2 | 85401 | 1 |
| | 36 | 2 | 85402 | 1 |
| | 40 | 1-1/2 | 85403 | 1 |
| | 60 | 1/2 | 85404 | 1 |
| | 80 | 0 | 85405 | 1 |
| | 100 | 2/0 | 85406 | 1 |



- Professional quality for use in tough industrial jobs
- Box label UPC bar coded for easy identification and inventory maintenance



Nylon Floor Pads

WOOD Maintaining wood and tile floors

CONCRETE Ceramic tile, cement

- Available in 1" thick and 1/4" thin

Black

- Heavy aggressiveness
- For stripping heavy finishes

Green

- Medium aggressiveness
- For scrubbing and cleaning

Tan

- Light applications
- For buffing and polishing
- Also used between sander and Saitscreen™

White

- High gloss finish
- For buffing



| Size | Grades Available Part Numbers | | | | Qty Per Box | Lbs Per Box |
|-----------|----------------------------------|-------|-------|-------|-------------------|-------------------|
| | Black | Green | Tan | White | | |
| 13" thin | 86134 | 86133 | - | - | 10 | 3 |
| 13" thick | 87134 | 87133 | 87132 | 87131 | 5 | 3 |
| 15" thin | 86154 | 86153 | 86152 | - | 10 | 3 |
| 15" thick | 87154 | 87153 | 87152 | 87151 | 5 | 3 |
| 16" thin | 86164 | 86163 | 86162 | - | 10 | 4 |
| 16" thick | - | - | 87162 | 87161 | 5 | 4 |
| 17" thin | 86174 | 86173 | 86172 | - | 10 | 5 |
| 17" thick | 87174 | - | 87172 | - | 5 | 5 |
| 18" thin | 86184 | 86183 | 86182 | - | 10 | 6 |
| 18" thick | 87184 | 87183 | 87182 | 87181 | 5 | 6 |
| 20" thin | 86204 | 86203 | 86202 | - | 10 | 6 |
| 20" thick | 87204 | 87203 | 87202 | 87201 | 5 | 6 |



Saitscreen™ Discs

- Cloth screen impregnated with silicon carbide grain
- Long life
- Non-loading
- Double sided
- Excellent for removing paint and varnish from floors

WOOD Wood

CONCRETE Ceramic tile, cement

| Size | Grit | Part No. | Qty Per Box |
|------|------|----------|-------------------|
| 15" | 60 | 88506 | 10 |
| | 80 | 88508 | 10 |
| | 100 | 88510 | 10 |
| | 120 | 88512 | 10 |
| 16" | 60 | 88606 | 10 |
| | 80 | 88608 | 10 |
| | 100 | 88610 | 10 |
| | 120 | 88612 | 10 |
| 17" | 60 | 88706 | 10 |
| | 80 | 88708 | 10 |
| | 100 | 88710 | 10 |
| | 120 | 88712 | 10 |
| 18" | 60 | 88806 | 10 |
| | 80 | 88808 | 10 |
| | 100 | 88810 | 10 |
| | 120 | 88812 | 10 |
| 20" | 60 | 88006 | 10 |
| | 80 | 88008 | 10 |
| | 100 | 88010 | 10 |
| | 120 | 88012 | 10 |



Nylon Floor Pads

- Available in an assortment of grits for excellent coverage of a wide range of applications

Saitscreen™

- Cloth screen impregnated with silicon carbide grain for non-loading sanding
- Double sided for long life

COATED
ABRASIVES

FLOOR SANDING

FLOOR SANDING Nylon & Saitscreen™



- For orbital sanding machines

Saitscreen™

- Silicon carbide grain
- Long life
- Non-loading
- Double sided
- Excellent for removing paint and varnish

WOOD Wood

CONCRETE Concrete

Nylon Floor Pads

- See applications page 114

WOOD Wood

CONCRETE Concrete

| Size | Grit | Part No. | Qty Per Box |
|------------------------|-------------|----------|-------------|
| Saitscreen™ 12 x 24 | 80 | 88002 | 10 |
| | 100 | 88003 | 10 |
| | 120 | 88004 | 10 |
| Nylon 12 x 24 | Tan/Thin | 86122 | 10 |
| | Green/Thin | 86123 | 10 |
| | Black/Thin | 86124 | 10 |
| | White/Thick | 86121 | 5 |



- Non-gouging for safe use on all floor surfaces
- Popular with DIY homeowners for ease of use

COATED
ABRASIVES

FLOOR SANDING



NON-WOVEN INTRODUCTION

United Abrasives offers an extensive line of non-woven abrasives for use in a variety of applications. Non-woven abrasives are primarily used in the metalworking industry for changing the surface of material without removing or damaging the base materials. Essentially, non-woven abrasives are used as a final finishing step.

Constructed of nylon fibers, along with a resin binder to hold the nylon and the grains together, non-woven abrasives reduce the risk of under-cutting or gouging the workpiece. Combined with the non-loading characteristics of the open weave, these products are sure to become a favorite finishing tool.

Sand-Light™ Abrasive Hand Pads:

6 x 9 hand pads for hand use. See page 117 for details.

SAIT-LOK™ and SAIT-LOK-R™:

Surface conditioning discs 1-1/2", 2", 3", 4" discs for mechanical use. See page 119 for more information.

Surface Conditioning Discs:

4", 4-1/2", 5", 6", 7", 8" hook and loop discs for excellent removal of surface coatings and contaminants. Now available in Very Fine (Blue). See page 120 for details.

Surface Conditioning Belts:

High speed removal of surface coatings and contaminants. Available in coarse, medium and very fine. See page 118 for details.

SAIT-Strip™:

High speed stripping tool used for removing paint, rust or other contaminants from surfaces. See page 121 for product listing and details.

Flap Brushes:

Non-woven flap brushes provide a linear finish on a variety of materials. See page 122 for details.

Interleaf Flap Wheels:

Interleaf flap wheels are constructed with alternating flaps of surface conditioning material and coated abrasive material for a high cut rate and a uniform scratch pattern. See page 123 for details.

Unitized Wheels and Type 27:

Constructed by bonding and compressing layers of non-woven materials. Excellent for light deburring to fine finishing. See page 124-125 for details.

Convolute Wheels:

Dense, non-woven wheels for use in aggressive deburring, weld blending and polishing. See page 126 for details.



Brown

- Heavy duty
- Excellent for removing heavy rust and cleaning welds

METAL Ferrous and/or non-ferrous metals

Maroon

- General purpose
- For removing light rust
- Excellent for cleaning and brightening

METAL Ferrous and/or non-ferrous metals

Black

- For blending and finishing
- Excellent for paint removal

STAINLESS Stainless steel

METAL Ferrous and/or non-ferrous metals

Green

- General cleaning
- Excellent for stripping paint and varnish

METAL Ferrous and/or non-ferrous metals

WOOD Paint, varnish

Gray

- Ultra fine
- For light finishing
- Excellent for sanding before/between finish coats

METAL Non-ferrous metals

WOOD Wood

White

- Light duty
- For light cleaning and polishing

WOOD Fiberglass, vinyl, plastic

CONCRETE Ceramic



NON-WOVEN
ABRASIVES

NON-WOVEN

| Size | Grade | Color | Part Nos. | Pads Per Box |
|-------|-----------------|--------|-----------|--------------|
| 6 x 9 | Heavy Duty | Brown | 77440 | 20 |
| | General Purpose | Maroon | 77447 | 20 |
| | Stainless | Black | 77446 | 20 |
| | Stripper | Green | 77496 | 20 |
| | Ultra Fine | Gray | 77448 | 20 |
| | Light Duty | White | 77486 | 20 |

Handle available for uniform finishing on page 145



- Non-woven synthetic fiber impregnated with abrasive grain for surface conditioning without damage to or removal of base material. Resists loading and heat build-up
- Wet/dry construction for use in a wide range of applications
- Available in a variety of grades from heavy duty to polishing applications
- Reusable and long lasting design for economical use
- Box label UPC bar coded for easy identification and inventory maintenance

Belts



Benchstand



File Sander



Portable Sander



Backstand

NON-WOVEN

Brown

- Coarse
- Excellent for deburring, blending
- For use on mill marks, tool marks, to create a smooth transition on surface profiles

STAINLESS Stainless steel

METAL Ferrous and/or non-ferrous materials

WOOD Fiberglass and rubber

Maroon

- General purpose
- Excellent for blending and cleaning
- Reduce uneven edges on adjoining surfaces
- Remove coatings, gaskets, and surface discolorations

STAINLESS Stainless steel

METAL Ferrous and/or non-ferrous materials

WOOD Fiberglass and rubber

Blue

- Very fine
- Excellent for cleaning and finishing
- Reduce surface roughness
- Polish welds
- Use to apply cosmetic grain or scratch patterns

STAINLESS Stainless steel

METAL Ferrous and/or non-ferrous materials

WOOD Fiberglass and rubber



| Size | Coarse Brown | Medium Maroon | Very fine Blue | Qty Per Box |
|----------------|--------------|---------------|----------------|-------------|
| 1/2 x 18 | 77510 | 77511 | 77512 | 10 |
| 1/2 x 24 | 77515 | 77516 | 77517 | 10 |
| 3/4 x 18 | 77520 | 77521 | 77522 | 10 |
| 3/4 x 20-1/2 | 77575 | 77576 | 77577 | 10 |
| 3-1/2 x 15-1/2 | 77500 | 77501 | 77502 | 10 |
| 1 x 42 | 77525 | 77526 | - | 10 |
| 2 x 48 | 77530 | 77531 | - | 10 |
| 2 x 60 | 77535 | 77536 | - | 10 |
| 2 x 132 | 77550 | 77551 | - | 5 |
| 3 x 21 | 77570 | 77571 | 77572 | 10 |
| 3 x 24 | 77560 | 77561 | 77562 | 10 |
| 3 x 132 | 77555 | 77556 | - | 5 |
| 4 x 24 | 77565 | 77566 | 77567 | 10 |
| 6 x 48 | 77540 | 77541 | - | 5 |

Tech INFO

- Non-woven synthetic fiber impregnated with abrasive grain for surface conditioning without damage to or removal of base material. Resists loading and heat build-up
- Offered in very narrow widths for use on tight radii and hard to reach applications
- Flexible yet extra durable splice method for resistance to breaking or cracking under severe stress

NON-WOVEN ABRASIVES

NON-WOVEN



Brown

- Heavy duty
- Excellent for deburring, blending, cleaning, polishing

STAINLESS Stainless steel

METAL Ferrous and/or non-ferrous materials

WOOD Fiberglass, gaskets

Maroon

- General purpose
- Excellent for deburring, blending, cleaning, polishing

STAINLESS Stainless steel

METAL Ferrous and/or non-ferrous materials

WOOD Fiberglass, gaskets

Blue

- Very fine
- Excellent for cleaning and finishing

STAINLESS Stainless steel

METAL Ferrous and/or non-ferrous materials

WOOD Fiberglass, gaskets



SAIT-LOK™



All-metal attachment on disc ensures a secure fit to the backing pad

SAIT-LOK-R™



Nylon screw threaded hub for easy mounting to the backing pad



See page 145 for backing pads

Hook & Loop style discs in 4" - 8" available on page 120

See page 128 for Buffing Discs

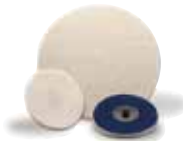

| Size | Grade | Color | SAIT-LOK™ Part No. | SAIT-LOK-R™ Part No. | Qty Per Box |
|--------|-----------|--------|--------------------|----------------------|-------------|
| 1-1/2" | Coarse | Brown | 77200 | 77300 | 50 |
| | Medium | Maroon | 77202 | 77302 | 50 |
| | Very Fine | Blue | 77203 | 77303 | 50 |
| 2" | Coarse | Brown | 77206 | 77306 | 50 |
| | Medium | Maroon | 77208 | 77308 | 50 |
| | Very Fine | Blue | 77209 | 77309 | 50 |
| 3" | Coarse | Brown | 77212 | 77312 | 25 |
| | Medium | Maroon | 77214 | 77314 | 25 |
| | Very Fine | Blue | 77215 | 77315 | 25 |
| 4" | Coarse | Brown | - | 77318 | 25 |
| | Medium | Maroon | - | 77320 | 25 |
| | Very Fine | Blue | - | 77321 | 25 |

NON-WOVEN ABRASIVES

NON-WOVEN



- For finer finishing prior to buffing, use Sand-Light™ blending discs on page 127
- Non-woven synthetic fiber coated with aluminum oxide grain resists loading for long life
- Flexible construction for use on contoured surfaces
- Non-woven disc can be switched to laminated disc using same backing pads for less downtime
- Box label UPC bar coded for easy identification and inventory maintenance

Discs



Disc Sander



Angle Grinder



Portable Grinder

NON-WOVEN HOOK & LOOP



See page 128 for Buffing Discs

Brown

- Heavy duty
- Excellent for removing surface coatings and contaminants, including rust

STAINLESS Stainless steel, high tensile steel

METAL Ferrous and/or non-ferrous materials

WOOD Fiberglass

Maroon

- General purpose
- Excellent for removing surface coatings and light rust

STAINLESS Stainless steel, high tensile steel

METAL Ferrous and/or non-ferrous materials

WOOD Fiberglass

Blue

- Very fine
- Excellent for blending and finishing

STAINLESS Stainless steel, high tensile steel

METAL Ferrous and/or non-ferrous materials

WOOD Fiberglass

A variety of 1/4" shank, 5/16-24 and 5/8-11 backing pads are available for use on drills, dual action/random orbital sanders, and right angle grinders/sanders. See page 145

SAIT-LOK™ & SAIT-LOK-R™ discs available in 1-1/2" - 3" on page 119

| Size | Grade | Color | Part No. | Qty Per Box |
|--------|-----------|--------|----------|-------------|
| 4" | Coarse | Brown | 77116 | 10 |
| | Medium | Maroon | 77117 | 10 |
| | Very Fine | Blue | 77115 | 10 |
| 4-1/2" | Coarse | Brown | 77118 | 10 |
| | Medium | Maroon | 77120 | 10 |
| | Very Fine | Blue | 77122 | 10 |
| 5" | Coarse | Brown | 77124 | 10 |
| | Medium | Maroon | 77126 | 10 |
| | Very Fine | Blue | 77128 | 10 |
| 6" | Coarse | Brown | 77130 | 10 |
| | Medium | Maroon | 77132 | 10 |
| | Very Fine | Blue | 77134 | 10 |
| 7" | Coarse | Brown | 77136 | 10 |
| | Medium | Maroon | 77138 | 10 |
| | Very Fine | Blue | 77140 | 10 |
| 8" | Coarse | Brown | 77142 | 10 |
| | Medium | Maroon | 77144 | 10 |
| | Very Fine | Blue | 77146 | 10 |

Tech INFO

- Hook and loop fastening system allows for quick changes and less downtime
- Non-woven synthetic fiber impregnated with abrasive grain for surface conditioning without damage to or removal of base material. Resists loading and heat build-up
- Used in a wide variety of applications including cleaning, polishing, blending, and deburring
- Resilient shape and performance characteristics for contour and radius applications
- Box label UPC bar coded for easy identification and inventory maintenance

NON-WOVEN
ABRASIVES

NON-WOVEN

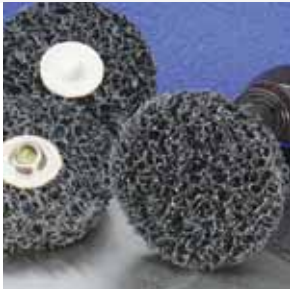

SAIT-Strip™ Discs

| Size | Max RPM | SAIT-LOK™ Part No. | SAIT-LOK-R™ Part No. | Qty Per Box |
|------|---------|--------------------|----------------------|-------------|
| 2" | 12,000 | 77250 | 77350 | 25 |
| 3" | 8,500 | 77255 | 77355 | 10 |

SAIT-Strip™

- Fast, safe removal of surface contaminants
- Available in SAIT-LOK™ , SAIT-LOK-R™ , Type 27, and spindle mounted wheels
- Excellent for cleaning welds, removing corrosion, rust, scaling, and blending
- Great for removing paints, varnishes and sealants from difficult to reach surfaces

- METAL** Ferrous and/or non-ferrous metals
- STAINLESS** Stainless steel, high tensile steel



SAIT-Strip™ Type 27

| Size | | | Max RPM | Part Number | Qty Per Box |
|--------|-------|------|---------|-------------|-------------|
| Dia. | Width | Bore | | | |
| 4-1/2" | 1/2" | 7/8" | 10,000 | 77230 | 4 |



SAIT-Strip™ Spindle Mounted Wheel

| Size | | | Max RPM | Part Number | Qty Per Box |
|------|-------|---------|---------|-------------|-------------|
| Dia. | Width | Mandrel | | | |
| 3" | 1-Ply | 1/4" | 10,000 | 77235 | 5 |
| 3" | 2-Ply | 1/4" | 10,000 | 77240 | 5 |

SAIT-Strip™ Arbor Hole Discs

- Fast, safe removal of surface contaminants
- Available in 4" x 1/4", 6" x 1/2", 8" x 1/2"

- METAL** Ferrous and/or non-ferrous metals
- STAINLESS** Stainless steel, high tensile steel

| Size | | | Max RPM | Part Number | Qty Per Box |
|------|-------|------|---------|-------------|-------------|
| Dia. | Width | Bore | | | |
| 4" | 1/2" | 1/4" | 6,000 | 77270 | 10 |
| 6" | 1/2" | 1/2" | 4,000 | 77275 | 5 |
| 8" | 1/2" | 1/2" | 3,000 | 77280 | 5 |

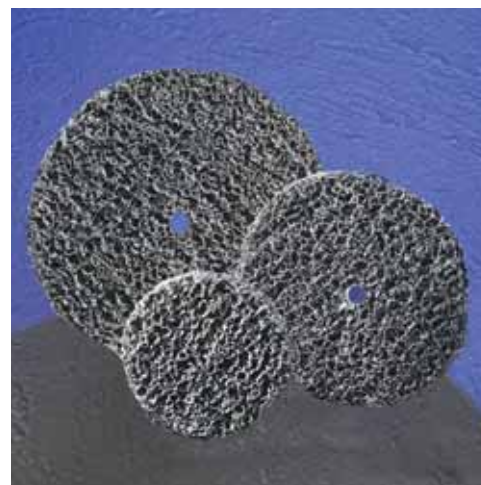

- Constructed of large nylon filament, providing an open, non-loading surface
- Utilizes coarse silicon carbide grain for rapid removal of surface contaminants, while producing fine finishes

Flap Brushes

NON-WOVEN



Pedestal Grinder

Flap Brushes

- Capable of conforming to concave, flat, and irregular surfaces
- Creates matte and satin finishes without lines on work piece
- Excellent for blending, cleaning welds, and removing corrosion, rust, or scaling
- Excellent for grain, antique, and satin finishes, finishing aluminum extrusions, and applying an inline brushed finish on aluminum and stainless steel

METAL Aluminum, brass

STAINLESS Stainless steel



| Size | Grade | Max RPM | Part No. | Qty Per Box |
|-----------|-----------|---------|----------|-------------|
| 6 x 1 x 2 | Medium | 3,400 | 77325 | 3 |
| | Very Fine | 3,400 | 77327 | 3 |
| 8 x 1 x 3 | Medium | 3,200 | 77330 | 3 |
| | Very Fine | 3,200 | 77332 | 3 |

See page 148 for mounting flanges and reducing bushings

Tech INFO

- Flexible, consistent face for ease of use
- Cool, smooth running for less operator fatigue
- Non-woven synthetic fiber impregnated with abrasive grain for surface conditioning without damage to or removal of base material. Resists loading and heat build-up

NON-WOVEN
ABRASIVES

NON-WOVEN



Medium Grade

- Medium surface conditioning material with either 60 or 80 grit coated abrasive material
- Excellent for removing heavy oxidation, blending, cleaning, and deburring

STAINLESS Aluminum and stainless steel

METAL Ferrous and non-ferrous materials

WOOD Fiberglass

Very Fine Grade

- Very fine surface conditioning material with either 120 or 180 grit coated abrasive material
- Excellent for grain finishing, satin finishing, and linear scratch patterns

STAINLESS Aluminum and stainless steel

METAL Ferrous and non-ferrous materials

WOOD Fiberglass



| Size | Grit | Grade | Max RPM | Part No. | Qty Per Box |
|-------------|------|-----------|---------|----------|-------------|
| 2 x 1 x 1/4 | 60 | Medium | 15,000 | 77710 | 10 |
| | 80 | Medium | 15,000 | 77712 | 10 |
| | 120 | Very Fine | 15,000 | 77714 | 10 |
| | 180 | Very Fine | 15,000 | 77716 | 10 |
| 3 x 1 x 1/4 | 60 | Medium | 12,000 | 77730 | 10 |
| | 80 | Medium | 12,000 | 77732 | 10 |
| | 120 | Very Fine | 12,000 | 77734 | 10 |
| | 180 | Very Fine | 12,000 | 77736 | 10 |
| 3 x 2 x 1/4 | 60 | Medium | 12,000 | 77750 | 5 |
| | 80 | Medium | 12,000 | 77752 | 5 |
| | 120 | Very Fine | 12,000 | 77754 | 5 |
| | 180 | Very Fine | 12,000 | 77756 | 5 |



- Interleaf flap wheels are constructed with alternating flaps of surface conditioning material and coated abrasive material for a high cut rate and a uniform scratch pattern. Provides blending action while leaving final finish on work piece
- Smear-resistant non-woven material for clean, smear-proof work surfaces
- Interleaf design makes product more aggressive than SAIT non-woven flap brushes and less aggressive than SAIT coated abrasive flap wheels



Unitized Type 27 Wheels

Series 524-Soft Density, Medium Grade, Silicon Carbide Grain

- General purpose cleaning, finishing and polishing

Series 732- Medium Density, Fine Grade, Silicon Carbide Grain

- Light pressure for blending and finishing
- High edge durability
- High degree of stock removal, while maintaining bright finish

Series 811- Hard Density, Coarse Grade, Aluminum Oxide Grain

- Highest stock removal and edge breaking capability
- Most aggressive for deburring

Series 821- Hard Density, Medium Grade, Aluminum Oxide Grain

- Provides high stock removal, long life and productivity
- Very durable on edge

STAINLESS Stainless steel, aluminum, high tensile steel

METAL Ferrous and/or non-ferrous metals

Go from a coarse grind finish to a near mirror finish with the Unitized Wheel



Unitized Type 27

| Size | Series | Grain | Density | Grade | Max RPM | Part No. | Qty Per Box |
|-------------|--------|-------|---------|--------|---------|----------|-------------|
| 4-1/2 x 7/8 | 524 | S/C | Soft | Medium | 10,000 | 77875 | 4 |
| 4-1/2 x 7/8 | 732 | S/C | Medium | Fine | 10,000 | 77880 | 4 |
| 4-1/2 x 7/8 | 811 | A/O | Hard | Coarse | 10,000 | 77885 | 4 |
| 4-1/2 x 7/8 | 821 | A/O | Hard | Medium | 10,000 | 77890 | 4 |



- Constructed by bonding and compressing layers of non-woven material
- Hot pressed to form a solid block from which wheels are cut

NON-WOVEN
ABRASIVES

NON-WOVEN



Unitized Wheels

Series 524-Soft Density, Medium Grade, Silicon Carbide Grain

- General purpose cleaning, finishing and polishing

Series 532-Soft Density, Fine Grade, Silicon Carbide Grain

- Requires light pressure for fine finishing and polishing
- Highly conformable material
- Provides clean, bright surface on stainless steel
- Finer finish than the 524 series

Series 632-Medium Density, Fine Grade, Silicon Carbide Grain

- Requires light pressure for fine finishing and polishing
- Highly conformable material
- Provides clean bright stainless steel finishes, blends tool marks, and removes slight surface imperfections

Series 731- Medium Density, Fine Grade, Aluminum Oxide Grain

- Light pressure for blending and finishing
- High edge durability
- High degree of stock removal, while maintaining bright finish
- Smaller contact area than the 632 series

Series 811- Hard Density, Coarse Grade, Aluminum Oxide Grain

- Highest stock removal and edge breaking capability
- Most aggressive for deburring

Series 821- Hard Density, Medium Grade, Aluminum Oxide Grain

- Provides high stock removal, long life and productivity
- Very durable on edge

STAINLESS Stainless steel, aluminum, high tensile steel

METAL Ferrous and/or non-ferrous metals



NON-WOVEN
ABRASIVES

NON-WOVEN

Unitized Wheels

| Size | Series | Grain | Density | Grade | Max RPM | Part No. | Qty Per Box | Mandrel Part No. |
|---------------|--------|-------|---------|--------|---------|----------|-------------|------------------|
| 1 x 1 x 3/16 | 821 | A/O | Hard | Medium | 30,000 | 77830 | 10 | 95240 |
| 3 x 1/2 x 1/4 | 821 | A/O | Hard | Medium | 18,000 | 77835 | 10 | 95002 |
| 3 x 1/4 x 1/4 | 524 | S/C | Soft | Medium | 18,000 | 77840 | 10 | 95002 |
| 3 x 1/4 x 1/4 | 532 | S/C | Soft | Fine | 18,000 | 77845 | 10 | 95002 |
| 3 x 1/4 x 1/4 | 632 | S/C | Medium | Fine | 18,000 | 77850 | 10 | 95002 |
| 3 x 1/4 x 1/4 | 731 | A/O | Medium | Fine | 18,000 | 77855 | 10 | 95002 |
| 3 x 1/4 x 1/4 | 811 | A/O | Hard | Coarse | 18,000 | 77860 | 10 | 95002 |
| 3 x 1/4 x 1/4 | 821 | A/O | Hard | Medium | 18,000 | 77865 | 10 | 95002 |



- Constructed by bonding and compressing layers of non-woven material
- Hot pressed to form a solid block from which wheels are cut



Bench Grinder

Deburring 8SF-Medium Density

- Excellent starting point for general purpose deburring, blending, and weld polishing
- Silicon carbide grain for fast cut rate and finest finish
- Comparable to competitive 8SF products

METAL Ferrous and non-ferrous materials

STAINLESS Aluminum, stainless steel, high tensile materials



Deburring 9SF-Hard Density

- Excellent for aggressive deburring, blending
- Silicon carbide grain for fast cut rate and finest finish
- Comparable to competitive 9SF products

METAL Ferrous and non-ferrous materials

STAINLESS Aluminum, stainless steel, high tensile materials

NOTE: Wheels must be run in the direction of the arrow as indicated on the wheel.

| Size | Spec. | Density | Grain | Grade | Max RPM | Part No. | Qty Per Box |
|-------------|-------|---------|-----------------|-------|---------|----------|-------------|
| 6 x 1/2 x 1 | 9SF | Hard | Silicon Carbide | Fine | 6,000 | 77810 | 4 |
| 6 x 1 x 1 | 8SF | Medium | Silicon Carbide | Fine | 6,000 | 77815 | 3 |
| 6 x 1 x 1 | 9SF | Hard | Silicon Carbide | Fine | 6,000 | 77820 | 3 |
| 8 x 1 x 3 | 9SF | Hard | Silicon Carbide | Fine | 4,500 | 77825 | 3 |



See page 148 for mounting flanges and reducing bushings



Tech
INFO

- Convolute wheels are constructed by wrapping non-woven nylon, impregnated with abrasive grains, around a hard core to form a homogenous wheel
- Dense, non-woven construction for long lasting wear and high edge durability
- Smooth running for less operator fatigue
- Non-metallic for no workpiece contamination
- Smear-resistant formulation to greatly reduce the possibility of smearing
- Provides best durability, stock removal, and finest finish for increased productivity

NON-WOVEN
ABRASIVES

NON-WOVEN



Disc Sander



Portable Grinder



Bench Grinder

Sand-Light™ Blending Discs

- For minor finishing and blending applications
- Less aggressive cutting than traditional surface conditioning discs (pg 119-120)
- Great for final finishing prior to buffing with compounds

STAINLESS Aluminum and stainless steel

METAL Ferrous and non-ferrous materials, plastics

Available in SAIT-LOK™, Hook and Loop, and arbor hole discs

Packaging

| | | |
|---------------|----|--------|
| SAIT-LOK™ | 2" | 50/box |
| | 3" | 25/box |
| Hook and Loop | | 10/box |
| Arbor Hole | | 10/box |



| Size | Grade | Arbor Hole Part No. | Qty Per Box |
|---------|-----------|---------------------|-------------|
| 6 x 1/2 | Medium | 77162 | 10 |
| | Very Fine | 77165 | 10 |
| 8 x 1/2 | Medium | 77182 | 10 |
| | Very Fine | 77185 | 10 |

Medium

- General purpose
- Excellent for light deburring, cleaning and polishing

STAINLESS Aluminum and stainless steel

METAL Ferrous and non-ferrous materials, plastics

Very Fine

- Excellent for blending and final finishing

STAINLESS Aluminum and stainless steel

METAL Ferrous and non-ferrous materials, plastics



| Size | Grade | SAIT-LOK™ Part No. | Qty Per Box |
|----------|-----------|--------------------|-------------|
| 2" Thick | Medium | 77672 | 50 |
| | Very Fine | 77675 | 50 |
| 3" Thick | Medium | 77682 | 25 |
| | Very Fine | 77685 | 25 |

| Size | Grade | Hook & Loop Part No. | Qty Per Box |
|----------|-----------|----------------------|-------------|
| 5" Thick | Medium | 77382 | 10 |
| | Very Fine | 77385 | 10 |
| 6" Thick | Medium | 77392 | 10 |
| | Very Fine | 77395 | 10 |



- Use the Medium grade for light finishing after using surface conditioning discs
- Use the Very Fine grade followed by the SAIT® Buffing Discs and compounds for a near mirror finish
- Use the slowest speed possible for optimum results

Buffing Discs

NON-WOVEN



Buffing Discs

- Premium quality buffing material
- Designed for final cosmetic finishing
- Available in hook and loop and SAIT-LOK-R™

STAINLESS Stainless steel and other high tensile alloys

METAL Aluminum, brass and other non-ferrous metals



| Size | SAIT-LOK-R™ Part No. | Hook & Loop Part No. | Qty Per Box |
|------|----------------------|----------------------|-------------|
| 2" | 41012 | - | 50 |
| 3" | 41013 | - | 25 |
| 5" | - | 41055 | 10 |
| 7" | - | 41057 | 10 |

See page 145 and 148 for backing pads

Compound Kit

The compound kit contains the following:

Brown Bar: Used for buffing aluminum, brass, copper, wood, plastics, hard rubber, and painted surfaces. Also called tripoli rouge.

White Bar: Used for buffing stainless steel, carbon steel, nickel, aluminum, and chromium to a high luster shine.

Red Bar: For buffing precious metals like gold, silver, platinum, sterling, and other high-end metals. Can also be used to further enhance materials that have already been buffed with other compounds. The finest grade.

Black Bar: Used to buff contaminants out prior to finishing. Will remove rust, stains, scale, and other contaminants. An extremely fast cutting material. Also called emery cake.

Individual bars are also available.



| Description | Part No. | Qty Per Box |
|----------------------|----------|-------------|
| Buffing Compound Kit | 41000 | 1 |
| Brown Bar | 41024 | 1 |
| White Bar | 41022 | 1 |
| Red Bar | 41020 | 1 |
| Black Bar | 41026 | 1 |

Tech INFO

- To achieve the best finish possible, use with the soft backing pads (part numbers 95255 & 95257) and the compound kit (part number 41000)
- In general, a slower speed achieves a better finish and reduces heat
- For use on right angle grinder, D/A (dual action) sanders, and right angle air grinders

WIRE BRUSHES INTRODUCTION



United Abrasives' brushes consist of only the highest grade industrial tempered wire and state-of-the-art construction, designed for off-hand equipment. The various styles cover a multitude of applications.



Features and Benefits

Brushes are available in a variety of wire types. The proper brush for the application should be selected based on the characteristics of the brush, including wire type. All BlueLine™ packaging is one piece per package.

Knot wire brushes provide high impact action and offer low to medium flexibility through the use of twisted wire tufts for heavy duty applications, such as weld cleaning. Knot wire brushes are available in 2 knot configurations.

Crimped wire brushes are general purpose brushes that provide higher flexibility and cleaning action through the use of flexible wire points. They offer a wider work face than knot style and are ideal for light applications such as rust or paint removal.



Flag at end of wire tuft provides additional brush flexibility for irregular surface preparation.



Extremely narrow tufted face is ideal for bead weld preparation.



Flexible wire points provide cleaning action for light applications.

Wire Size Specifications

The thickness of brush wire will impact the end result of the workpiece. Fine wire such as .008 will produce a finer finish and will yield a longer brush life. Thicker wires, such as .014 and .020 or higher, will be more aggressive and will decrease production times.

Brush Fill Materials

Carbon is a soft steel wire that can be used for lighter, general purpose brushing jobs. This is the most common wire brush material used.

Type 302 Stainless Steel Wire offers a long brush life and is resistant to corrosion. Type 302 stainless should be used when "after rust" or contamination is a problem such as on aluminum, stainless steel, or other high tensile alloys. "After rust" occurs when these alloys are brushed with other types of wire.



WIRE BRUSHES INTRODUCTION

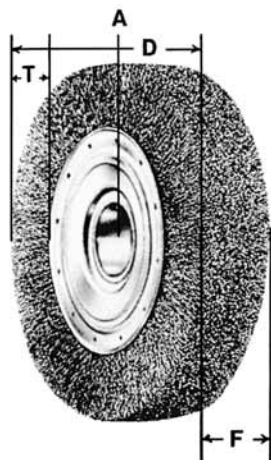

Common Brush Terminology

- A = Arbor Hole
- D = Brush Diameter
- F = Face Width
- T = Trim Length

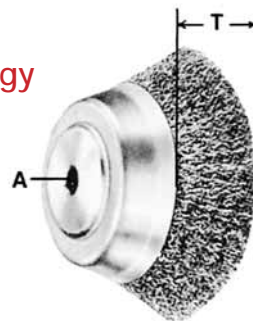

Application Information

- Always check warning labels for safety information
- Always follow safety guidelines included with each brush package
- Proper application of wire brushes is for the removal of various surface contaminants, not the removal of the base stock material
- The power tool determines the size and speed of the brush to be used
- Check the R.P.M. rating of the tool to verify that it does not exceed the Maximum Safe Free Speed (M.S.F.S.) of the brush
- The slowest speed that will do the job is the most efficient use of the brush. Running at the M.S.F.S. is not necessarily the most efficient speed
- The tool shaft must match the arbor hole of the brush
- The tips of wire at the end of the brush do the work. Excessive pressure will cause premature wire breakage, reduced brush life, increased heat build-up and rapid dulling

Power Brush Safety Requirements

1. **Safety Goggles:** Safety goggles, or full face shields worn over safety glasses with side shields, **MUST BE WORN** by all OPERATORS and OTHERS IN THE AREA OF POWER BRUSH OPERATIONS. Comply with the requirements of ANSI Z87.1 ("Occupational Eye and Face Protection").
2. **Guards:** Keep all machine guards in place.
3. **Speeds:** Observe all speed restrictions indicated on the brushes, containers, labels, or printed in pertinent literature. "MSFS" or "MAX.SFS" means Maximum Safe Free Speed (R.P.M.) - spinning free with no work applied. For reasons of safety, the "MSFS/MAX.SFS" should not be exceeded under any circumstances.
4. **Safety Standard:** Comply with the safety standards of the American National Standards Institute, ANSI B165.1 and ANSI B165.2 - "Safety Requirements - Power Brushes."
5. **Protective Equipment:** Appropriate protective clothing and equipment (such as full face shield, gloves, respirator, etc.) must be used where a possibility of injury exists that can be prevented by such equipment.
6. **Before starting brush:** Use eye protection and safety equipment. Inspect brush for rust, damage, speed limit, etc. If no-load speed marked on the power tool is higher than the brush speed limit, do not mount brush. Inspect and jog machine to assure the brush is mounted properly and securely, machine guards are in place, no vibration, etc. Run machine at operating speed for at least one minute before applying work. **DO NOT STAND IN FRONT OF OR IN LINE WITH BRUSH.**

All United Abrasives brushes comply with the standards of the American Brush Manufacturers' Association, the American National Standards Institute, and the Canadian Standard Association Safety Code.



Bench Grinder

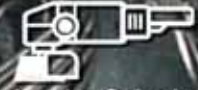

Angle Grinder

Bench Wire Wheels

- Dense, compact crimped steel wire brush face
- **May be stacked to achieve wider work face**
- Primary application: For general scale removal, cleaning and surface preparation
- Standard 2" arbor, with adaptor to listed arbor
- Includes bushing pairs to adapt to variety of arbors

Additional arbors available

| Part No. | Size |
|----------|-----------|
| 95201 | 2 x 1/2 |
| 95203 | 2 x 5/8 |
| 95204 | 2 x 3/4 |
| 95206 | 2 x 1 |
| 95207 | 2 x 1-1/4 |

**** not available for part number 09558 and 09555



| Size | | | Face Width | Trim Length | Max RPM | INDUSTRIAL | | BLUE LINE™ |
|------|------|----------|------------|-------------|---------|------------|---------|------------|
| Dia. | Wire | Arbor | | | | Part No. | Std Pkg | Part No. |
| 6 | .014 | 5/8, 1/2 | Wide | 1-1/16" | 6,000 | 09557 | 1 | 06557 |
| 6 | .014 | 5/8, 1/2 | Narrow | 1-3/16" | 6,000 | 09558**** | 1 | 06558 |
| 6 | .008 | 5/8, 1/2 | Narrow | 1-1/16" | 6,000 | 09555**** | 1 | 06555 |
| 7 | .014 | 5/8 | Wide | 1-9/16" | 6,000 | 09559 | 1 | 06559 |
| 8 | .014 | 5/8 | Wide | 1-1/2" | 4,000 | 01411 | 1 | 06556 |
| 10 | .014 | 3/4 | Wide | 2" | 3,600 | 09560 | 1 | - |

Note: Wide 1"
Narrow 1/2"

Packaging

Standard industrial packaging or Blue Line™ point of sale display packaging

Large Cup Brushes

- Available in the following wire types:
 - Knot wire for low to medium flexibility and aggressive cutting action
 - Crimped wire which has higher flexibility for light cleaning and removal, especially on irregular surfaces
- Primary application: For fast cleaning of large surfaces

Knot Wire - nut inside

| Size | | | Rows | Trim Length | Max RPM | INDUSTRIAL | | BLUE LINE™ |
|------|------|--------|------|-------------|---------|------------|---------|------------|
| Dia. | Wire | Arbor | | | | Part No. | Std Pkg | Part No. |
| 4 | .020 | 5/8-11 | 1 | 1-3/8" | 9,000 | 03407** | 1 | 06407 |
| 4 | .020 | 5/8-11 | 1 | Stainless* | 6,000 | 03406*** | 1 | 06406 |
| 6 | .020 | 5/8-11 | 1 | 1-3/4" | 6,600 | 03409*** | 1 | 06409 |
| 6 | .035 | 5/8-11 | 1 | 1-3/4" | 6,600 | 03410*** | 1 | 06410 |
| 6 | .020 | 5/8-11 | 2 | 1-3/4" | 6,000 | 03411*** | 1 | 06411 |
| 6 | .035 | 5/8-11 | 2 | 1-3/4" | 6,000 | 03412*** | 1 | 06412 |
| 6 | .020 | 5/8-11 | 1 | Stainless* | 6,600 | 03413*** | 1 | 06413 |

Crimped Wire - nut inside

| | | | | | | | | |
|---|------|--------|------------|--------|-------|-------|---|-------|
| 4 | .020 | 5/8-11 | - | 1-1/8" | 9,000 | 09551 | 1 | 06551 |
| 5 | .020 | 5/8-11 | - | 1-1/2" | 8,000 | 09552 | 1 | - |
| 5 | .020 | 5/8-11 | Stainless* | 1-1/2" | 8,000 | 09554 | 1 | 06554 |
| 6 | .020 | 5/8-11 | - | 1-1/2" | 6,600 | 09553 | 1 | 06553 |



Packaging

Standard industrial packaging or Blue Line™ point of sale display packaging

* 302 stainless steel wire used

** nut on outside

***nut on outside in Canada only

Small Cup



Angle Grinder

BRUSHES

Small Cup Brushes

- For use on small grinders
- Available in the following wire types:
 - Knot wire for low to medium flexibility and aggressive cutting action
 - Crimped carbon steel wire for light cleaning and where greater flexibility is required
 - Stainless steel knot wire for use on stainless, aluminum, and high strength alloys
- Variety of threaded arbors available

Packaging

Standard industrial packaging or Blue Line™ point of sale display packaging

*302 stainless steel wire used



| Size | | | Wire Style | Matl Type | Max RPM | INDUSTRIAL | | BLUE LINE™ |
|-------|------|------------|------------|------------|---------|------------|---------|------------|
| Dia. | Wire | Arbor | | | | Part No. | Std Pkg | Part No. |
| 2-3/4 | .014 | 5/8-11 | Knot | Carbon | 12,500 | 03414 | 6 | 06414 |
| 2-3/4 | .014 | M14 x 2.0 | Knot | Carbon | 12,500 | 03415 | 6 | 06415 |
| 2-3/4 | .014 | M10 x 1.25 | Knot | Carbon | 12,500 | 03416 | 6 | 06416 |
| 2-3/4 | .014 | M10 x 1.5 | Knot | Carbon | 12,500 | 03417 | 6 | 06417 |
| 2-3/4 | .014 | 1/2-13 | Knot | Carbon | 12,500 | 03418 | 6 | 06418 |
| 2-3/4 | .020 | 5/8-11 | Knot | Carbon | 12,500 | 03501 | 6 | 06501 |
| 2-3/4 | .020 | M14 x 2.0 | Knot | Carbon | 12,500 | 03502 | 6 | 06502 |
| 2-3/4 | .020 | M10 x 1.25 | Knot | Carbon | 12,500 | 03503 | 6 | 06503 |
| 2-3/4 | .020 | M10 x 1.5 | Knot | Carbon | 12,500 | 03504 | 6 | 06504 |
| 2-3/4 | .020 | 1/2-13 | Knot | Carbon | 12,500 | 03505 | 6 | 06505 |
| 2-3/4 | .014 | 5/8-11 | Knot | Stainless* | 12,500 | 03419 | 6 | 06419 |
| 2-3/4 | .014 | M14 x 2.0 | Knot | Stainless* | 12,500 | 03423 | 6 | 06423 |
| 2-3/4 | .014 | M10 x 1.25 | Knot | Stainless* | 12,500 | 03422 | 6 | 06422 |
| 2-3/4 | .014 | M10 x 1.5 | Knot | Stainless* | 12,500 | 03421 | 6 | 06421 |
| 2-3/4 | .014 | 1/2-13 | Knot | Stainless* | 12,500 | 03420 | 6 | 06420 |
| 2-3/4 | .020 | 5/8-11 | Knot | Stainless* | 12,500 | 03506 | 6 | 06506 |
| 2-3/4 | .020 | M14 x 2.0 | Knot | Stainless* | 12,500 | 03507 | 6 | 06507 |
| 2-3/4 | .020 | M10 x 1.25 | Knot | Stainless* | 12,500 | 03508 | 6 | 06508 |
| 2-3/4 | .020 | M10 x 1.5 | Knot | Stainless* | 12,500 | 03509 | 6 | 06509 |
| 2-3/4 | .020 | 1/2-13 | Knot | Stainless* | 12,500 | 03510 | 6 | 06510 |
| 2-3/4 | .014 | 5/8-11 | Crimped | Carbon | 12,500 | 01401 | 6 | 06401 |
| 2-3/4 | .014 | M14 x 2.0 | Crimped | Carbon | 12,500 | 01405 | 6 | 06405 |
| 2-3/4 | .014 | M10 x 1.25 | Crimped | Carbon | 12,500 | 01404 | 6 | 06404 |
| 2-3/4 | .014 | M10 x 1.5 | Crimped | Carbon | 12,500 | 01403 | 6 | 06403 |
| 2-3/4 | .014 | 1/2-13 | Crimped | Carbon | 12,500 | 01402 | 6 | 06402 |
| 2-3/4 | .014 | 5/8-11 | Crimped | Stainless* | 12,500 | 01408 | 6 | 06408 |
| 3-1/2 | .020 | 5/8-11 | Knot | Carbon | 12,500 | 03511 | 1 | 06511 |
| 3-1/2 | .020 | 5/8-11 | Knot | Stainless* | 12,500 | 03512 | 1 | 06512 |
| 3-1/2 | .014 | 5/8-11 | Crimped | Carbon | 12,500 | 03513 | 1 | 06513 |
| 3-1/2 | .014 | 5/8-11 | Crimped | Stainless* | 12,500 | 03514 | 1 | 06514 |

WIRE BRUSHES

BRUSHES



Angle Grinder



Knot & Crimped Wire Wheels

- For use on small grinders
- Available in the following wire types:
 - Regular twist covers more surface area in a single pass
 - Stringer bead twist excellent for welds, flux removal and where a narrow work face is required
 - Crimped carbon steel wire provides flexibility and a wider work face than knot style
 - Stainless steel wire for use on stainless, aluminum, and high strength alloys
- Variety of threaded arbors available

Packaging

Standard industrial packaging or Blue Line™ point of sale display packaging

Regular Twist

*302 stainless steel wire used

| Size | | | Matl Type | Max RPM | INDUSTRIAL | | BLUE LINE™ |
|------|------|------------|------------|---------|------------|---------|------------|
| Dia. | Wire | Arbor | | | Part No. | Std Pkg | Part No. |
| 4 | .014 | 5/8-11 | Carbon | 20,000 | 03426 | 6 | 06426 |
| 4 | .014 | M14 x 2.0 | Carbon | 20,000 | 03427 | 6 | 06427 |
| 4 | .014 | M10 x 1.25 | Carbon | 20,000 | 03428 | 6 | 06428 |
| 4 | .014 | M10 x 1.5 | Carbon | 20,000 | 03429 | 6 | 06429 |
| 4 | .014 | 1/2-13 | Carbon | 20,000 | 03430 | 6 | 06430 |
| 4 | .020 | 5/8-11 | Carbon | 20,000 | 03460 | 6 | 06460 |
| 4 | .014 | 5/8-11 | Stainless* | 20,000 | 03431 | 6 | 06431 |
| 4 | .014 | M14 x 2.0 | Stainless* | 20,000 | 03435 | 6 | 06435 |
| 4 | .014 | M10 x 1.25 | Stainless* | 20,000 | 03434 | 6 | 06434 |
| 4 | .014 | M10 x 1.5 | Stainless* | 20,000 | 03433 | 6 | 06433 |
| 4 | .014 | 1/2-13 | Stainless* | 20,000 | 03432 | 6 | 06432 |
| 4 | .020 | 5/8-11 | Stainless* | 20,000 | 03461 | 6 | 06461 |
| 6 | .025 | 5/8-11 | Carbon | 9,000 | 03385 | 6 | 06385 |

Stringer Bead / Pipeline

| | | | | | | | |
|-------|------|------------|---------------|--------|-------|---|-------|
| 4 | .020 | 5/8-11 | Carbon | 20,000 | 03440 | 6 | 06440 |
| 4 | .020 | M14 x 2.0 | Carbon | 20,000 | 03441 | 6 | 06441 |
| 4 | .020 | M10 x 1.25 | Carbon | 20,000 | 03442 | 6 | 06442 |
| 4 | .020 | M10 x 1.5 | Carbon | 20,000 | 03443 | 6 | 06443 |
| 4 | .020 | 1/2-13 | Carbon | 20,000 | 03444 | 6 | 06444 |
| 4 | .020 | 5/8-11 | Stainless* | 20,000 | 03445 | 6 | 06445 |
| 4 | .020 | M14 x 2.0 | Stainless* | 20,000 | 03446 | 6 | 06446 |
| 4 | .020 | M10 x 1.25 | Stainless* | 20,000 | 03447 | 6 | 06447 |
| 4 | .020 | M10 x 1.5 | Stainless* | 20,000 | 03448 | 6 | 06448 |
| 4 | .020 | 1/2-13 | Stainless* | 20,000 | 03449 | 6 | 06449 |
| 5 | .020 | 5/8-11 | SB-Carbon | 12,000 | 03380 | 6 | 06380 |
| 5 | .020 | M14 x 2.0 | Carbon | 12,000 | 03381 | 6 | 06381 |
| 5 | .020 | 5/8-11 | SB-Stainless* | 12,000 | 03382 | 6 | 06382 |
| 6 | .020 | 5/8-11 | SB-Stainless* | 12,000 | 03383 | 6 | 06383 |
| 6 | .020 | 5/8-11 | SB-Carbon | 12,000 | 03384 | 6 | 06384 |
| 6-1/2 | .020 | 5/8-11 | SB-Stainless* | 9,000 | 03389 | 6 | 06389 |
| 6-1/2 | .020 | 5/8-11 | SB-Carbon | 9,000 | 03391 | 6 | 06391 |

Crimped

| | | | | | | | |
|---|------|------------|--------|--------|-------|---|-------|
| 4 | .014 | 5/8-11 | Carbon | 12,500 | 03450 | 6 | 06450 |
| 4 | .014 | M14 x 2.0 | Carbon | 12,500 | 03451 | 6 | 06451 |
| 4 | .014 | M10 x 1.25 | Carbon | 12,500 | 03452 | 6 | 06452 |
| 4 | .014 | M10 x 1.5 | Carbon | 12,500 | 03453 | 6 | 06453 |
| 4 | .014 | 1/2-13 | Carbon | 12,500 | 03454 | 6 | 06454 |



Angle Grinder



Packaging

Standard industrial packaging or Blue Line™ point of sale display packaging

*302 stainless steel wire used

Knot Wire Wheels

- Can be used on portable power tools
- Available in the following wire types:
 - Knot wire for low to medium flexibility and aggressive cutting action
 - Stainless steel wire for use on stainless, aluminum, and high strength alloys
- Primary application: **Cleaning, deburring, and scale removal**

| Size | | | Matl Type | Max RPM | INDUSTRIAL | | BLUE LINE™ |
|------|------|----------|------------|---------|------------|---------|------------|
| Dia. | Wire | Arbor | | | Part No. | Std Pkg | Part No. |
| 3 | .014 | 3/8 | Carbon | 25,000 | 03377 | 4 | 06377 |
| 3 | .014 | 1/2, 3/8 | Stainless* | 25,000 | 03376 | 4 | 06376 |
| 4 | .014 | 1/2 | Carbon | 20,000 | 03378 | 4 | 06378 |
| 5 | .020 | 5/8-11 | Carbon | 9,000 | 03373 | 1 | 06373 |
| 5 | .020 | 5/8-11 | Stainless* | 12,000 | 03374 | 1 | 06374 |
| 6 | .020 | 5/8, 1/2 | Carbon | 9,000 | 03386 | 1 | 06386 |
| 6 | .020 | 5/8-11 | Carbon | 9,000 | 03388 | 1 | 06388 |
| 6 | .016 | 5/8, 1/2 | Stainless* | 9,000 | 03387 | 1 | 06387 |



Packaging

Standard industrial packaging or Blue Line™ point of sale display packaging

*302 stainless steel wire used

Pipeline Brushes

- Excellent for use in the pipeline industry
- Available in the following wire types:
 - Knot wire provides aggressive action in the removal of bead scale, weld flash, or splatter
 - Regular twist and stringer bead twist for higher impact action
 - Stainless steel wire available in stringer bead twist for use on stainless, aluminum, and high strength alloys
- Primary application: **Cleaning, deburring, and scale removal**

| Size | | | Matl Type | Max RPM | INDUSTRIAL | | BLUE LINE™ |
|-------|------|------------|---------------|---------|------------|---------|------------|
| Dia. | Wire | Arbor | | | Part No. | Std Pkg | Part No. |
| 4 | .020 | 5/8-11 | Carbon | 20,000 | 03440 | 6 | 06440 |
| 4 | .020 | M14 x 2.0 | Carbon | 20,000 | 03441 | 6 | 06441 |
| 4 | .020 | M10 x 1.25 | Carbon | 20,000 | 03442 | 6 | 06442 |
| 4 | .020 | M10 x 1.5 | Carbon | 20,000 | 03443 | 6 | 06443 |
| 4 | .020 | 1/2-13 | Carbon | 20,000 | 03444 | 6 | 06444 |
| 4 | .020 | 5/8-11 | Stainless* | 20,000 | 03445 | 6 | 06445 |
| 4 | .020 | M14 x 2.0 | Stainless* | 20,000 | 03446 | 6 | 06446 |
| 4 | .020 | M10 x 1.25 | Stainless* | 20,000 | 03447 | 6 | 06447 |
| 4 | .020 | M10 x 1.5 | Stainless* | 20,000 | 03448 | 6 | 06448 |
| 4 | .020 | 1/2-13 | Stainless* | 20,000 | 03449 | 6 | 06449 |
| 5 | .020 | 5/8-11 | SB-Carbon | 12,000 | 03380 | 6 | 06380 |
| 5 | .020 | M14 x 2.0 | Carbon | 12,000 | 03381 | 6 | 06381 |
| 5 | .020 | 5/8-11 | SB-Stainless* | 12,000 | 03382 | 6 | 06382 |
| 6 | .020 | 5/8-11 | SB-Stainless* | 12,000 | 03383 | 6 | 06383 |
| 6 | .020 | 5/8-11 | SB-Carbon | 12,000 | 03384 | 6 | 06384 |
| 6 | .025 | 5/8-11 | Carbon | 9,000 | 03385 | 6 | 06385 |
| 6-1/2 | 020 | 5/8-11 | SB-Stainless* | 9,000 | 03389 | 6 | 06389 |
| 6-1/2 | 020 | 5/8-11 | SB-Carbon | 9,000 | 03391 | 6 | 06391 |

WIRE BRUSHES

BRUSHES

BRUSHES

Joint/End Brushes



Die Grinder



Street Saw



Joint Brushes

- For use on street saws
- Primary application: Cleaning concrete expansion joints

Packaging

1 brush per package

| Dia. | Wire Size | Description | Max RPM | Part No. | Std Pkg |
|------|-----------|------------------------------------|---------|----------|---------|
| 12" | .035 | Joint Brush 1" Arbor, 7/16 Pinhole | 6,000 | 09570 | 1 |

End Brushes

- For use on portable power tools
- Excellent for use in cleaning and finishing recessed areas or pipes
- Available in the following wire types:
 - Knot wire provides aggressive cutting action
 - Circular flared end brush excellent for side cleaning action
 - Crimped wire for high flexibility
- 1/4" shank diameter

Packaging

Standard industrial packaging or Blue Line™ point of sale display packaging

*302 stainless steel wire used



| Size Dia. | Wire Wire | Wire Style | Trim Length | Overall Length | Max RPM | INDUSTRIAL | | BLUE LINE™ |
|--------------|--------------|-----------------------|----------------|-------------------|------------|-------------|------------|-------------|
| | | | | | | Part No. | Std Pkg | Part No. |
| 1 | .020 | Knot Type | 1 | 2-5/8 | 22,000 | 02701 | 12 | 06701 |
| 1 | .020 | Crimped Wire | 1 | 2-5/8 | 22,000 | 02709 | 12 | 06709 |
| 1 | .020 | SS-Knot* | 1 | 2-5/8 | 22,000 | 02704 | 12 | 06704 |
| 3/4 | .014 | Crimped Wire | 1 | 2-5/8 | 22,000 | 02702 | 12 | 06702 |
| 3/4 | .014 | Knot Type | 1-1/8 | 2-5/8 | 22,000 | 02703 | 12 | 06703 |
| 1-1/2 | .012 | Circ. Flared Crimped | 5/16 | 1-3/4 | 20,000 | 02710 | 12 | 06710 |
| 2-1/2 | .014 | Circ. Flared | 11/16 | 1-3/4 | 20,000 | 02705 | 12 | 06705 |
| 2 | .014 | Crimped Wire Wheel | 7/16 | 1-1/4 | 25,000 | 02712 | 12 | 06712 |
| 3 | .014 | Circ. Flared Crimped* | 7/8 | 1-3/4 | 20,000 | 02711 | 12 | 06711 |
| 3 | .014 | Crimped Wire Wheel | 15/16 | 1-1/4 | 25,000 | 02713 | 12 | 06713 |
| 3 | .014 | Crimped Wire Wheel* | 15/16 | 1-1/4 | 25,000 | 02714 | 12 | 06714 |

WIRE
BRUSHES

BRUSHES

Scratch/Miscellaneous

BRUSHES



Scratch Brushes

- Excellent for light scale removal
- Available in the following wire types:
 - Carbon steel wire for general purpose cleaning
 - Stainless steel wire is carbon free
 - Brass wire for general purpose cleaning
- Primary application: Maintenance cleaning

*302 stainless steel wire used

| Size Rows | Wire Size | Type | Part No. | Std Pkg |
|-----------|-----------|--|----------|---------|
| 3 x 19 | .014 | Curved Handle | 05751 | 12 |
| 3 x 19 | .014 | Curved Handle w/Scraper | 05760 | 12 |
| 3 x 19 | .012 | Curved-Stainless* | 05755 | 12 |
| 3 x 14 | .014 | V-Groove Scratch | 05764 | 12 |
| 3 x 14 | .012 | V-Groove Scratch-Stainless* | 05765 | 12 |
| 4 x 16 | .014 | Shoe Handle | 05753 | 12 |
| 4 x 16 | .014 | Shoe Handle w/Scraper | 05761 | 12 |
| 4 x 16 | .012 | Shoe Handle-Stainless* | 05763 | 12 |
| 4 x 19 | .014 | Curved Handle | 05752 | 12 |
| 3 x 7 | .006 | Small Cleaning Brush-Stainless* | 05759 | 12 |
| 3 x 7 | .006 | Small Cleaning Brush w/Plastic Handle-Stainless* | 05766 | 12 |
| 3 x 7 | .006 | Small Cleaning Brush-Brass | 05762 | 12 |
| 3 x 7 | .006 | Small Cleaning Brush w/Plastic Handle-Brass | 05768 | 12 |
| 3 x 15 | - | Chipping Hammer Brush | 05757 | 12 |

Miscellaneous Brushes

Metal Chip Brush

- Durable, long lasting
- For cleaning metal chips from work surfaces

Acid Brushes

- Quality horsehair bristles
- Machine trimmed and crimped to specification

Paint Brushes

- Quality horsehair bristles/Wood handle
- Use for solvents and chemicals



| Brush Type | Width | Trim Length | Overall Length | Part No. | Std Pkg |
|-------------|--------|-------------|----------------|----------|---------|
| Metal Chip | 1-1/2" | 1-1/2" | 5-5/16" | 00510 | 12 pcs |
| | 3/8" | 3/4" | 6" | 00501 | 1 gross |
| Acid Brush | 7/16" | 3/16" | 6-1/2" | 00502 | 1 gross |
| | 9/16" | 7/8" | 6-1/8" | 00503 | 1 gross |
| Paint Brush | 1/2" | 1-1/2" | 7" | 00511 | 72 pcs |
| | 1" | 1-1/2" | 7-1/2" | 00512 | 72 pcs |
| | 1-1/2" | 1-1/2" | 7-1/2" | 00513 | 72 pcs |
| Paint Brush | 2" | 1-1/2" | 7-1/2" | 00514 | 72 pcs |
| | 3" | 1-1/2" | 8" | 00515 | 48 pcs |
| | 4" | 2-1/4" | 9-1/2" | 00516 | 12 pcs |

WIRE BRUSHES

BRUSHES

BRUSHES

Nylon



Hand Brush



Die Grinder



Bench Grinder

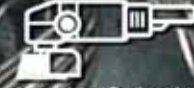

Angle Grinder

Nylon Abrasive Brushes

- Available in silicon carbide
- Use on steel, aluminum, copper, brass, stainless steel, super alloys, plastics, composites, ceramics, wood, leather



Large Diameter Wheels

| Size | | Grit | Face Width | Trim Length | Max RPM | Part No. | Qty Per Box |
|------|-------|------|------------|-------------|---------|----------|-------------|
| Dia. | Arbor | | | | | | |
| 3 | 5/8 | 80 | 1/2 | 5/8 | 18,000 | 04110 | 1 |
| 3 | 5/8 | 320 | 1/2 | 5/8 | 18,000 | 04120 | 1 |
| 4 | 5/8 | 120 | 5/8 | 3/4 | 12,000 | 04130 | 1 |
| 4 | 5/8 | 180 | 5/8 | 3/4 | 12,000 | 04140 | 1 |
| 6 | 2 | 120 | 7/8 | 1-1/16 | 6,000 | 04150 | 1 |
| 6 | 2 | 180 | 7/8 | 1-1/16 | 6,000 | 04160 | 1 |

Small Diameter Wheels

| Size | | Grit | Face Width | Trim Length | Max RPM | Part No. | Qty Per Box |
|-------|-------|------|------------|-------------|---------|----------|-------------|
| Dia. | Arbor | | | | | | |
| 1-1/2 | 1/2 | 320 | 1/4 | 1/4 | 20,000 | 04210 | 4 |
| 2 | 5/8 | 120 | 3/8 | 7/16 | 15,000 | 04220 | 4 |
| 2-1/2 | 5/8 | 120 | 3/8 | 11/16 | 15,000 | 04230 | 4 |
| 2-1/2 | 5/8 | 320 | 3/8 | 11/16 | 15,000 | 04240 | 4 |

Cup Brushes

| Size | | Grit | Trim Length | Max RPM | Part No. | Qty Per Box |
|------|--------|------|-------------|---------|----------|-------------|
| Dia. | Arbor | | | | | |
| 4 | 5/8-11 | 80 | 1-1/2 | 6,000 | 04310 | 1 |
| 6 | 5/8-11 | 80 | 1-1/2 | 6,000 | 04340 | 1 |

End Brushes

| Dia. | Grit | Trim Length | Overall Length | Max RPM | Part No. | Qty Per Box |
|------|------|-------------|----------------|---------|----------|-------------|
| 1 | 120 | 1 | 2-3/4 | 19,000 | 04380 | 12 |
| 1 | 80 | 1 | 2-3/4 | 9,000 | 04390 | 6 |

Tube Brushes

| Dia. | Grit | Trim Length | Overall Length | Part No. | Qty Per Box |
|-------|------|-------------|----------------|----------|-------------|
| 1/2 | 80 | 2 | 5 | 04270 | 12 |
| 1 | 80 | 2-1/2 | 5-1/2 | 04275 | 12 |
| 1-1/4 | 80 | 2-1/2 | 5-1/2 | 04280 | 12 |
| 5/8 | 120 | 2 | 5 | 04285 | 12 |
| 1 | 120 | 2-1/2 | 5-1/2 | 04290 | 12 |

WIRE
BRUSHES

BRUSHES



Die Grinder

BURS

Tungsten Carbide Burs

United Abrasives offers a complete line of tungsten carbide burs in the most popular shapes and sizes to meet your needs. Choosing the right bur depends on the material to be ground, grinding speed, desired shape and finish requirements. United Abrasives' burs are precision ground with diamond wheels resulting in a concentric tool with very sharp, uniform teeth. This manufacturing method produces the highest quality bur, properly balanced for vibration-free operation and long tool life. Tungsten burs are best suited for efficient material removal at high RPMs. United Abrasives' burs are made in the U.S.A.

Double Cut (Alternate Cut)



Double cut or Alternate cut is the most popular bur in ferrous applications. Manufactured with cuts made on the left and right spirals, this design produces a finer finish on material producing smaller chips and slivers. The double cut offers much smoother operation and greater tool control.

Non-Ferrous (Aluminum Cut)



Non-ferrous or aluminum cut burs have a more open, aggressive cut to avoid loading on softer materials. This design provides outstanding stock removal on aluminum, magnesium, copper, soft steel, brass, zinc alloys, hard rubber, most plastics, and non-ferrous metals. These burs provide easy chip flow with little or no clogging.



Features

- Tungsten Carbide construction for long life and precision cutting
- Highest quality construction for proper balance which delivers vibration-free operation
- Double cut provides smooth operation and maximum tool control
- Non-ferrous burs have an open design for non-loading on softer materials

Applications

- Excellent for confined or hard-to-reach areas
- Use for deburring and finishing on ferrous and non-ferrous metals
- Shaping and enlarging holes in steel
- Removing welds
- Smoothing castings

MAXIMUM RECOMMENDED RPMs FOR CARBIDE BURS

| FILE DIA. | RPM(1) | RPM(2) |
|-----------|--------|--------|
| 1/4" | 22,000 | 33,000 |
| 3/8" | 18,000 | 27,000 |
| 1/2" | 16,000 | 24,000 |

Use RPM(1) for iron, steel welds, cast iron, tool steels, die steels, bronze, brass and aluminum.

Use RPM(2) for stainless steel.

CARBIDE
BURS

BURS

BURS

Tungsten Carbide Burs



Die Grinder

SB
(End Cut)



SH



SA



SC



SD



SE



SF



SG



SL



SM



Wooden Display Case
Holds up to 8 burs
P/N 99046

Heavy Duty

Double Cut (Alternate Cut)

| Type | Size | | Shank Dia. | Part Numbers | Qty Per Box |
|-----------------------------------|------|--------|---------------|-----------------|----------------|
| | Dia. | Length | | | |
| SA1 | 1/4 | 5/8 | 1/4 | 45000 | 1 |
| SA3 | 3/8 | 3/4 | 1/4 | 45001 | 1 |
| SA5 | 1/2 | 1 | 1/4 | 45002 | 1 |
| SB1 | 1/4 | 5/8 | 1/4 | 45111 | 1 |
| SB3 | 3/8 | 3/4 | 1/4 | 45004 | 1 |
| SB5 | 1/2 | 1 | 1/4 | 45113 | 1 |
| SC1 | 1/4 | 5/8 | 1/4 | 45005 | 1 |
| SC3 | 3/8 | 3/4 | 1/4 | 45006 | 1 |
| SC5 | 1/2 | 1 | 1/4 | 45007 | 1 |
| SD1 | 1/4 | 7/32 | 1/4 | 45010 | 1 |
| SD3 | 3/8 | 5/16 | 1/4 | 45011 | 1 |
| SD5 | 1/2 | 7/16 | 1/4 | 45012 | 1 |
| SE1 | 1/4 | 3/8 | 1/4 | 45015 | 1 |
| SE5 | 1/2 | 7/8 | 1/4 | 45016 | 1 |
| SF1 | 1/4 | 5/8 | 1/4 | 45020 | 1 |
| SF3 | 3/8 | 3/4 | 1/4 | 45021 | 1 |
| SF5 | 1/2 | 1 | 1/4 | 45022 | 1 |
| SH1 | 1/4 | 5/8 | 1/4 | 45115 | 1 |
| SH2 | 5/16 | 3/4 | 1/4 | 45116 | 1 |
| SH5 | 1/2 | 1-1/4 | 1/4 | 45117 | 1 |
| SL1 | 1/4 | 5/8 | 1/4 | 45025 | 1 |
| SL3 | 3/8 | 1-3/16 | 1/4 | 45026 | 1 |
| SL4 | 1/2 | 1-1/4 | 1/4 | 45027 | 1 |
| SG1 | 1/4 | 5/8 | 1/4 | 45030 | 1 |
| SG3 | 3/8 | 3/4 | 1/4 | 45031 | 1 |
| SG5 | 1/2 | 1 | 1/4 | 45032 | 1 |
| SM1 | 1/4 | 1/2 | 1/4 | 45035 | 1 |
| SM2 | 1/4 | 3/4 | 1/4 | 45036 | 1 |
| SM4 | 3/8 | 3/4 | 1/4 | 45037 | 1 |
| SM5 | 1/2 | 1 | 1/4 | 45038 | 1 |
| <hr/> | | | | | |
| Non-ferrous (Aluminum) | | | | | |
| SA3NF | 3/8 | 3/4 | 1/4 | 45050 | 1 |
| SA5NF | 1/2 | 1 | 1/4 | 45051 | 1 |
| SC3NF | 3/8 | 3/4 | 1/4 | 45052 | 1 |
| SF3NF | 3/8 | 3/4 | 1/4 | 45053 | 1 |
| SF5NF | 1/2 | 1 | 1/4 | 45054 | 1 |
| SL4NF | 1/2 | 1-1/8 | 1/4 | 45055 | 1 |

| Type | Size | | Shank Dia. | Part Numbers | Qty/ Box |
|------|------|--------|---------------|-----------------|-------------|
| | Dia. | Length | | | |
| SA5 | 1/2 | 1 | 1/4 | 45125 | 1 |
| SC5 | 1/2 | 1 | 1/4 | 45130 | 1 |
| SE5 | 1/2 | 7/8 | 1/4 | 45135 | 1 |
| SF3 | 3/8 | 3/4 | 1/4 | 45140 | 1 |
| SF5 | 1/2 | 1 | 1/4 | 45145 | 1 |
| SG5 | 1/2 | 1 | 1/4 | 45150 | 1 |
| SL3 | 3/8 | 1-3/16 | 1/4 | 45155 | 1 |
| SL4 | 1/2 | 1-1/4 | 1/4 | 45160 | 1 |

6" Length Shank

| Type | Size | | Shank Dia. | Part Numbers | Qty/ Box |
|---------|------|--------|---------------|-----------------|-------------|
| | Dia. | Length | | | |
| SA3L6 | 3/8 | 3/4 | 1/4 6L | 45603 | 1 |
| SA5L6 | 1/2 | 1 | 6L | 45605 | 1 |
| SB1L6 | 1/4 | 5/8 | 6L | 45611 | 1 |
| SB3L6 | 3/8 | 3/4 | 6L | 45613 | 1 |
| SC3L6 | 3/8 | 3/4 | 6L | 45623 | 1 |
| SD1L6 | 1/4 | 7/32 | 6L | 45631 | 1 |
| SD3L6 | 3/8 | 5/16 | 6L | 45633 | 1 |
| SE5L6 | 1/2 | 7/8 | 6L | 45645 | 1 |
| SF3L6 | 3/8 | 3/4 | 6L | 45653 | 1 |
| SF5L6 | 1/2 | 1 | 6L | 45655 | 1 |
| SG3L6 | 3/8 | 3/4 | 6L | 45663 | 1 |
| SG5L6 | 1/2 | 1 | 6L | 45665 | 1 |
| SH2L6 | 5/16 | 3/4 | 6L | 45672 | 1 |
| SL3L6 | 3/8 | 1-1/16 | 6L | 45683 | 1 |
| SM3L6 | 1/4 | 1 | 6L | 45693 | 1 |
| <hr/> | | | | | |
| SC3NFL6 | 3/8 | 3/4 | 6L | 45063 | 1 |
| SF3NFL6 | 3/8 | 3/4 | 6L | 45073 | 1 |
| SD3NFL6 | 3/8 | 5/16 | 6L | 45083 | 1 |



- Tungsten carbide construction for long life and durability
- High quality manufacturing method delivers vibration-free operation
- Precision ground with diamond wheels to produce a very sharp uniform cutting edge
- Each enclosed in individual plastic capsules for storage and protection

CARBIDE
BURS

BURS

SAIT-PAK™

✔ Packaged for industrial, hardware, and do-it-yourself markets

We are pleased to include our line of packaged abrasives called SAIT-PAK™. This offers our same industrial quality abrasives, packaged in smaller, easy-to-sell quantities. It complements our existing product line by providing a "line" specifically geared to those customers desiring more consumer-oriented packaging. Skilled craftsmen, professional tradesmen, MRO engineers, fabricators, and the knowledgeable do-it-yourselfer will benefit by this addition to our product line.

✔ United Abrasives makes selecting the correct products and quantities easy

Choosing the correct product for your application is made simple. The packaging contains the same easy-to-use color coded application boxes as our catalog. To meet all of your application needs, SAIT-PAK™ offers products in multi or single packs. Your local distributor has access to United Abrasives' entire SAIT-PAK™ line, offering you the products you want in the quantities you need.



✔ Our foundation is the mid-size independent distributor

United Abrasives has always relied on the small to mid-size independent distributor as our foundation, not the large national chains. As a result, this means that you will continue to receive the attention you deserve with United Abrasives' SAIT-PAK™ program.

✔ We manufacture only a single line of the highest quality

United Abrasives manufactures only a single line of the highest quality industrial abrasives, not a two-tier system of industrial versus retail quality. The SAIT-PAK™ program represents our same high quality products packaged specifically for retail trade.

✔ We're a "one stop shopping" source for all your abrasive product needs

It's easy to buy from United Abrasives. Quality and safety are of utmost importance, minimizing your product performance worries. UA is truly a "one stop shopping" source! Your account will be serviced by the best trained customer service reps and sales force in the industry.

✔ For more information call us at (860) 456-7131

This SAIT-PAK™ program allows you to move up to a level of industrial quality abrasive products at the retail packaged level. You'll get a full spectrum abrasives program with minimal inventory investments. The result is increased inventory turns, expanded market share, and excellent profit margins. For more information about how United Abrasives can help get you to the next level, contact us at (860) 456-7131.

SAIT-PAK™ 9" x 11" Sheets

All Purpose Aluminum Oxide Sheets

| Part No | Grade/Grit | Sheets Per Pkg | Pkgs Per Unit |
|---------|---|----------------|---------------|
| 10012 | Very Fine - 220 | 5 | 5 |
| 10010 | Fine - 150 | 5 | 5 |
| 10008 | Medium - 100 | 5 | 5 |
| 10006 | Coarse - 60 | 3 | 5 |
| 10015 | Assorted: 2 Very Fine, 2 Fine, 1 Medium | 5 | 5 |

Waterproof Silicon Carbide Sheets

| | | | |
|-------|---|---|---|
| 10034 | Ultra Fine - 600 | 5 | 5 |
| 10032 | Super Fine - 400 | 5 | 5 |
| 10031 | Extra Fine - 320 | 5 | 5 |
| 10028 | Very Fine - 220 | 5 | 5 |
| 10036 | Assorted: 2 Super Fine, 2 Extra Fine, 1 Very Fine | 5 | 5 |

SAIT-PAK™ Accessories

Hand Sanding Block

| Part No | Description | Parts Per Pkg |
|---------|--------------------|---------------|
| 16000 | Hand Sanding Block | 1 |

Accessory Items

The convenience of "one stop shopping" is provided through the selection of accessories offered by United Abrasives to complement and match our product offering.

All of the accessories carried in our line have been specifically engineered for use with our products, providing the greatest possible safety and performance. You will find that our SAIT-PAK™ product line of packaging geared for the Do-It-Yourself market includes accessory items specific to those products available in the line. However, should you need additional products that may not be available as part of the SAIT-PAK™ program, refer to our standard line of accessories in this section. Many of our accessory items are skin packaged, providing better labeling capabilities and appearance.

Throughout the catalog, references are made to the various accessories in this section. As part of the product selection, it is important to ascertain if a specific accessory is necessary to operate the abrasive safely. In most cases, where a nut or backing pad is required, one is supplied with the box of product. However, if additional accessory items are needed, they are available in this section. Thus, whether you are ordering in large quantities or individually, sufficient accessories are available for your needs.



Backing Pads for Resin Fiber Discs



- Spiralcool™ backing pads' exclusive rubber, fabric, and fiber board construction provide extra strength and reliability
- Spiral ribs provide contact points and form channels for air flow extending disc life 30% to 50%
- Each pad is supplied with a nut as indicated
- For the 10mm arbor pad specify nut:
#95044 for 1.5 nut or #95043 for 1.25 nut

NOTES: Pad nut must be purchased separately. This backing pad is not to be used with SAIT-LOK™ quick change fiber discs

| Size | Arbor | Grade Available | | | Max RPM |
|---------|---------------|-----------------|-------|-------|---------|
| | | Soft | Med | Hard | |
| 4 | 5/8-11 Thread | - | 95010 | - | 12,000 |
| * 4-1/2 | 5/8 | - | 95011 | - | 11,000 |
| 4-1/2 | 1/2 | - | 95012 | - | 11,000 |
| 4-1/2 | 10mm | - | 95013 | - | 11,000 |
| 4-1/2 | 14mm | - | 95015 | - | 11,000 |
| 5 | 5/8 | - | 95016 | - | 10,000 |
| 7 | 5/8-11 Thread | 95017 | - | - | 7,000 |
| 7 | 5/8-11 Thread | - | 95018 | 95019 | 8,500 |
| 9 | 5/8-11 Thread | 95020 | 95021 | 95022 | 6,500 |

* #95011 also for use on SAITBLEND™ discs

Spanner Wrench



- Adjustable wrench for tightening and loosening center nuts
- Fits all center nuts

| Description | Part No |
|----------------|---------|
| Spanner Wrench | 95008 |

SAIT-LOK™ Backing Pads for Resin Fiber Discs



- Smooth face backing pad for SAIT-LOK™ fiber disc
- Minimizes change-over downtime
- No additional mounting hardware required
- Each pad is supplied with nut and washers

NOTE: SAIT-LOK™ disc must be used with threaded backing pad

| Size | Part No | Max RPM |
|-----------------|---------|---------|
| *4-1/2 x 5/8-11 | 95023 | 18,000 |
| 4-1/2 x 5/8-11 | 95025 | 18,000 |
| *5 x 5/8-11 | 95024 | 18,000 |
| 5 x 5/8-11 | 95026 | 18,000 |
| 7 x 5/8-11 | 95027 | 8,600 |
| 9 x 5/8-11 | 95028 | 7,000 |

* Low profile for short spindles

Challenger II™ Backing Pad



- For use with Challenger II flexible grinding/blending wheels (pg. 18)
- Set includes 5/8-11 nut and pad

| Description | Part No | Max RPM |
|-----------------------------------|---------|---------------|
| Pad for 4-1/2 & 5" Challenger II™ | 95245 | 13,300/12,200 |
| Pad for 7" Challenger II™ | 95247 | 8,500 |

Center Nuts



- For attaching fiber discs to backing pad and tool
- Use small* for 4", 4-1/2", 5" diameter pads
- Use large* for 7", 9" diameter pads

| Size | Part No |
|---------------|---------|
| 5/8-11 Small* | 95040 |
| 5/8-11 Large* | 95041 |
| 1/2-13 | 95042 |
| M10 x 1.25 | 95043 |
| M10 x 1.5 | 95044 |
| M14 x 2.0 | 95045 |

Type 1 Cut-Off Adaptors



- For use with Type 1 Thin High Speed Cut-Off wheels up to 3" diameter only (pg. 39)

| Size | Part No |
|--------------|---------|
| 1/4 x 1/4-20 | 95002 |
| 1/4 x 3/8-24 | 95003 |
| 1/4 x 1/2-20 | 95004 |

Type 27 Reusable Adaptor Kit



- For use with Type 27 wheels on 7" and 9" 5/8-11 spindle grinders
- Alternative to a throwaway hub

| Description | Part No |
|----------------------|---------|
| Reusable Adaptor Kit | 95000 |

Type 1 & Type 27 Reusable 5/8-11 Adaptor



- Reusable 5/8-11 adaptor for use on Type 1 and Type 27 reinforced wheels with a 7/8 arbor, a max. diameter of 5" and a wheel thickness of .045 to 1/8"

| Description | Part No |
|-------------------------|---------|
| 5/8-11 Reusable Adaptor | 95055 |

Type 1 Cut-Off Wheel Reducing Bushings



- For use with Type 1 Cut-Off wheels
- Reduces wheel arbor size

| Size | Part No |
|--------|---------|
| 1-5/8 | 95030 |
| 1-20mm | 95031 |
| 1-7/8 | 95032 |
| 1-3/4 | 95033 |

| Size | Part No |
|----------|---------|
| 7/8-5/8 | 95034 |
| Dia.-5/8 | 95035 |
| Dia.-1/2 | 95036 |
| 1/2-3/8 | 95037 |

PSA Backing Pads



- For use with PSA adhesive backed sanding discs (pg. 81-83, 86)
- 1/4" Shank pads for die grinders
- Threaded pads for dual action/random orbital sanders and right angle grinders/sanders



Portable Grinder

| Size | Part No | Max RPM |
|-------------|---------|---------|
| 1 x 1/4 | 95059 | 30,000 |
| 1-1/2 x 1/4 | 95060 | 30,000 |
| 2 x 1/4 | 95061 | 28,000 |
| 3 x 1/4 | 95062 | 20,000 |
| 4 x 1/4 | 95063 | 16,000 |
| 5 x 1/4 | 95064 | 12,000 |



Disc Sander

| Size | Part No | Max RPM |
|---------------------|---------|---------|
| 5 x 5/16-24 | 95065 | 10,000 |
| 5 x 5/16-24 5 holes | 95085 | 10,000 |
| 6 x 5/16-24 | 95066 | 10,000 |
| 6 x 5/16-24 6 holes | 95086 | 10,000 |
| 8" w/mounting holes | 95180 | 1,500 |

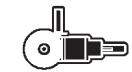

Angle Grinder

| Size | Part No | Max RPM |
|------------|---------|---------|
| 7 x 5/8-11 | 95068 | 4,800 |
| 8 x 5/8-11 | 95067 | 4,800 |

Hook & Loop Backing Pads for Paper Discs



- For use with Hook & Loop backed paper discs (pg. 84-85)
- Available in 5/16-24 thread

| Description | Part No | Max RPM |
|------------------------|---------|---------|
| 5 x 5/16-24 | 95047 | 10,000 |
| 5 x 5/16-24 5 holes | 95057 | 10,000 |
| 5 x 5/16-24 8 holes | 95058 | 10,000 |
| 6 x 5/16-24 | 95046 | 10,000 |
| 6 x 5/16-24 6 holes | 95056 | 10,000 |
| 8" w/ 5 mounting holes | 95185 | 1,500 |
| 8 x 5/8-11 | 95187 | 1,500 |

Palm Hand Sander



- For manual use with PSA (pp. 81-83) or Sand-Light™ /Hook & Loop discs (pg. 120, 127)
- For more uniform finish when hand sanding

| Size | PSA | Sand-Light™ |
|------|-------|-------------|
| 5" | 95091 | 95081 |
| 6" | 95092 | 95082 |

Contour Hand Pads



- For manual use with PSA or Hook & Loop discs (pg. 81-85)
- For more uniform finish when hand sanding

| Size | PSA | Hook & Loop |
|------|-------|-------------|
| 6" | 95260 | 95250 |

Hook & Loop Soft Interface Pads

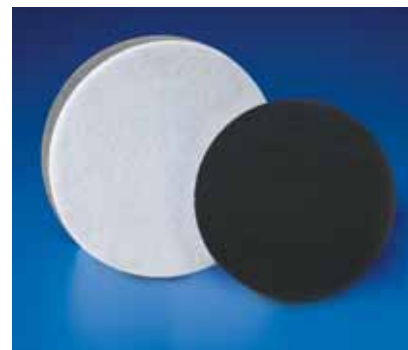

- For use with 5" and 6" Hook & Loop Backing Pads
- Excellent for final finishing as the soft foam backing makes the grain cut less and finish finer
- The perfect compliment for the 4S/4V Hook & Loop products (pg. 84-85)

| Description | Part No |
|-----------------------------------|---------|
| 5" Soft Interface Hook & Loop Pad | 95175 |
| 6" Soft Interface Hook & Loop Pad | 95176 |

Sand-Light™ Surface Conditioning Backing Pads



- For use with Hook & Loop style Sand-Light™ Discs (pg. 120, 127)
- 1/4" shank pads
- Threaded pads for dual action random orbital sanders
- Threaded pads for right angle grinders/sanders

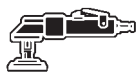

Portable Grinder

| Size | Part No | Max RPM |
|---------|---------|---------|
| 4 x 1/4 | 95154 | 6,000 |
| 5 x 1/4 | 95153 | 6,000 |



Disc Sander

| Size | Part No | Max RPM |
|-------------|---------|---------|
| 4 x 5/16-24 | 95157 | 10,000 |
| 5 x 5/16-24 | 95155 | 10,000 |
| 6 x 5/16-24 | 95156 | 10,000 |

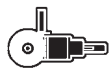

Angle Grinder

| Size | Part No | Max RPM |
|----------------|---------|---------|
| 4-1/2 x 5/8-11 | 95159 | 4,800 |
| 5 x 5/8-11 | 95160 | 4,800 |
| 6 x 5/8-11 | 95161 | 4,800 |
| 7 x 5/8-11 | 95162 | 4,800 |
| 8 x 5/8-11 | 95163 | 4,800 |

Sand-Light™ Handle



- For manual use with Sand-Light™ 6 x 9 hand pads (pg. 117)
- For more uniform finish when hand sanding

| Description | Part No |
|--------------------|---------|
| Sand-Light™ Handle | 95080 |

SAIT-LOK™ Backing Pads for Laminated & Surface Conditioning Discs



- For use with SAIT-LOK™ laminated (pg. 77-79) and surface conditioning discs (pg. 119)
- Disc twists into metal threaded center of backing pad for fast and easy disc changes
- Now available in hard density for aggressive cutting action
- 1/4" shank

| Size | Part No | Max RPM | Size | Part No | Max RPM |
|---------------|---------|---------|-------------|---------|---------|
| 1" Medium | 95165 | 40,000 | 1-1/2" Hard | 95266 | 30,000 |
| 1-1/2" Medium | 95166 | 25,000 | 2" Hard | 95267 | 30,000 |
| 2" Medium | 95167 | 25,000 | 3" Hard | 95268 | 20,000 |
| 3" Medium | 95168 | 20,000 | | | |

SAIT-LOK-R™ Backing Pads for Laminated, Surface Conditioning, & Cotton Fiber Discs

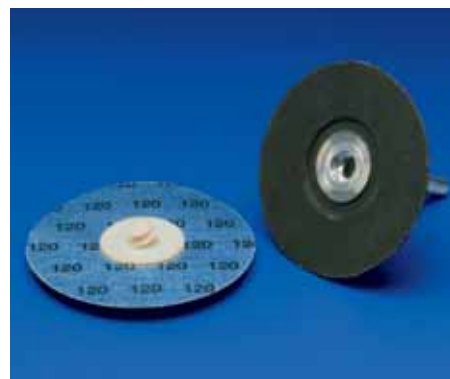

- For use with SAIT-LOK-R™ laminated (pg. 77-79), surface conditioning discs (pg. 119), Cotton fiber discs (pg. 59)
- Nylon threaded hub of disc twists into backing pad for secure fit
- Now available in hard density for aggressive cutting action
- Minimizes change-over time
- 1/4" shank

| Size | Part No | Max RPM | Size | Part No | Max RPM |
|---------------|---------|---------|-------------|---------|---------|
| 1-1/2" Medium | 95171 | 25,000 | 1-1/2" Hard | 95271 | 30,000 |
| 2" Medium | 95172 | 25,000 | 2" Hard | 95272 | 30,000 |
| 3" Medium | 95173 | 20,000 | 3" Hard | 95273 | 20,000 |
| 4" Medium | 95280 | 12,000 | | | |

Saitlam™ Flap Disc Backing Pad & Nut



6-1/2" Backing Pad Assembly

- Must be used with 6-1/2" Saitlam™ (pg. 94)
- Includes backing pad, nut (5/8-11), and washer

| Description | Part No | Max RPM |
|-----------------------------|---------|---------|
| 6-1/2" Saitlam™ Backing Pad | 95070 | 6,000 |

Saitlam™ Nuts

| Size | Uses Nut | Part No |
|-----------------|------------|---------|
| 4-1/2" Saitlam™ | 5/8-11 | 95071 |
| 4-1/2" Saitlam™ | M14 x 2.0 | 95072 |
| 4" Saitlam™ | M10 x 1.25 | 95074 |

Wood Wedges



- For use with Vitrified Bonded Floor Rubs (pg. 60)
- Skin packaged in quantities of 2 per package

| Description | Part No |
|-------------|---------|
| Wood Wedges | 95100 |

Flap Wheel Adaptor 1-5/8" Metal Bushing



- For use on 6" Flap wheels
- Skin packaged in quantities of 2

| Description | Part No |
|----------------------|---------|
| 1-5/8" Metal Bushing | 95109 |

Abrasive Cleaning Stick



- For removing loaded material from sanding belts
- Increases abrasive life
- 100% natural rubber; environmentally safe
- Lasts twice as long as conventional (crepe) belt cleaners and will not cause gummy residue
- Size: 1-5/8" x 1-5/8" x 8"

| Description | Part No |
|-------------------------|---------|
| Abrasive Cleaning Stick | 95083 |

1/4" Shank Threaded Adaptor for Flap Wheels



- For use on United Abrasives 1/4-20 threaded flap wheels
- Facilitates a quick change, thus less downtime

| Description | Part No |
|-----------------------|---------|
| 1/4" Threaded Adaptor | 95050 |

1/4" Shank Adaptor Kit for Flap Wheels



- For converting 1" or 5/8" arbors to a 1/4" shank
- 1/4" Shank adaptor kit

| Description | Part No |
|-------------|---------|
| Adaptor Kit | 95009 |

Cartridge Roll Mandrels



- For use with straight and full taper cartridge rolls on pages 108-109

| Size | Part No |
|--------------------|---------|
| 1/4 x 1-1/2 x 1/4 | 95101 |
| 1/4 x 1 x 1/4 | 95102 |
| 1/8 x 1-1/2 x 1/4 | 95103 |
| 1/8 x 1 x 1/4 | 95104 |
| 1/8 x 3/4 x 1/4 | 95105 |
| 3/16 x 1-1/2 x 1/4 | 95106 |
| 3/16 x 1 x 1/4 | 95107 |
| 3/32 x 3/4 x 1/4 | 95108 |

Spiral Band Drums



- For use with spiral bands on page 107

| Size | Max RPM | Part No |
|---------------------|---------|---------|
| 1/2 x 1/2 x 1/4 | 30,000 | 95121 |
| 1/2 x 1 x 1/4 | 15,000 | 95122 |
| 1/2 x 1-1/2 x 1/4 | 12,000 | 95123 |
| 3/4 x 1 x 1/4 | 19,000 | 95126 |
| 3/4 x 1-1/2 x 1/4 | 10,000 | 95127 |
| 1 x 1 x 1/4 | 18,000 | 95130 |
| 1-1/2 x 1 x 1/4 | 14,000 | 95133 |
| 1-1/2 x 1-1/2 x 1/4 | 10,000 | 95134 |
| 2 x 2 x 1/4 | 6,000 | 95137 |
| 3 x 3 x 1/4 | 3,000 | 95140 |

Unitized Wheel Mandrels



- Re-usable mandrels for use with Unitized Wheels
- Packaged each

| Description | Part No | For Use With: |
|--|---------|--|
| Steel Unitized Wheel Mandrel "threaded screw-type" | 95240 | 77830 |
| Type 1 Wheel Adaptor | 95002 | All 3" diameter, 1/4" hole unitized wheels |

Cross Pad & Square Pad Mandrels

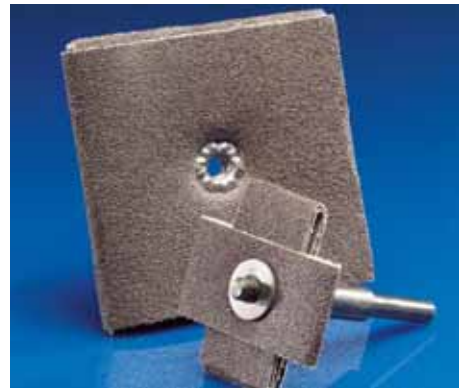

- For use with cross and square pads on page 110
- 1/4" shank

| Size | Part No |
|--------|---------|
| 3-48 | 95095 |
| 8-32 | 95096 |
| 1/4-20 | 95097 |

Fileboard Backing Plates



| Size | PSA | Hook & Loop |
|-----------------|-------|-------------|
| 2-3/4 x 16-1/2" | 95190 | 95195 |

Super Soft Buffing Disc Backing Pads



- For use with buffing discs (pg. 128)
- Available in 5" & 7" with 5/8-11 thread

| Description | Max RPM | Part No |
|------------------------|---------|---------|
| 5" Super Soft Foam Pad | 3,200 | 95255 |
| 7" Super Soft Foam Pad | 3,200 | 95257 |

Buffing Disc Compounds and Kits

Brown Bar: Used for buffing aluminum, brass, copper, wood, plastics, hard rubber, and painted surfaces. Also called tripoli rouge.

White Bar: Used for buffing stainless steel, carbon steel, nickel, aluminum, and chromium to a high luster shine.

Red Bar: For buffing precious metals like gold, silver, platinum, sterling, and other high end metals. Can also be used to further enhance materials that have already been buffed with other compounds. The finest grade.

Black Bar: Used to buff contaminants out prior to finishing. Will remove rust, stains, scale, and other contaminants. An extremely fast cutting material. Also called emery cake.



| Description | Part No |
|---------------------------------|---------|
| Buffing Compound Kit | 41000 |
| 1 lb Buffing Compound Bar Brown | 41024 |
| 1 lb Buffing Compound Bar White | 41022 |
| 1 lb Buffing Compound Bar Red | 41020 |
| 1 lb Buffing Compound Bar Black | 41026 |

Convolute Wheel and Non-Woven Flap Brush Reducing Bushings



- Re-usable reducing bushings for use with Convolute Wheels and Flap Brushes
- Packaged per pair

| Description | Part No | For Use With: |
|--------------------|---------|---|
| 1" OD to 3/8" ID | 95210 | 6" Diameter Convolute Wheels |
| 1" OD to 1/2" ID | 95212 | 6" Diameter Convolute Wheels |
| 1" OD to 5/8" ID | 95214 | 6" Diameter Convolute Wheels |
| 1" OD to 3/4" ID | 95216 | 6" Diameter Convolute Wheels |
| 2" OD to 1" ID | 95220 | 6" Diameter Non-woven Flap Brushes |
| 3" OD to 1" ID | 95230 | 8" Diameter Convolute Wheels and Non-woven Flap Brushes |
| 3" OD to 1-1/4" ID | 95232 | 8" Diameter Convolute Wheels and Non-woven Flap Brushes |

PROMOTIONAL LITERATURE

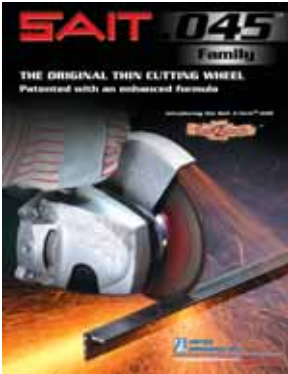

.045 Cut-Off Wheels
Part #99045



Abrasive Steps Tri-Fold
Part #99031



Company Overview
Part #99981

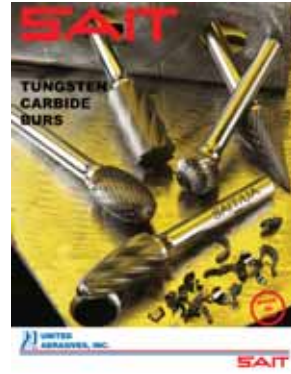

Carbide Burs
Part #99220

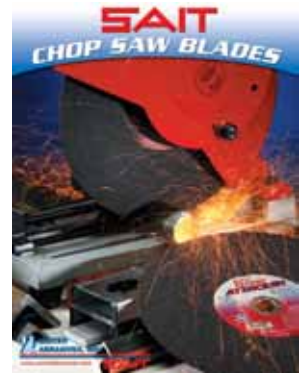

Chop Saw Wheels
Part #99014



.090 Cutting/Notching
Part #99990



Construction Grade
Tri-Fold • Part #99221



Cotton Fiber Products
Part #99026



Fiber Discs
Part #99028

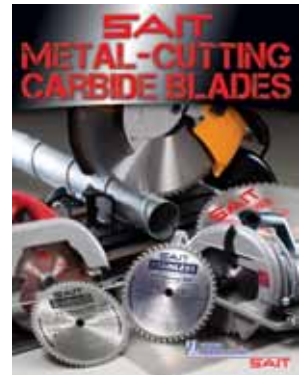

Metal-Cutting Carbide Blades
Part #99982



MRO (Maintenance, Repair & Operations) • Part #99048

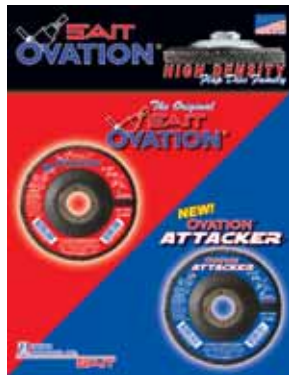

Ovation® Family
Part #99980

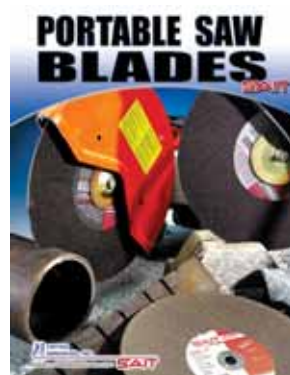

Portable Saw Blades
Part #99040

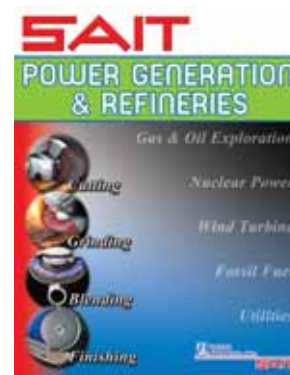

Power Generation & Refineries
Part #99087

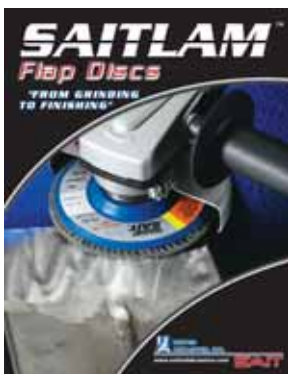

Saitlam™ Flap Discs
Part #99007



Super-Lock™ Hub
Part #99019



Surface Conditioning Products
Part #99027



Wire Brushes
Part #99005

Pegboard Display



Sample Display

- 1 Hardware Kit
- 6 Sait Back Panels
- 6 Corner Triangles
- 6 Line Cards

Slatwall Display



Rectangle Header Cards - 1 per panel
(used ONLY for Counter and Wall racks)

| Part# | Description |
|-------|---|
| 99104 | Concrete cutting |
| 99105 | Concrete grinding |
| 99106 | Flap discs |
| 99107 | Metal cutting |
| 99108 | Metal grinding |
| 99109 | Metal grinding/blending |
| 99110 | Stainless Steel cutting |
| 99111 | Stainless Steel grinding |
| 99112 | Wire Brushes |
| 99113 | Accessories |
| 99114 | Aluminum |
| 99117 | Metal/Stainless Steel cutting |
| 99118 | Metal/Stainless Steel grinding |
| 99122 | Stainless Steel/Aluminum blending/finishing |
| 99123 | Belts |
| 99089 | Double sided Ovation®/Ovation® Attacker® |

Counter Rack POP

Counter Display Rack
Part# 99079
h17" x w15.5" x d11"



4" hooks do NOT come with racks
Set of 4 hooks for Counter Rack
Part # 99100



Wall Rack POP

Flat Wall Display Rack
Part # 99078
h24" x w15.5"

4" hooks do NOT come with racks

Set of 6 hooks for Wall Rack
Part # 99115

Hang Tag

For use with Wall Rack and Counter Rack
Part # 99080 (order in multiples of 50)



9 x 11 Sandpaper Rack POP

9x11 Sheet Rack
Part # 99077
h24" x w9.5" x d11.5"

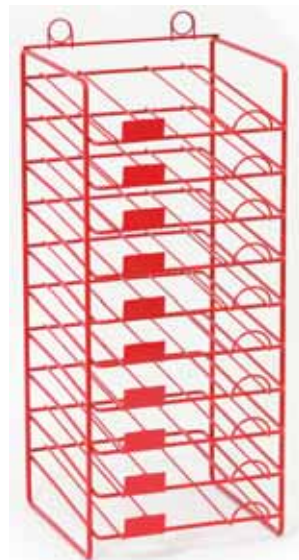

9 x 11 Header Card

Part # 99081
(does not come with POP)



TECHNICAL & REFERENCE MATERIAL



Safety Guide

Important:

The following information about safety should be used only as a guide. All products listed in this catalog shall be used in accordance with safety regulations set by OSHA and by the directive described by the American National Safety Institute B7.1, the Canadian Standard Association Safety Code B-173-5 and by the American Brush Manufacturers Association covering: Speed, Safety Guards, Flanges, Mounting Procedures, General Operating Rules, Handling, Storage, and Inspection of General Machine Conditions.

The information to the right is designed as a guide for the individual user of abrasive wheels, whether he be in the employ of a large corporation or in the confines of his home work shop. It is based on the premise that grinding/cutting is a safe operation when a few basic rules are followed. These rules are based on material contained in the American National Standards Institute Safety Requirements B7.1 - "Use, Care & Protection of Abrasive Wheels." Follow Them.



Warning:

Avoid inhalation of dust generated by grinding and cutting operations. Exposure to dust may cause respiratory ailments as well as irritation to eyes and skin. In most cases, a greater hazard is the exposure to the dust/fumes from the base material being ground or paint or coatings applied to it. Use approved NIOSH or MSHA respirators, safety glasses or face shields, gloves and protective clothing. Provide adequate ventilation to eliminate dust or to maintain dust levels below the permissible exposure level for nuisance dust as classified by OSHA. Refer to Material Safety Data Sheet for further information.

All operators must read and understand safety information thoroughly.

Follow Safety Instructions:

You must follow all operator and safety instructions, as well as all common safety practices which reduce the likelihood of physical injury.

Operate Wheels at Recommended Speeds:

It is imperative that abrasive wheels be operated at recommended safe speeds. For safety reasons no abrasive wheel shall be operated at a speed greater than that indicated on the blotter or wheel.

- Do always handle and store wheels in a careful manner.
- Do visually inspect all wheels before mounting for possible damage.
- Do make sure operating speed of machine does not exceed speed marked on wheel, its blotter or container.
- Do check mounting flanges for equal size, relieved as required & correct diameter.
- Do use mounting blotters as required by ANSI standards.
- Do be sure work rest is properly adjusted on bench, pedestal and floor stand grinders.
- Do always use safety guard that covers a minimum of one-half (1/2) the abrasive wheel.
- Do allow newly mounted wheels to run at operating speed, with guard in place, for at least one minute before grinding.
- Do always wear safety glasses or some type of approved eye protection while grinding or cutting.
- Do turn off coolant before stopping wheel to avoid creating an out-of-balance condition.
- Do follow common sense safety considerations.
- Do follow federal, state and local laws and regulations.
- Don't use a wheel that has been dropped or appears to have been abused.
- Don't force a wheel onto the machine or alter the size of the mounting hole. If wheel won't fit the machine, get one that will.
- Don't ever exceed maximum operating speed established for the wheel.
- Don't use mounting flanges on which the bearing surfaces are not clean, flat and smooth.
- Don't tighten the mounting nut excessively.
- Don't grind on the side of conventional, straight or Type 1 wheels.
- Don't use a wheel on any machine that is not properly designed for the specific application of the wheel.
- Don't start the machine until the safety guard is properly and securely in place.
- Don't jam work into the wheel.
- Don't stand directly in front of a grinding/cutting wheel whenever a machine is in operation.
- Don't grind or cut material for which the wheel is not designed.

A pamphlet including these Do's and Don'ts and other safety information is included in each box of wheels.

Exclusive Super-Lock™ Hub

Super-Lock™ combines a mechanically interlocked transversed key lock system and uses a unique two-part bonding system to give it superior performance capabilities. Other manufacturers use hubs that depend upon two part epoxy, which can fail in many instances due to poor surface preparation, improper curing conditions, incorrect ratio of catalyst and epoxy, or the quantity of epoxy material applied.

Unique in the industry

The United Abrasives Super-Lock™ system is our exclusive, fail-safe throw away hub assembly. This is a unique hubbing system that is used on Type 27 and Type 28 grinding and cutting wheels where hub mounting is preferred.

Unsurpassed Performance

The rotational torque placed upon wheels can vary based on material being removed and pressure that is applied. While the chemical bonds that other manufacturers use can fail, the Super-Lock™ Hub ensures the stability of the hub to wheel connection.

Millions sold - Not one Failure

Since 1983, United Abrasives has manufactured and sold millions of depressed center wheels with Super-Lock™ Hubs. Not a single one has ever been reported as a failure.

Patented

The Super-Lock™ Hub system is so safe that it was originally protected by United States patent #4,541,205. United Abrasives is the only manufacturer to utilize this outstanding hub system.

Use on Type 27 and Type 28 Wheels

The Super-Lock™ Hub System is available on all 4-1/2", 5", 7" and 9" Type 27 and Type 28 depressed center grinding and cutting wheels. Turbo 4-1/2" and 5"x1/8" and .090 wheels do not have Super-Lock™ Hub.

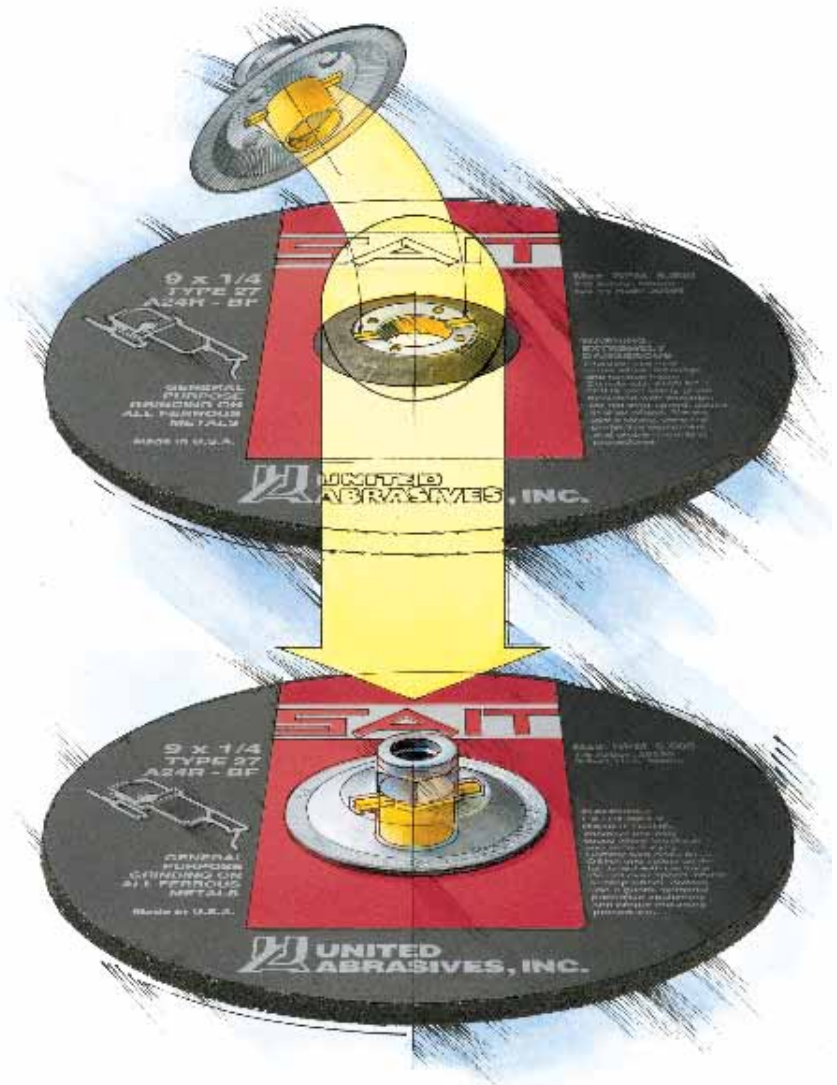

Look for this drawing throughout the catalog indicating the wheels that are available with the Super-Lock™ Hub



Resin Bonded Abrasives

ANSI Standard Marking System

The following chart is an example of the ANSI standard marking system for identifying grinding wheels and other bonded abrasives

| A | 24 | | | | R | | | BF |
|--------------------------------------|----------------------------|--------|------|-----------|----------------------|--------|------|------------------------|
| Primary grain used to make the wheel | Size of the abrasive grain | | | | Hardness of the bond | | | Type of bond used |
| | Coarse | Medium | Fine | Very Fine | Soft | Medium | Hard | |
| A = Aluminum Oxide | 8 | 30 | 70 | 220 | ←—————→ | | | B Resinoid |
| C = Silicon Carbide | 10 | 36 | 80 | 240 | A | N | R | BF Resinoid Reinforced |
| Z = Alumina Zirconium | 12 | 46 | 90 | 280 | | | T | E Shellac |
| SG = Seeded Gel | 14 | 54 | 100 | 320 | | | Z | O Oxychloride |
| | 16 | 60 | 120 | 400 | | | | R Rubber |
| | 20 | | 150 | 500 | | | | RF Rubber Reinforced |
| | 24 | | 180 | 600 | | | | S Silicate |
| | | | | | | | | V Vitrified |

Wheel Configurations

Bonded abrasive wheels have different configurations depending upon the tool the wheel is used on and the desired end result. Below are the configurations that a wheel can have:

Each wheel configuration is shown on the pages throughout this catalog. The A, B, and C connotations represent the size of the wheel.

A = The diameter of the wheel
 B = The width or thickness of the wheel
 C = The bore of the wheel

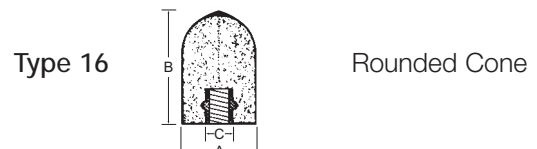
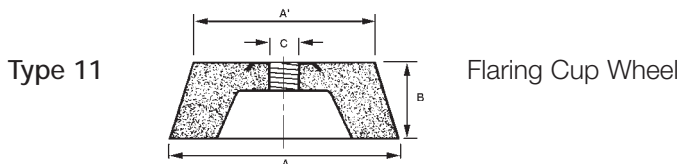
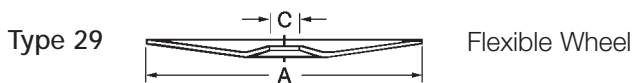
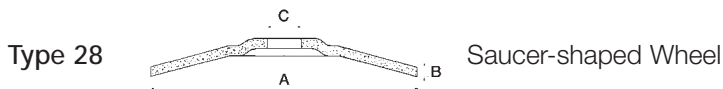
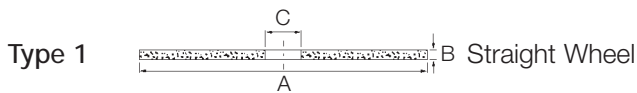

Resin Bonded Abrasives

Sample of Wheel Label

Below is an example of a label that can be found on United Abrasives' wheels. We feel it is important to include as much information as possible on our labels so the end user has the pertinent information he needs to operate the wheel. All of our labels are baked on the wheels during the manufacturing process, so the label remains intact throughout the life of the wheel.



Wheel Label Color Coding:

METAL

STAINLESS

ALUMINUM

CONCRETE

Storage and Handling

All abrasive wheels are breakable and therefore care shall be exercised in handling and storage to prevent damage. The following rules, which are based on experience, should be observed:

- Handle wheel carefully to prevent dropping or bumping
- Do not roll wheels (hoop fashion)
- Use trucks or other suitable conveyances to provide support and protection in transporting all wheels which cannot be carried by hand
- Suitable racks, bins, drawers or boxes shall be provided to store the various types of wheels used
- Abrasive wheels should be stored in a dry area not subject to extreme temperature changes since some bonds may be affected by excessive humidity and temperature differentials
- Racks should be located as near as practical to the grinding location, but never where there is danger of damage from passing trucks, crane handling equipment or excessive vibration

Anatomy of a Wheel

What is a Bonded Abrasive?

A resin bonded abrasive is a grinding or cutting tool composed of abrasive grains which are held tightly together by a bonding agent and typically reinforced with a woven material. Within the bonded abrasives category are grinding and cutting wheels, as well as "stones" in a variety of shapes and sizes.

3 Main Components of Resinoid Bonded Abrasives

① Abrasive Grains

Abrasive grains are particles of man-made abrasive compounds. While some manufacturers use recycled grains, United Abrasives uses only high quality, virgin grains that are made to our specifications. The chemical structure of the grains determines the physical properties of the grains (i.e. shape, sharpness, hardness, friability). Common grain types used in making bonded abrasives include:

- **A - Aluminum Oxide**
A tough blocky shaped grain used for cutting metals and other high tensile strength materials without excessive fracturing
- **C - Silicon Carbide**
A very hard and very sharp abrasive suited for non-metallic materials such as concrete
- **Z - Alumina Zirconium** (also referred to as Zirconium)
A very fine, dense crystalline grain which can be used for rugged stock removal
- **SG - 3M Cubitron™**
An exclusive patented ceramic aluminum oxide, two or three times tougher than standard aluminum oxide

② Bonding Agent

The bonding agent that holds the grains together determines the resistance of the wheel. United Abrasives uses a resinoid bond that is formulated to meet the unique specifications of each product.

③ Reinforcement

The reinforcement material provides extra strength to use the wheel at maximum RPMs and withstand lateral pressure that is applied during use. United Abrasives uses multiple layers of long stranded fiberglass which are woven to form an exceptionally strong reinforcement layer specific to the application.

Combining the 3 Components

During the manufacturing process, these three components are combined to form a grinding wheel. The grains and bonding agents are measured, combined, and pressed in an automated hydraulic press. United Abrasives' labels are also incorporated into the manufacturing process and therefore remain intact throughout the life of the wheel.

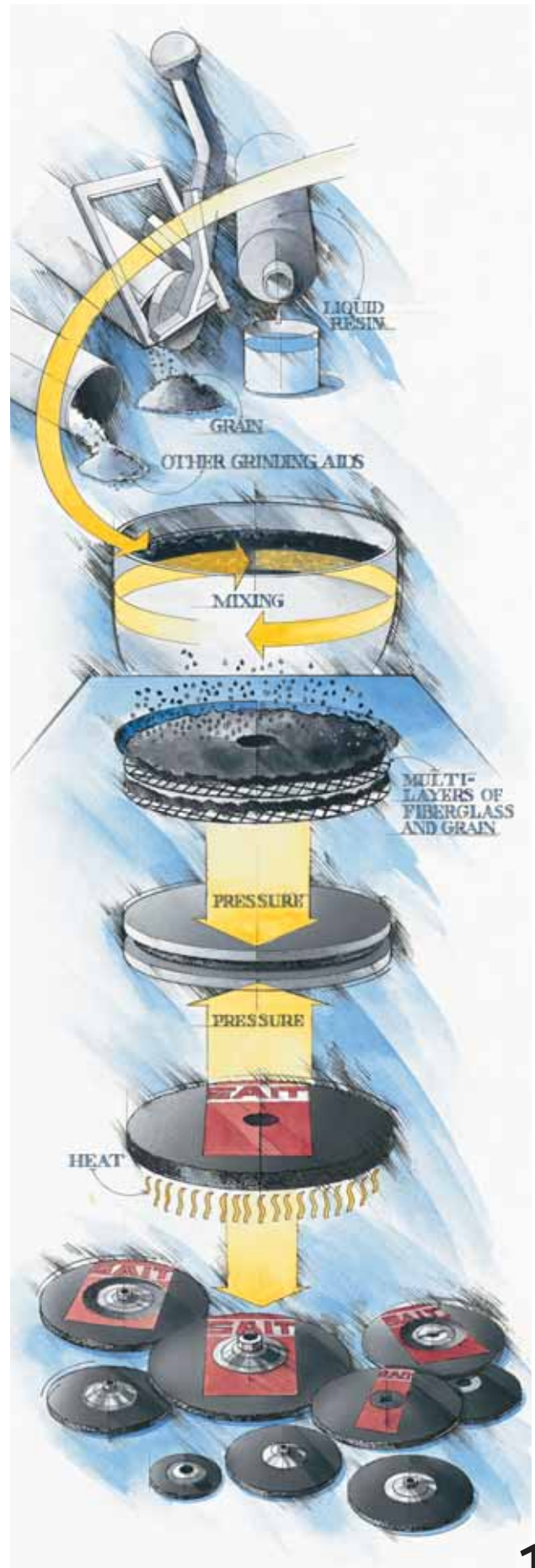

How a Wheel Works

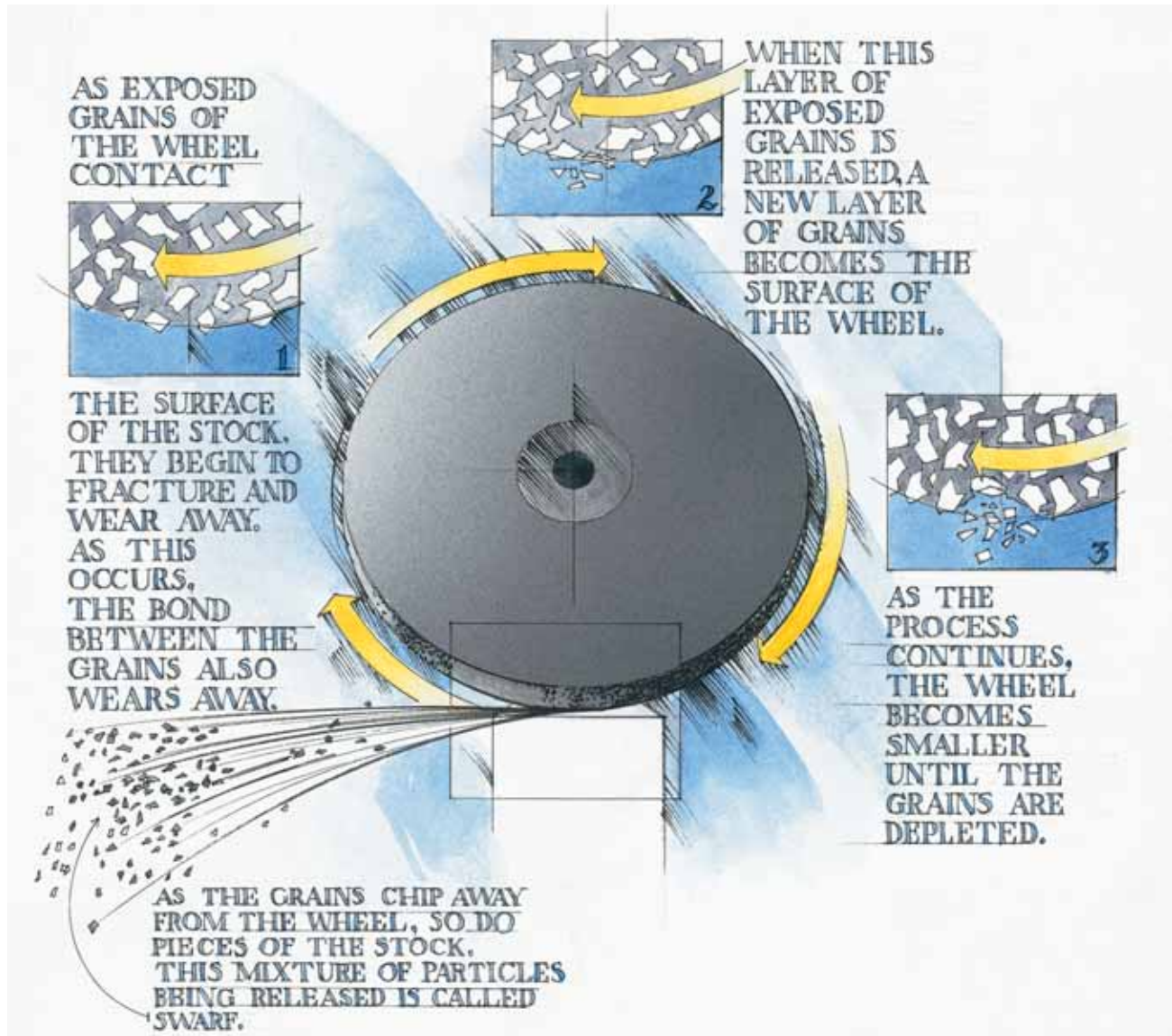

Common Occurrences With Grinding/Cutting Applications

As a wheel is grinding and/or cutting, some situations may occur with the application such as glazing or loading. Here is a description of each of these occurrences and some possible solutions.

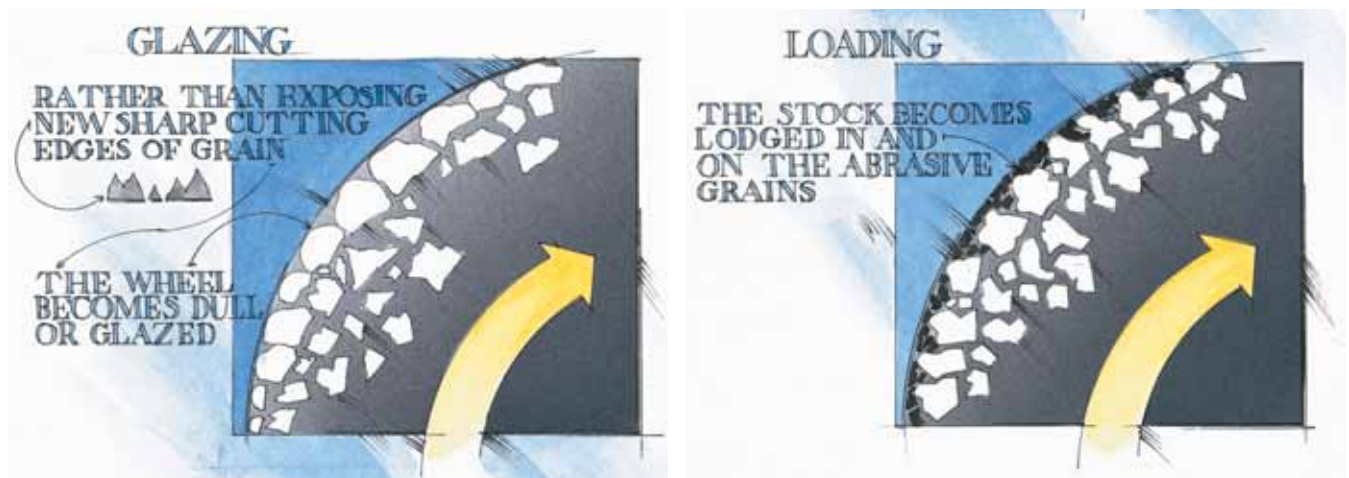

Solutions to Glazing

- Dress the wheel for a temporary solution
- Use a softer bond and/or coarser grit wheel

Solutions to Loading

- Dress the wheel for a temporary solution
- Use the correct wheel for the application

COATED ABRASIVES

OVERVIEW



What is a Coated Abrasive?

A coated abrasive is a product that consists of a thin layer of abrasive grain attached to a substrate such as paper, cloth, etc. Coated abrasives come in a variety of forms such as sheets, discs, rolls, specialties, or belts.

Components of Coated Abrasives

Abrasive Grains

Coated abrasives are manufactured using abrasive grains, the most common being aluminum oxide, zirconium, ceramic, silicon carbide and garnet. The crude grains are crushed and separated into sizes, called grit sizes, using calibrated screens. Grits range from 12 (very coarse) to 1200 (very fine.) Once the grains are separated into sizes, they are attached to a backing material using various bond techniques. Below are descriptions of the most common abrasive grains:

Ceramic:

A high performance, man-made abrasive material. Very uniform, high density grain structure is extremely durable and self sharpening for longer life and cooler cut. Excels on tough to grind materials.

Aluminum Oxide:

A tough, blocky shaped, man-made grain used for high speed grinding and finishing of metals, wood, and other high tensile strength materials without excessive fracturing or shedding. Wherever the ability to resist fracturing is the main consideration, aluminum oxide will outperform all other coated abrasive grains.

Zirconium:

A very fine, dense, man-made crystalline grain which can be used for aggressive stock removal. Zirconium is a very dense material with a unique self-sharpening characteristic which gives it long life on heavy stock removal operations.

Silicon Carbide:

A very hard, very sharp, man-made abrasive suited for non-ferrous materials and non-metallic materials such as concrete, marble and glass. A very friable grain, silicon carbide cuts faster under light pressure than any other grain used in coated abrasives.

Garnet:

Garnet is made of natural aluminum oxide which is a relatively sharp, but very weak bonding structure. Very inconsistent when compared to synthetics. It is used primarily in woodworking as garnet dulls too quickly to be used in metalworking.

Backing Materials (Substrates)

Below are the four major types of backing materials:

Paper

Specialized technical papers are used as substrates for coated abrasives. They are identified by letters representing weight and flexibility:

"A" and "B" weights are light weight and highly flexible. "C", "D", "E", "F" weights are medium to heavy weight for more strength and less flexibility.

Cloth

Cloth backings are more durable than paper backings. There are two common types of cloth backing, cotton (ie: Egyptian) and polyester. Cloth backings are identified by weight and flexibility:

"F" weight (J-Flex) is light and highly flexible. This lighter weight is suitable for cleaning, finishing, and polishing.

"J" weight (Jeans) is highly flexible and suitable for cleaning, finishing, and polishing of contour surfaces.

"X" weight (Drills) is medium to heavy weight for more strength and durability. It has low flexibility suitable for grinding, deburring and finishing.

"H" (Heavy Duty) is a heavier weight than "X" weight. It has low flexibility and is suitable for heavy duty grinding and deburring applications. Excellent edge stability.

Fiber

Fiber backing is a tough vulcanized material made from rag stock. This backing is usually used for abrasive fiber discs.

Combination

Combination backing is laminated paper and cloth, and is very sturdy and shock resistant. Combination backings typically are used for a wide range of grits and mounting techniques.

Other Backing Materials

There are also a variety of other substrates such as nylon fiber or screens that can be coated for special applications. Non-woven nylon impregnated with abrasive grain is another substrate that can be used for cleaning, polishing, or blending.



COATED ABRASIVES OVERVIEW

Bond Techniques

The grains are locked to the backing material using a bond technique that involves a two layer process. There are three major types of bond techniques used in coated abrasives:

Resin over Resin

A very strong bond resistant to heat and moisture. Resin over resin bonds are durable for heavy stock removal and is by far, the most popular bonding method.

Resin over Glue

A bond that is resistant to heat. It is more aggressive than glue over glue bonds and leaves a finer finish than resin over resin bonds.

Glue over Glue

A bond that is less durable than resin bonds, but glue over glue bonds produce a more uniform finish. Glue over glue bonds softens under heat, thereby reducing the life of the product.

All coated abrasives are stiff and rigid after the drying and curing of the bond. To achieve the flexibility required for the application, a mechanical flexing process is required. This process is actually a controlled cracking of the bond in one or more directions to achieve the desired flexibility.

Open Coat vs. Closed Coat

These terms refer to the spacing between the abrasive grains bonded to the backing.

Closed Coat

Closed coat means the abrasive grains are adjacent to each other with no space between. The majority of applications will benefit from closed coat material because it allows for more material removal.

Open Coat

Open coat means the grains are set apart from each other, achieving a surface coverage of about 60% or more. In situations where loading is likely (soft, non-ferrous materials, painted surface, wood, etc.) open coat will resist loading and clogging and extend the useful life of the abrasive.

Making Coated Abrasives

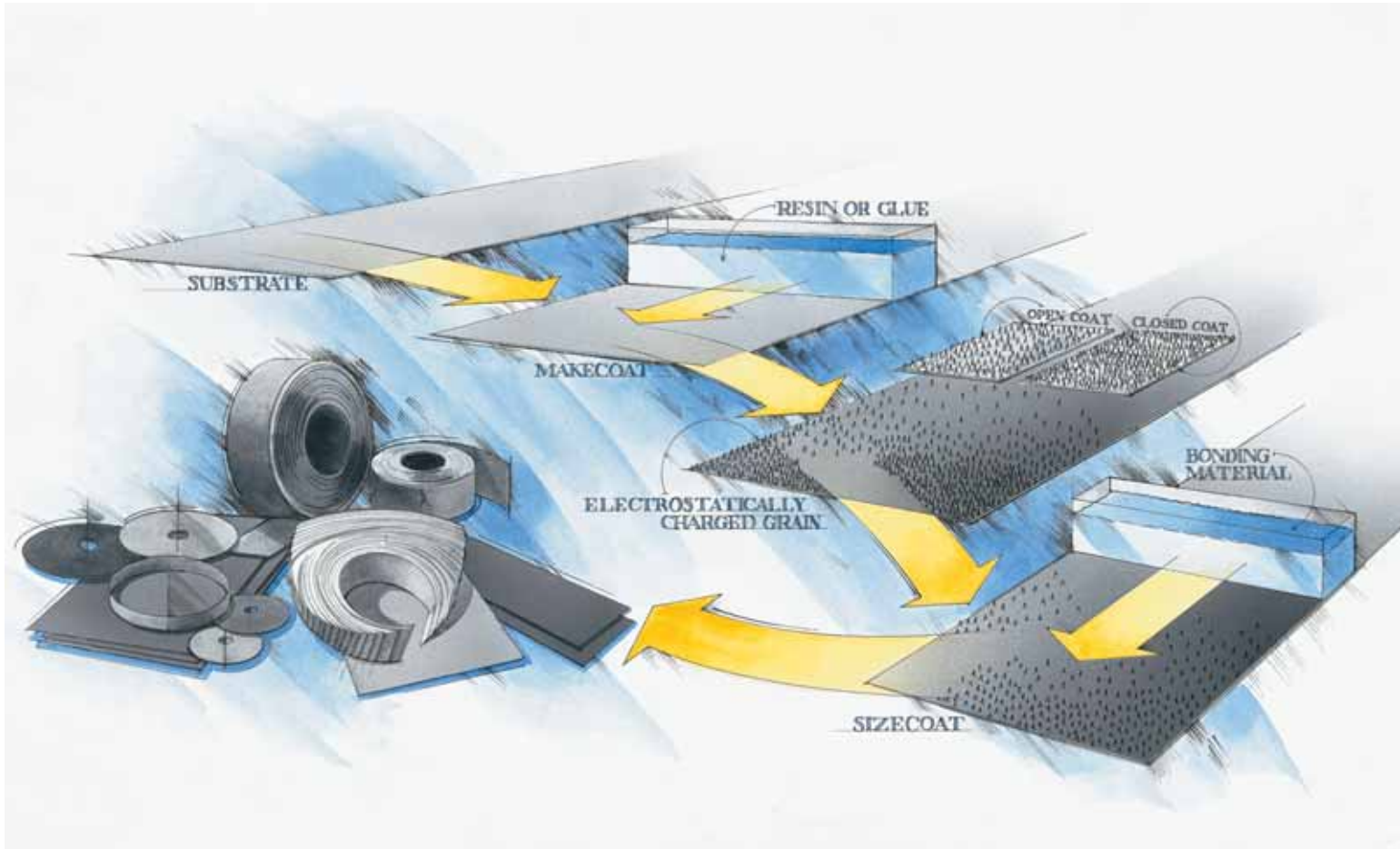

Storage and Handling

Incorrect storage of coated abrasives will significantly affect performance. All types of backings are susceptible to variations in temperature and humidity during storage:

- Keep stockroom at constant levels of humidity (35-50%) and temperature (60-80° F)
- Keep cartons away from damp or cold walls and floors where they may absorb moisture
- Store coated abrasives away from any heat source
- Keep products in original packages for easy handling and stacking
- Flap wheels removed from the original packaging should be spread out on a clean shelf, always placed face down, never resting on edge
- Fiber discs removed from the original packaging should be stored in a suitable disc holder and kept under pressure
- Store bulk rolls flat on shelves or pallets, not on edge
- Belts removed from packing case should be rolled up and stood on edge on a clean shelf. They may be draped over a large cylinder but never hang a belt from a nail or peg (the backing will crease and the abrasive coat will crack)
- Precondition the coated abrasive products in a humidity and temperature controlled environment before use for maximum efficiency

Bonded Application Chart

Ferrous Metals *

| | Angle Iron | Bar Stock | Cast Iron / Ductile Pipe | Carbon Steel | Channel Iron | Decking | Heavy Rebar | High Tensile Steel | Iron Pipe | I-Beams / Rail Steel | Light Gauge Metals | Metal Studding | Metal Tubing | Stainless Steel | Steel | Thin Rebar | Welds |
|--|------------|-----------|--------------------------|--------------|--------------|---------|-------------|--------------------|-----------|----------------------|--------------------|----------------|--------------|-----------------|-------|------------|-------|
| Type 27 Grinding Wheels | | | | | | | | | | | | | | | | | |
| A24N | . | . | . | . | . | . | . | . | . | . | . | . | . | . | . | . | . |
| A24R | . | . | . | . | . | . | . | . | . | . | . | . | . | . | . | . | . |
| A24T | . | . | . | . | . | . | . | . | . | . | . | . | . | . | . | . | . |
| C24N | . | . | . | . | . | . | . | . | . | . | . | . | . | . | . | . | . |
| Type 27 Specialty Grinding Wheels | | | | | | | | | | | | | | | | | |
| A46N | . | . | . | . | . | . | . | . | . | . | . | . | . | . | . | . | . |
| A24 Turbo | . | . | . | . | . | . | . | . | . | . | . | . | . | . | . | . | . |
| Sait Z-tech | . | . | . | . | . | . | . | . | . | . | . | . | . | . | . | . | . |
| Saitech Ultimate Performance™ | . | . | . | . | . | . | . | . | . | . | . | . | . | . | . | . | . |
| Saitech Attacker® | . | . | . | . | . | . | . | . | . | . | . | . | . | . | . | . | . |
| Stainless Contaminant Free | . | . | . | . | . | . | . | . | . | . | . | . | . | . | . | . | . |
| Type 28 Grinding Wheels | | | | | | | | | | | | | | | | | |
| A24N | . | . | . | . | . | . | . | . | . | . | . | . | . | . | . | . | . |
| A24R | . | . | . | . | . | . | . | . | . | . | . | . | . | . | . | . | . |
| C24N | . | . | . | . | . | . | . | . | . | . | . | . | . | . | . | . | . |
| Saitech Ultimate Performance™ | . | . | . | . | . | . | . | . | . | . | . | . | . | . | . | . | . |
| Type 29 Flexible Grinding/Blending Wheels | | | | | | | | | | | | | | | | | |
| Challenger II™ | . | . | . | . | . | . | . | . | . | . | . | . | . | . | . | . | . |
| Type 27 Specialty Cutting & Light Grinding Wheels | | | | | | | | | | | | | | | | | |
| Pipeline/Turbo | . | . | . | . | . | . | . | . | . | . | . | . | . | . | . | . | . |
| Sait Z-tech™ Pipeline | . | . | . | . | . | . | . | . | . | . | . | . | . | . | . | . | . |
| Saitech™ Pipeline (S Pipe) | . | . | . | . | . | . | . | . | . | . | . | . | . | . | . | . | . |
| Type 27 Cutting Wheels | | | | | | | | | | | | | | | | | |
| A24R | . | . | . | . | . | . | . | . | . | . | . | . | . | . | . | . | . |
| .090 | . | . | . | . | . | . | . | . | . | . | . | . | . | . | . | . | . |
| C24R | . | . | . | . | . | . | . | . | . | . | . | . | . | . | . | . | . |
| Type 27 Specialty Cutting Wheels | | | | | | | | | | | | | | | | | |
| Sait Z-tech™ | . | . | . | . | . | . | . | . | . | . | . | . | . | . | . | . | . |
| .045 Aluminum | . | . | . | . | . | . | . | . | . | . | . | . | . | . | . | . | . |
| Saitech UP™ / Saitech™ .045, Z-tech™ .045 | . | . | . | . | . | . | . | . | . | . | . | . | . | . | . | . | . |
| Stainless Contaminant Free | . | . | . | . | . | . | . | . | . | . | . | . | . | . | . | . | . |
| Type 1 Chop Saw Wheels | | | | | | | | | | | | | | | | | |
| EZ-Chop Attacker® /Z-tech™ | . | . | . | . | . | . | . | . | . | . | . | . | . | . | . | . | . |
| EZ-Chop® /Stud King® | . | . | . | . | . | . | . | . | . | . | . | . | . | . | . | . | . |
| Saitech Steel Worker® | . | . | . | . | . | . | . | . | . | . | . | . | . | . | . | . | . |
| Iron Worker™ | . | . | . | . | . | . | . | . | . | . | . | . | . | . | . | . | . |
| Non-ferrous Metals (Alum) | . | . | . | . | . | . | . | . | . | . | . | . | . | . | . | . | . |
| Type 1 High Speed Cut-off Wheels for Portable Saws | | | | | | | | | | | | | | | | | |
| A24R | . | . | . | . | . | . | . | . | . | . | . | . | . | . | . | . | . |
| SAIT-Pro | . | . | . | . | . | . | . | . | . | . | . | . | . | . | . | . | . |
| A60S | . | . | . | . | . | . | . | . | . | . | . | . | . | . | . | . | . |
| Saitech™ .045 / Z-tech™ .045 | . | . | . | . | . | . | . | . | . | . | . | . | . | . | . | . | . |
| C24R / XFC | . | . | . | . | . | . | . | . | . | . | . | . | . | . | . | . | . |
| Type 1 Specialty High Speed Cut-off Wheels | | | | | | | | | | | | | | | | | |
| Brute™ | . | . | . | . | . | . | . | . | . | . | . | . | . | . | . | . | . |
| Hobo® | . | . | . | . | . | . | . | . | . | . | . | . | . | . | . | . | . |
| Ductile™ | . | . | . | . | . | . | . | . | . | . | . | . | . | . | . | . | . |
| Big M.A.C.™ | . | . | . | . | . | . | . | . | . | . | . | . | . | . | . | . | . |
| Type 1 Cut-off Wheels for Street Saws | | | | | | | | | | | | | | | | | |
| C16 | . | . | . | . | . | . | . | . | . | . | . | . | . | . | . | . | . |
| C24R | . | . | . | . | . | . | . | . | . | . | . | . | . | . | . | . | . |
| Street Walker™ | . | . | . | . | . | . | . | . | . | . | . | . | . | . | . | . | . |
| Street Runner™ | . | . | . | . | . | . | . | . | . | . | . | . | . | . | . | . | . |
| Type 1 Wheels for Stationary Cut-off Saws | | | | | | | | | | | | | | | | | |
| A24N | . | . | . | . | . | . | . | . | . | . | . | . | . | . | . | . | . |
| A24R | . | . | . | . | . | . | . | . | . | . | . | . | . | . | . | . | . |
| A36R | . | . | . | . | . | . | . | . | . | . | . | . | . | . | . | . | . |
| C24R | . | . | . | . | . | . | . | . | . | . | . | . | . | . | . | . | . |
| Metal-Cutting Carbide Blades | | | | | | | | | | | | | | | | | |
| Type 1 Thin High Speed Cut-off Wheels | | | | | | | | | | | | | | | | | |
| A24R | . | . | . | . | . | . | . | . | . | . | . | . | . | . | . | . | . |
| A36T | . | . | . | . | . | . | . | . | . | . | . | . | . | . | . | . | . |
| A60T | . | . | . | . | . | . | . | . | . | . | . | . | . | . | . | . | . |
| Saitech Ultimate Performance™ | . | . | . | . | . | . | . | . | . | . | . | . | . | . | . | . | . |
| Type 11 Cup Wheels | | | | | | | | | | | | | | | | | |
| A16 | . | . | . | . | . | . | . | . | . | . | . | . | . | . | . | . | . |
| Z16 | . | . | . | . | . | . | . | . | . | . | . | . | . | . | . | . | . |
| C16 | . | . | . | . | . | . | . | . | . | . | . | . | . | . | . | . | . |
| CA16 | . | . | . | . | . | . | . | . | . | . | . | . | . | . | . | . | . |
| Type 16,17,18 Cones & Plugs | | | | | | | | | | | | | | | | | |
| Resin Bonded Mounted Points | | | | | | | | | | | | | | | | | |

* Indicates most common usages

Bonded Application Chart

| Non-Ferrous Metals * | | | | Stone * | | | | | | Other * | | | Page in Catalog | | |
|----------------------|-------|--------|--------|---------|-------|---------|----------|---------|----------------|---------|---------|------------|-----------------|---------|--------|
| Aluminum | Brass | Bronze | Copper | Asphalt | Brick | Ceramic | Concrete | Granite | Green Concrete | Marble | Masonry | Fiberglass | | Plastic | Wood |
| | | | | | | | | | | | | | | | 8 |
| | | | | | | | | | | | | | | | 8 |
| | | | | | | | | | | | | | | | 8 |
| | | | | | * | * | * | * | * | * | * | | | | 14 |
| * | * | * | * | | | | | | | | | | | | 11 |
| | | | | | | | | | | | | | | | 9 |
| | | | | | | | | | | | | | | | 10 |
| | | | | | | | | | | | | | | | 13 |
| * | | | | | | | | | | | | | | | 13 |
| | | | | | | | | | | | | | | | 12 |
| | | | | | | | | | | | | | | | 15 |
| | | | | | * | * | * | * | * | * | * | | | | 15 |
| | | | | | | | | | | | | | | | 17 |
| | | | | | | | | | | | | | | | 16 |
| * | * | * | * | | | | | | | | | * | * | * | 18 |
| | | | | | | | | | | | | | | | 24 |
| | | | | | | | | | | | | | | | 25 |
| | | | | | | | | | | | | | | | 25 |
| | | | | | | | | | | | | | | | 35 |
| * | * | * | * | | * | * | * | * | * | * | * | | | | 32-33 |
| | | | | | | | | | | | | | | | 37 |
| * | | | * | | | | | | | | | | | | 35 |
| | | | | | | | | | | | | | | | 28 |
| | | | | | | | | | | | | | | | 29, 36 |
| | | | | | | | | | | | | | | | 37 |
| | | | | | | | | | | | | | | | 42-43 |
| * | * | * | * | | | | | | | | | | | | 42-43 |
| | | | | | | | | | | | | | | | 43 |
| | | | | | | | | | | | | | | | 43 |
| | | | | | | | | | | | | | | | 44 |
| | | | | | | | | | | | | | | | 44 |
| * | * | * | * | | * | | * | | | | * | | * | | 30 |
| | | | | | | | | | | | | | | | 31 |
| | | | | | | | | | | | | | | | 46 |
| | | | | | | | | | | | | | | | 45 |
| | | | | | | | | | | | | | | | 45 |
| | | | | | * | * | * | * | * | * | * | | * | | 45 |
| | | | | | | | | | | | | | | | 46 |
| | | | | | * | | * | | * | | * | | | | 47 |
| | | | | | * | * | * | * | * | * | * | | * | | 47 |
| | | | | | * | * | * | * | * | * | * | | * | | 47 |
| | | | | | * | * | * | * | * | * | * | | * | | 47 |
| | | | | | | | | | | | | | | | 48 |
| | | | | | | | | | | | | | | | 48 |
| * | * | * | * | | * | * | * | | * | * | * | | | | 48 |
| * | * | * | * | | | | | | | | | | | | 49 |
| | | | | | | | | | | | | | | | 51, 52 |
| | | | | | | | | | | | | * | * | | 38-39 |
| | | | | | | | | | | | | | | | 38-39 |
| | | | | | | | | | | | | | | | 38-39 |
| | | | | | | | | | | | | | | | 38-39 |
| | | | | | | | | | | | | | | | 20 |
| | | | | | | | * | * | | * | * | | | | 20 |
| | | | | | | | * | * | | * | * | | | | 21 |
| | | | | | | | * | * | | * | * | | | | 21 |
| | | | | | | | | | | | | | | | 19 |
| | | | | | | | | | | | | | | | 22 |

* Indicates most common usages

How To Use This Chart

This chart should be used as a reference to match wheel to application. Following these steps will help you utilize this chart to choose the wheel that will best suit your needs

STEPS IN SELECTING A WHEEL

1. Select the material you will be using based upon the choices at the top of the chart.
2. Determine what you want to do to this material?
 - Are you cutting?
 - Are you grinding?
 - Are you cutting and grinding?
 - Are you finishing?
3. What tools do you have available?
4. Once you have followed these steps, select the wheel that will best suit your needs and turn to that page to see more specifications on that product.

Coated Application Chart

| Product | Structure | Adhesive | Backing/Weights | Form | | | | | | | |
|---------------------------------|--------------------|------------------|---|--------|-------|------------|------------|-----------------|-------------|-------|-------------|
| | | | | Sheets | Rolls | SAIT-Saver | Quick Ship | Blue Line Belts | Custom Belt | Discs | Fiber Discs |
| Cloth- Belts | | | | | | | | | | | |
| LA-X | Closed | Resin over Resin | X-Weight Cloth | | | • | | | | | |
| 1A-X | Closed | Resin over Resin | X-Weight Cloth | | | | • | • | | | |
| 2A-X | Closed | Resin over Resin | X-Weight Cloth | | | | • | | • | | |
| 3A-X | Closed | Resin over Resin | X-Weight Cloth | | | | | • | | | |
| AO-X | Open | Resin over Resin | X-Weight Cloth | | | | • | • | • | | |
| 2A-H | Closed | Resin over Resin | H-Weight Polyester | | | | | • | | | |
| C-W | Closed | Resin over Resin | X-Weight Cloth | | | | • | • | • | | |
| Z-H | Closed | Resin over Resin | H-Weight Polyester | | | | • | • | • | | |
| 3Z-H | Closed | Resin over Resin | H-Weight Polyester | | | | | • | | | |
| AZ-X | Closed | Resin over Resin | X Weight Poly/Cotton | | | | | | • | | |
| Cloth- Other | | | | | | | | | | | |
| Aluminum Oxide (AOX) | Open/Closed | Resin over Resin | J-Flex, J, X cloth | • | • | • | • | | | • | • |
| DA-F | Open | Resin over Resin | J-Flex Cloth | | • | | | | | | • |
| EA-F | Open | Resin over Resin | J-Flex Cloth | • | • | | | | | | |
| TA-X | Closed | Resin over Resin | X Weight Cloth | | | | | | | | • |
| 2A-X | Closed | Resin over Resin | X Weight Cloth | | | | | | | | • |
| 3A-X | Closed | Resin over Resin | X Weight Cloth | | | | | | | | • |
| Zirconium | Closed | Resin over Resin | X Cloth, H Polyester | | | | | | | | • |
| 3Z-H | Closed | Resin over Resin | H Polyester | | | | | | | | • |
| AZ-X | Closed | Resin over Resin | X Weight Poly/Cotton | | | | • | | | | |
| Paper- Other | | | | | | | | | | | |
| Zirconium (Z-F) | Closed | Resin over Resin | F | | | | | | | • | |
| Aluminum Oxide (A-E) | Open | Resin over Resin | E | | | | | | | • | |
| Aluminum Oxide (AW-D & AW-C) | Open/Closed | Resin over Resin | C, D | • | | | | | | • | |
| Stearate Aluminum Oxide (3S) | Open | Resin over Resin | C | • | | | | | | • | |
| Stearate Aluminum Oxide (4S/4V) | Open | Resin over Resin | C | • | | | | | | • | |
| Silicon Carbide (CW-C) | Open/Closed | Resin over Resin | C | • | | | | | | • | |
| Silicon Carbide (C-E/C-F) | Closed | Resin over Resin | E, F | | | | | | | • | |
| Garnet | Open | Glue over Glue | | • | | | | | | | |
| Fiber | | | | | | | | | | | |
| 8S (Ceramic) | Closed | Resin over Resin | | | | | | | | | • |
| 9S (Ceramic) | Closed w/ Coolants | Resin over Resin | | | | | | | | | • |
| AO (Aluminum Oxide) | Open | Resin over Resin | | | | | | | | | • |
| 2A (Aluminum Oxide) | Closed | Resin over Resin | | | | | | | | | • |
| 3A (Aluminum Oxide) | Closed w/ Coolants | Resin over Resin | | | | | | | | | • |
| Z (Zirconium) | Closed | Resin over Resin | | | | | | | | | • |
| 3Z (Zirconium) | Closed w/ Coolants | Resin over Resin | | | | | | | | | • |
| C (Silicon Carbide) | Closed | Resin over Resin | | | | | | | | | • |
| Screens | | | | | | | | | | | |
| Silicon Carbide | N/A | Resin over Resin | Cloth screen impregnated with Silicon Carbide | • | • | • | • | | | • | |
| Non-Woven | | | | | | | | | | | |
| Aluminum Oxide/Silicon Carbide | N/A | N/A | Non woven nylon | • | | | | | | • | |
| Silicate Compounds | N/A | N/A | Non woven nylon | • | | | | | | | |
| Buffing Discs | N/A | N/A | Buffing Cloth | | | | | | | • | |
| Combination | | | | | | | | | | | |
| Silicon Carbide | Open/Closed | Resin over Glue | Paper/Cloth | | • | • | • | | | • | |

Index By Product Description

| Product Description | Page |
|---|--------------|
| .045 & .090 Thin High Speed Cut-Off Wheels | 28-34 |
| Accessory Items | 141-148 |
| Acid Brushes | 136 |
| Belts | 66, 69 |
| • Backstand | 66-69 |
| • Benchstand | 70 |
| • Custom | 111 |
| • Floor Sanding | 66-68 |
| • Portable | 118 |
| • Surface Conditioning | 61 |
| Bench Grinding Wheels | 162-163 |
| Bonded Abrasives Application Chart | 131, 137 |
| Brushes for Bench Grinders | 135, 137 |
| Brushes For Small Grinders | 128, 148 |
| Buffing Discs/Compounds | 138-139 |
| Carbide Burs/Wood Storage Box | 108-109 |
| Cartridge Rolls | 18 |
| Challenger II™ Wheels | 41-43 |
| Chop Saw Wheels | 164-165 |
| Coated Abrasives Application Chart | 19 |
| Cones & Plugs | 126 |
| Convolute Wheels | 57-58 |
| Cotton Fiber Grinding Wheels/Mounted Points | 59 |
| Cotton Fiber Laminated Discs/Cutting Wheels | 110 |
| Cross Pads | 131-132 |
| Cup Brushes | 20-21 |
| Cup Stones | 28-31 |
| Cutting Wheels | 32-34 |
| • .045 Type 27/Type 1 | 24-25, 37 |
| • .090 Type 27/Type 1 | 35-36 |
| • 1/8 inch Type 27 | 30-31, 38-39 |
| • 3/32 inch Type 27 | 54-55 |
| • Type 1 Thin High Speed Cut-Off | 135 |
| Diamond Wheels | 71-76 |
| End Brushes | 116, 122 |
| Fiber Discs | 92 |
| Flap Brushes, Non-woven | 91, 93-94 |
| Flap Discs | 90-91 |
| • General Purpose | 95-96 |
| • High Performance | 116, 123 |
| • Ovation® | 111-113 |
| Flap Wheels | 114-115 |
| • Coated | 8-14 |
| • Interleaf | 15-17 |
| Floor Sanding | 60 |
| • Coated | 116-117 |
| • Non-woven | 60 |
| Grinding Wheels | 60 |
| • 1/4 inch Type 27 | 116-117 |
| • 1/4 inch Type 28 | 116-117 |
| Hand & Floor Rubs | 60 |
| Hand Pad, 6x9 | 116-117 |

Index By Product Description

| Product Description | Page |
|---|---------------|
| Hook & Loop Discs | .84-85 |
| How to Use This Catalog | .4 |
| Knot Wire Wheels | .133-134 |
| Laminated Discs | .77-79 |
| Metal Chip Brush | .136 |
| Metal-Cutting Carbide Blades | .50-53 |
| Mounted Points | .22 |
| Nylon Abrasive Brushes | .137 |
| Paint Brushes | .136 |
| Pipeline Brushes | .133-134 |
| Pipeline Wheels - 1/8 inch Type 27 | .23-25 |
| Plumber Rolls | .106 |
| Portable Saw Cut-Off Wheels | .40, 44-46 |
| Products by Tool Index | .6 |
| Promotional Items/Point of Purchase Display | .149-151 |
| PSA Cloth Discs | .80, 86-87 |
| PSA Paper Discs | .80-83 |
| Safety Guide | .153 |
| SAITBLEND™ Wheels | .58 |
| SAIT-PAK™ | .140 |
| Saitscreen™ Rolls | .106 |
| SAIT-Strip™ | .116, 121 |
| Sanding Sponges | .103 |
| Scratch Brushes | .136 |
| Sheets | |
| • Cloth | .97-98 |
| • Drywall | .102 |
| • Fileboard | .100-101 |
| • Paper | .97-99 |
| • Saitscreen™ | .102 |
| Shop Rolls | .104-105 |
| Spiral Bands | .107 |
| Square Pads | .110 |
| Stationary Saw Cut-Off Wheels | .48-49 |
| Super-Lock Hub™ | .154 |
| Surface Conditioning Belts | .116, 118 |
| Surface Conditioning Discs | .116, 119-120 |
| Technical Info (Resin Bonded & Coated) | .155-161 |
| Thin High Speed Cut-Off Wheels | .30-31, 38-39 |
| Unitized Wheels/Type 27 | .116, 124-125 |
| Vitrified Mounted Points | .22 |
| Wire Brush - Concrete Expansion Joints | .135 |

Index By Product Number

| Number | Page | Number | Page |
|--------------|----------|--------------|--------|
| 00501-00516 | 136 | 21020-21099 | 15, 16 |
| 01401-01408 | 132 | 22000 | 35 |
| 01411 | 131 | 22005, 22007 | 24 |
| 02701-02714 | 135 | 22010 | 35 |
| 03373-03378 | 134 | 22011 | 28 |
| 03380 | 133, 134 | 22015 | 24 |
| 03381 | 133 | 22017 | 37 |
| 03382-03384 | 133, 134 | 22020 | 35 |
| 03385-03391 | 134 | 22021 | 28 |
| 03406-03423 | 131, 132 | 22025 | 37 |
| 03426-03461 | 133 | 22030, 22040 | 24 |
| 03501-03514 | 132 | 22041 | 37 |
| 04110-04390 | 137 | 22042 | 24 |
| 05751-05768 | 136 | 22045 | 35 |
| 06373-06391 | 133, 134 | 22046 | 24 |
| 06401-06423 | 131, 132 | 22047 | 28 |
| 06426-06461 | 133 | 22050, 22051 | 37 |
| 06501-06559 | 131, 132 | 22052 | 24 |
| 06701-06714 | 135 | 22053 | 28 |
| 09551-09560 | 131 | 22055 | 24 |
| 09570 | 135 | 22056, 22057 | 35 |
| 10006-16000 | 140 | 22060, 22061 | 37 |
| 20001-20013 | 8 | 22062 | 24 |
| 20014 | 13 | 22064 | 36 |
| 20015 | 8 | 22065 | 24 |
| 20017 | 14 | 22066, 22067 | 35 |
| 20018 | 11 | 22068 | 29 |
| 20019 | 8 | 22069 | 36 |
| 20041-20049 | 13 | 22070 | 35 |
| 20050, 20060 | 8 | 22071 | 28 |
| 20061 | 14 | 22072 | 29 |
| 20062 | 11 | 22073 | 29 |
| 20063 | 8 | 22074, 22079 | 36 |
| 20064 | 13 | 22082 | 29 |
| 20065, 20070 | 8 | 22084 | 36 |
| 20071 | 14 | 22088 | 29 |
| 20072 | 11 | 22089-22099 | 36 |
| 20073 | 8 | 22120 | 35 |
| 20074 | 13 | 22125 | 37 |
| 20075-20081 | 8 | 22130, 22140 | 24 |
| 20082 | 14 | 22141 | 37 |
| 20083 | 11 | 22170 | 35 |
| 20084 | 13 | 22264-22299 | 25 |
| 20085, 20086 | 8 | 22340-22370 | 28 |
| 20087 | 14 | 22599-22616 | 10 |
| 20088 | 11 | 22619-22636 | 25 |
| 20089 | 13 | 22640-22656 | 35 |
| 20090, 20091 | 8 | 23002-23075 | 39 |
| 20092 | 14 | 23099 | 30, 39 |
| 20093 | 11 | 23100 | 40 |
| 20094 | 13 | 23101 | 30, 38 |
| 20095, 20096 | 8 | 23102 | 40 |
| 20097 | 14 | 23103-23107 | 30, 38 |
| 20098 | 11 | 23140-23171 | 39 |
| 20099-20149 | 13 | 23172-23184 | 31 |
| 20150, 20160 | 8 | 23200-23211 | 38 |
| 20161 | 14 | 23222-23248 | 40 |
| 20162 | 11 | 23250-23253 | 38 |
| 20163 | 8 | 23254-23259 | 40 |
| 20164 | 13 | 23265-23278 | 38 |
| 20165, 20170 | 8 | 23304-23317 | 30 |
| 20171 | 14 | 23323-23337 | 29, 31 |
| 20172 | 11 | 23410, 23412 | 44, 45 |
| 20173 | 8 | 23413 | 46 |
| 20174 | 13 | 23415-23422 | 44, 45 |
| 20175-20295 | 8 | 23423 | 46 |
| 20902-20956 | 32, 33 | 23425-23450 | 44, 45 |
| 21000, 21001 | 15 | 23451 | 46 |
| 21002 | 17 | 23452- 23455 | 44, 45 |
| 21004, 21005 | 15 | 23456 | 46 |
| 21006 | 17 | 23457-23459 | 44, 45 |
| 21010, 21011 | 15 | 23460-23466 | 46 |
| 21012 | 17 | 23470-23502 | 44, 45 |
| 21014, 21015 | 15 | 23604-23606 | 30 |
| 21016 | 17 | 23654-23656 | 28 |
| | | 23703-23717 | 24 |

Index By Product Number

| Number | Page | Number | Page |
|--------------|----------|-------------|----------|
| 23803-23827 | 34 | 52320-52736 | 76, 77 |
| 24000-24007 | 48, 49 | 52810-53120 | 72 |
| 24010-24013 | 43 | 54016-54400 | 76 |
| 24020, 24023 | 48, 49 | 55215-55282 | 79 |
| 24030-24033 | 43 | 55342-55367 | 67, 68 |
| 24034 | 42 | 55420-55464 | 77 |
| 24035 | 43 | 56024-56120 | 72 |
| 24039 | 42 | 56215-56282 | 79 |
| 24040-24043 | 48, 49 | 56313-56353 | 75 |
| 24045 | 47 | 57016-57090 | 72 |
| 24050-24053 | 43 | 57100-57113 | 66 |
| 24060-24066 | 47 | 57120 | 72 |
| 24070-24102 | 48, 49 | 57200-58006 | 66-68 |
| 24120-24131 | 47 | 58016-58090 | 72 |
| 24135-24140 | 44 | 58111-58116 | 67 |
| 24145 | 47 | 58120 | 72 |
| 24150 | 44 | 58121-58206 | 67-69 |
| 24155 | 46 | 58224-58480 | 73 |
| 24160 | 44 | 58500-58506 | 67 |
| 24165 | 46 | 58524-58780 | 73 |
| 24210-24230 | 12 | 58850-58906 | 68, 69 |
| 24251-24254 | 31 | 59113-59153 | 75 |
| 24310-24330 | 37 | 59224-59980 | 73 |
| 24412-24416 | 43 | 60016-65112 | 65-69 |
| 24500 | 42 | 70001-71182 | 94, 95 |
| 25000-25008 | 19 | 72000-72053 | 96 |
| 25010-25062 | 60 | 73020-73493 | 94 |
| 25101-25306 | 19 | 73502-73506 | 92 |
| 25803-25819 | 9 | 73540-73680 | 94 |
| 26000-26063 | 20, 21 | 73685-73698 | 92 |
| 27010-27414 | 22 | 73702-73708 | 93 |
| 27500-27513 | 18 | 73714-73718 | 92 |
| 28000-28172 | 61 | 73736-73880 | 94 |
| 29200-29214 | 57 | 73890-73899 | 92 |
| 29270-29322 | 58, 59 | 73920-73982 | 93 |
| 34110-34175 | 83 | 74050-74072 | 95 |
| 34210-34627 | 85 | 74321-75780 | 93 |
| 34770-34778 | 100 | 76206-76361 | 91 |
| 34987-35241 | 86, 87 | 76420-76780 | 93 |
| 36500-36519 | 81 | 77115-77146 | 120 |
| 36520-36525 | 82 | 77162-77185 | 127 |
| 36540-36568 | 84 | 77200-77215 | 119 |
| 36600-36619 | 81 | 77230-77280 | 121 |
| 36620-36625 | 82 | 77300-77321 | 119 |
| 36640-36658 | 84 | 77325-77332 | 122 |
| 36800-36911 | 81 | 77350-77355 | 121 |
| 37082-37239 | 86, 87 | 77382-77395 | 127 |
| 37505-37511 | 82 | 77440-77496 | 117 |
| 37515-37563 | 84 | 77500-77577 | 118 |
| 37605-37610 | 82 | 77672-77685 | 127 |
| 37615-37651 | 84 | 77710-77756 | 123 |
| 37800-37909 | 81 | 77810-77825 | 126 |
| 38001-38346 | 108, 109 | 77830-77890 | 124, 125 |
| 41000-41057 | 128, 148 | 77920-77977 | 51, 52 |
| 42001-42054 | 107 | 78005-78151 | 91 |
| 45000-45693 | 139 | 80000 | 106 |
| 48001-48063 | 110 | 80405-82430 | 104, 105 |
| 48501-48768 | 54, 55 | 83110-83173 | 101 |
| 50000-50045 | 72 | 83205-83430 | 104 |
| 50050-50052 | 76 | 84051-84079 | 102 |
| 50060-50087 | 72 | 84089-84097 | 106 |
| 50100-50113 | 76 | 84101-84108 | 98 |
| 50120-50200 | 72, 73 | 84113-84185 | 100, 101 |
| 50208-50235 | 78 | 84200-84293 | 98, 99 |
| 50238-50262 | 74 | 84331-84380 | 100 |
| 50264-50284 | 78 | 84907-84918 | 98 |
| 50300-50311 | 59 | 85000-85056 | 111 |
| 50320-50334 | 77 | 85100-85237 | 112 |
| 50338-50359 | 75 | 85285-85289 | 111 |
| 50360-50368 | 57 | 85300-85407 | 113 |
| 50370-50533 | 75 | 86121-86204 | 114, 115 |
| 50560-50566 | 57 | 86355-86481 | 103 |
| 51022-51120 | 72 | 87131-88812 | 114, 115 |
| 51242-51375 | 74, 75 | 95000-99045 | 142-151 |
| 52100-52125 | 72 | 95046 | 139 |
| 52208-52284 | 78 | 99048-99220 | 142-151 |

EVERY order is



***From phone order to truck
United Abrasives continues to***



For those who need it **NOW**, United Abrasives gives each order immediate attention. From the moment you place your order with a friendly Customer Service Representative, to the time we load your completed order on the truck for shipment,

a **RUSH** delivery!



United Abrasives, Inc./SAIT is a privately held company that was established in 1970. Our relationship with SAIT, an Italian corporation founded in 1953, began as we first manufactured coated abrasive belts. By 1975 we had expanded our production to include bonded abrasives. The strong commitment between United Abrasives, Inc. and SAIT continues today.

We are well-known worldwide for *quality, consistency, and the highest levels of service*. We are one of the largest and leading manufacturers of abrasive products in the world. We only use premium materials. We demand consistent manufacturing operations and have the most rigorous quality control testing in the industry.

United Abrasives manufactures a full line of bonded abrasives: grinding wheels, cutting wheels, cup wheels, cones, plugs and a host of similar bonded products. We also manufacture a wide variety of sanding sheets, belts, rolls, flap discs, fiber and PSA discs. Plus, we offer a broad line of wire brushes, non-woven abrasives, precision diamond-cut Tungsten Carbide Burs, diamond wheels, and a full line of accessories.

in less than 10 minutes!
break the innovation barrier.

less than ten minutes have passed. Seem impossible? With our state-of-the-art shipping facility, United Abrasives fulfills your expectations of a first-class supplier - ***Immediate, Accurate, and Complete Shipments.***



United Abrasives, Inc. / SAIT Worldwide

North Windham, Connecticut



Torino, Italy



Piozzo, Italy

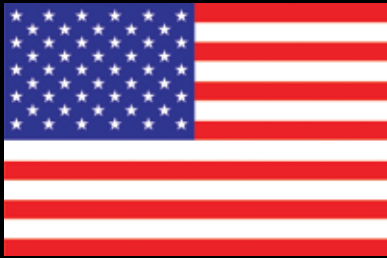

SAIT U.S.A.



SAIT Italy



SAIT Brazil



SAIT Canada



SAIT England

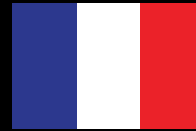

SAIT France



SAIT Spain

U.S. Headquarters
185 Boston Post Rd
North Windham, CT 06256
860.456.7131 • 800.428.5927

Salt Lake City Distribution Center
837 West 2600 South
South Salt Lake City, UT 84119

United Abrasives Canada, Inc.
1835 Meyerside Drive, Unit 3
Mississauga, Ontario L5T 1G4
800.345.7248

