

MaxGard® Interconnection Systems

In this section...



MaxGard® Interconnection Systems

Overview	8-12
Competitive Checklist and Catalog Numbering System.....	13
Load-Breaking Plugs, Receptacles and Connectors — 30 Amp.....	14-17
Load-Breaking Plugs, Receptacles and Connectors — 60 Amp.....	18-21
Load-Breaking Plugs, Receptacles and Connectors — 100 Amp.....	22-25
Load-Breaking Plugs, Receptacles and Connectors — 200 Amp.....	26-29
Load-Breaking Plugs, Receptacles and Connectors — 400 Amp.....	30-33
Accessories	34-37
Engineering Specifications	38-39
Voltage Selector.....	40
Dimensions.....	41-42
Industrial Interlocked Receptacles.....	43-49
GSUL Safe Ground Indicator System	50-52

Thomas & Betts

A Member of the ABB Group

MaxGard® Interconnection Systems

30A–400A (30–200A Load Breaking), Maximum 600VAC/250VDC
Receptacles, Inlets, Plugs, Connectors, Interlocked Receptacles, Explosion-Proof Interlocked Receptacles



Safety

- **Different power supply ratings can't mix:** 24 single-rate device polarizations ensure exact voltage, frequency and phase differentiation
- **Safe connections:** Safely connect and disconnect, even in the most extreme conditions such as heavy industrial and explosion-proof environments
- **Added safety measures:** Explosion-proof rating on all plugs
- **Plugs stay in:** Standard delayed-action pull-and-turn withdrawal offers all plugs an explosion-proof rating
- **Waterproof construction:** Standard O-ringed interior components provide environmental separation; watertight mated or unmated

Durability

- **Built for durability:** Rugged cast aluminum housings with an electrostatic epoxy coating are standard, along with stainless steel hardware
- **The best connections for life:** Pins and sleeves are made from Marine-grade CDA 485 brass; 200- and 400-amp pins and sleeves are silver plated

Performance

- **Foreign objects stay out:** All receptacles and connectors have a gated rotating disk (gated deadfront) on the face of the interior, which engages upon insertion
- **Any configuration you need:** Through 4-pole 5-wire configurations, all have a safety center earth ground pin design that makes first and breaks last
- **Ease of assembly:** Solderless pressure-type screw terminals with hex socket heads and rear-access, take-apart housings provide quick wiring access — no interior removal required for wiring receptacles and connectors
- **More control available:** Two optional pilot/control pins for contactors, load monitoring circuit, shunt trip or any other communication function you need
- **More power:** 150% non UL® rating enables MaxGard® installations to be extended up to 600-amp custom loads with separate disconnect service

MaxGard® Interconnection Systems

30A–400A (30–200A Load Breaking), Maximum 600VAC/250VDC Receptacles, Inlets, Plugs, Connectors, Interlocked Receptacles, Explosion-Proof Interlocked Receptacles

Plug and Receptacle with Angle Adapter and Junction Box

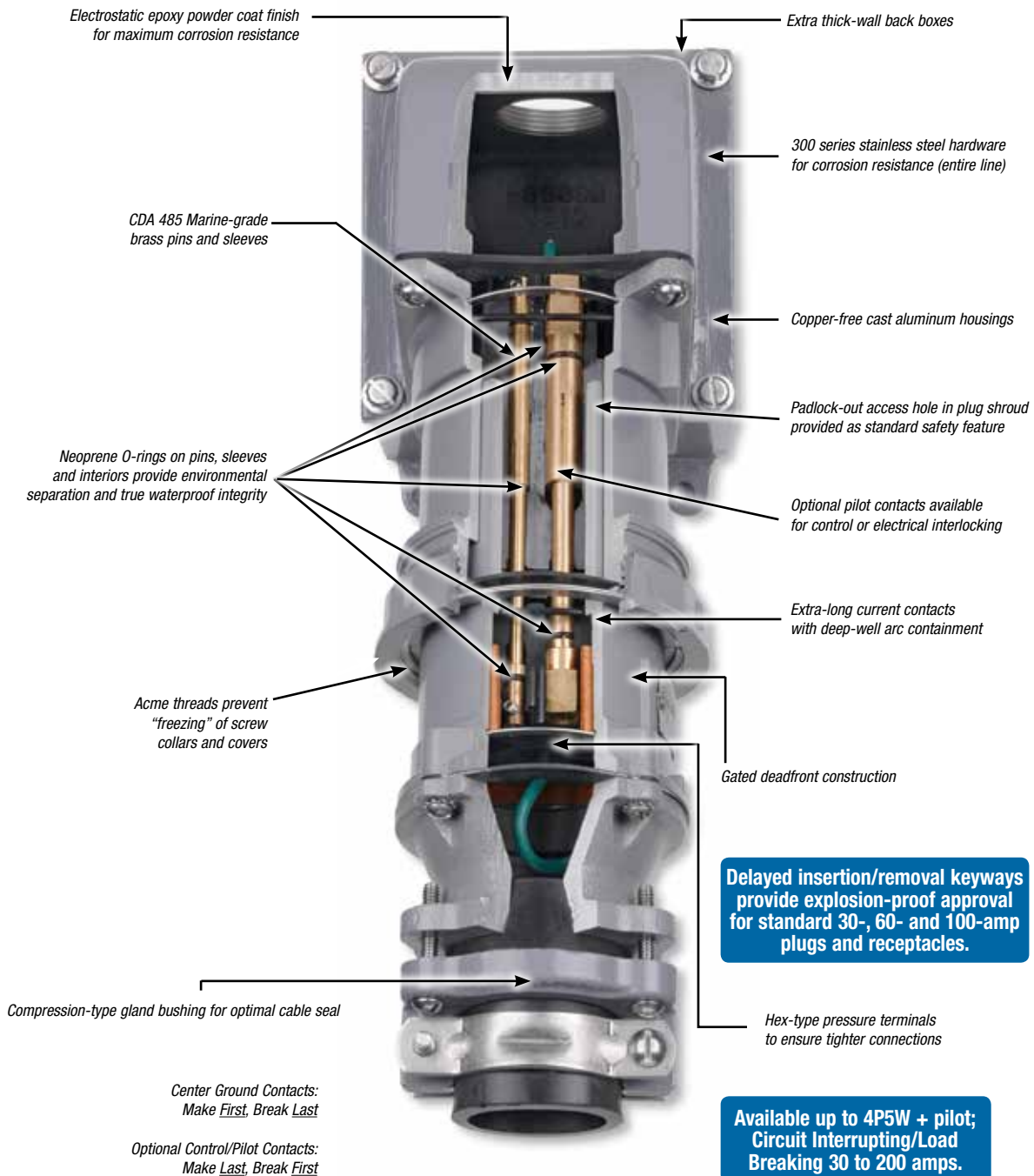

Russellstoll® Pin and Sleeve Power Connectors

MaxGard® Interconnection Systems

30A–400A (30–200A Load Breaking), Maximum 600VAC/250VDC Receptacles, Inlets, Plugs, Connectors, Interlocked Receptacles, Explosion-Proof Interlocked Receptacles

Cast Aluminum Circuit Breaker Interlocked Receptacle (Cutaway View)

Russellstoll® Pin and Sleeve Power Connectors

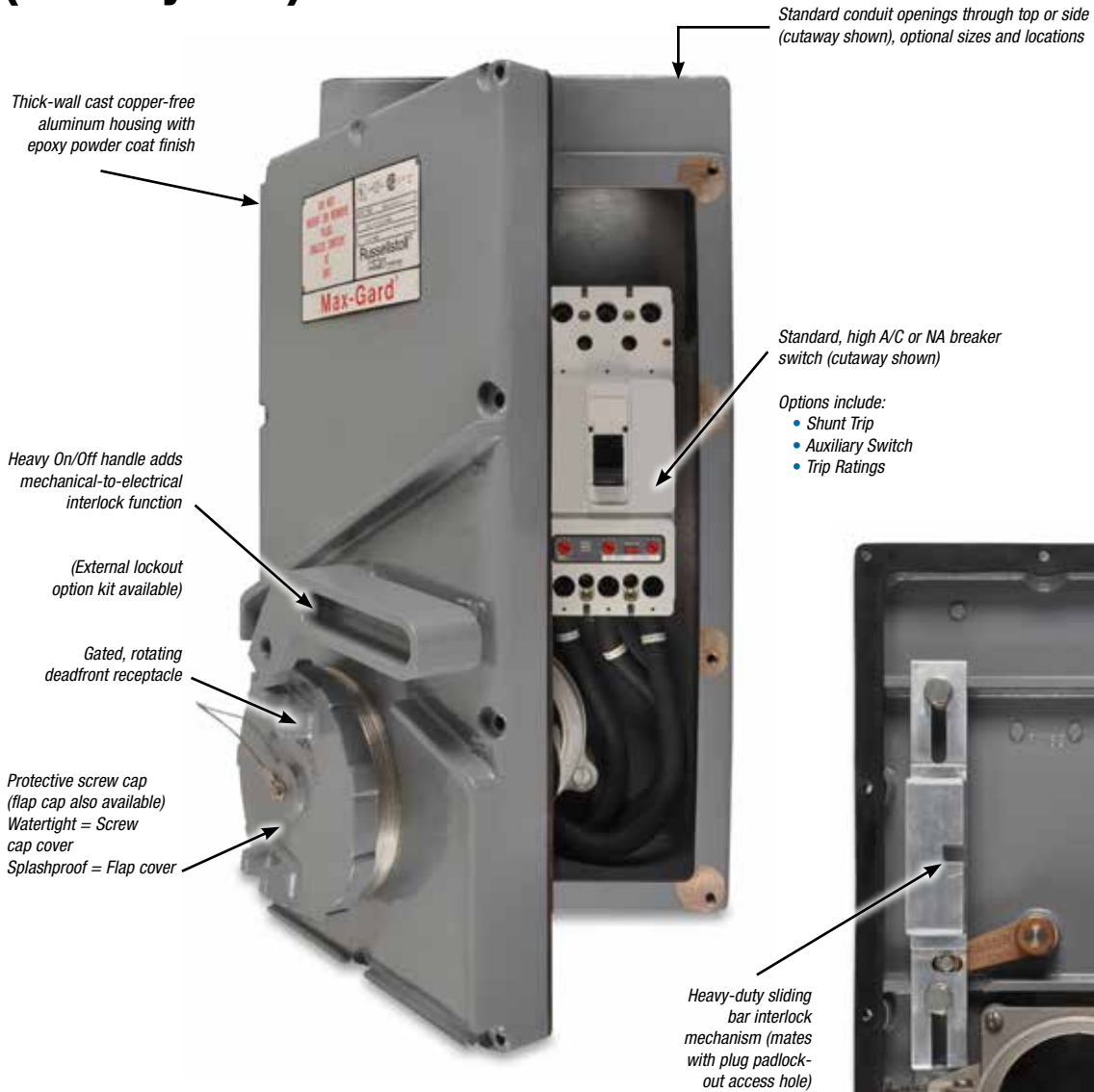

NEMA 4X interlocks available in 30–400-amp ranges through 4P5W, with 2 optional pilot/control contacts.

MaxGard® Interconnection Systems

30A–400A (30–200A Load Breaking), Maximum 600VAC/250VDC
 Receptacles, Inlets, Plugs, Connectors, Interlocked Receptacles, Explosion-Proof Interlocked Receptacles

Fused-Disconnect Switch* Interlocked Receptacle

Available in 30-, 60- and 100-amp sizes, all polarizations through 600VAC.

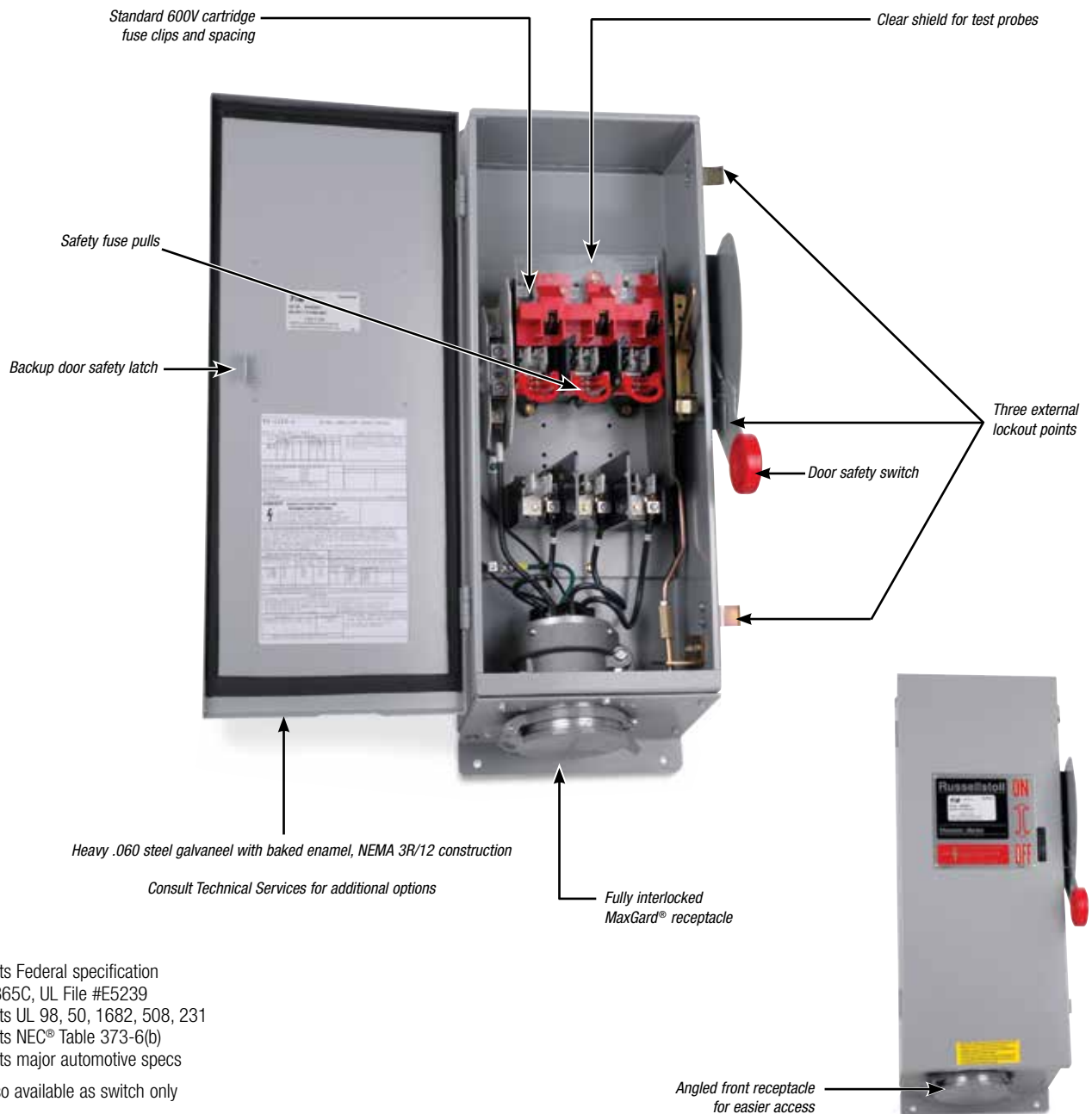

Meets Federal specification
 WS865C, UL File #E5239
 Meets UL 98, 50, 1682, 508, 231
 Meets NEC® Table 373-6(b)
 Meets major automotive specs

* Also available as switch only

Russellstoll® Pin and Sleeve Power Connectors

MaxGard® Interconnection Systems

30A–400A (30–200A Load Breaking), Maximum 600VAC/250VDC
 Receptacles, Inlets, Plugs, Connectors, Interlocked Receptacles, Explosion-Proof Interlocked Receptacles

MaxGard® DBRE and DSRE series interlocks are explosion proof and waterproof (O-ring sealed), along with optional control contacts, and are fully UL® Listed.

Explosion-Proof Waterproof Circuit Breaker Interlocked Receptacle

Available in 30-, 60- and 100-amp sizes, all polarizations.

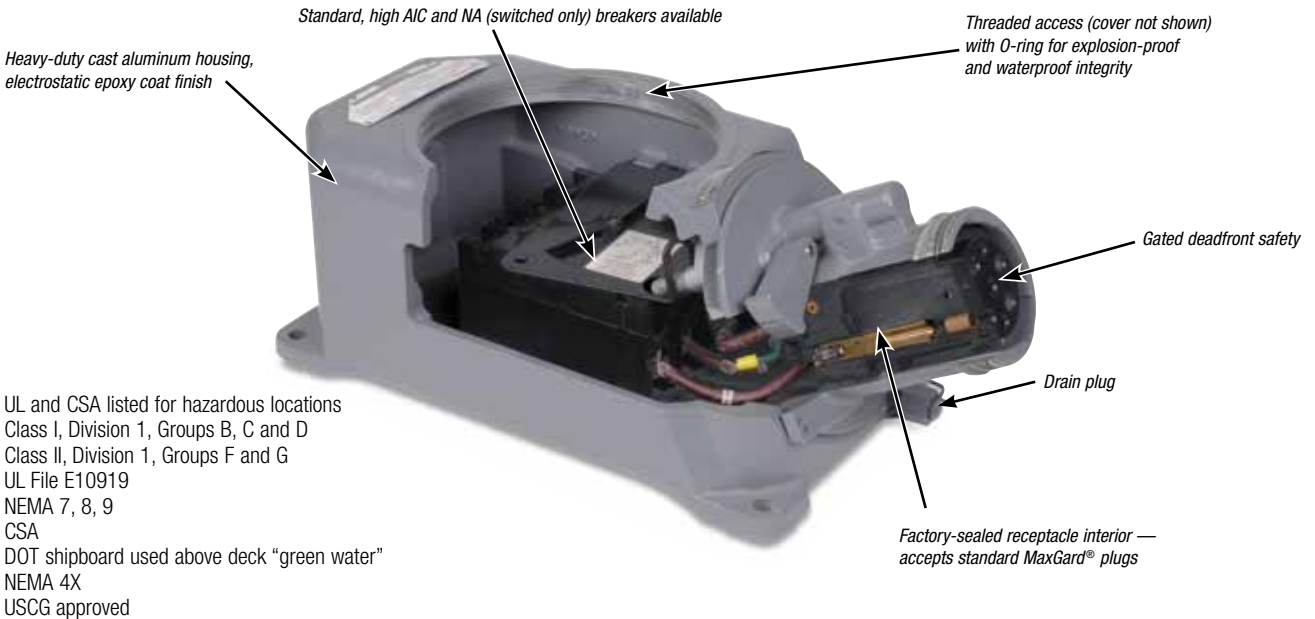

Explosion-Proof Waterproof Non-Interlocked Receptacle

Available in 30A 480VAC max, all polarizations

- Factory-sealed interior (no filled conduits)
- Easy low-cost installation



MaxGard® Interconnection Systems

30A–400A Plugs, Connectors, Receptacles, Inlets and Interlocked Receptacles

Receptacles, Plugs and Connectors

FEATURE	RUSSELLSTOLL MAXGARD®	CROUSE-HINDS ARKTITE®**	APPLETON POWERTITE®***
Center ground contact	Yes	No	No
24 single-rated factory polarizations	Yes	No	No
Gated deadfront construction	Yes	No	No
Two optional control contacts	Yes	No	No
Marine-grade CDA485 brass pins/sleeves (200–400 amp silver-plated)	Yes	No	No
O-rings/environmental separation, full line	Yes	No	No
Available to 5-wire (4-pole, 5-wire)	Yes	30 and 60 amp only	No
Complete line epoxy powder coated — standard	Yes	No	Some

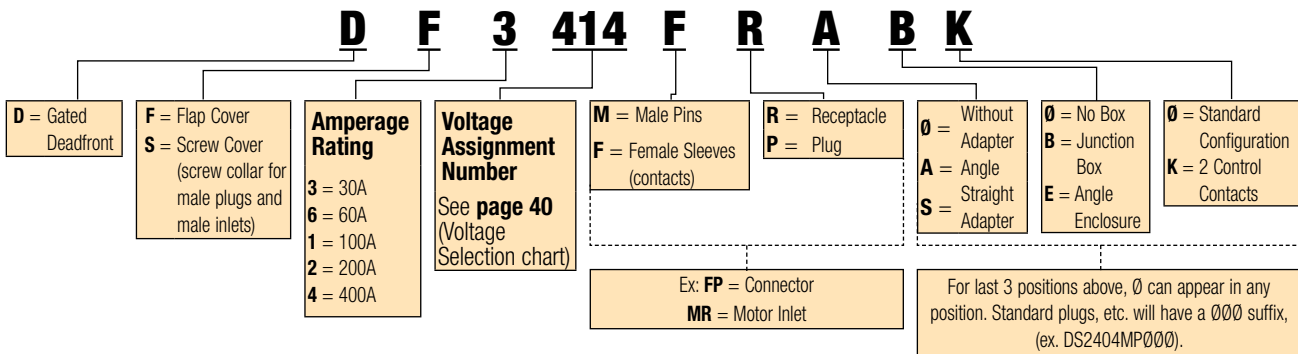

Interlocked Receptacles

FEATURE	RUSSELLSTOLL DBRE/DSRE SERIES	CROUSE-HINDS EPC SERIES	APPLETON EBR SERIES (WITH FB BREAKER)
Waterproof (DurORing™) O-ring sealing	Yes	No	No
Available to 5-wire (4-pole, 5-wire) through 100 amp	Yes	No	No
Gated deadfront	Yes	No	No
Center ground sleeve contact	Yes	No	No
24 single-rated factory polarizations	Yes	No	No
Class I, Div. 1, Groups B, C, D	Yes	Yes	Yes
Class II, Div. 1, Groups F and G	Yes	Yes	Yes*
Meets Coast Guard (was CG259) approvals	Yes	No	No

* Group F excepting electrically conductive dusts. ** Crouse-Hinds and Arktite are trademarks of Cooper Industries, Inc. *** Appleton and Powertite are trademarks of Appleton Electric Inc.

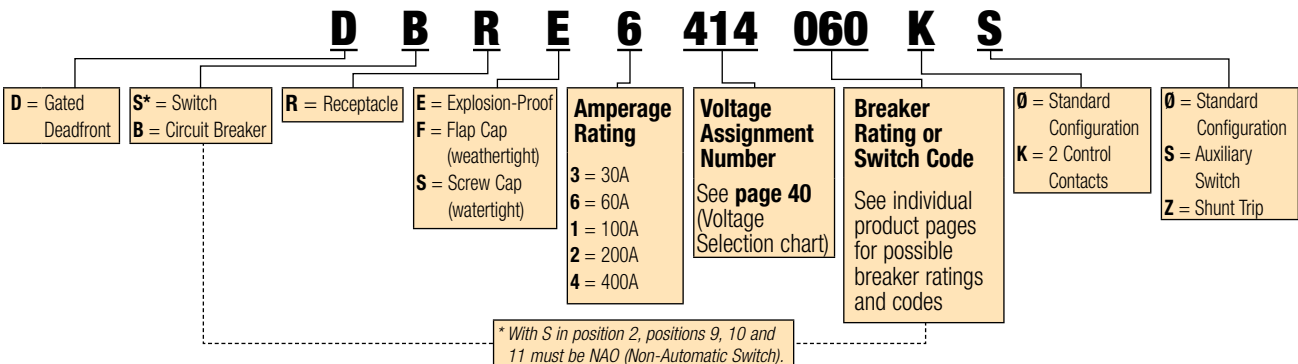

MaxGard® Interconnection Systems

30 Amp Standard Service

** If receptacle is desired with a Straight Adapter instead of standard Angle Adapter, substitute "S" for the "A" in the catalog number of the Receptacle with Angle Adapter or Adapter and Box.

† Standard cable bushings shown; see **page 34** for other sizes available at no extra cost if specified on order.

†† Always furnished with screw collar. We recommend cup cap with male plug; order catalog number DS3CC.

Maximum lug wire 8 AWG 7-strand or flexible, cable entrance .187" diameter.

Receptacles furnished with flap cap also have screw thread to accept male collar on plug.

Catalog numbers shown are for flap cap receptacles; change "DF" to "DS" for ordering screw cap.

Boldface figures are for voltage assignment.

For different ratings, see **page 40**.

Outlet furnished at location "B" unless otherwise specified. 1" NPT.

▼ **Control contacts for plug/receptacles:**
Use "K" where noted. Ex: DS3104MP00K

For Adapters, Junction Boxes and Accessories, see **pages 34–37**.

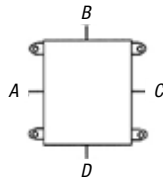

Male Plug††

Female Connector

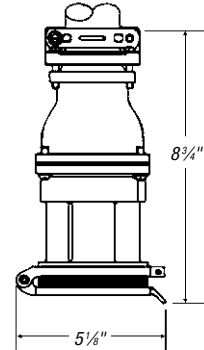
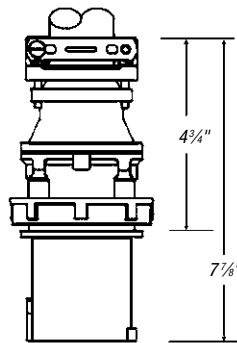

Device Ratings and Polarizations

Maximum 600VAC or 250VDC

(For full polarization, see **page 40**)

POLE	WIRE	CONDUCTOR PLACEMENT	VOLTAGE 60 HZ	CAT. NO.	STANDARD BUSHING I.D.†	CAT. NO.	STANDARD BUSHING I.D.†
2	3		277	DS3104MP000	7/8"	DF3104FP000	7/8"
			125	DS3107MP000		DF3107FP000	
2	3		480	DS3204MP000	7/8"	DF3204FP000	7/8"
			250	DS3207MP000		DF3207FP000	
			600	DS3214MP000		DF3214FP000	
			208	DS3216MP000		DF3216FP000	
3	4		277/480	DS3304MP000	1"	DF3304FP000	1"
			125/250	DS3307MP000		DF3307FP000	
			120/208	DS3316MP000		DF3316FP000	
3	4		3Ø 480	DS3404MP000	1"	DF3404FP000	1"
			3Ø 250	DS3407MP000		DF3407FP000	
			3Ø 600	DS3414MP000		DF3414FP000	
			3Ø 208	DS3416MP000		DF3416FP000	
			3Ø 440	DS3421MP000		DF3421FP000	
4	5		3ØY 277/480	DS3504MP000	1 1/16"	DF3504FP000	1 1/16"
			3ØY 347/600	DS3514MP000		DF3514FP000	
			3ØY 120/208	DS3516MP000		DF3516FP000	
			3ØY 250/440	DS3521MP000		DF3521FP000	

MaxGard® Interconnection Systems



Female Receptacle with Angle Enclosure



Female Receptacle with Angle Adapter** and Junction Box



Female Receptacle with Angle Adapter**



Female Receptacle

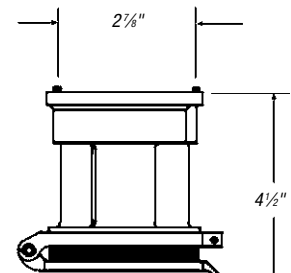
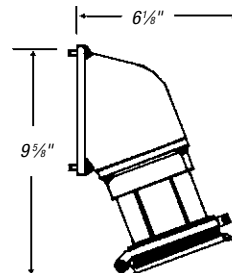
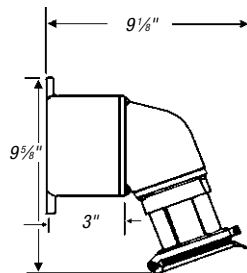
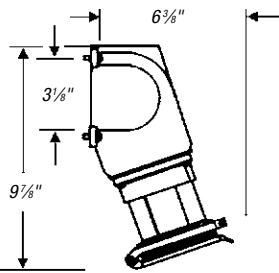

CAT. NO.	CAT. NO.	CAT. NO.	CAT. NO.
DF3104FR0E0	DF3104FRAB0	DF3104FRA00	DF3104FR000
DF3107FR0E0	DF3107FRAB0	DF3107FRA00	DF3107FR000
DF3204FR0E0	DF3204FRAB0	DF3204FRA00	DF3204FR000
DF3207FR0E0	DF3207FRAB0	DF3207FRA00	DF3207FR000
DF3214FR0E0	DF3214FRAB0	DF3214FRA00	DF3214FR000
DF3216FR0E0	DF3216FRAB0	DF3216FRA00	DF3216FR000
DF3304FR0E0	DF3304FRAB0	DF3304FRA00	DF3304FR000
DF3307FR0E0	DF3307FRAB0	DF3307FRA00	DF3307FR000
DF3316FR0E0	DF3316FRAB0	DF3316FRA00	DF3316FR000
DF3404FR0E0	DF3404FRAB0	DF3404FRA00	DF3404FR000
DF3407FR0E0	DF3407FRAB0	DF3407FRA00	DF3407FR000
DF3414FR0E0	DF3414FRAB0	DF3414FRA00	DF3414FR000
DF3416FR0E0	DF3416FRAB0	DF3416FRA00	DF3416FR000
DF3421FR0E0	DF3421FRAB0	DF3421FRA00	DF3421FR000
DF3504FR0E0	DF3504FRAB0	DF3504FRA00	DF3504FR000
DF3514FR0E0	DF3514FRAB0	DF3514FRA00	DF3514FR000
DF3516FR0E0	DF3516FRAB0	DF3516FRA00	DF3516FR000
DF3521FR0E0	DF3521FRAB0	DF3521FRA00	DF3521FR000

MaxGard® Interconnection Systems

30 Amp Reverse Service

** If receptacle is desired with a Straight Adapter instead of standard Angle Adapter, substitute "S" for the "A" in the catalog number of the Receptacle with Angle Adapter or Adapter and Box.

† Standard cable bushings shown; see **page 34** for other sizes available at no extra cost if specified on order.

†† Always furnished with screw collar. We recommend cup cap with male plug; order catalog number DS3CC.

Maximum lug wire 4 AWG 7-strand or flexible, cable entrance .187" diameter.

Receptacles furnished with flap cap also have screw thread to accept male collar on plug.

Catalog numbers shown are for flap cap receptacles; change "DF" to "DS" for ordering screw cap.

Boldface figures are for voltage assignment. For different ratings, see **page 40**.

Outlet furnished at location "B" unless otherwise specified. 1" NPT.

▼ **Control contacts for plug/receptacles:**
Use "K" where noted. Ex: DS3104MR00K

For Adapters, Junction Boxes and Accessories, see **pages 34–37**.

Device Ratings and Polarizations

Maximum 600VAC or 250VDC

(For full polarization, see **page 40**)

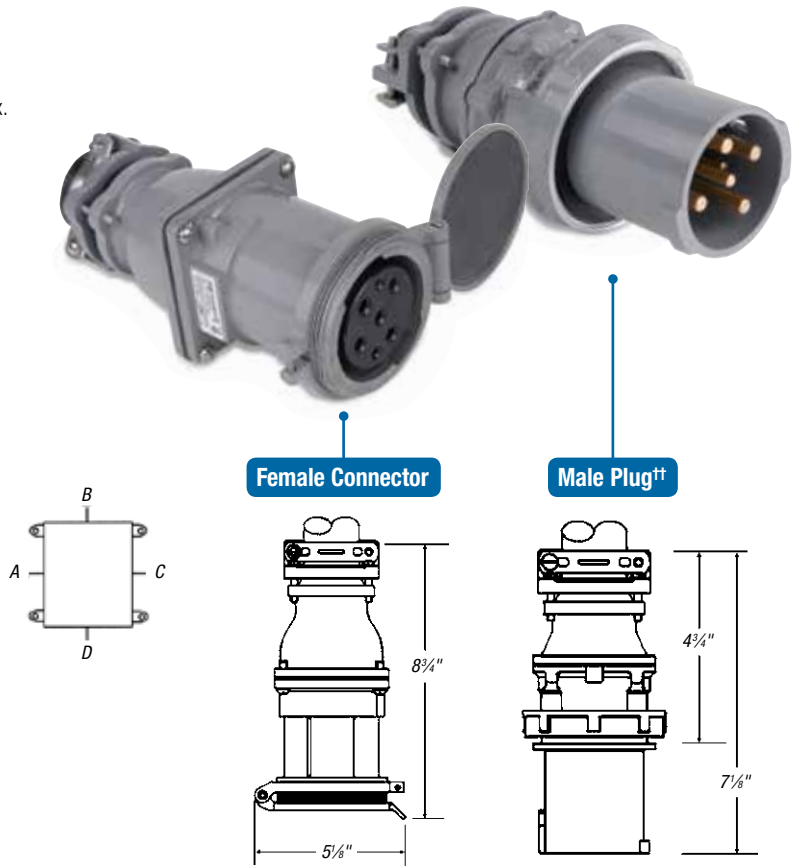

POLE	WIRE	CONDUCTOR PLACEMENT	VOLTAGE 60 HZ	CAT. NO.	STANDARD BUSHING I.D.†	CAT. NO.	STANDARD BUSHING I.D.†
2	3		277	DF3104FP000	7/8"	DS3104MP000	7/8"
			125	DF3107FP000		DS3107MP000	
2	3		480	DF3204FP000	7/8"	DS3204MP000	7/8"
			250	DF3207FP000		DS3207MP000	
			600	DF3214FP000		DS3214MP000	
			208	DF3216FP000		DS3216MP000	
3	4		277/480	DF3304FP000	1"	DS3304MP000	1"
			125/250	DF3307FP000		DS3307MP000	
			120/208	DF3316FP000		DS3316MP000	
3	4		3Ø 480	DF3404FP000	1"	DS3404MP000	1"
			3Ø 250	DF3407FP000		DS3407MP000	
			3Ø 600	DF3414FP000		DS3414MP000	
			3Ø 208	DF3416FP000		DS3416MP000	
			3Ø 440	DF3421FP000		DS3421MP000	
4	5		3ØY 277/480	DF3504FP000	1 1/16"	DS3504MP000	1 1/16"
			3ØY 347/600	DF3514FP000		DS3514MP000	
			3ØY 120/208	DF3516FP000		DS3516MP000	
			3ØY 250/440	DF3521FP000		DS3521MP000	

MaxGard® Interconnection Systems



Male Inlet with Angle Enclosure

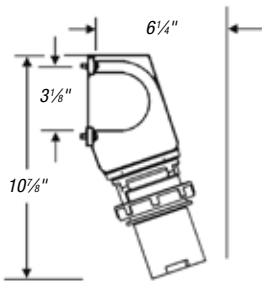

Male Inlet with Angle Adapter** and Junction Box

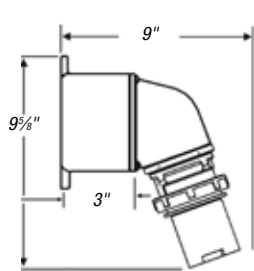

Male Inlet with Angle Adapter**

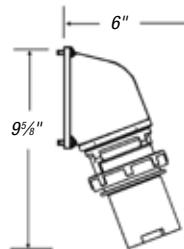

Male Inlet††

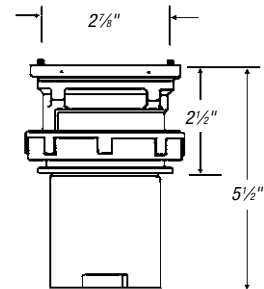

CAT. NO.	CAT. NO.	CAT. NO.	CAT. NO.
DS3104MR0E0	DS3104MRAB0	DS3104MRA00	DS3104MR000
DS3107MR0E0	DS3107MRAB0	DS3107MRA00	DS3107MR000
DS3204MR0E0	DS3204MRAB0	DS3204MRA00	DS3204MR000
DS3207MR0E0	DS3207MRAB0	DS3207MRA00	DS3207MR000
DS3214MR0E0	DS3214MRAB0	DS3214MRA00	DS3214MR000
DS3216MR0E0	DS3216MRAB0	DS3216MRA00	DS3216MR000
DS3304MR0E0	DS3304MRAB0	DS3304MRA00	DS3304MR000
DS3307MR0E0	DS3307MRAB0	DS3307MRA00	DS3307MR000
DS3316MR0E0	DS3316MRAB0	DS3316MRA00	DS3316MR000
DS3404MR0E0	DS3404MRAB0	DS3404MRA00	DS3404MR000
DS3407MR0E0	DS3407MRAB0	DS3407MRA00	DS3407MR000
DS3414MR0E0	DS3414MRAB0	DS3414MRA00	DS3414MR000
DS3416MR0E0	DS3416MRAB0	DS3416MRA00	DS3416MR000
DS3421MR0E0	DS3421MRAB0	DS3421MRA00	DS3421MR000
DS3504MR0E0	DS3504MRAB0	DS3504MRA00	DS3504MR000
DS3514MR0E0	DS3514MRAB0	DS3514MRA00	DS3514MR000
DS3516MR0E0	DS3516MRAB0	DS3516MRA00	DS3516MR000
DS3521MR0E0	DS3521MRAB0	DS3521MRA00	DS3521MR000

MaxGard® Interconnection Systems

60 Amp Standard Service

** If receptacle is desired with a Straight Adapter instead of standard Angle Adapter, substitute "S" for the "A" in the catalog number of the Receptacle with Angle Adapter or Adapter and Box.

† Standard cable bushings shown; see **page 34** for other sizes available at no extra cost if specified on order.

†† Always furnished with screw collar. We recommend cup cap with male plug; order catalog number DS6CC.

Maximum lug wire 4 AWG 7-strand or flexible, cable entrance .302" diameter.

Receptacles furnished with flap cap also have screw thread to accept male collar on plug.

Catalog numbers shown are for flap cap receptacles; change "DF" to "DS" for ordering screw cap.

Boldface figures are for voltage assignment. For different ratings, see **page 40**.

Outlet furnished at location "B" unless otherwise specified. 1½" NPT.

▼ **Control contacts for plug/receptacles:**
Use "K" where noted. Ex: DS6104MP00K

For Adapters, Junction Boxes and Accessories, see **pages 34–37**.

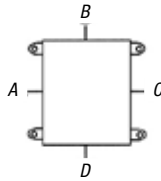

Male Plug††

Female Connector

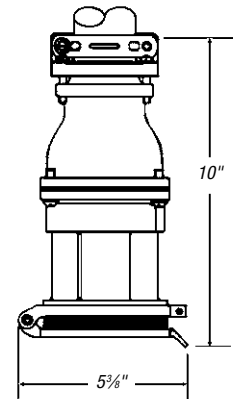
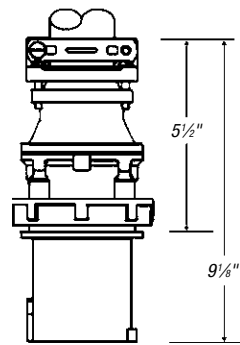

Device Ratings and Polarizations

Maximum 600VAC or 250VDC

(For full polarization, see **page 40**)

POLE	WIRE	CONDUCTOR PLACEMENT	VOLTAGE 60 HZ	CAT. NO.	STANDARD BUSHING I.D. †	CAT. NO.	STANDARD BUSHING I.D. †
2	3		277	DS6104MP000	1 3/16"	DF6104FP000	1 3/16"
			125	DS6107MP000		DF6107FP000	
2	3		480	DS6204MP000	1 3/16"	DF6204FP000	1 3/16"
			250	DS6207MP000		DF6207FP000	
			600	DS6214MP000		DF6214FP000	
			208	DS6216MP000		DF6216FP000	
3	4		277/480	DS6304MP000	1 3/16"	DF6304FP000	1 3/16"
			125/250	DS6307MP000		DF6307FP000	
			120/208	DS6316MP000		DF6316FP000	
3	4		3Ø 480	DS6404MP000	1 3/16"	DF6404FP000	1 3/16"
			3Ø 250	DS6407MP000		DF6407FP000	
			3Ø 600	DS6414MP000		DF6414FP000	
			3Ø 208	DS6416MP000		DF6416FP000	
			3Ø 440	DS6421MP000		DF6421FP000	
4	5		3ØY 277/480	DS6504MP000	1 1/2"	DF6504FP000	1 1/2"
			3ØY 347/600	DS6514MP000		DF6514FP000	
			3ØY 110/208	DS6516MP000		DF6516FP000	
			3ØY 250/440	DS6521MP000		DF6521FP000	

MaxGard® Interconnection Systems

Russellstoll® Pin and Sleeve Power Connectors



Female Receptacle with Angle Enclosure

Female Receptacle with Angle Adapter and Junction Box**

Female Receptacle with Angle Adapter**

Female Receptacle

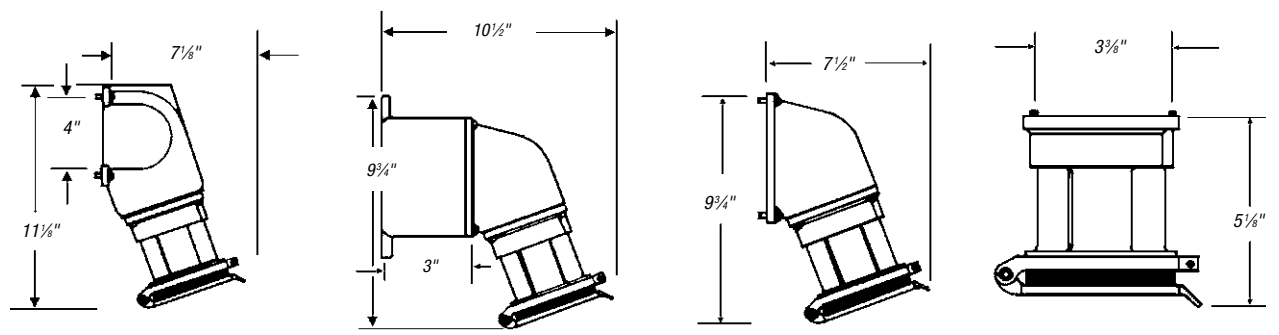

CAT. NO.	CAT. NO.	CAT. NO.	CAT. NO.
DF6104FR0E0	DF6104FRAB0	DF6104FRA00	DF6104FR000
DF6107FR0E0	DF6107FRAB0	DF6107FRA00	DF6107FR000
DF6204FR0E0	DF6204FRAB0	DF6204FRA00	DF6204FR000
DF6207FR0E0	DF6207FRAB0	DF6207FRA00	DF6207FR000
DF6214FR0E0	DF6214FRAB0	DF6214FRA00	DF6214FR000
DF6216FR0E0	DF6216FRAB0	DF6216FRA00	DF6216FR000
DF6304FR0E0	DF6304FRAB0	DF6304FRA00	DF6304FR000
DF6307FR0E0	DF6307FRAB0	DF6307FRA00	DF6307FR000
DF6316FR0E0	DF6316FRAB0	DF6316FRA00	DF6316FR000
DF6404FR0E0	DF6404FRAB0	DF6404FRA00	DF6404FR000
DF6407FR0E0	DF6407FRAB0	DF6407FRA00	DF6407FR000
DF6414FR0E0	DF6414FRAB0	DF6414FRA00	DF6414FR000
DF6416FR0E0	DF6416FRAB0	DF6416FRA00	DF6416FR000
DF6421FR0E0	DF6421FRAB0	DF6421FRA00	DF6421FR000
DF6504FR0E0	DF6504FRAB0	DF6504FRA00	DF6504FR000
DF6514FR0E0	DF6514FRAB0	DF6514FRA00	DF6514FR000
DF6516FR0E0	DF6516FRAB0	DF6516FRA00	DF6516FR000
DF6521FR0E0	DF6521FRAB0	DF6521FRA00	DF6521FR000

MaxGard® Interconnection Systems

60 Amp Reverse Service

** If receptacle is desired with a Straight Adapter instead of standard Angle Adapter, substitute "S" for the "A" in the catalog number of the Receptacle with Angle Adapter or Adapter and Box.

† Standard cable bushings shown; see **page 34** for other sizes available at no extra cost if specified on order.

†† Always furnished with screw collar. We recommend cup cap with male plug; order catalog number DS6CC.

Maximum lug wire 4 AWG 7-strand or flexible, cable entrance .302" diameter.

Receptacles furnished with flap cap also have screw thread to accept male collar on plug.

Catalog numbers shown are for flap cap receptacles; change "DF" to "DS" for ordering screw cap.

Boldface figures are for voltage assignment.

For different ratings, see **page 40**.

Outlet furnished at location "B" unless otherwise specified. 1½" NPT.

▼ **Control contacts for plug/receptacles:**
Use "K" where noted. Ex: DS3104MP00K

For Adapters, Junction Boxes and Accessories, see **pages 34–37**.

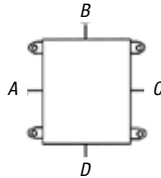

Female Connector

Male Plug††

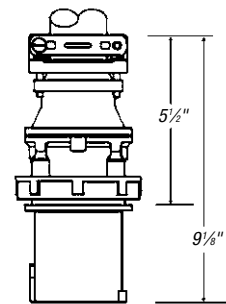
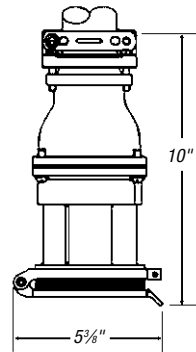

Device Ratings and Polarizations

Maximum 600VAC or 250VDC

(For full polarization, see **page 40**)

POLE	WIRE	CONDUCTOR PLACEMENT	VOLTAGE 60 HZ	CAT. NO.	STANDARD BUSHING I.D.†	CAT. NO.	STANDARD BUSHING I.D.†
2	3		277	DF6104FP000	1 3/16"	DS6104MP000	1 3/16"
			125	DF6107FP000		DS6107MP000	
2	3		480	DF6204FP000	1 3/16"	DS6204MP000	1 3/16"
			250	DF6207FP000		DS6207MP000	
			600	DF6214FP000		DS6214MP000	
			208	DF6216FP000		DS6216MP000	
3	4		277/480	DF6304FP000	1 3/16"	DS6304MP000	1 3/16"
			125/250	DF6307FP000		DS6307MP000	
			120/208	DF6316FP000		DS6316MP000	
3	4		3Ø 480	DF6404FP000	1 3/16"	DS6404MP000	1 3/16"
			3Ø 250	DF6407FP000		DS6407MP000	
			3Ø 600	DF6414FP000		DS6414MP000	
			3Ø 208	DF6416FP000		DS6416MP000	
			3Ø 440	DF6421FP000		DS6421MP000	
4	5		3ØY 277/480	DF6504FP000	1 1/2"	DS6504MP000	1 1/2"
			3ØY 347/600	DF6514FP000		DS6514MP000	
			3ØY 120/208	DF6516FP000		DS6516MP000	
			3ØY 250/440	DF6521FP000		DS6521MP000	

MaxGard® Interconnection Systems



Male Inlet with Angle Enclosure

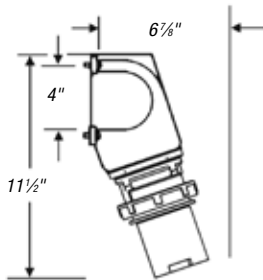

Male Inlet with Angle Adapter** and Junction Box

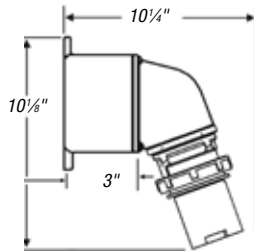

Male Inlet with Angle Adapter**

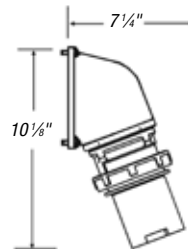

Male Inlet**

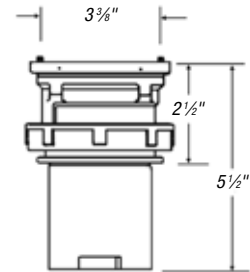

CAT. NO.	CAT. NO.	CAT. NO.	CAT. NO.
DS6104MR0E0	DS6104MRAB0	DS6104MRA00	DS6104MR000
DS6107MR0E0	DS6107MRAB0	DS6107MRA00	DS6107MR000
DS6204MR0E0	DS6204MRAB0	DS6204MRA00	DS6204MR000
DS6207MR0E0	DS6207MRAB0	DS6207MRA00	DS6207MR000
DS6214MR0E0	DS6214MRAB0	DS6214MRA00	DS6214MR000
DS6216MR0E0	DS6216MRAB0	DS6216MRA00	DS6216MR000
DS6304MR0E0	DS6304MRAB0	DS6304MRA00	DS6304MR000
DS6307MR0E0	DS6307MRAB0	DS6307MRA00	DS6307MR000
DS6316MR0E0	DS6316MRAB0	DS6316MRA00	DS6316MR000
DS6404MR0E0	DS6404MRAB0	DS6404MRA00	DS6404MR000
DS6407MR0E0	DS6407MRAB0	DS6407MRA00	DS6407MR000
DS6414MR0E0	DS6414MRAB0	DS6414MRA00	DS6414MR000
DS6416MR0E0	DS6416MRAB0	DS6416MRA00	DS6416MR000
DS6421MR0E0	DS6421MRAB0	DS6421MRA00	DS6421MR000
DS6504MR0E0	DS6504MRAB0	DS6504MRA00	DS6504MR000
DS6514MR0E0	DS6514MRAB0	DS6514MRA00	DS6514MR000
DS6516MR0E0	DS6516MRAB0	DS6516MRA00	DS6516MR000
DS6521MR0E0	DS6521MRAB0	DS6521MRA00	DS6521MR000

MaxGard® Interconnection Systems

100 Amp Standard Service

** If receptacle is desired with a Straight Adapter instead of standard Angle Adapter, substitute "S" for the "A" in the catalog number of the Receptacle with Angle Adapter or Adapter and Box.

† Standard cable bushings shown; see **page 34** for other sizes available at no extra cost if specified on order.

†† Always furnished with screw collar. We recommend cup cap with male plug; order catalog number DS1CC.

Maximum lug wire 0 AWG 19-strand or 1 AWG flexible, cable entrance .386" diameter.

Receptacles furnished with flap cap also have screw thread to accept male collar on plug.

Catalog numbers shown are for flap cap receptacles; change "DF" to "DS" for ordering screw cap.

Boldface figures are for voltage assignment. For different ratings, see **page 40**.

Outlet furnished at location "B" unless otherwise specified. 2" NPT.

▼ **Control contacts for plug/receptacles:**
Use "K" where noted. Ex: **DS1104MP00K**

For Adapters, Junction Boxes and Accessories, see **pages 34-37**.

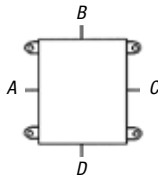

Male Plug††

Female Connector

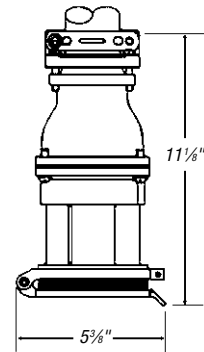
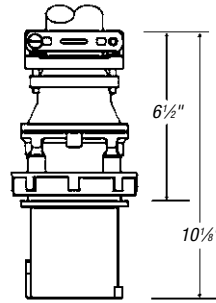

Device Ratings and Polarizations

Maximum 600VAC or 250VDC

(For full polarization, see **page 40**)

POLE	WIRE	CONDUCTOR PLACEMENT	VOLTAGE 60HZ	CAT. NO.	STANDARD BUSHING I.D. †	CAT. NO.	STANDARD BUSHING I.D. †
2	3		277	DS1104MP000	1 1/16"	DF1104FP000	1 1/16"
			125	DS1107MP000		DF1107FP000	
2	3		480	DS1204MP000	1 1/16"	DF1204FP000	1 1/16"
			250	DS1207MP000		DF1207FP000	
			600	DS1214MP000		DF1214FP000	
			208	DS1216MP000		DF1216FP000	
3	4		277/480	DS1304MP000	1 13/16"	DF1304FP000	1 13/16"
			125/250	DS1307MP000		DF1307FP000	
			120/208	DS1316MP000		DF1316FP000	
3	4		30 480	DS1404MP000	1 13/16"	DF1404FP000	1 13/16"
			30 250	DS1407MP000		DF1407FP000	
			30 600	DS1414MP000		DF1414FP000	
			30 208	DS1416MP000		DF1416FP000	
			30 440	DS1421MP000		DF1421FP000	
4	5		30Y 277/480	DS1504MP000	2"	DF1504FP000	2"
			30Y 347/600	DS1514MP000		DF1514FP000	
			30Y 118/208	DS1516MP000		DF1516FP000	
			30Y 250/440	DS1521MP000		DF1521FP000	

MaxGard® Interconnection Systems



Female Receptacle with Angle Enclosure



Female Receptacle with Angle Adapter** and Junction Box



Female Receptacle with Angle Adapter**



Female Receptacle

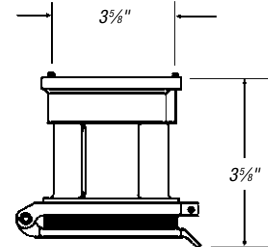
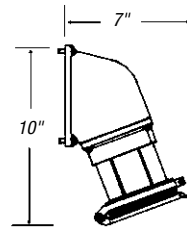
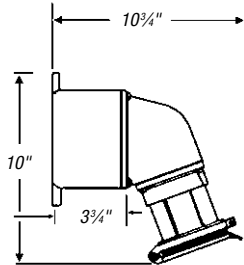
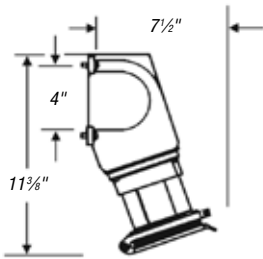

CAT. NO.	CAT. NO.	CAT. NO.	CAT. NO.
DF1104FR0E0	DF1104FRAB0	DF1104FRA00	DF1104FR000
DF1107FR0E0	DF1107FRAB0	DF1107FRA00	DF1107FR000
DF1204FR0E0	DF1204FRAB0	DF1204FRA00	DF1204FR000
DF1207FR0E0	DF1207FRAB0	DF1207FRA00	DF1207FR000
DF1214FR0E0	DF1214FRAB0	DF1214FRA00	DF1214FR000
DF1216FR0E0	DF1216FRAB0	DF1216FRA00	DF1216FR000
DF1304FR0E0	DF1304FRAB0	DF1304FRA00	DF1304FR000
DF1307FR0E0	DF1307FRAB0	DF1307FRA00	DF1307FR000
DF1316FR0E0	DF1316FRAB0	DF1316FRA00	DF1316FR000
DF1404FR0E0	DF1404FRAB0	DF1404FRA00	DF1404FR000
DF1407FR0E0	DF1407FRAB0	DF1407FRA00	DF1407FR000
DF1414FR0E0	DF1414FRAB0	DF1414FRA00	DF1414FR000
DF1416FR0E0	DF1416FRAB0	DF1416FRA00	DF1416FR000
DF1421FR0E0	DF1421FRAB0	DF1421FRA00	DF1421FR000
DF1504FR0E0	DF1504FRAB0	DF1504FRA00	DF1504FR000
DF1514FR0E0	DF1514FRAB0	DF1514FRA00	DF1514FR000
DF1516FR0E0	DF1516FRAB0	DF1516FRA00	DF1516FR000
DF1521FR0E0	DF1521FRAB0	DF1521FRA00	DF1521FR000

MaxGard® Interconnection Systems

100 Amp Reverse Service

** If receptacle is desired with a Straight Adapter instead of standard Angle Adapter, substitute "S" for the "A" in the catalog number of the Receptacle with Angle Adapter or Adapter and Box.

† Standard cable bushings shown; see **page 34** for other sizes available at no extra cost if specified on order.

†† Always furnished with screw collar. We recommend cup cap with male plug; order catalog number DS1CC.

Maximum lug wire 0 AWG 19-strand or 1 AWG flexible, cable entrance .386" diameter.

Receptacles furnished with flap cap also have screw thread to accept male collar on plug.

Catalog numbers shown are for flap cap receptacles; change "DF" to "DS" for ordering screw cap.

Boldface figures are for voltage assignment. For different ratings, see **page 40**.

Outlet furnished at location "B" unless otherwise specified. 2" NPT.

▼ **Control contacts for plug/receptacles:**
Use "K" where noted. Ex: DS1104MR00K

For Adapters, Junction Boxes and Accessories, see **pages 34-37**.

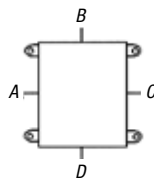

Female Connector

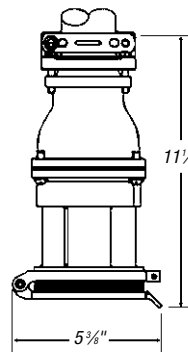

Male Plug††

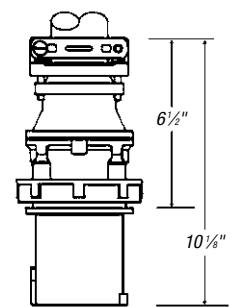

Device Ratings and Polarizations

Maximum 600VAC or 250VDC

(For full polarization, see **page 40**)

POLE	WIRE	CONDUCTOR PLACEMENT	VOLTAGE 60 HZ	CAT. NO.	STANDARD BUSHING I.D. †	CAT. NO.	STANDARD BUSHING I.D. †
2	3		277	DF1104FP000	1 1/16"	DS1104MP000	1 1/16"
			125	DF1107FP000		DS1107MP000	
2	3		480	DF1204FP000	1 1/16"	DS1204MP000	1 1/16"
			250	DF1207FP000		DS1207MP000	
			600	DF1214FP000		DS1214MP000	
			208	DF1216FP000		DS1216MP000	
3	4		277/480	DF1304FP000	1 3/16"	DS1304MP000	1 3/16"
			125/250	DF1307FP000		DS1307MP000	
			120/208	DF1316FP000		DS1316MP000	
3	4		3Ø 480	DF1404FP000	1 3/16"	DS1404MP000	1 3/16"
			3Ø 250	DF1407FP000		DS1407MP000	
			3Ø 600	DF1414FP000		DS1414MP000	
			3Ø 208	DF1416FP000		DS1416MP000	
			3Ø 440	DF1421FP000		DS1421MP000	
4	5		3ØY 277/480	DF1504FP000	2"	DS1504MP000	2"
			3ØY 347/600	DF1514FP000		DS1514MP000	
			3ØY 110/208	DF1516FP000		DS1516MP000	
			3ØY 250/440	DF1521FP000		DS1521MP000	

MaxGard® Interconnection Systems



Male Inlet with Angle Enclosure

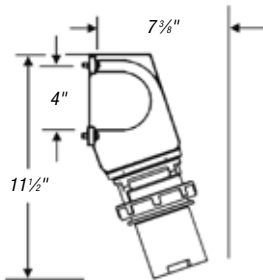

Male Inlet with Angle Adapter** and DJB3 Junction Box

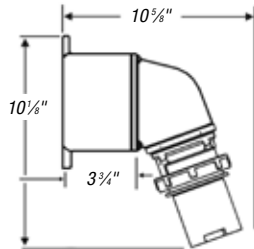

Male Inlet with Angle Adapter**

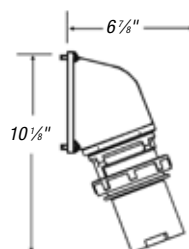

Male Inlet**

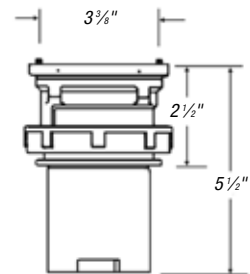

CAT. NO.	CAT. NO.	CAT. NO.	CAT. NO.
DS1104MR0E0	DS1104MRAB0	DS1104MRA00	DS1104MR000
DS1107MR0E0	DS1107MRAB0	DS1107MRA00	DS1107MR000
DS1204MR0E0	DS1204MRAB0	DS1204MRA00	DS1204MR000
DS1207MR0E0	DS1207MRAB0	DS1207MRA00	DS1207MR000
DS1214MR0E0	DS1214MRAB0	DS1214MRA00	DS1214MR000
DS1216MR0E0	DS1216MRAB0	DS1216MRA00	DS1216MR000
DS1304MR0E0	DS1304MRAB0	DS1304MRA00	DS1304MR000
DS1307MR0E0	DS1307MRAB0	DS1307MRA00	DS1307MR000
DS1316MR0E0	DS1316MRAB0	DS1316MRA00	DS1316MR000
DS1404MR0E0	DS1404MRAB0	DS1404MRA00	DS1404MR000
DS1407MR0E0	DS1407MRAB0	DS1407MRA00	DS1407MR000
DS1414MR0E0	DS1414MRAB0	DS1414MRA00	DS1414MR000
DS1416MR0E0	DS1416MRAB0	DS1416MRA00	DS1416MR000
DS1421MR0E0	DS1421MRAB0	DS1421MRA00	DS1421MR000
DS1504MR0E0	DS1504MRAB0	DS1504MRA00	DS1504MR000
DS1514MR0E0	DS1514MRAB0	DS1514MRA00	DS1514MR000
DS1516MR0E0	DS1516MRAB0	DS1516MRA00	DS1516MR000
DS1521MR0E0	DS1521MRAB0	DS1521MRA00	DS1521MR000

MaxGard® Interconnection Systems

200 Amp Standard Service

** If receptacle is desired with a Straight Adapter instead of standard Angle Adapter, substitute "S" for the "A" in the catalog number of the Receptacle with Angle Adapter or Adapter and Box.

† Standard cable bushings shown; see **page 34** for other sizes available at no extra cost if specified on order.

†† Always furnished with screw collar. We recommend cup cap with male plug; order catalog number DS2CC.

Maximum lug wire 4/0 AWG 19-strand or flexible, cable entrance .625" diameter.

Receptacles furnished with flap cap also have screw thread to accept male collar on plug.

Catalog numbers shown are for flap cap receptacles; change "DF" to "DS" for ordering screw cap.

Boldface figures are for voltage assignment. For different ratings, see **page 40**.

Outlet furnished at location "B" unless otherwise specified. 3" NPT.

▼ **Control contacts for plug/receptacles:**
Use "K" where noted. Ex: **DS2104MP00K**

For Adapters, Junction Boxes and Accessories, see **pages 34–37**.

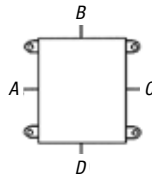

Male Plug††

Female Connector

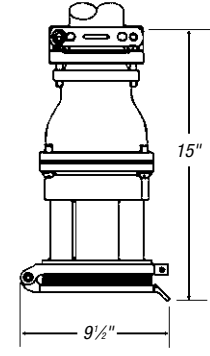
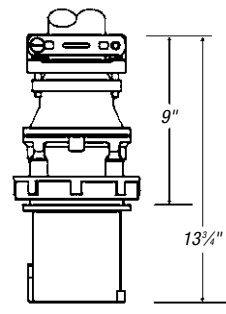

Device Ratings and Polarizations

Maximum 600VAC or 250VDC

(For full polarization, see **page 40**)

POLE	WIRE	CONDUCTOR PLACEMENT	VOLTAGE 60 HZ	CAT. NO.	STANDARD BUSHING I.D.†	CAT. NO.	STANDARD BUSHING I.D.†
2	3		277	DS2104MP000	2 1/8"	DF2104FP000	2 1/8"
			125	DS2107MP000		DF2107FP000	
2	3		480	DS2204MP000	2 1/8"	DF2204FP000	2 1/8"
			250	DS2207MP000		DF2207FP000	
			600	DS2214MP000		DF2214FP000	
			208	DS2216MP000		DF2216FP000	
3	4		277/480	DS2304MP000	2 1/4"	DF2304FP000	2 1/4"
			125/250	DS2307MP000		DF2307FP000	
			120/208	DS2316MP000		DF2316FP000	
3	4		3Ø 480	DS2404MP000	2 1/4"	DF2404FP000	2 1/4"
			3Ø 250	DS2407MP000		DF2407FP000	
			3Ø 600	DS2414MP000		DF2414FP000	
			3Ø 208	DS2416MP000		DF2416FP000	
			3Ø 440	DS2421MP000		DF2421FP000	
4	5		3ØY 277/480	DS2504MP000	2 1/2"	DF2504FP000	2 1/2"
			3ØY 347/600	DS2514MP000		DF2514FP000	
			3ØY 110/208	DS2516MP000		DF2516FP000	
			3ØY 250/440	DS2521MP000		DF2521FP000	

MaxGard® Interconnection Systems



Female Receptacle with Angle Adapter** and Junction Box



Female Receptacle with Angle Adapter**



Female Receptacle

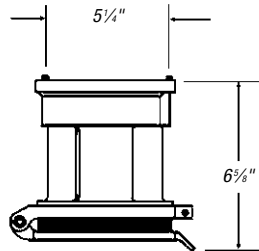
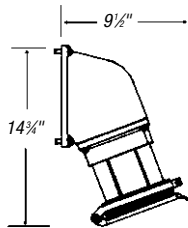
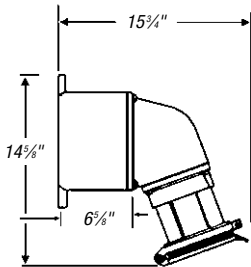

CAT. NO.	CAT. NO.	CAT. NO.
DF2104FRAB0	DF2104FRA00	DF2104FR000
DF2107FRAB0	DF2107FRA00	DF2107FR000
DF2204FRAB0	DF2204FRA00	DF2204FR000
DF2207FRAB0	DF2207FRA00	DF2207FR000
DF2214FRAB0	DF2214FRA00	DF2214FR000
DF2216FRAB0	DF2216FRA00	DF2216FR000
DF2304FRAB0	DF2304FRA00	DF2304FR000
DF2307FRAB0	DF2307FRA00	DF2307FR000
DF2316FRAB0	DF2316FRA00	DF2316FR000
DF2404FRAB0	DF2404FRA00	DF2404FR000
DF2407FRAB0	DF2407FRA00	DF2407FR000
DF2414FRAB0	DF2414FRA00	DF2414FR000
DF2416FRAB0	DF2416FRA00	DF2416FR000
DF2421FRAB0	DF2421FRA00	DF2421FR000
DF2504FRAB0	DF2504FRA00	DF2504FR000
DF2514FRAB0	DF2514FRA00	DF2514FR000
DF2516FRAB0	DF2516FRA00	DF2516FR000
DF2521FRAB0	DF2521FRA00	DF2521FR000

Staten Island Ferry

SOLUTION 200 Amp

200A MaxGard® connections on ferry deck



200A MaxGard® inlets with disconnects



30A and 200A MaxGard® interlocks



200A MaxGard® interlocks in parallel

Russellstoll® Pin and Sleeve Power Connectors

MaxGard® Interconnection Systems

200 Amp Reverse Service

** If receptacle is desired with a Straight Adapter instead of standard Angle Adapter, substitute "S" for the "A" in the catalog number of the Receptacle with Angle Adapter or Adapter and Box.

† Standard cable bushings shown; see **page 34** for other sizes available at no extra cost if specified on order.

†† Always furnished with screw collar. We recommend cup cap with male plug; order catalog number DS2CC.

Maximum lug wire 4/0 AWG 19-strand or flexible, cable entrance .625" diameter.

Receptacles furnished with flap cap also have screw thread to accept male collar on plug.

Catalog numbers shown are for flap cap receptacles; change "DF" to "DS" for ordering screw cap.

Boldface figures are for voltage assignment. For different ratings, see **page 40**.

Outlet furnished at location "B" unless otherwise specified. 3" NPT.



Female Connector

Male Plug††

▼ **Control contacts for plug/receptacles:**
Use "K" where noted. Ex: DS2104MR00K

For Adapters, Junction Boxes and Accessories, see **pages 34–37**.

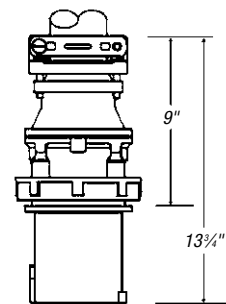
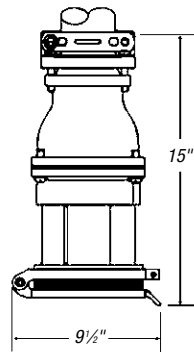
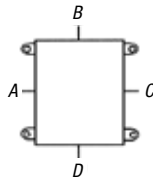

Device Ratings and Polarizations

Maximum 600VAC or 250VDC

(For full polarization, see **page 40**)

POLE	WIRE	CONDUCTOR PLACEMENT	VOLTAGE 60 HZ	CAT. NO.	STANDARD BUSHING I.D. †	CAT. NO.	STANDARD BUSHING I.D. †
2	3		277	DF2104FP000	2 1/8"	DS2104MP000	2 1/8"
			125	DF2107FP000		DS2107MP000	
2	3		480	DF2204FP000	2 1/8"	DS2204MP000	2 1/8"
			250	DF2207FP000		DS2207MP000	
			600	DF2214FP000		DS2214MP000	
			208	DF2216FP000		DS2216MP000	
3	4		277/480	DF2304FP000	2 1/4"	DS2304MP000	2 1/4"
			125/250	DF2307FP000		DS2307MP000	
			120/208	DF2316FP000		DS2316MP000	
3	4		3Ø 480	DF2404FP000	2 1/4"	DS2404MP000	2 1/4"
			3Ø 250	DF2407FP000		DS2407MP000	
			3Ø 600	DF2414FP000		DS2414MP000	
			3Ø 208	DF2416FP000		DS2416MP000	
			3Ø 440	DF2421FP000		DS2421MP000	
4	5		3ØY 277/480	DF2504FP000	2 1/2"	DS2504MP000	2 1/2"
			3ØY 347/600	DF2514FP000		DS2514MP000	
			3ØY 110/208	DF2516FP000		DS2516MP000	
			3ØY 250/440	DF2521FP000		DS2521MP000	

MaxGard® Interconnection Systems



Male Inlet with Angle Enclosure



Male Inlet with Angle Adapter**



Male Inlet††

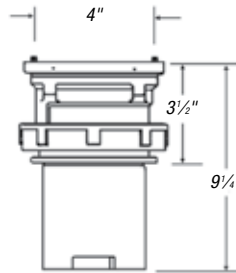
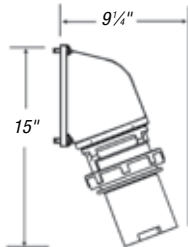
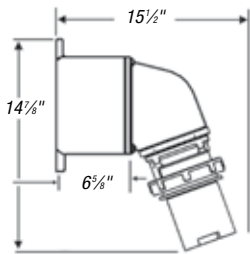

CAT. NO.	CAT. NO.	CAT. NO.
DS2104MRAB0	DS2104MRA00	DS2104MR000
DS2107MRAB0	DS2107MRA00	DS2107MR000
DS2204MRAB0	DS2204MRA00	DS2204MR000
DS2207MRAB0	DS2207MRA00	DS2207MR000
DS2214MRAB0	DS2214MRA00	DS2214MR000
DS2216MRAB0	DS2216MRA00	DS2216MR000
DS2304MRAB0	DS2304MRA00	DS2304MR000
DS2307MRAB0	DS2307MRA00	DS2307MR000
DS2316MRAB0	DS2316MRA00	DS2316MR000
DS2404MRAB0	DS2404MRA00	DS2404MR000
DS2407MRAB0	DS2407MRA00	DS2407MR000
DS2414MRAB0	DS2414MRA00	DS2414MR000
DS2416MRAB0	DS2416MRA00	DS2416MR000
DS2421MRAB0	DS2421MRA00	DS2421MR000
DS2504MRAB0	DS2504MRA00	DS2504MR000
DS2514MRAB0	DS2514MRA00	DS2514MR000
DS2516MRAB0	DS2516MRA00	DS2516MR000
DS2521MRAB0	DS2521MRA00	DS2521MR000

MMI Trailer



SOLUTION 200 Amp

Application:

Electrical hook-up of mobile medical imaging (MMI) trailers

Mobile medical units provide trailer-transportable blood banks, dental clinics, magnetic resonance imaging (MRI), X-ray and other diagnostic equipment to many hospitals and clinics throughout the country on a regular leased basis. Safe outdoor usage connections are required for up to 200-amp power supplies at each facility. Major specialized custom trailer manufacturers rely on the MaxGard® 200-amp interface.

Installation:

Site-mounted 200-amp receptacles with trailer-mounted plugs and connectors

When a mobile medical unit trailer is at the desired location, a heavy-duty MaxGard® 200-amp cable assembly connects the trailer with a corresponding receptacle or connector at each site, usually mounted on an outside wall. A primary safety feature is the receptacle's gated deadfront construction that ensures no exterior access to live receptacle contacts. With so many different hands involved on a daily basis, the MaxGard epoxy powder-coat finish and rugged waterproof construction provide hospital-safe long service life.

Russellstoll® Pin and Sleeve Power Connectors

MaxGard® Interconnection Systems

400 Amp Standard Service

** If receptacle is desired with a Straight Adapter instead of standard Angle Adapter, substitute "S" for the "A" in the catalog number of the Receptacle with Angle Adapter or Adapter and Box.

† Standard cable bushings shown; see **page 34** for other sizes available at no extra cost if specified on order.

†† Always furnished with screw collar. We recommend cup cap with male plug; order catalog number DS4CC.

Maximum lug wire 500 kcmil 37-strand or flexible, cable entrance .937" diameter.

Receptacles furnished with flap cap also have screw thread to accept male collar on plug.

Catalog numbers shown are for flap cap receptacles; change "DF" to "DS" for ordering screw cap.

Boldface figures are for voltage assignment. For different ratings, see **page 40**.

Outlet furnished at location "B" unless otherwise specified. 4" NPT.

▼ **Control contacts for plug/receptacles:**
Use "K" where noted. Ex: **DS4104MP00K**

For Adapters, Junction Boxes and Accessories, see **pages 34-37**.

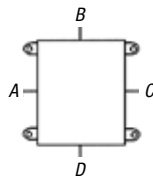

Male Plug††

Female Connector

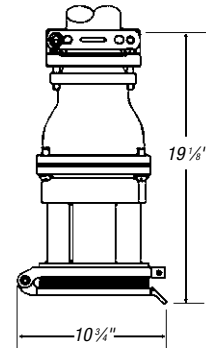
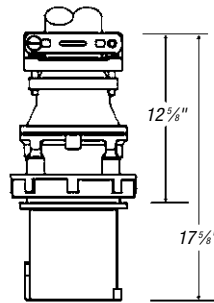

Device Ratings and Polarizations

Maximum 600VAC or 250VDC

(For full polarization, see **page 40**)

POLE	WIRE	CONDUCTOR PLACEMENT	VOLTAGE 60 HZ	CAT. NO.	STANDARD BUSHING I.D. †	CAT. NO.	STANDARD BUSHING I.D. †
2	3		277	DS4104MP000	2 1/4"	DF4104FP000	2 1/4"
			125	DS4107MP000		DF4107FP000	
2	3		480	DS4204MP000	2 1/4"	DF4204FP000	2 1/4"
			250	DS4207MP000		DF4207FP000	
			600	DS4214MP000		DF4214FP000	
			208	DS4216MP000		DF4216FP000	
3	4		277/480	DS4304MP000	3"	DF4304FP000	3"
			125/250	DS4307MP000		DF4307FP000	
			120/208	DS4316MP000		DF4316FP000	
3	4		3Ø 480	DS4404MP000	3"	DF4404FP000	3"
			3Ø 250	DS4407MP000		DF4407FP000	
			3Ø 600	DS4414MP000		DF4414FP000	
			3Ø 208	DS4416MP000		DF4416FP000	
			3Ø 440	DS4421MP000		DF4421FP000	
4	5		3ØY 277/480	DS4504MP000	3 1/4"	DF4504FP000	3 1/4"
			3ØY 347/600	DS4514MP000		DF4514FP000	
			3ØY 110/208	DS4516MP000		DF4516FP000	
			3ØY 250/440	DS4521MP000		DF4521FP000	

MaxGard® Interconnection Systems



Female Receptacle with Angle Adapter** and Junction Box



Female Receptacle with Angle Adapter**



Female Receptacle

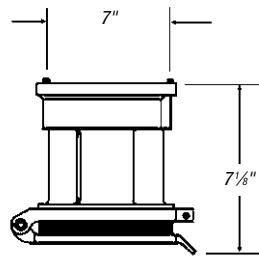
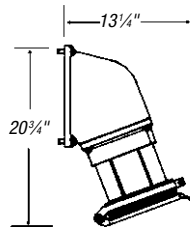
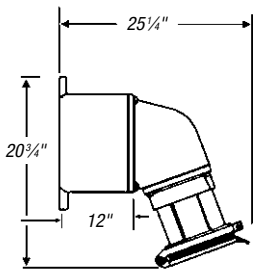

CAT. NO.	CAT. NO.	CAT. NO.
DF4104FRAB0	DF4104FRA00	DF4104FR000
DF4107FRAB0	DF4107FRA00	DF4107FR000
DF4204FRAB0	DF4204FRA00	DF4204FR000
DF4207FRAB0	DF4207FRA00	DF4207FR000
DF4214FRAB0	DF4214FRA00	DF4214FR000
DF4216FRAB0	DF4216FRA00	DF4216FR000
DF4304FRAB0	DF4304FRA00	DF4304FR000
DF4307FRAB0	DF4307FRA00	DF4307FR000
DF4316FRAB0	DF4316FRA00	DF4316FR000
DF4404FRAB0	DF4404FRA00	DF4404FR000
DF4407FRAB0	DF4407FRA00	DF4407FR000
DF4414FRAB0	DF4414FRA00	DF4414FR000
DF4416FRAB0	DF4416FRA00	DF4416FR000
DF4421FRAB0	DF4421FRA00	DF4421FR000
DF4504FRAB0	DF4504FRA00	DF4504FR000
DF4514FRAB0	DF4514FRA00	DF4514FR000
DF4516FRAB0	DF4516FRA00	DF4516FR000
DF4521FRAB0	DF4521FRA00	DF4521FR000

Shore-to-ship power

SOLUTION

200 Amp

Application:

Shore power to marine vessels — sightseeing boats

When docked, marine vessels need shore power when their engines aren't running. Dockside designs need to be as safe as possible during heavy use, rough treatment and adverse weather conditions. High amperage-rated systems are installed using parallel power delivery with cross-network protection.

Installation:

400-amp male inlets and power connectors with control contacts

Watertight devices are necessary for dockside installations. MaxGard® connections go further with O-rings on both pins and interiors for environmental separation and true waterproof performance. The male inlet center ground pin feature and keyed entry design align easily, make ground first and break last, while quarter-turn insertion delayed-action removal and locking screw collars provide accidental pull-out protection. Upon connector insertion, two auxiliary control contacts complete a contactor circuit, which powers the line through a make-last-and-break-first configuration. Contactors are installed separately in an on-shore sheltered power distribution panel.

This can be wired for each contactor or for multiple connections; if one plug is removed, power is cut off.

Russellstoll® Pin and Sleeve Power Connectors

MaxGard® Interconnection Systems

400 Amp Reverse Service

** If receptacle is desired with a Straight Adapter instead of standard Angle Adapter, substitute "S" for the "A" in the catalog number of the Receptacle with Angle Adapter or Adapter and Box.

† Standard cable bushings shown; see **page 34** for other sizes available at no extra cost if specified on order.

†† Always furnished with screw collar. We recommend cup cap with male plug; order catalog number DS4CC.

Maximum lug wire 500 kcmil 37-strand or flexible, cable entrance .937" diameter.

Receptacles furnished with flap cap also have screw thread to accept male collar on plug.

Catalog numbers shown are for flap cap receptacles; change "DF" to "DS" for ordering screw cap.

Boldface figures are for voltage assignment.

For different ratings, see **page 40**.

Outlet furnished at location "B" unless otherwise specified. 4" NPT.

▼ **Control contacts for plug/receptacles:**
Use "K" where noted. Ex: DS4104MR00K

For Adapters, Junction Boxes and Accessories, see **pages 34-37**.

Device Ratings and Polarizations

Maximum 600VAC or 250VDC

(For full polarization, see **page 40**)

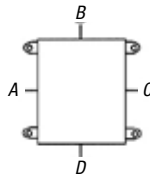

Female Connector

Male Plug††

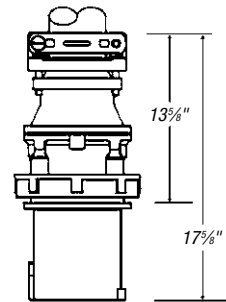
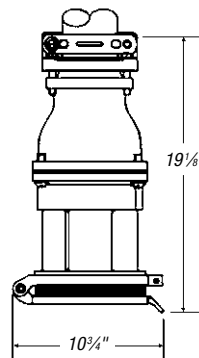

POLE	WIRE	CONDUCTOR PLACEMENT	VOLTAGE 60 HZ	CAT. NO.	STANDARD BUSHING I.D.†	CAT. NO.	STANDARD BUSHING I.D.†		
2	3		277	DF4104FP000	2 3/4"	DS4104MP000	2 3/4"		
			125	DF4107FP000		DS4107MP000			
2	3		480	DF4204FP000		3"		DS4204MP000	3"
			250	DF4207FP000				DS4207MP000	
			600	DF4214FP000				DS4214MP000	
			208	DF4216FP000				DS4216MP000	
3	4		277/480	DF4304FP000	3"	DS4304MP000	3"		
			125/250	DF4307FP000		DS4307MP000			
			120/208	DF4316FP000		DS4316MP000			
3	4		3Ø 480	DF4404FP000	3 1/4"	DS4404MP000	3 1/4"		
			3Ø 250	DF4407FP000		DS4407MP000			
			3Ø 600	DF4414FP000		DS4414MP000			
			3Ø 208	DF4416FP000		DS4416MP000			
			3Ø 440	DF4421FP000		DS4421MP000			
4	5		3ØY 277/480	DF4504FP000	3 1/4"	DS4504MP000	3 1/4"		
			3ØY 347/600	DF4514FP000		DS4514MP000			
			3ØY 120/208	DF4516FP000		DS4516MP000			
			3ØY 250/440	DF4521FP000		DS4521MP000			

MaxGard® Interconnection Systems



Male Inlet with Angle Adapter** and Junction Box

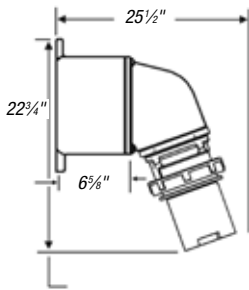

Male Inlet with Angle Adapter**

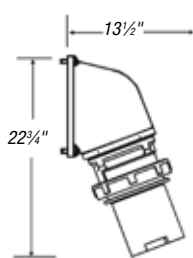

Male Inlet††

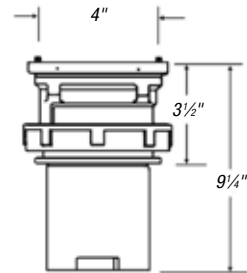

Russellstoll® Pin and Sleeve Power Connectors

CAT. NO.	CAT. NO.	CAT. NO.
DS4104MRAB0	DS4104MRA00	DS4104MR000
DS4107MRAB0	DS4107MRA00	DS4107MR000
DS4204MRAB0	DS4204MRA00	DS4204MR000
DS4207MRAB0	DS4207MRA00	DS4207MR000
DS4214MRAB0	DS4214MRA00	DS4214MR000
DS4216MRAB0	DS4216MRA00	DS4216MR000
DS4304MRAB0	DS4304MRA00	DS4304MR000
DS4307MRAB0	DS4307MRA00	DS4307MR000
DS4316MRAB0	DS4316MRA00	DS4316MR000
DS4404MRAB0	DS4404MRA00	DS4404MR000
DS4407MRAB0	DS4407MRA00	DS4407MR000
DS4414MRAB0	DS4414MRA00	DS4414MR000
DS4416MRAB0	DS4416MRA00	DS4416MR000
DS4421MRAB0	DS4421MRA00	DS4421MR000
DS4504MRAB0	DS4504MRA00	DS4504MR000
DS4514MRAB0	DS4514MRA00	DS4514MR000
DS4516MRAB0	DS4516MRA00	DS4516MR000
DS4521MRAB0	DS4521MRA00	DS4521MR000

MaxGard® Interconnection Systems

Cable Bushings for MaxGard® Plugs and Connectors

To order non-standard bushing, add cable bushing number to the end of a catalog number. The bushing is furnished at no additional cost at time of order.

Ex: DF2504FP000/DF2032.

Shaded areas show Cable Bushings provided with a strain-relief neck; larger bushings are collar style.



Size No. 3 and 6
(Identification Letter Inside Hole)



Size No. 10, 20 and 40

HOLE DIAMETER FOR CABLE	SIZE 3 30 AMP	SIZE 6 60 AMP	SIZE 10 100 AMP	SIZE 20 200 AMP	SIZE 40 400 AMP
.625"	JG63				
.750"	JG64	JG104			
.875"	JG65	JG105			
1.000"	JG66	JG106	DF1020	DF2020	
1.188"	JG67	JG107	DF1022	DF2022	
1.313"		JG108	DF1024	DF2024	
1.375"	JG69				
1.500"	JG610	JG1010	DF1026	DF2026	
1.625"					
1.688"		JG1011	DF1027	DF2027	
1.813"			DF1029	DF2029	
1.875"		JG1013	DF1030	DF2032	
2.000"			DF1032		
2.125"				DF2034	
2.250"				DF2036	
2.500"				DF2040	
2.625"					DF4042
2.750"					DF4044
3.000"					DF4048
3.250"					DF4054

Standard Cable Bushings

Notes: When ordering, select bushing size slightly larger than your cable O.D. for best fit.

Material — Neoprene

MaxGard® Interconnection Systems

Adapters for Conduit and Fittings

Adapters are tapped NPT standard pipe thread to accommodate rigid conduit or standard connectors for armored and non-metallic cable or flexible conduit.



JPA Conduit Adapters

30 AMP CAT. NO.	TAPPED HOLE SIZE NPT	60 AMP CAT. NO.	TAPPED HOLE SIZE NPT	100 AMP CAT. NO.	TAPPED HOLE SIZE NPT	200 AMP CAT. NO.	TAPPED HOLE SIZE NPT	400 AMP CAT. NO.	TAPPED HOLE SIZE NPT
JPA62	¾"	JPA104	1¼"	DFA14	1¼"	DFA25	1½"	DFA46	2"
JPA63	1"	JPA105	1½"	DFA15	1½"	DFA26	2"	DFA47	2½"
JPA64	1¼"	JPA 106	2"	DFA16	2"	DFA27	2½"	DFA48	3"
JPA65	1½"	—	—	—	—	—	—	—	—

Note:

Material — cast aluminum, corrosion-resistant copper-free alloy, electrostatic epoxy coated. Furnished complete with gasket and screws.

To specify standard plugs or connectors equipped with one of the above adapters, add the catalog number of the adapter selected to the catalog number of the plug or connector. Complete list price is the list price of the device plus list price of the adapter.

Ex.: Cat. No. DS3107MP000 with adapter tapped 1" would be Cat. No. DS3107MP000/JPA63.

Replacement Flap Covers and Screw Covers

- For connectors, receptacles and interlocks

CAT. NO.	DESCRIPTION	AMPERAGE
DFC3	Flap Cover Assembly (Weathertight)	30
DFC6		60
DFC10		100
DFC20		200
DFC40		400
DSC3	Screw Cap and STS — Lanyard Assembly (Watertight)	30
DSC6		60
DSC10		100
DSC20		200
DSC40		400









DFC6



DSC6

MaxGard® Interconnection Systems

Accessories for Receptacles

	DESCRIPTION	30 AMP CAT. NO.	60 AMP CAT. NO.	100 AMP CAT. NO.	200 AMP CAT. NO.	400 AMP CAT. NO.
	<p>Cup Caps For watertight plugs/inlets. Cup caps are used where portable equipment is on a standby basis and plugs are not in use. Effectively protect insulation and contacts from excessive moisture, dirt, dust and corrosion.</p> <p>Material — Cast aluminum, corrosion-resistant copper-free alloy, electrostatic epoxy coated with steel braid cable attached.</p>	DS3CC	DS6CC	DS1CC	DS2CC	DS4CC
	<p>Adapter Flush Frames — Single Gang Provide suitable means for mounting box covers of junction box receptacles flush in a wall.</p>	JFA3	JFA6	JFA10	JFA20	—
	<p>Adapters for Conduit Box Receptacles Adapters to fit existing boxes and for special mounting requirements can also be furnished. Consult your Thomas & Betts representative.</p> <p>20° Vertical Angle Adapter</p> <p>30° Vertical Angle Adapter</p> <p>45° Vertical Angle Adapter</p> <p>Straight Adapter</p>	JAA6-AB6 — JAA6-45 JRA6-AB6	JAA10 — JAA10-45 JRA10	DAA10 — — DRA10	DAA20 — — DRA20	— DAA40 — DRA40
	<p>Junction Box — Single Gang</p>	JB6-1	JB10-B150	JB10-B200	DJB20	DJB40
	<p>Angle Enclosure</p>	JE6	JE10	JE10M	—	—
	<p>MACK Adapter Plates Enables mounting of MaxGard® receptacles to competitive existing back boxes. This involves removing the existing non-hazardous location receptacle from back box, inserting adapter plate and installing MaxGard® receptacle. Adapter plates are available for competitors' boxes including Hubbel, Killark, Appleton and Crouse-Hinds.</p>	DCCA3	DCCA6	DCCA10	DCCA20	—
	<p>Russellstoll® Adapter Plates Adapt MaxGard® receptacles to existing J-Line™, Angle Type and Heavy-Service Ever-Lok® back boxes.</p>	DRCA3	DRCA6	DRCA10	—	N/A

MaxGard® Interconnection Systems

Replacement Interiors for Receptacles, Connectors, Plugs and Male Inlets



Russellstoll® Pin and Sleeve Power Connectors

RATING	VOLTAGE POLARIZATION	CORRESPONDING MALE INTERIOR ASSEMBLY		CORRESPONDING FEMALE INTERIOR ASSEMBLY		
		PLUG/INLET	MALE INTERIOR	CONNECTOR/RECEPTACLE*	FEMALE INTERIOR	
30A	2P3W	125VAC	DS3107MP000	DFPU3107	DF3107FP000	DFRU3107
	2P3W	250VAC	DS3207MP000	DFPU3207	DF3207FP000	DFRU3207
	3P4W	125/250VAC	DS3307MP000	DFPU3307	DF3307FP000	DFRU3307
	3P4W	3-ph 480VAC	DS3404MP000	DFPU3404	DF3404FP000	DFRU3404
	4P5W	277/480VAC	DS3504MP000	DFPU3504	DF3504FP000	DFRU3504
60A	2P3W	250VAC	DS6207MP000	DFPU6207	DF6207FP000	DFRU6207
	3P4W	125/250VAC	DS6307MP000	DFPU6307	DF6307FP000	DFRU6307
	3P4W	3-ph 480VAC	DS6404MP000	DFPU6404	DF6404FP000	DFRU6404
	4P5W	277/480VAC	DS6504MP000	DFPU6504	DF6504FP000	DFRU6504
100A	2P3W	250VAC	DS1207MP000	DFPU1207	DF1207FP000	DFRU1207
	3P4W	125/250VAC	DS1307MP000	DFPU1307	DF1307FP000	DFRU1307
	3P4W	3-ph 480VAC	DS1404MP000	DFPU1404	DF1404FP000	DFRU1404
	4P5W	277/480VAC	DS1504MP000	DFPU1504	DF1504FP000	DFRU1504
200A	3P4W	277/480VAC	DS2304MP000	DFPU2304	DF2304FP000	DFRU2304
	3P4W	3-ph 480VAC	DS2404MP000	DFPU2404	DF2404FP000	DFRU2404
	4P5W	277/480VAC	DS2504MP000	DFPU2504	DF2504FP000	DFRU2504
400A	3P4W	277/480VAC	DS4304MP000	DFPU4304	DF4304FP000	DFRU4304
	3P4W	3-ph 480VAC	DS4404MP000	DFPU4404	DF4404FP000	DFRU4404
	4P5W	277/480VAC	DS4504MP000	DFPU4504	DF4504FP000	DFRU4504

Note: For other interiors not shown, use same polarization index as plug, connector, etc. Ex: DS6416MP000 plug uses a DFPU6416 interior. If your original product had option "K - Control Contacts," include a "K" at the end of the replacement part number. Ex: If your plug/inlet is a DS3404MP00K, then the male replacement interior would be a DFPU3404K. If your connector/receptacle is a DF3404FP00K, then your female replacement/interior would be a DFRU3404K.

* To order replacement interior parts for the MaxGard Interlock, replace "DFRU" with "DFIU".

Accessories for Interlocked NEMA 12/3R Receptacles

DESCRIPTION	30 AMP CAT. NO.	60 AMP CAT. NO.	100 AMP CAT. NO.	200 AMP CAT. NO.	400 AMP CAT. NO.
Fused Disconnect Interlocked Receptacle with Safety Switch 30-100A					
1 NO — 1 NC Contact	F34757	F34757	F34757	N/A	N/A
2 NO — 2 NC Contact	F34758	F34756B	N/A	N/A	N/A
Copper Body Lugs — 6 lugs per kit	F34756A	F34756B	F34756C	N/A	N/A
Type R Fuse Clips — 3 per kit	F34755A	F34755B	F34755C	N/A	N/A
Neutral Block	F34754A	F34754B	F34754B	N/A	N/A

MaxGard® Interconnection Systems

Pin and Sleeve Plugs, Receptacles and Systems

1.0 Scope

- 1.1 This document covers multi-contact pin and sleeve, industrial grade, arc-quenching, circuit interrupting-rated electrical plugs, motor plugs, connectors, receptacles, mechanically interlocked receptacles and assorted accessories. Usable in dry, damp, wet, marine and/or hazardous locations for electrical power circuits. Devices are to be rated 30, 60, 100, 200 and/or 400 amperes at 600VAC, 50–400 Hz and 250VDC maximum. Devices are also rated for continuous use in temperatures from -40° C to +130° C. These devices must provide internal environmental seals for marine and extreme wet applications and can be electrically interlocked.
- 1.2 The devices described shall be Thomas & Betts/Russellstoll® MaxGard® catalog numbers as specified.

2.0 Product Classifications (Features)

- 2.1 **Gated Deadfront** — All receptacles and connectors must have a rotating disk on the face of the interior, which provides live contact isolation and environmental separation.
- 2.2 **Delayed Action Arc Containment** — All devices upon disconnect under load shall have provision so the arc is contained and extinguished within the insulation cavity, making it impossible to withdraw a live plug.
- 2.3 **Flap Cover or Screw Cover Option** — Flap cover option must provide weathertight capability by utilizing a spring actuated self-closing flap. Watertight capability shall be obtained by using a gasketed screw cap.
- 2.4 **Polarization** — All devices shall be factory polarized for amperage, voltage, frequency and phase; thus providing a single voltage rating, single interface system.
- 2.5 **Grounding** — The grounding of the device shall be accomplished through a separate center ground (earth) make-first and break-last pole on all devices for complete system grounding.

- 2.6 **Pole Capabilities** — All devices shall accommodate up to four power pins plus a separate center ground pin and they shall be integral with the connector bodies (five pins total).
- 2.7 **Interior Type** — Interiors must be male (pin type) or female (sleeve type). Pins and sleeves shall also be self-aligning and self-wiping/self-cleaning.
- 2.8 **Control Contacts** — All devices must have an option for two control contacts, which shall be make-last and break-first for use in electrical interlocks and/or control circuits. See table **below**.
- 2.9 **Conductor Terminals** — Pin and sleeve connections shall employ solderless pressure-type screw terminals and be sized to accept stranded or solid copper conductors in AWG sizes (max. O.D.s as noted). The screw terminals shall also have socket heads to ensure proper torquing of wires.
- 2.10 **Environmental Seals** — Each device must have an environmental seal or O-ring around all interiors and around each pin and sleeve to prevent water and contaminants from entering the wiring compartment. This provides waterproof capability, even when not mated.
- 2.11 **Hazardous Location** — All standard plugs 30, 60 and 100 amp shall be UL® and CSA listed for hazardous location Class I Division 1, Groups C and D; Class II Division 1, Groups F and G. A hazardous location circuit breaker-protected interlock shall also be applicable to the same environments and possess all the same product features as outlined above. Enclosures shall meet NEMA 8 hazardous outdoor-duty classifications and shall meet shipboard use above deck in accordance with the Department of Transportation (USCG "Green Water").
- 2.12 **Lockout Devices** — Plug connection lockout is achieved by a padlock through plug sleeve housing hole provided for this purpose. On Hazardous Location/Explosion Proof Interlock Receptacles, lockout shall additionally be achieved by separate lockout accessory available from the factory. On standard Interlocks, lockout accessory/construction is available from the factory.

Rating for Pilot/Control Contacts

Contact Rating Code Designation A-600, Table 119.1 — UL 508 Heavy Pilot Duty Load (720 VA/600VAC) Maximum

THERMAL CONTINUOUS CURRENT AMPS	MAXIMUM CURRENT AMPERE									
	120V		240V		480V		600V		MAX. VOLT AMPERE	
	Make	Break	Make	Break	Make	Break	Make	Break	Make	Break
10 (#12 AWG)	60	6	30	3	15	1.5	12	1.2	7200	720

MaxGard® Interconnection Systems

3.0 Materials Requirements

- 3.1 **Housings** — Plug, motor plug, receptacles, connectors and interlock housings, associated covers and caps, screw collars, and clamp holders shall be made of copper-free cast aluminum (max. .004% copper).
- 3.2 **Finish** — All external surfaces except those that provide means of grounding shall be epoxy powder coated to resist corrosion.
- 3.3 **Hardware** — All hardware, external and springs, shall be stainless steel. Cable clamps shall be stainless steel or epoxy powder coated, copper-free cast aluminum.
- 3.4 **Insulators** — All device body insulators shall be molded from glass-reinforced high-strength thermoset polyester, minimum of UL® 94-V0 flammability rated.
- 3.5 **Contacts** — Contacts base material shall be made of a conductive copper alloy (brass CDA485) to prevent dezincification. Accessory material of the contacts shall be made of a compatible corrosion resistant material.
- 3.6 **Environmental Seals** — Environmental gaskets and O-rings shall be made of Neoprene material.

4.0 Design and Construction Requirements

- 4.1 **Circuit Interrupting Rating** — All devices 30, 60, 100 and 200 amperes shall be tested to be interrupted at 150% of rated current. Additionally, all devices shall be designed and tested to interrupt 100% of rated current.
- 4.2 **Wiring** — All devices shall be wired from the rear requiring no disassembly of the pins and/or sleeves from the insulated body.
- 5.0 **Applicable Documents (Compliances)**
 - 5.1 **Underwriters Laboratories (UL)** — The devices specified herein shall be listed in applicable sections of UL Standards 1010, 231, 1682 and 1686, File Nos. E2630, E57324, E68085, E123752.
 - 5.2 **Canadian Standard Association (CSA)** — The devices specified shall be listed in the applicable sections of CSA C22.2-182.1, File Number LR14096.
 - 5.3 **International Electro-Technical Commission (IEC)** — The 30-, 60- and 100-ampere devices specified shall have been tested and comply with IEC 309-1.
 - 5.4 **Federal Department of Transportation** — Refrigerated National Shipboard location devices shall meet and comply with Federal Register volume 47, number 68, subpart 111.79.
 - 5.5 **Standards** — The devices specified shall comply with Military Standards MIL-STD-105 and 1344; ASTM Standards D570 and D2565; NEMA Standard PR4-1983; and OSHA regulations when installed in accordance with the National Electrical Code® (NEC®).

5.6 NEMA 250 Enclosures Standard

- NEMA 1** — General Purpose for indoor use; guards against contact with equipment.
- NEMA 3R** — Outdoor use primarily to protect against rain, sleet, wind-blown dust and damage from external ice formation.
- NEMA 4** — Indoor or outdoor use to protect against windblown dust and rain; splashing and hose-directed water.
- NEMA 4X** — Watertight, dust-tight corrosion-resistant for indoor or outdoor applications.
- NEMA 6** — Watertight, casual/temporary immersion.
- NEMA 7** — Class I (Hazardous) for indoor use in Class I areas, per NEC®.
- NEMA 8** — Class I (Hazardous) for indoor use in Class I, oil-immersed equipment.
- NEMA 9** — Class II (Hazardous) for indoor use in Class II areas, per NEC®.
- NEMA 12** — Industrial use, dust-tight for indoor use to protect against dust, falling dirt and dripping non-corrosive liquids.

NEC and National Electrical Code are registered trademarks of the National Fire Protection Association, Inc.

MaxGard® Interconnection Systems

Single Polarization/Multiple Service* Assigned Voltages and Wiring Systems

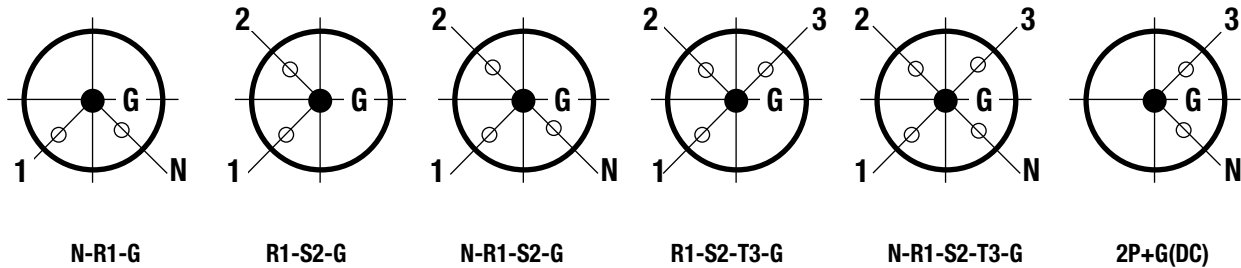

VOLTAGE ASSIGN. NO.	VOLTAGE	VOLTAGE ASSIGN. NO.	VOLTAGE	VOLTAGE ASSIGN. NO.	VOLTAGE	VOLTAGE ASSIGN. NO.	VOLTAGE	VOLTAGE ASSIGN. NO.	VOLTAGE	VOLTAGE ASSIGN. NO.	VOLTAGE	INDEX
101	220V-50 Hz	201	380V-50 Hz	301	220/380V-50 Hz	401	380V-50 Hz	501	220/380V-50 Hz			01
103	127V-50 Hz	203	220V-50 Hz	303	220/127V-50 Hz	403	220V-50 Hz	503	220/127V-50 Hz			03
104	277V-60 Hz	204	480V-60 Hz	304	277/480V-60 Hz	404	3Ø 480V-60 Hz	504	3ØY 277/480V-60 Hz			04
105	250V-50 Hz	205	440V-50 Hz	305	250/440V-50 Hz	405	3Ø 440V-50 Hz	505	3Ø 250/440V-50 Hz			05
107	125V-60 Hz	207	250V-60 Hz	307	125/250V-60 Hz	407	3Ø 250V-60 Hz	507	3ØY 125/250V-60 Hz			07
108	220V-60 Hz	208	380V-60 Hz	308	220/380V-60 Hz	408	3Ø 380V-60 Hz	508	3Ø 220/380V-60 Hz			08
109	100V-60 Hz	209	220V-60 Hz	309	100/220V-60 Hz	409	3Ø 220V-60 Hz	509	3Ø 100/220V-60 Hz			09
111	115V-400 Hz	211	220V-400 Hz	311	220/115V-400 Hz	411	220V-400 Hz	511	220/115V-400 Hz			11
—	—	—	—	—	—	—	—	513	230V DC	613	250 VDC	13
114	347V-60 Hz	214	600V-60 Hz	314	347/600V-60 Hz	414	3Ø 600V-60 Hz	514	3ØY 347/600V-60 Hz			14
115	100V-50 Hz	215	220V-50 Hz	315	100/220V-50 Hz	415	3Ø 220V-50 Hz	515	3Ø 100/220V-50 Hz			15
116	120V-60 Hz	216	208V-60 Hz	316	120/208V-60 Hz	416	3Ø 208V-60 Hz	516	3ØY 120/208V-60 Hz			16
117	120V-400 Hz	217	208V-400 Hz	317	120/208V-400 Hz	417	3Ø 208V-400 Hz	517	3Ø 120/208V-400 Hz			17
—	—	—	—	—	—	—	208V	—	—	618	28 VDC	18
—	—	221	440V-60 Hz	321	250/440V-60 Hz	421	3Ø 440V-60 Hz	521	3ØY 250/440V-60 Hz			21
—	—	—	—	—	—	—	250V	Reserved	—	—	—	22
—	—	—	—	—	—	—	480V	Reserved	—	—	—	23
—	—	—	—	—	—	—	600V	Reserved	—	—	—	24

MaxGard® receptacles and plugs may be furnished in any of the above voltage and phasing systems.

To order any device in a voltage and phasing not shown in the preceding catalog pages, substitute the Voltage Assignment Number in the **above** chart for that portion of the listed catalog number appearing in **boldface** type.

Example: 200 Amp Weathertight Receptacle with Flap Cover, Angle Adapter and Junction Box for 3Ø 480 volt (3-pole and ground) is DF2404FRAB0.

To change to 3Ø 208 volt, the catalog number becomes DF2416FRAB0.

Note: All devices may be furnished with two control contacts. Add "K" to the end of the catalog number, in place of last position Ø.

*** Dual-Voltage or Multiple-Service Applications** (for any given polarization number) — Example: A factory installation may consist of all receptacles specified and wired at polarization "507." This is a 3ph. Y-125/250V-60 Hz supply. However, all circuit requirements "below" (507) can also be met; for instance a "207" plug will draw phasing for 250V-60 Hz operation of equipment as well, while another ".507" receptacle supplies power for a 3-phase motor installation. See chart **above**.

For non-interrupting polarizations at 45, 90, 150, 300, 600A ratings, consult Technical Services.

MaxGard® Interconnection Systems

Male Plug

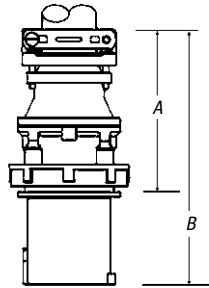

AMP	A	B
30	4 ³ / ₄ "	7 ⁷ / ₈ "
60	5 ¹ / ₂ "	9 ¹ / ₈ "
100	6 ¹ / ₂ "	10 ¹ / ₈ "
200	9"	13 ³ / ₄ "
400	12 ⁵ / ₈ "	17 ⁵ / ₈ "

Connector

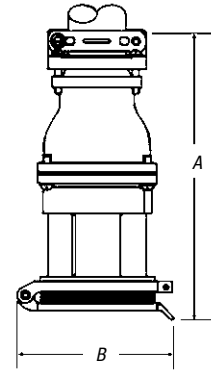

AMP	A	B
30	8 ³ / ₄ "	5 ¹ / ₈ "
60	10"	5 ³ / ₈ "
100	11 ¹ / ₈ "	5 ³ / ₈ "
200	15"	9 ¹ / ₂ "
400	19 ⁵ / ₈ "	10 ³ / ₄ "

Russellstoll® Pin and Sleeve Power Connectors

Male Inlet

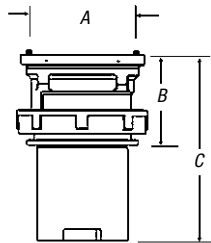

AMP	A	B	C
30	2 ¹ / ₈ "	2 ¹ / ₂ "	5 ¹ / ₂ "
60	3 ³ / ₈ "	2 ¹ / ₂ "	5 ¹ / ₂ "
100	3 ³ / ₈ "	2 ¹ / ₂ "	5 ¹ / ₂ "
200	5 ¹ / ₄ "	3 ¹ / ₂ "	9 ¹ / ₄ "
400	3 ³ / ₈ "	4 ³ / ₈ "	9 ¹ / ₄ "

Receptacle with Angle Enclosure

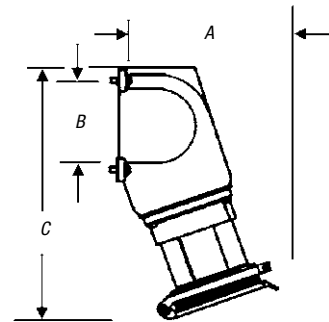

AMP	A	B	C
30	6 ⁵ / ₈ "	3 ¹ / ₈ "	9 ¹ / ₈ "
60	7 ¹ / ₈ "	4"	11 ¹ / ₈ "
100	7 ¹ / ₂ "	4"	11 ¹ / ₈ "
200	—	—	—
400	—	—	—

(Flap covers shown — screw covers available. On all, screw covers have nominal effect on outside dimensions.)

MaxGard® Interconnection Systems

Receptacle with Angle Adapter and DJB Junction Box

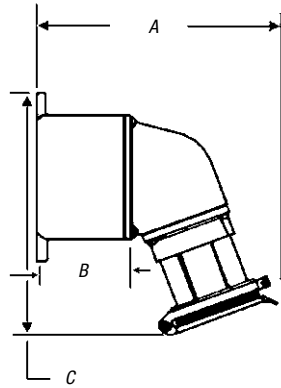

AMP	A	B	C
30	9 ¹ / ₈ "	3"	9 ⁵ / ₈ "
60	10 ¹ / ₂ "	3"	9 ³ / ₄ "
100	10 ³ / ₄ "	3 ³ / ₄ "	10"
200	15 ³ / ₄ "	6 ⁵ / ₈ "	14 ⁵ / ₈ "
400	25 ¹ / ₄ "	12"	20 ³ / ₄ "

Receptacle with Angle Adapter

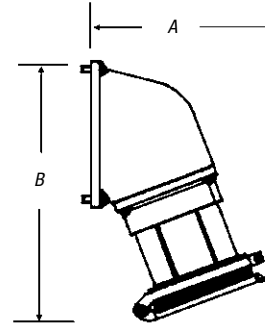

AMP	A	B
30	6 ¹ / ₈ "	9 ⁵ / ₈ "
60	7 ¹ / ₂ "	9 ³ / ₄ "
100	7"	10"
200	9 ¹ / ₂ "	14 ⁵ / ₈ "
400	13 ¹ / ₄ "	20 ³ / ₄ "

(Flap covers shown — screw covers available. On all, screw covers have nominal effect on outside dimensions.)

Receptacle Only

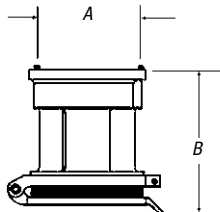

AMP	A	B
30	2 ⁷ / ₈ "	4 ¹ / ₂ "
60	3 ³ / ₈ "	5 ¹ / ₈ "
100	3 ⁵ / ₈ "	5 ³ / ₈ "
200	5 ¹ / ₄ "	6 ⁵ / ₈ "
400	7"	7 ¹ / ₈ "

MaxGard® Interconnection Systems

Industrial interlocked receptacles are available in 30 through 400 Amp. Switched receptacles have mechanical linkages for added safety. Safety features include:

- Plugs cannot be inserted unless power is safely turned off
- Plugs cannot be removed until power is safely turned off
- Specialty designs may also automatically disengage power if plug is removed while power is on, either mechanically or electrically

Applications

Applications where these units are most commonly used are:

- Welding stations in automotive and heavy industry
- Temporary and portable power distribution for construction
- Marine shore-to-ship power
- Industrial machinery installation
- Portable power distribution, vehicle and gen-set power for aerospace
- Custom systems in all industries



Russellstoll® Pin and Sleeve Power Distribution Systems

Sample Installation: Fixed Power Source (Wall) to Remote/Portable Location

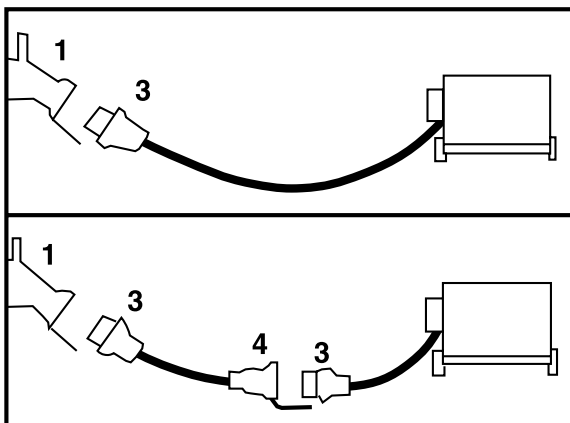

1. Receptacle (wall-mounted female)
2. Receptacle (panel-mounted female)
3. Plug (attachment)

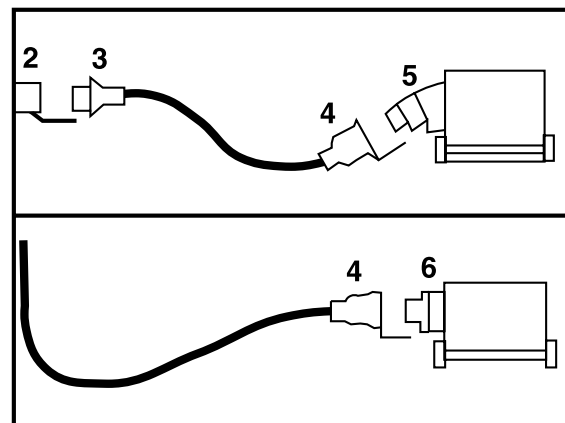

4. Female connector
5. Male Inlet with angle adapter
6. Male inlet with straight adapter

Other installations: generator power sources, custom control circuits, multiple voltage service — contact Technical Services.

MaxGard® Interconnection Systems

MaxGard® Fused-Disconnect** Interlocked Receptacle with Disconnect Switch

MaxGard® Fused-Disconnect Interlocked Receptacle with Safety Switch meets UL®, NEC® and major automotive specifications. This unit is the maximum in:

Safety

- Door safety switch with three external lockout points
- Safety fuse pulls for standard class R fuses
- Backup door safety latch

Durability

- Heavy .060 steel galvaneel with baked enamel, NEMA 3R/12 construction
- Clear shield for test probes

Performance

- Standard 600V cartridge fuse clips and spacing
- Fully interlocked MaxGard® receptacle
- Angled front receptacle for easier access



Ordering Information

Maximum 600VAC or 250VDC

Notes: **Non-fused, non UL version available:

Specify DNRF _____.

Standard polarizations shown. Boldface figures are for voltage assignment; for different ratings, see page 40.

User Made Possible Conduit Hubs

AMP	STD. NPT THREAD OUTLET	MAX.
30	1½"	2½"
60	2"	2½"
100	2"	2½"

Specifications on pages 38-39.

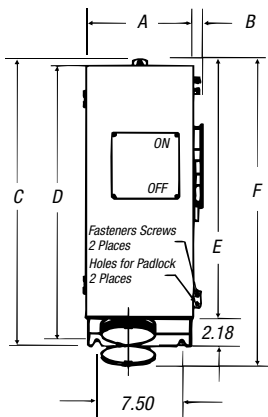

	POLES/ WIRES	VOLTAGE	FUSED DISCONNECT** INTERLOCKED RECEPTACLE		STD. BUSHING ID
			NEMA 12/3R CAT. NO.	MATING MAXGARD PLUG CAT. NO.	
30 AMP	2P3W	125	DFRF31070	DS3107MP000	¾"
	2P3W	250	DFRF32070	DS3207MP000	¾"
	3P4W	3Ø250	DFRF33070	DS3307MP000	1"
	3P4W	3Ø480	DFRF34040	DS3404MP000	1"
	4P5W	277/480	DFRF35040	DS3504MP000	1¼"
60 AMP	2P3W	250	DFRF62070	DS6207MP000	1¼"
	3P4W	125/250	DFRF63070	DS6307MP000	1¼"
	3P4W	3Ø480	DFRF64040	DS6404MP000	1¼"
	4P5W	277/480	DFRF65040	DS6504MP000	1½"
100 AMP	2P3W	250	DFRF12070	DS1207MP000	1½"
	3P4W	125/250	DFRF13070	DS1307MP000	1½"
	3P4W	3Ø480	DFRF14040	DS1404MP000	1½"
	4P5W	277/480	DFRF15040	DS1504MP000	2"

▼ Control Contacts (position 9) use "K" example: DFRF1207K. Always use liquidtight fittings to limit condensation entry.

Dimensions

AMP	A	B	C	D	E	F
30	9½"	¾"	25¾"	25"	22¾"	30"
60	9½"	¾"	25¾"	25"	22¾"	30"
100	9½"	¾"	25¾"	25"	22¾"	30"



MaxGard® Interconnection Systems

Maximum 600VAC/250VDC

MaxGard® NEMA 4X interlocks are ideal for demanding non-hazardous areas where dust, dirt, moisture and corrosion might be a problem — such as shipyards, food processing facilities, manufacturing operations or similar areas.

Safety

- Gated deadfront waterproof receptacle
- Standard, high AIC or NA/switch circuit breaker
- Protective screw cap for watertight protection

Durability

- Thick-wall cast copper-free aluminum housing with epoxy powder-coat finish
- Heavy-duty sliding bar interlock mechanism

Performance

- Heavy on/off handle adds mechanical ability to electrical interlock function
- Standard conduit openings through top or side

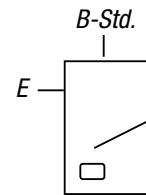
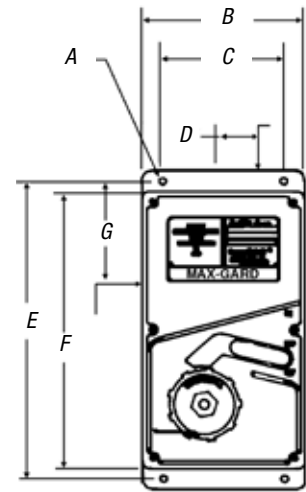

Russellstoll® Pin and Sleeve Power Connectors



Boldface figures are for voltage assignment; for different ratings, see page 40.

	POLES/ WIRES	VOLTAGE	MECHANICALLY INTERLOCKED RECEPTACLE NEMA 4X CAT. NO.	MATING MAXGARD PLUG CAT. NO.	STD. BUSHING ID
30 Amp	2P3W	125	DBRS310703000	DS3107MP000	7/8"
	2P3W	250	DBRS320703000	DS3207MP000	7/8"
	3P4W	30/250	DBRS330703000	DS3307MP000	1"
	3P4W	30/480	DBRS340403000	DS3404MP000	1"
60 Amp	4P5W	277/480	DBRS350403000	DS3504MP000	1 1/16"
	2P3W	250	DBRS620706000	DS6207MP000	1 3/16"
	3P4W	125/250	DBRS630706000	DS6307MP000	1 5/16"
	3P4W	30/480	DBRS640406000	DS6404MP000	1 5/16"
100 Amp	4P5W	277/480	DBRS650406000	DS6504MP000	1 1/2"
	2P3W	250	DBRS120710000	DS1207MP000	1 11/16"
	3P4W	125/250	DBRS130710000	DS1307MP000	1 13/16"
	3P4W	30/480	DBRS140410000	DS1404MP000	1 3/8"
200 Amp	4P5W	277/480	DBRS150410000	DS1504MP000	2"
	3P4W	277/480	DBRS230720000	DS2307MP000	1 1/4"
	3P4W	30/480	DBRS240420000	DS2404MP000	2 1/4"
	4P5W	277/480	DBRS250420000	DS2504MP000	2 1/2"
400 Amp	3P4W	277/480	DBRS430740000	DS4307MP000	3"
	3P4W	30/480	DBRS440440000	DS4404MP000	3"
	4P5W	277/480	DBRS450440000	DS4504MP000	3 1/4"

(Flap-Cap available by replacing "DBRS" with "DBRF")

Conduit Hubs: (at B or E)

AMP	STD. NPT THREAD OUTLET	MAX.
30	1 1/2"	2 1/2"
60	1 1/2"	2 1/2"
100	2"	2 1/2"
200	2"	3"
400	4"	4"

▼ **Control Contacts** (position 12) use "K" example: DBRS6104060K0

Shunt Trip Breaker (position 13) add "Z" to above: DBRS6104060KZ

Breaker Trip Ratings (positions 9, 10, 11) 30 amp use 030; 60 amp use 060; alternate trip ratings available — consult Technical Services

Non-Auto Sw. NAO (repl. "DBRF" with "DSRF")

For additional full line and polarization options, see page 40.

Dimensions

AMP	A	B	C	D	E	F	G
30	3/8"	8 3/4"	6 1/2"	1 1/2"	16 1/4"	15 1/8"	3 1/8"
60	3/8"	8 3/4"	6 1/2"	1 1/2"	16 1/4"	15 1/8"	3 1/8"
100	3/8"	8 3/4"	6 1/2"	1 1/2"	16 1/4"	15 1/8"	3 1/8"
200	3/8"	12 1/4"	9"	2 1/2"	26 1/4"	24 3/4"	5"
400	3/8"	15 1/2"	12"	3"	30 1/2"	29"	6"

MaxGard® Interconnection Systems

Explosion-Proof Applications

Russellstoll® Hazardous-Duty Plugs, Receptacles and Interlocks are designed to support a variety of installation needs throughout 20A, 30A, 60A and 100A ranges where Division 1, Class 1 NEC® guidelines require the utmost in safety.

Unique among others, the Russellstoll® MaxGard® also offers true O-ring sealed waterproof design protection in addition to standard threaded flame-path construction employed elsewhere. In rough service, washdown and outdoor applications, MaxGard® performance goes beyond normal explosion-proof ratings.

With coming increases in harmonized designations for classifications between NFPA/NEC® and IEC (International) hazardous area standards, a quick reference classification chart is provided below. In all cases, the customer must determine and approve proper area classification standards and degree of harmonized standards acceptance.



HAZARDOUS MATERIALS ENVIRONMENT	U.S. NEC STANDARDS	EURO IEC STANDARDS
Gas or Vapor	Div. 1, Class I Div. 2, Class I	Zone 0 and 1 Zone 2
Dust	Div. 1, Class II Div. 2, Class II	Zone 10 Zone 11
Fibers/Flyings	Div. 1, Class III Div. 2, Class III	Zone 10 Zone 11
GROUP APPLICATIONS	NEC ART. 500 CLASS I: GROUPS	NEC ART. 505 ZONES 0, 1 AND 2
Div. 1 and 2, Class I	A: Acetylene	IIC
	B: Hydrogen	IIB
	C: Ethylene	IIB
	D: Propane	IIA

The above chart is presented for quick reference only and should only be used in conjunction with noted Articles. Further definition of harmonized standards will be supported by Russellstoll through appropriate specification efforts whenever practical.

MaxGard® Interconnection Systems

MaxGard® DBRE and DSRE Series Interlocks are the only devices certified both explosion-proof and waterproof, along with optional control contacts, and are fully UL® Listed.

Explosion-Proof Waterproof Circuit Breaker Interlocked Receptacle

Available in 30-, 60- and 100-amp sizes, all polarizations. Division 1, Class I and II.



UL and CSA listed for hazardous locations

Class I, Division 1, Groups B, C and D
 Class II, Division 1, Groups F and G
 UL File E10919
 NEMA 7, 8, 9
 CSA
 DOT shipboard used above deck "green water"
 NEMA 4X
 USCG approved



Explosion-Proof Non-Interlocked Receptacle

Available in 30A 480VAC max., all polarizations

- Factory-sealed interior (no filled conduits)
- Easy low-cost installation



UL and CSA listed for hazardous locations

Class I, Division 1, C and D
 Class II, Division 1, Groups F and G
 UL File E10919
 NEMA 7, 8, 9
 CSA
 DOT shipboard used above deck "green water"
 NEMA 4X
 USCG approved



MaxGard® Interconnection Systems

Maximum
600VAC or 250VDC



Explosion-Proof Interlocked
Receptacle with Circuit Breaker
Class I, Class II



Explosion-Proof
Receptacle, Class I, Class II



Male Plug

	POLES/ WIRES	VOLTAGE (VAC)	CAT. NO.	CAT. NO.	CAT. NO.	STD. BUSHING I.D.*
30 Amp						
	2P3W	125	DBRE310703000	DSE3107FRO	DS3107MP000	7/8"
	2P3W	250	DBRE320703000	DSE3207FRO	DS3207MP000	7/8"
	3P4W	30250	DBRE330703000	DSE3307FRO	DS3307MP000	1"
	3P4W	30480	DBRE340403000	DSE3404FRO	DS3404MP000	1"
	4P5W	277/480	DBRE350403000	DSE3504FRO	DS3504MP000	1 1/8"
60 Amp						
	2P3W	250	DBRE620706000	—	DS6207MP000	1 1/8"
	3P4W	30250	DBRE630706000	—	DS6307MP000	1 1/8"
	3P4W	30480	DBRE640406000	—	DS6404MP000	1 1/8"
	4P5W	277/480	DBRE650406000	—	DS6504MP000	1 1/2"
100 Amp						
	2P3W	250	DBRE120710000	—	DS1207MP000	1 11/16"
	3P4W	30250	DBRE130710000	—	DS1307MP000	1 13/16"
	3P4W	30480	DBRE140410000	—	DS1404MP000	1 13/16"
	4P5W	277/480	DBRE150410000	—	DS1504MP000	2"

Boldface figures are for voltage assignment; for different ratings, see **page 40**.

* For additional bushing sizes, accessories and specification information, see **pages 34–39**.

Note: For additional full line and polarization options, see **page 40**.

▼ **Control Contacts** (position 12) use "K" example: DBRE6404060K0

Shunt Trip Breaker (position 13) add "Z" to above: DBRE6404060KZ

Breaker Trip Ratings (positions 9, 10, 11) 30 amp use O30; 60 amp use O60; alternate trip ratings are available — consult Technical Services

Non-Auto Sw. NAO (repl. "DBRE" with "DSRE")

MaxGard® Interconnection Systems

Dimensions

Explosion-Proof Receptacle

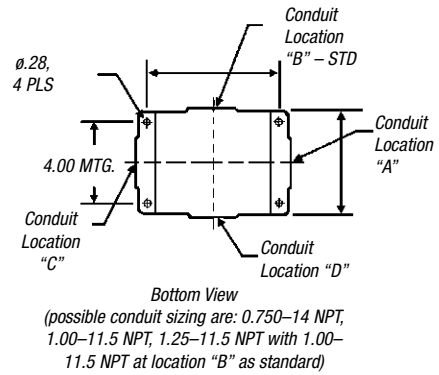
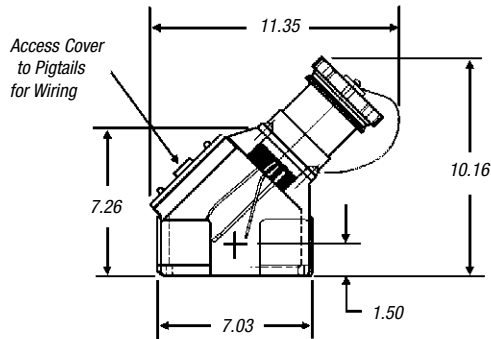

Explosion-Proof Interlocked Receptacle

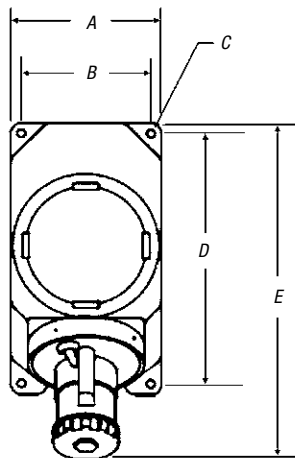

Conduit Sizing

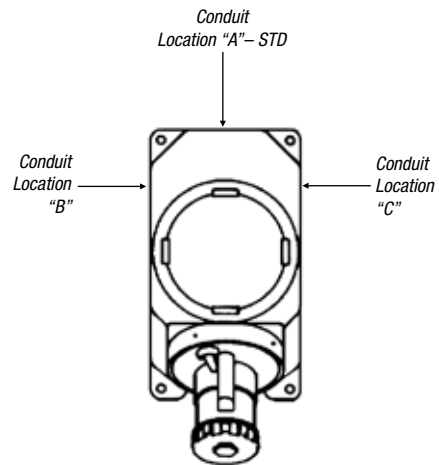

AMP	A	B	C	D	E
30	8¾"	7½"	½"	14¾"	20"
60	8¾"	7½"	½"	14¾"	20"
100	8¾"	7½"	½"	14¾"	20"

AMP	STANDARD
30	1.25"
60	1.50"
100	2.00"

Note: Range is 0.750–14 NPT through 2.00–11.5 NPT.

GSUL Safe Ground Indicator System

Prevents operation of pumps without a safe ground for static dissipation.

Class I, Division 1, Groups C, D, and Zone 1, Groups IIB, IIA; NEMA 7 Class II, Division 1, Groups E, F, G; NEMA 9

Instant Visual Confirmation of Safe Ground

The Russellstoll® GSUL Safe Ground Indicator System is designed to ensure that a safe ground has been established for dissipating ever-present static electricity from tank vehicles, carriers, drums and other conductive equipment before allowing the transfer of flammable materials. The GSUL indicates the establishment of a safe ground via two parallel-connected green signal lights. Two lights are used for redundancy — if one lamp burns out, visual indication of safe grounding will be maintained by the other.

Intrinsically Safe Circuitry

The GSUL Safe Ground Indicator System features an intrinsically safe, low-energy ground-sensing circuit, which does not carry sufficient electrical energy to cause ignition in classified Hazardous Locations.

In operation, the ground-sensing circuit extends through the grounding clamp and its connection to the ground indicator, the metal portion of the vehicle between the jaw terminals of the clamp and earth ground electrode.

Pumps Won't Operate Until Safe Ground Is Established

A control relay in the GSUL Safe Ground Indicator System provides interlocked control of pump motors at the loading platform. The electronic control circuit will be de-energized while the green lights are off. Attaching the clamps to the tank closes the interlocking contact and energizes the control circuits to the motors.

Applications

Volatile or classified areas such as:

- Tank farms
- Petrochem
- Cosmetics
- Grain mills
- Vehicular or rail transport

..... Specifications

Enclosure: Cast copper-free aluminum with epoxy powder-coated finish

Outlets: Regularly furnished tapped ¾" NPT

Relay Contacts: Rated ½ HP, 10A, 120VAC; ½ HP, 10A, 240VAC

Certifications: UL® Listed, CSA Certified

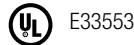

Unit shown with covers removed

GSUL Safe Ground Indicator System

GSUL Safe Operating Features

- Two redundant, parallel green indicator lights glow when safe ground is established
- Lamps offer approximately 20,000 hours of operating life
- Unit may be ordered without lights where remote visual indication is desired
- Intrinsically safe, simplified circuitry
- Integral, intrinsically safe wiring compartment with approved strain-relief fitting for connection of cable from grounding clamp
- Solid-state actuating and control circuits mounted on removable printed circuit board
- Enclosure protects components against moisture
- Control relay provided for interlocked control of pump motor at loading rack
- Grounding clamp (ordered separately) provides dual isolated tip contacts in a heavy-duty cast-aluminum handle design

Wiring Diagram

Ground Electrode Connection
(1 electrode required not provided by Russellstoll)

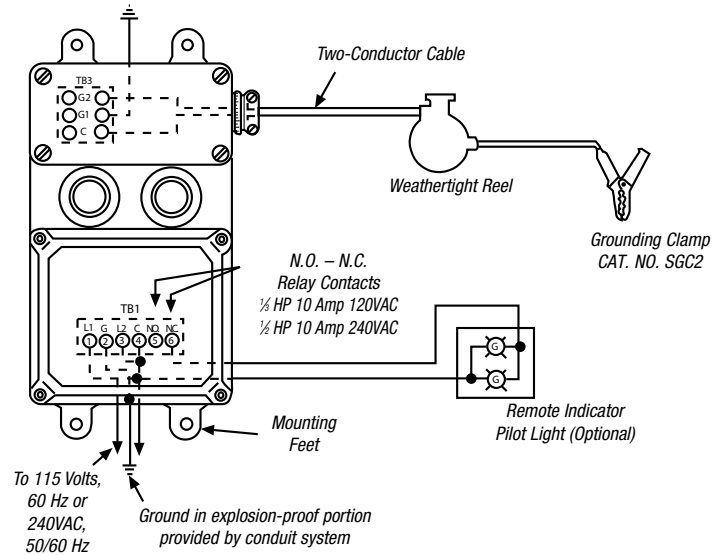

Russellstoll® Pin and Sleeve Power Connectors

Typical Installation



GCC1

Aerospace/Industrial Static Ground Devices

Static grounding receptacles are used in airport and aerospace installations worldwide during fueling, testing and maintenance procedures. Normal mounting is concrete/tarmac floor inset, threaded onto copper ground rod.

Heavy brass construction cup includes optional cover and receptacle's contact pin. Accommodates a wide variety of single-contact (copper on steel wire) static ground wire clamps in service.

CAT. NO.	DESCRIPTION
GCC1	Ground cup with cover*
GC1	Ground cup without cover*
F06146	Replacement contact tip**

* Hub is tapped for 3/4"-10.

** Hub is tapped for 1/2"-13.

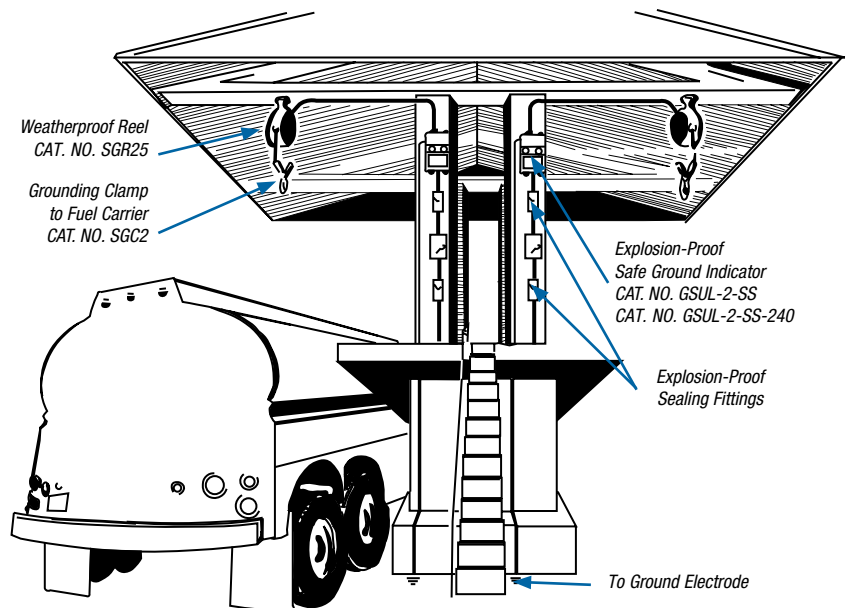

Loading rack illustration suggests a typical installation, which includes an Explosion-Proof Switch, Explosion-Proof Sealing Fittings, Weathertight Reel and the GSUL-2-SS Safe Ground indicator with 2-wire grounding clamp.

GSUL Safe Ground Indicator System

Russellstoll® Pin and Sleeve Power Connectors



GSUL-2-SS

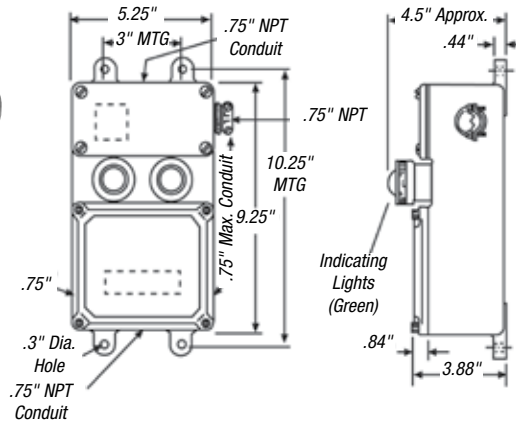

SGC2



SGR25
SGR50
SGR75

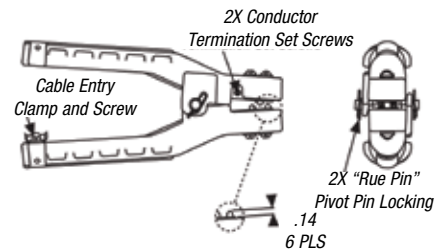
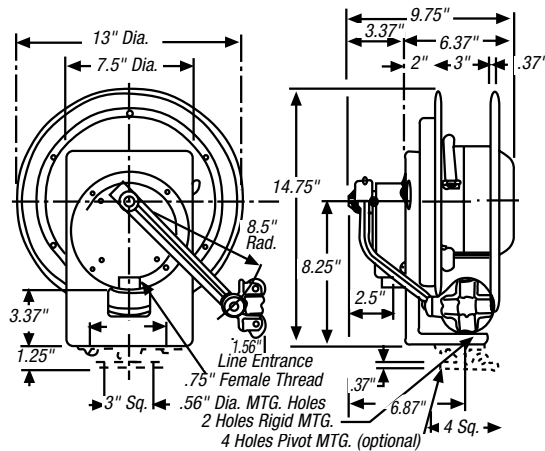

CAT. NO.	DESCRIPTION
GSUL2SS	Safe Ground Indicator with Indicator Lights, 120V, UL®/CSA
GSUL2SS-240	Safe Ground Indicator with Indicator Lights, 240V, CSA
SGC2	Safe Ground Static Clamp
SGR25	Weathertight Retracting Reel with 25 ft. of 12/2 SJO-W Cable
SGR50	Weathertight Retracting Reel with 50 ft. of 12/2 SJO-W Cable
SGR75	Weathertight Retracting Reel with 75 ft. of 12/2 SJO-W Cable
Replacement Parts for GSUL	
C13662	Printed Circuit Board, 120 Volts (includes relay)
GX24RCB	Printed Circuit Board, 240 Volts (includes relay)
F30674	Control Relay
F30602	Lamp Socket Assembly
ELAG	Pilot Light Globe Assembly (green)
310993	Lamp for GSUL2SS
Replacement Parts for SGC2	
GX2TK	Ground Clamp Repair Kit