

GENERAL INFORMATION

MINI DROPIN™

Internally Threaded Expansion Anchor

PRODUCT DESCRIPTION

The Mini Dropin is a carbon steel machine bolt anchor for use in shallow embedment applications. In addition to solid concrete and precast hollow core plank, it can be used in post-tensioned concrete slabs and concrete pours over steel deck.

GENERAL APPLICATIONS AND USES

- Suspending Conduit
- Fire Sprinkler
- Cable Trays and Strut
- Utilities
- Pipe Supports
- Suspended Lighting

FEATURES AND BENEFITS

- + Internally threaded anchor for easy bolt removability and service work
- + Ideal for precast hollow core plank and post-tensioned concrete slabs
- + Lip provides flush installation and consistent embedment
- + Manual setting tool scores flange when set to verify proper expansion depth

APPROVALS AND LISTINGS

- Tested in accordance with ASTM E 488 and AC01 criteria
- Factory Mutual Research Corporation (FM Approvals) – File No. J.I. 3002071
See listing for applicable sizes - www.fmglobal.com

GUIDE SPECIFICATIONS

CSI Divisions: 03 16 00 - Concrete Anchors and 05 05 19 - Post-Installed Concrete Anchors. Anchors shall be Mini Dropin anchors as supplied by Powers Fasteners, Inc., Brewster, NY.

SECTION CONTENTS

General Information..... 1
 Material and Installation Specifications 1
 Performance Data..... 2
 Design Criteria (Allowable Stress Design) 3
 Ordering Information..... 4



MINI DROPIN

THREAD VERSION

- UNC Thread

ANCHOR MATERIALS

- Zinc Plated Carbon Steel

ROD/ANCHOR SIZE RANGE (TYP.)

- 1/4" diameter to 1/2" diameter

SUITABLE BASE MATERIALS

- Normal-weight Concrete
- Lightweight Concrete
- Precast Hollow Core Plank
- Concrete Over Steel Deck

MATERIAL AND INSTALLATION SPECIFICATIONS

Material Specification

Anchor Component	Carbon Steel
Anchor Body	SAE 1009
Plug	SAE 1009
Zinc Plating	ASTM B633, SC1, Type III (Fe/Zn 5)

Installation Specification

Dimension	Rod/Anchor Diameter, d		
	1/4"	3/8"	1/2"
ANSI Drill Bit Size d_{bit} (in.)	3/8	1/2	5/8
Maximum Tightening Torque, T_{max} , (ft-lbs)	3	5	10
Thread Size (UNC)	1/4-20	3/8-16	1/2-13
Thread Depth (in.)	3/8	13/32	5/8
Overall Anchor Length (in.)	5/8	3/4	1

INSTALLATION PROCEDURES

Drill a hole into the base material to the depth of embedment required. The tolerances of the drill bit used must meet the requirements of ANSI Standard B212.15.

In post-tensioned concrete slabs, take care to avoid drilling into the post-tensioned cables.

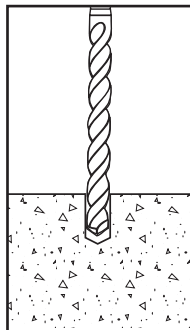

Blow the hole clean of dust and other materials. Insert the anchor into the hole and tap flush with surface. Using a Powers setting tool specifically, set the anchor by driving the tool with a sufficient number of hammer blows until the shoulder of the tool is seated against the anchor. Anchor will not hold allowable loads required if shoulder of Powers setting tool does not seat against anchor.

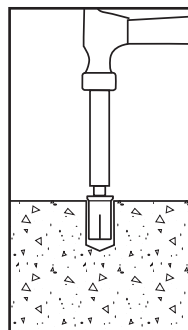

If using a fixture, position it, insert bolt and tighten. Most overhead applications utilize threaded rod. Minimum thread engagement should be at least one anchor diameter.

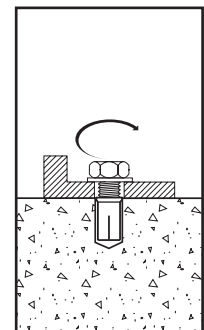

PERFORMANCE DATA

Ultimate Load Capacities for Mini Dropin in Normal-Weight Concrete^{1,2}

Rod/Anchor Size d in. (mm)	Minimum Embedment Depth h _v in. (mm)	Minimum Concrete Compressive Strength (f _c)					
		3,000 psi (20.7 MPa)		4,000 psi (27.6 MPa)		6,000 psi (41.4 MPa)	
		Tension lbs. (kN)	Shear lbs. (kN)	Tension lbs. (kN)	Shear lbs. (kN)	Tension lbs. (kN)	Shear lbs. (kN)
1/4 (6.4)	5/8 (15.9)	1,100 (6.3)	1,260 (5.7)	1,150 (5.1)	1,650 (7.4)	1,200 (5.3)	1,650 (7.4)
3/8 (9.5)	3/4 (19.1)	1,980 (8.9)	2,700 (12.2)	2,120 (9.5)	4,220 (19.0)	2,270 (10.2)	4,220 (19.0)
1/2 (12.7)	1 (25.4)	3,360 (15.1)	4,400 (19.8)	3,360 (15.1)	4,875 (21.9)	3,750 (16.9)	4,875 (21.9)

1. Tabulated load values are for anchors installed in concrete. Concrete compressive strength must be at the specified minimum at the time of installation.
2. Ultimate load capacities must be reduced by a minimum safety factor of 4.0 or greater to determine allowable working load.



Allowable Load Capacities for Mini Dropin in Normal-Weight Concrete^{1,2}

Rod/Anchor Size d in. (mm)	Minimum Embedment Depth h _v in. (mm)	Minimum Concrete Compressive Strength (f _c)					
		3,000 psi (20.7 MPa)		4,000 psi (27.6 MPa)		6,000 psi (41.4 MPa)	
		Tension lbs. (kN)	Shear lbs. (kN)	Tension lbs. (kN)	Shear lbs. (kN)	Tension lbs. (kN)	Shear lbs. (kN)
1/4 (6.4)	5/8 (15.9)	275 (1.2)	315 (1.4)	285 (1.3)	415 (1.9)	300 (1.3)	415 (1.9)
3/8 (9.5)	3/4 (19.1)	495 (2.2)	675 (3.0)	530 (2.4)	1,055 (4.7)	570 (2.6)	1,055 (4.7)
1/2 (12.7)	1 (25.4)	840 (3.8)	1,100 (5.0)	840 (3.8)	1,220 (5.5)	940 (4.2)	1,220 (5.5)

1. Allowable load capacities listed are calculated using and applied safety factor of 4.0.
2. Linear interpolation may be used to determine allowable loads for intermediate compressive strengths.



Ultimate and Allowable Load Capacities for Mini Dropin Installed Through Steel Deck into Lightweight Concrete^{1,2,3}

Rod/Anchor Size d in. (mm)	Minimum Embedment Depth h _v in. (mm)	Lightweight Concrete Over Min. 20 Ga. Steel Deck. f _c ≥ 3,000 psi (20.7 MPa)			
		Minimum 1-3/4" Wide Deck			
		Ultimate Load		Allowable Load	
		Tension lbs. (kN)	Shear lbs. (kN)	Tension lbs. (kN)	Shear lbs. (kN)
1/4 (6.4)	5/8 (15.9)	740 (3.3)	1,880 (8.5)	185 (0.8)	470 (2.1)
3/8 (9.5)	3/4 (19.1)	880 (4.0)	2,040 (9.2)	220 (1.0)	510 (2.3)
1/2 (12.7)	1 (25.4)	1,380 (6.2)	2,120 (9.5)	345 (1.6)	530 (2.4)

1. The metal deck shall be No. 22 gage to No. 18 gage thick steel [0.030-inch to 0.047-inch base metal thickness (0.75 mm to 1.20 mm)].
2. Allowable load capacities listed are calculated using and applied safety factor of 4.0.
3. Tabulated load values are for anchors installed with a minimum edge distance of 7/8" when installed through the lower flute. Anchors installed through the upper flute may be in any location provided the proper installation procedures are maintained.

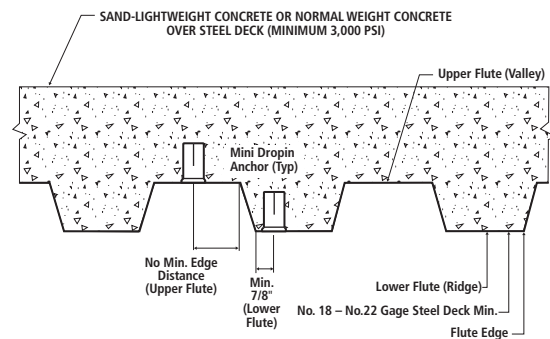

MECHANICAL ANCHORS

MINI DROPIN™
Internally Threaded Expansion Anchor



Ultimate and Allowable Load Capacities for Mini Dropin in Precast Hollow Core Concrete Plank^{1,2}

Rod/ Anchor Size d in. (mm)	Minimum Embed. Depth h, in. (mm)	Minimum Spacing in. (mm)	Minimum Edge Distance in. (mm)	Min. Concrete Compressive Strength f'c ≥ 5,000 psi (34.5 MPa)			
				Ultimate Load		Allowable Load	
				Tension lbs. (kN)	Shear lbs. (kN)	Tension lbs. (kN)	Shear lbs. (kN)
1/4 (6.4)	5/8 (15.9)	3 (76.2)	3 (76.2)	1,400 (6.2)	1,840 (8.3)	350 (1.6)	460 (2.1)
3/8 (9.5)	3/4 (19.1)	4-1/2 (114)	4-1/2 (114)	2,600 (11.7)	3,400 (15.3)	650 (2.9)	850 (3.8)
1/2 (12.7)	1 (25.4)	6 (152.4)	6 (152.4)	2,600 (11.7)	3,540 (15.9)	650 (2.9)	885 (4.0)

1. Tabulated load values are for anchors installed in concrete. Concrete compressive strength must be at the specified minimum at the time of installation.
2. Allowable load capacities listed are calculated using and applied safety factor of 4.0.

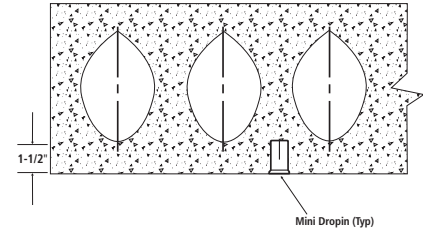

DESIGN CRITERIA (ALLOWABLE STRESS DESIGN)

Combined Loading

For anchors loaded in both shear and tension, the combination of loads should be proportioned as follows:

$$\left(\frac{N_u}{N_n}\right) + \left(\frac{V_u}{V_n}\right) \leq 1$$

Where: N_u = Applied Service Tension Load
 N_n = Allowable Tension Load
 V_u = Applied Service Shear Load
 V_n = Allowable Shear Load

LOAD ADJUSTMENT FACTORS FOR SPACING AND EDGE DISTANCE^{1,2,3}

Anchor Installed in Normal-weight Concrete

Anchor Dimension	Load Type	Critical Distance (Full Anchor Capacity)	Critical Load Factor	Minimum Distance (Reduced Capacity)	Minimum Load Factor
Spacing (s)	Tension and Shear	$s_{cr} = 3.0h_v$	$F_{NC} = F_{VC} = 1.0$	$s_{min} = 1.5h_v$	$F_{NS} = F_{VS} = 0.50$
Edge Distance (c)	Tension	$c_{cr} = 12d$	$F_{NC} = F_{VC} = 1.0$	$c_{min} = 6d$	$F_{NC} = 0.90$
	Shear ¹	$c_{cr} = 12d$	$F_{NC} = F_{VC} = 1.0$	$c_{min} = 6d$	$F_{VC} = 0.75$

1. Allowable loads for anchors loaded in shear parallel to the edge have no load factor $F_{VC} = 1.0$ when installed at minimum edge distances.
2. Allowable load values found in the performance data tables are multiplied by reduction factors when anchor spacing or edge distances are less than critical distances. Linear interpolation is allowed for intermediate anchor spacing and edge distances between critical and minimum distances. When an anchor is affected by both reduced spacing and edge distance, the spacing and edge reduction factors must be combined (multiplied). Multiple reduction factors for anchor spacing and edge distance may be required depending on the anchor group configuration.

Anchor Installed in Through Steel Deck Structural Lightweight Concrete

Anchor Dimension	Load Type	Critical Distance (Full Anchor Capacity)	Critical Load Factor	Minimum Distance (Reduced Capacity)	Minimum Load Factor
Spacing (s)	Tension and Shear	$s_{cr} = 3.0h_v$	$F_{NS} = F_{VS} = 1.0$	$s_{min} = 1.5h_v$	$F_{NS} = F_{VS} = 0.50$

3. Allowable load values found in the performance data tables are multiplied by reduction factors when anchor spacing is less than critical distances. Linear interpolation is allowed for intermediate anchor spacing between critical and minimum distances. Multiple reduction factors for anchor spacing may be required depending on the anchor group configuration.

MECHANICAL ANCHORS

MINI DROPIN™

Internally Threaded Expansion Anchor

LOAD ADJUSTMENT FACTORS FOR NORMAL-WEIGHT AND LIGHTWEIGHT CONCRETE

Spacing, Tension (F_{Ns}) & Shear (F_{Vs}) (Normal-weight & Lightweight Concrete over deck)

Dia. (in.)	1/4	3/8	1/2	
h_v (in.)	5/8	3/4	1	
s_{cr} (in.)	1-7/8	2-1/4	3	
s_{min} (in.)	1	1-1/8	1-1/2	
Spacing, s (in.)	1	0.50		
	1-1/8	0.60	0.50	
	1-1/2	0.80	0.67	0.50
	1-7/8	1.00	0.83	0.63
	2		0.89	0.67
	2-1/4		1.00	0.75
	2-1/2			0.83
	3			1.00

Notes: For anchors loaded in tension and shear, the critical spacing (s_{cr}) is equal to 3 embedment depths ($3h_v$) at which the anchor achieves 100% of load.

Minimum spacing (s_{min}) is equal to 1.5 embedment depths ($1.5h_v$) at which the anchor achieves 50% of load.

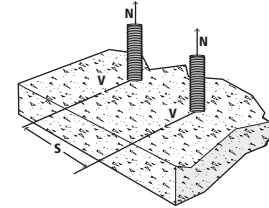

Edge Distance, Tension (F_{NC}) (Normal-weight concrete only)

Dia. (in.)	1/4	3/8	1/2	
c_{cr} (in.)	3	4-1/2	6	
c_{min} (in.)	1-1/2	2-1/4	3	
Edge Distance, c (in.)	1-1/2	0.90		
	2	0.93		
	2-1/4	0.95	0.90	
	2-1/2	0.97	0.91	
	3	1.00	0.93	0.90
	4		0.98	0.93
	4-1/2		1.00	0.95
	5			0.97
	6			1.00

Notes: For anchors loaded in tension, the critical edge distance (c_{cr}) is equal to 12 anchor diameters (12d) at which the anchor achieves 100% of load.

Minimum edge distance (c_{min}) is equal to 6 anchor diameters (6d) at which the anchor achieves 90% of load.

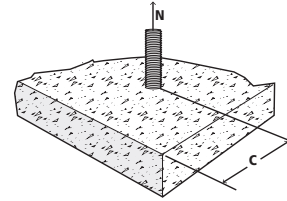

Edge Distance, Shear (F_{VC}) (Normal-weight concrete only)

Dia. (in.)	1/4	3/8	1/2	
c_{cr} (in.)	3	4-1/2	6	
c_{min} (in.)	1-1/2	2-1/4	3	
Edge Distance, c (in.)	1-1/2	0.75		
	2	0.83		
	2-1/4	0.88	0.75	
	2-1/2	0.92	0.78	
	3	1.00	0.83	0.75
	4		0.94	0.83
	4-1/2		1.00	0.88
	5			0.92
	6			1.00

Notes: For anchors loaded in shear, the critical edge distance (c_{cr}) is equal to 12 anchor diameters (12d) at which the anchor achieves 100% of load.

Minimum edge distance (c_{min}) is equal to 6 anchor diameters (6d) at which the anchor achieves 75% of load.

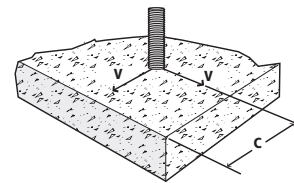

ORDERING INFORMATION

Carbon Steel Mini Dropin

Cat No.	Rod/Anchor Dia.	Drill Diameter	Overall Length	Standard Box	Standard Ctn.
6335	1/4"	3/8"	5/8"	100	1,000
6322	3/8"	1/2"	3/4"	100	1,000
6337	1/2"	5/8"	1"	50	250



Setting Tool for Mini Dropin

Cat No.	Mini Dropin Size	Standard Box	Standard Cartoon
6336	1/4"	1	50
6323	3/8"	1	50
6338	1/2"	1	50



Accu-Bit™ Drill Stop for Mini Dropin

Cat No.	Rod/Anchor Size	Drill Depth	Standard Box
00392	3/8" Accu-Bit for 1/4" Mini Dropin	7/8"	1
00398	1/2" Accu-Bit for 3/8" Mini Dropin	15/16"	1
00411	5/8" Accu-Bit for 1/2" Mini Dropin	1-13/32"	1

