



LED InstantFit Lamps

8.5T8/24-4000 IF 10/1

Philips LED T8 InstantFit Lamps are an ideal energy saving choice for existing linear fluorescent fixtures.

Product data

General Information		Power Factor (Nom)	0.9
Cap-Base	G13 [Medium Bi-Pin Fluorescent]	Voltage (Nom)	120-277 V
Main Application	Industrial	Temperature	
Nominal Lifetime (Nom)	40000 h	T-Ambient (Max)	45 °C
Switching Cycle	50000X	T-Ambient (Min)	-20 °C
B50L70	40000 h	T-Storage (Max)	65 °C
Light Technical		T-Storage (Min)	-40 °C
Color Code	840 [CCT of 4000K]	T-Case Maximum (Nom)	50 °C
Beam Angle (Nom)	160 °	Controls and Dimming	
Luminous Flux (Nom)	1050 lm	Dimmable	No
Luminous Flux (Rated) (Nom)	1050 lm	Mechanical and Housing	
Rated Beam Angle	160 °	Product Length	600 mm
Correlated Color Temperature (Nom)	4000 K	Approval and Application	
Color Consistency	<6	Energy Saving Product	Yes
Color Rendering Index (Nom)	83	Suitable For Accent Lighting	No
LLMF At End Of Nominal Lifetime (Nom)	70 %	Energy Efficiency Label (EEL)	A+
Operating and Electrical		Approval Marks	CE marking UL certificate RoHS compliance KEMA Keur certificate
Input Frequency	50 to 60 Hz	Energy Consumption kWh/1000 h	8.5 kWh
Power (Rated) (Nom)	8.5 W		
Lamp Current (Nom)	115 mA		
Starting Time (Nom)	0.5 s		
Warm Up Time to 60% Light (Nom)	instant full light s		

LED InstantFit Lamps

Product Data

Order product name	8.5T8/24-4000 IF 10/1
EAN/UPC - Product	046677452032
Order code	929001118104
Numerator - Quantity Per Pack	1

Numerator - Packs per outer box	10
Material Nr. (12NC)	929001118104
Net Weight (Piece)	0.174 kg

Warnings and Safety

- Philips LED T8 InstantFit lamps will only operate properly on compatible instant-start ballasts. Please refer to the Philips LED T8 InstantFit Installation Guide, which can be obtained through your local Philips Sales Representative, or visit www.philips.com/tled

Dimensional drawing

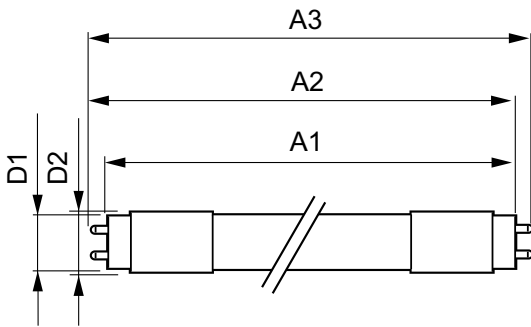

LEDtube 600mm 8.5W/840

Product	D1	D2	A1	A2	A3
8.5T8/24-4000 IF 10/1	25.68 mm	28 mm	588.5 mm	595.5 mm	602.5 mm

Photometric data

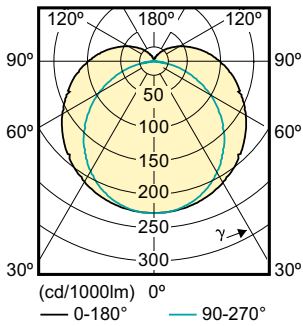

LEDtube 600 mm 8.5 W /840

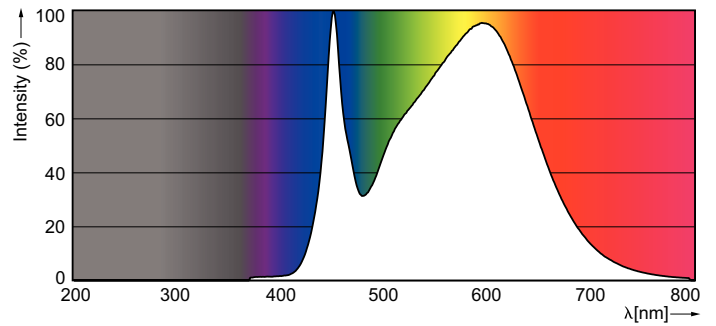

LEDtube 600 mm 8.5 W /840

