



The Original

RAM BIT

Plastic Fitting Saver

Works on PVC or ABS Fittings

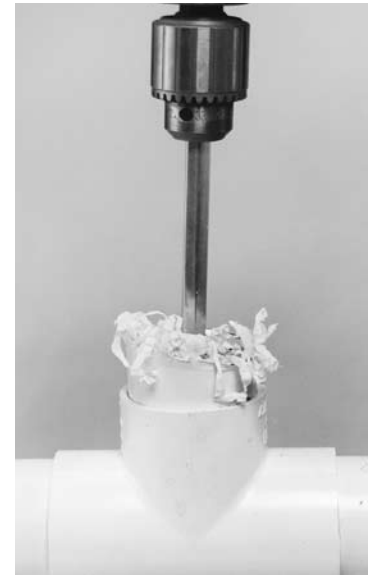

Makes in-line repairs and installations.
Reams plastic pipe squarely and accurately below the surface or finished grade.
Ram Bit leaves fittings clean and ready for solvent welding.

SAVES

- Plastic Fittings
- Welded Ball Valves

SAVES TIME

- Cuts 3" & 4" DWV flush, below slab or sub-floor
- Repairing irrigation and swimming pool manifolds
- Repairing sprinkler risers
- Repairing freeze damaged plastic pipe

Made in U.S.A.



RAMBIT



Works On:
ABS DWV, PVC DWV,
PVC PRESSURE, CPVC,
RIGID PVC ELECTRIC CONDUCT



PART NUMBER	SIZE	CLASS 200*	SCH 40	SCH 80	DRILL SIZE
3237	1/2"		✓	✓	3/8" or heavy duty 3/8" rechargeable
3239	3/4"	✓	✓	✓	
3241	1"	✓	✓	✓	
3242	1-1/4"	✓	✓	✓	
3243	1-1/2"	✓	✓	✓	
3244	2"	✓	✓	✓	
3253	3"	✓	✓		1/2" variable
3254	4"		✓		

Replacement Parts

SIZE	BLADE ONLY	ARBOR W/NUT
1/2"	3204	3200
3/4"	3208	3200
1"	3213	3200
1-1/4"	3219	3201
1-1/2"	3225	3201
2"	3231	3201
3"	3256	3252
4"	3262	3252



The Drain Key™

Removes Corroded Bath Tub Drains

U.S. Patent 6,282,999

It's unique expanding design allows The Drain Key to internally grip in a 360° pattern. The drain Key's steel shoes will not mar chrome or special finishes. Installs and removes tub drains, closet spuds and pipe nipples.

Expands with a crescent wrench to unlock or install:

- Bathtub drains
- 1-1/4" or 1-1/2" Trap (dirty arm) nipples
- 1-1/4" or 1-1/2" closet spuds
- Jr. basket strainers, Jr. duo strainers, tray plug drains and duplex strainers

*Interchangeable steel Drain Key™ shoes sold separately

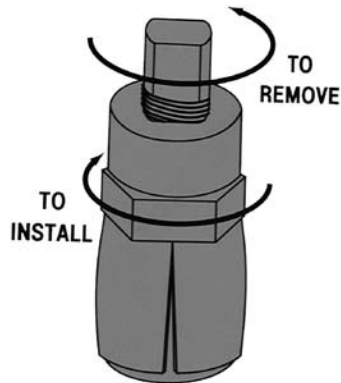

PART NUMBER	VOLTS
4500	Drain Key
4508	Replacement set of 3 shoes only

Smart Dumbbell - The Original

The Original and Still The Best!

Fits all 17 modern tub drain configurations

Installs and removes tub drains and closet spuds



- Installs or removes drains without crossbars (Kohler, American Standard)
- Heavy duty die-cast aluminum
- Prevents scratching of decorative finishes
- Either a crescent wrench or large phillips screwdriver can be used to turn the tool
- Saves time, money and aggravation
- 6" length

Made in U.S.A.

PART NUMBER
4554



Quick Nutcracker - The Original

Quickly removes corroded 1/2" zinc locknuts from faucet shanks.

- Heat treated cutter blades
- Ball thrust bearings
- Durable black oxide finish
- Will work on faucet shanks with only three threads showing

For use on:

- 1/2" Shank single basin faucet
- 1/2" Shank centerset faucet
- 1/2" Shank kitchen faucets



U.S. Patent 4,365,413



PART NUMBER	VOLTS
7000	Nutcracker ONLY
7012	10" Extension ONLY
7014	3/8" Ratchet ONLY
7010	Nutcracker Ratchet & Extension

Moen® Stem and Cartridge Puller - The Original

Removes Moen® stems and Moen® cartridges from faucets and shower valves. Also removes the Posi-Temp® tub/shower cartridge.

- Removes brass cartridges
- Removes brass stems
- Removes plastic stems & cartridges
- Precision made
- High quality steel components
- One piece construction
- Easy to use



PART NUMBER
7040



KWIK TITE WRENCH

Get a grip on the installation of angle stops with these two plumber designed tools.

The larger forged steel socket “opens” to attach to an angle stop.
The smaller forged steel socket “opens” to attach to a 3/8” outlet supply nut.



#4524 9” Length

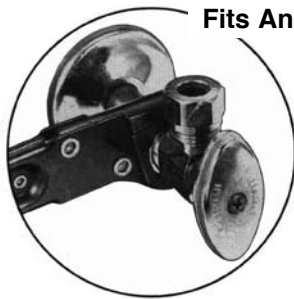

Fits Angle Stop

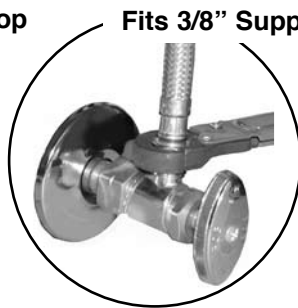

Fits 3/8” Supply Nut

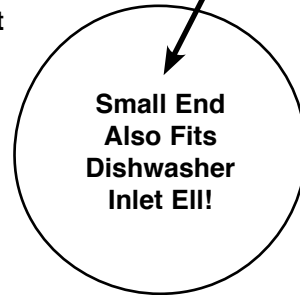

Small End Also Fits Dishwasher Inlet EII!

Don't forget to use with the ANGLE-ON WRENCH

- Fits 3/8” or 1/2” MPT compression outlet threads on angle stops.
- Help protect special finishes. Nickel plated steel and precision machined.



#4525 6” Length

Made in U.S.A.

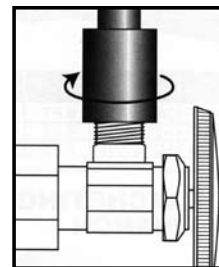

Remove outlet nut and screw on Angle-On

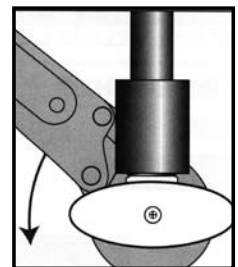

Angle-On acts as a lever for tightening compression angle stops.

PART NUMBER	DESCRIPTION
4524	Dual Kwik Tite Wrench ONLY
4525	Angle-On Wrench ONLY
4528	Dual Kwik Tite Wrench & Angle-On Wrench packaged together



Compression Sleeve Puller

Heavy duty - For 1/2" copper tubing

ALL NEW DESIGN!

- Fully machined body and screw
- Lifetime guarantee not to bend or break
- Designed by plumbing professionals
- Use 3/4" socket



shown in use



Re-designed bullet nose will not pull off

Made in U.S.A.

PART NUMBER
4661

Compression Sleeve Puller

Heavy duty - For 1/2" copper tubing

- Use 3/8" ratchet
- With 3/4" socket
- Removes compressed brass sleeves
- Precision machined
- Extremely durable
- Designed by plumbing professionals

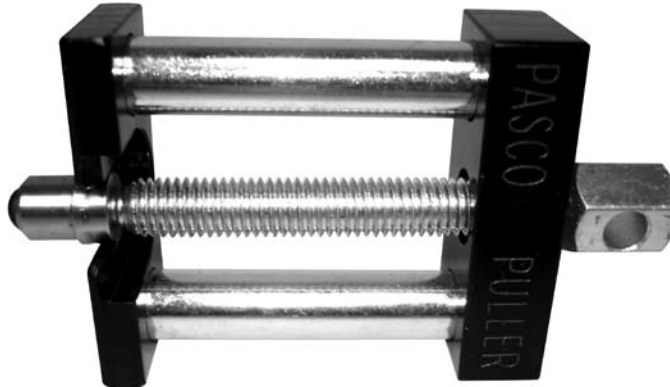

PART NUMBER
4665

Compression Sleeve Puller

Economical for use with handle puller

- This unique tool, combines with a Big Yank handle puller (# 4659) removes installed 1/2" copper compression sleeves and nuts.
- Sleeve puller and handle sold separately.



Made in U.S.A.

PART NUMBER
4655



Introducing The New EASY-CUT JAWS

NEW

**Easily cuts die cast, brass and plastic locknuts from 1/2" faucet shanks
From the company that introduced the "Quick Nutcracker"**

EASY-CUT JAWS works with any power drill chuck to safely and quickly cut away faucet mounting nuts. The tool allows a plumber to remove a faucet from a sink or countertop in minutes rather than hours.

EASY-CUT JAWS

- Is a quality professionally engineered tool.
- Has a hardened steel hex end that fits into any drill chuck.
- Has a built-in spring loaded patented safety chip-guard.
- Uses a heat treated bi-metal cutter that cuts through brass, steel and plastic faucet mounting nuts.
- Works on all faucets brands that have 1/2" water supply shanks.

U.S. Patent 6,629,804



Attach **EASY-CUT JAWS** tool to drill motor.

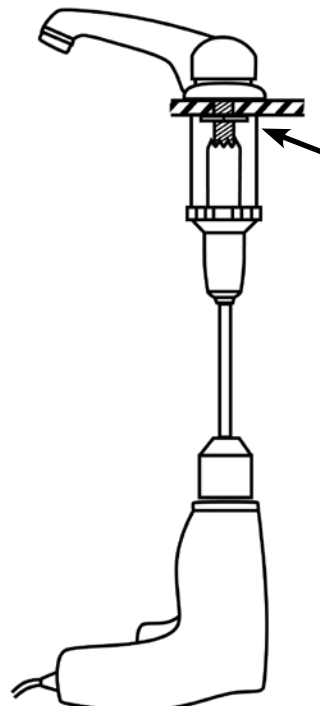
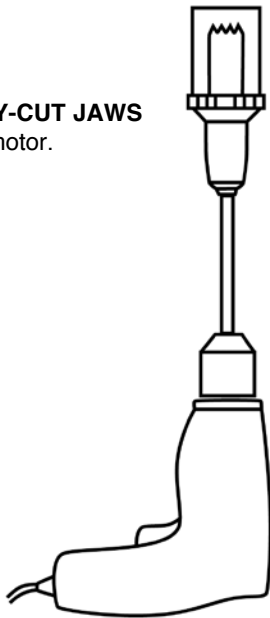

Position **EASY-CUT JAWS** over faucet shank with the clear chip guard in contact with the sink or countertop.

Operate drill motor at a slow, safe speed applying a light steady upward force to cut away the mounting hardware.

Cutting chips will accumulate inside the chip guard. Empty guard after each cut.

Made in U.S.A.

**PART
NUMBER
7018**



Quick Sweat

**Plumber
Designed!**

Patent Number 5,819,804

- Flexible 24" steel cables will slide through elbows and are interchangeable with the handle to fit different size copper.
- Durable polypropylene handle will fit 1/2" thru 2" cables.
- Long lasting elastomeric plug
- Eliminates "bread" and outperforms all the rest.

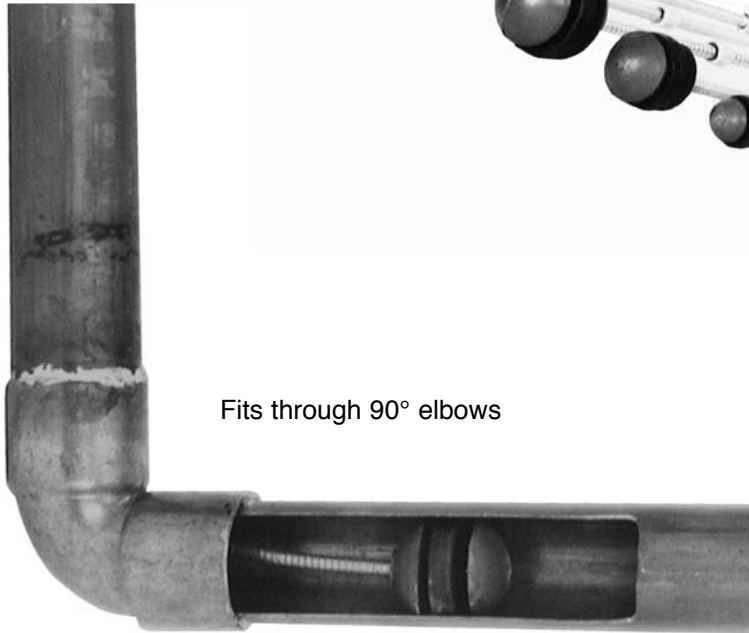

Fits through 90° elbows

PART NUMBER	SIZE
51500	Kit including: Handle & 1-each 1/2", 3/4", 1" cables
51050	1/2" Complete tool
51075	3/4" Complete tool
51100	1" Complete tool
51125	1-1/4" Complete tool
51150	1-1/2" Complete tool
51200	2" Complete tool
51040	Handle ONLY
51012	1/2" Cable ONLY
51034	3/4" Cable ONLY
51010	1" Cable ONLY
51114	1-1/4" Cable ONLY
51115	1-1/2" Cable ONLY
51120	2" Cable ONLY

Made in U.S.A.



Price Pfister® Special Shower Valve Socket Wrench

Fits both bonnet and packing nuts on Price-Pfister® Shower Valve Stems.

- Fits 31/32" stem bonnet nuts
- Fits 27/32" stem packing nuts
- 50% longer than regular shower valve wrenches
- Overall length allows socket to reach well into tile covered walls



PART NUMBER
5310

Made in U.S.A.

Classic Drain Wrench

Tightens most fiberglass shower stall drain locknuts and die cast basket strainer locknuts.

- Fits 3-1/2" plastic locknuts
- Fits 3-3/8" die cast basket strainer locknuts
- Fits brass locknuts on brass shower stall drains
- Stamped steel
- 13" overall length
- Offset handle for close quarter work
- Cushion grip



PART NUMBER
7095

Made in U.S.A.

No-Hub Torque Wrench 60 Inch Pounds

- Measures torque when turned in a clockwise direction & ratchets when turned counterclockwise
- Retractable reversing lever
- Chrome vanadium socket



- Tested to tighten up to 10,000 no-hub couplings*

**Test results available*

PART NUMBER	SIZE	LENGTH
7020	5/16"	6"

Quick Set Drain Wrench

- Tightens or removes shower drains with internal locknut, (like our #7980)
- 10" overall length
- Plastic coated handle



PART NUMBER
7099



Pedestal Sink Wrench

- Offset design allows user to reach tailpiece and trap slip joint nuts
- Permits trap and drain line installation or removal with pedestal sink in place.

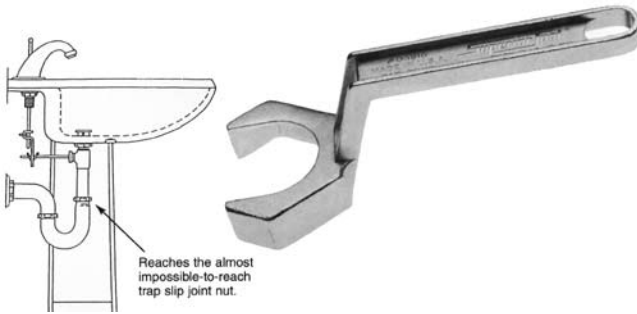

Patent Pending

PART NUMBER	SIZE
43914	1-1/4"
43915	1-1/2"

Made in U.S.A.

Plumbers Combo Wrench

This all new wrench combines the features of 4 similar wrenches, including the Super Wrench. Designed for use on:

- Closet spuds
- Urinal spuds
- Kitchen basket strainers
- Urinal flush valves
- Compact 10" length



PART NUMBER
4556

Made in U.S.A.

Big Yank - The Original

- Removes large and small handles
- Economical yet tough
- One piece forged drive bracket
- 4" bracket width
- 5" gripper fingers



PART NUMBER
4659

Made in U.S.A.

Big Yank Sr.™ - The Original

The only handle puller that grips faucet handles with 3 fingers!

- One piece forged drive bracket
- Notches in bracket keeps fingers from sliding apart
- Engineered for the professional
- 5" gripper fingers



PART NUMBER
4668



Meter Key Socket Head

Make any length meter key using 1/2" IPS threaded pipe and this socket



PART NUMBER
4059

Made in U.S.A.

Water Meter Box Key

- Brass
- Fits most locks

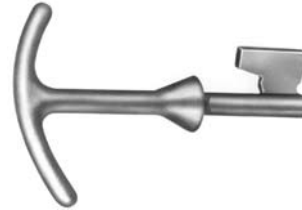

PART NUMBER
4074

Water Meter Key

All new lightweight design!
This key is designed for valves that are hard to turn

- Minimum order of 5 keys required
- Heavy duty

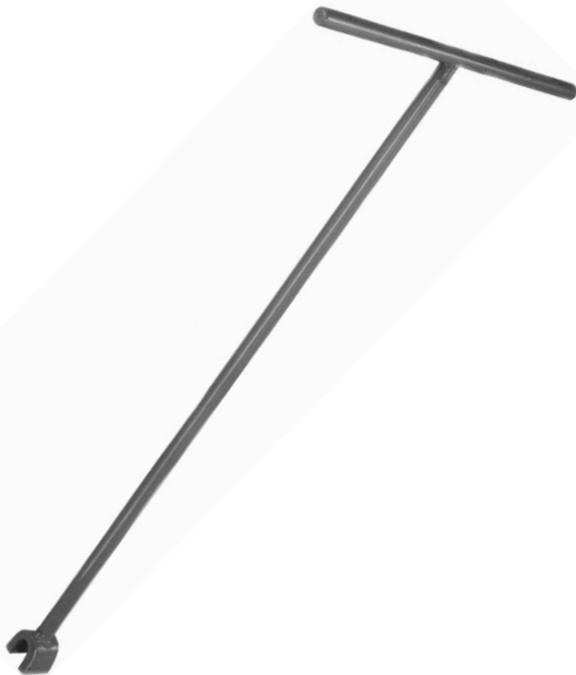

Made in U.S.A.

PART NUMBER	SHAFT DIAMETER	LENGTH	HANDLE LENGTH
4061	5/8"	60"	14"
4089	3/4"	42"	14"

Plumber's Air Pump

- Made of virtually unbreakable polyethylene
- 1-1/4" one piece barrel permits a large volume of air
- 48" Non-kinking hose
- Quick connect thumb valve
- Large easy grip handle
- 2" 0-150PSI gauge
- Easy to read RED pressure range arrow.



We drove our truck over this pump and it STILL WORKS!

PART NUMBER
1424



Journeyman Plastic Pipe Saws - The Original

Since 1973

- Cuts PVC, ABS, wood and drywall
- Unbreakable aluminum die cast handle
- Large, comfortable grip
- Flame hardened blade
- The best saw of its kind in the trade

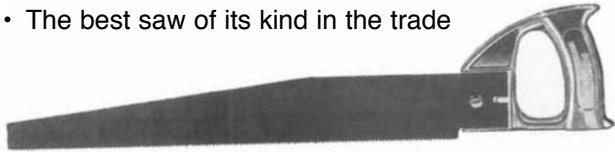

Handle Made in U.S.A.

PART NUMBER	DESCRIPTION
4331	Complete "Mity Mite" Saw
4331-B	13" "Mity Mite" Blade
4333	Complete "Journeyman" Saw
4333-B	18" "Journeyman" Blade
4333-H	"Journeyman" Saw Handle

Push Stroke Cutting Action

- Cuts plastic pipe and wood
- Smooth, fast and accurate cutting
- Push/pull cutting action

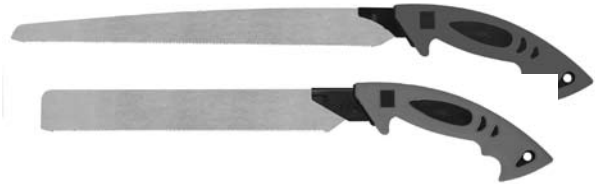

PART NUMBER	DESCRIPTION
4338	Saw w/12" Blade
4338-B	12" Blade
4339	Saw w/8" Blade
4339-B	8" Blade

Super Hacksaw

- Comfort front end grip
- Stores extra blades
- Cuts flush to surface



PART NUMBER	SIZE	BLADE SUPPLIED
4267	4"	12"

Hacksaw

- Adjusts to 4 lengths
- Plated frame



PART NUMBER	DEPTH	SUPPLIED	ADJUSTS
4254	2-3/4"	12"	10" to 12"

Tiny Tim Hacksaw - The Original

Since 1946

- Cuts steel & brass
- Vinyl grip handle
- Display carded
- Blades sold in reusable tube



PART NUMBER	DESCRIPTION
4290	Hacksaw w/Blade
4292	Extra Blades 10/package

Hacksaw Blades

Bi-Metal Tough Cut Blades



PART NUMBER	TEETH PER INCH	BLADE LENGTH
4217	18	12"
4218	24	12"



PVC Pipe Cutter

- Cuts up to 1" PVC Pipe - all schedules!
- Cuts up to 1" CPVC



Stock blades
and repair kits

PART NUMBER	DESCRIPTION
4657	Complete
4657-B	Blade ONLY

Pro-Cut Plastic Pipe Cutter

- Superior quality, heavy duty
- Cuts 1" plastic pipe
- Coated handles
- Built for constant use

New!



PART NUMBER	DESCRIPTION
4658	Complete
4658-B	Blade ONLY

PVC Pipe Cutter

- Cuts up to 2" PVC pipe
- Stainless steel blade



Stock blades
and repair kits

PART NUMBER	DESCRIPTION
4678	Complete
4678-B	Blade ONLY

Soft Pipe Cutter

- For cutting soft pipe and hose
- Heavy duty die cast
- Cuts up to 2" soft tubing



The best cutter
manufactured!

PART NUMBER	DESCRIPTION
4682	Complete
4682-B	Blade ONLY

PVC Cable Saw

For fast cutting of PVC
and irrigation pipe

- 24" Stainless steel cable
- Great for tight spots, need only 1/4" clearance
- Easily stored
- 30" Overall

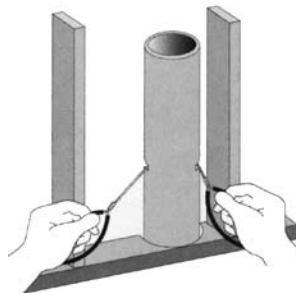

Made in U.S.A.

PART NUMBER	DESCRIPTION
4336-S	Strip pack of 12

Inside Plastic Pipe Cutter

- Fits 3/8" and larger drills



PART NUMBER	DESCRIPTION
3290	Pipe Cutter
3290-B	2 Blades per pack



Bi-Metal Tough Cut Reciprocating Saw Blades

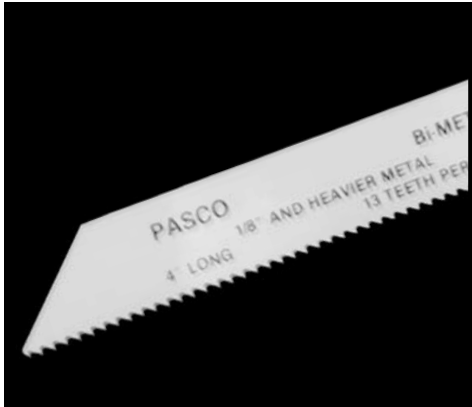

PART NUMBER	LENGTH	TEETH PER INCH	USAGE RANK	CUTS THESE MATERIALS
3809	6"	10T	#8	Light, Non-ferrous metals, nail embedded woods, cast aluminum.
3810	6"	14T	#2	Heavy guage metals, 1/8" conduit, pipe, tubing and galvanized pipe.
3811	6"	18T	#3	Metals to 1/8". Conduit, pipe, tubing and galvanized pipe.
3812	6"	24T	#5	Finer teeth for faster cutting of metal to 1/8", galvanized pipe.



PART NUMBER	LENGTH	TEETH PER INCH	USAGE RANK	CUTS THESE MATERIALS
3820	9"	10/14T	#4	.050 Thick x 3/4" Wide super model for cast iron pipe. Teeth vary alternately from 10 to 14 per inch which reduces vibration and makes smoother cuts.



PART NUMBER	LENGTH	TEETH PER INCH	USAGE RANK	CUTS THESE MATERIALS
3813	6"	6T	#1	Fast cutting of all woods, nail embedded general roughing work.
3816	12"	6T	#7	Same as #3813 above



PART NUMBER	LENGTH	TEETH PER INCH	USAGE RANK	CUTS THESE MATERIALS
3814	8"	10T	#6	All woods, composition, plastics, 4" diameter pipe, cast iron, nail embedded woods, general metal cutting, fiberglass.



PART NUMBER	LENGTH	TEETH PER INCH	USAGE RANK	CUTS THESE MATERIALS
3808	6"	6T	#11	Plastic, lath, sheet rock, fiber board, particle board.



Reciprocating Saw Blade - Carbide Grit

- 3/4" Width
- Fits most reciprocating saws
- Flexible alloy steel
- Diamond hard tungsten carbide grit makes this blade last up to 20 times longer than conventional reciprocating blades

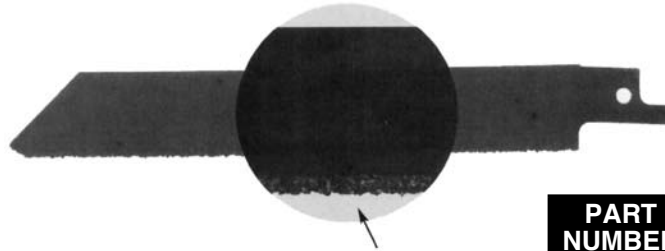

PART NUMBER	SIZE	SIZE
3835	6"	Medium
3845	9"	Medium

Carbide Hole Saw

- Cuts ceramic tile, stainless steel.
- Complete with D-Drive arbor and carbide drill.



PART NUMBER	DESCRIPTION
3912	1-1/4"
3913	1-3/8"
3915	1-3/4"
3916	Arbor w/carbide drill

Auger Bits

PASCO Auger bits are precision made of special bit steel, heat treated and tempered for long life.

Extra Long



HEAVY DUTY SHIP

- 6-1/2" Length
- 4" Twist
- 7/16" Shank

PART NUMBER	SIZE
3851	3/4"
3853	7/8"
3855	1"
3857	1-1/8"
3858	1-1/4"
3859	1-3/8"
3860	1-1/2"

EXTRA LONG

- 18" Length
- 12" Twist
- 7/16" Shank

PART NUMBER	SIZE
3865	3/4"
3867	7/8"
3868	15/16"
3869	1"
3871	1-1/8"
3872	1-1/4"
3873	1-3/8"
3874	1-1/2"

Swedging Tool

- For "M" Copper tubing

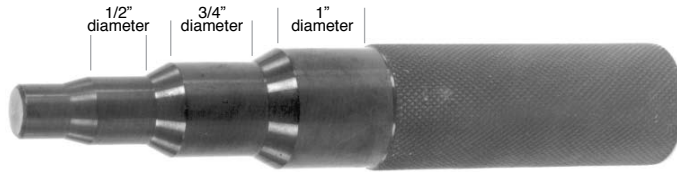

PART NUMBER	SIZE
4330	1/2" - 3/4" - 1"

Copper Sizing Tools

- Impact type to re-round copper tubing
- For "M" Copper tubing

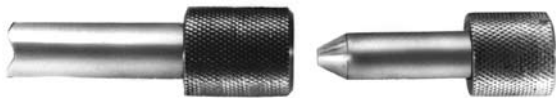

PART NUMBER	SIZE
4343	1/2"
4344	3/4"
4345	1"

Copper Deburring Tool - Reamer

- Die Cast
- Deburrs up to 1-1/4" copper or CPVC



PART NUMBER	SIZE
4356	Metal

Economy Flaring Tool

- For O.D. sizes:
- 3/16", 1/4", 5/16", 3/8", 1/2", 5/8"
- Makes smooth flare



PART NUMBER
4360

Copper Tube Flare Punches

- Soft copper tubing



PART NUMBER	SIZE
4367	3/4"
4368	1"



Copper, Brass & Stainless Steel Tubing Cutter

- Superior quality
- Enclosed feed mechanism
- Removable deburring tool located inside cutter frame
- Cuts up to 1-1/2"
- Spare blade in handle



PART NUMBER	DESCRIPTION
37610	Cuts up to 1-1/2"

Mini Tubing Cutter

- Cuts up to 1" copper
- Grooved rollers

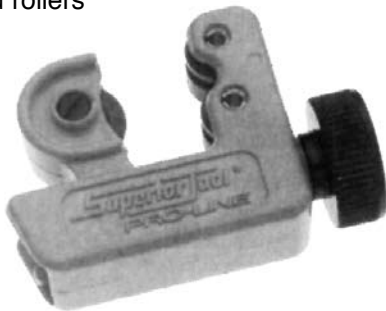

PART NUMBER	DESCRIPTION
35180	Cuts 1/8" - 1" Tubing
42835	Separate Cutter Wheel

Made in U.S.A.

Tubing and Pipe Cutter

- Cuts 1" IPS or 2" Copper
- Strong, yet lightweight
- Non-slip grip

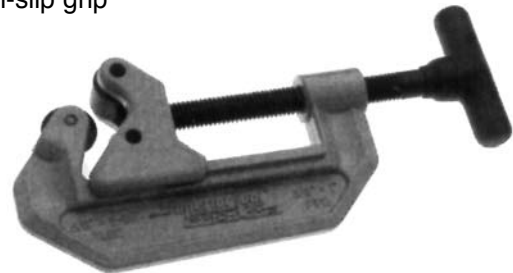

PART NUMBER	DESCRIPTION
36878	Cuts 5/8" - 1" IPS or 2" CWT
42348	Separate Cutter Wheel

Made in U.S.A.

Economy Tubing Cutter

- Grooved roller
- Retractable reamer



PART NUMBER	DESCRIPTION
4350	Cuts 1/8" to 1" Tubing
4349	Blades

Mini Tubing Cutter

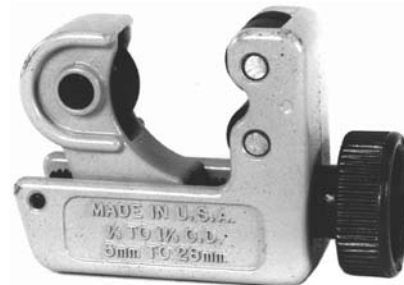

PART NUMBER	DESCRIPTION
4351	Cuts 1/8" to 1/2" Tubing



Chip and Oil Brush



PART NUMBER	SIZE
4647	1"
4649	2"

Natural Bristle Acid Brushes

- #1, #2, #4 Brushes sold 144 pieces per box
- #7 Brushes sold 36 pieces per box



PART NUMBER	SIZE	HANDLE MATERIAL	HANDLE LENGTH
46501	#1	Metal	5-1/4"
46512	#2	Metal	5-1/2"
46524	#3	Metal	6-7/8"
46537	#7	Wood	5-13/16"

Wire Brushes



Made in U.S.A.

PART NUMBER	SIZE	HANDLE
4480	3 Rows of 19 Tufts	Long
4482	3 Rows of 19 Tufts	Short

Aviation Snips

- Hand guards
- Cushion grips
- Forged blades



Made in U.S.A.

PART NUMBER	SIZE	CUT	DIRECTION OF CUT
4340	10"	1-1/2"	Left
4341			Right
4342			Straight

Copper Pipe Deburring Tools with Plastic Handles

Pen Style with Pocket Clip

Sold with 4 extra blades stored in the handle



PART NUMBER	STYLE
5103	Pen Style

PART NUMBER	STYLE
5104	Tool w/ 4 Blades
5105	5 Blades per Pack



Economy Copper Fitting Brush



- Wire loop handle
- 2-Ply carbon steel bristles
- For bulk pricing add - BLK to part number

PART NUMBER	SIZE
5139	1/2"
5141	3/4"
5143	1"
5144	1-1/4"
5145	1-1/2"
5146	2"

Made in U.S.A.

"A" Quality Copper Fitting Brush

- 2 Wire model
- High carbon crimped
- Steel bristles



PART NUMBER	SIZE
5113	3/8"
5114	1/2"
5116	3/4"
5118	1"
5119	1-1/4"
5120	1-1/2"
5121	2"

Made in U.S.A.

"AA" Quality Copper Fitting Brush

- Highest quality available
- 4 Wire model
- Double construction from stainless steel wire



PART NUMBER	SIZE
5126	1/4"
5128	3/8"
5130	1/2"
5131	3/4"
5132	1"
5133	1-1/4"

Made in U.S.A.

4-in-1 Fitting Brush

- Tube cleaning and fitting brush
- High impact plastic & high carbon steel bristles
- Replaceable brushes
- 1/2" and 3/4" copper



PART NUMBER	DESCRIPTION
5150	Complete 4-in-1 Brush
5150-R	Replacement brush kit includes 2 ID & 2 OD brushes

Made in U.S.A.

Plumbers Sand Cloth

Specially formulated for use in preparing copper fittings and tubing for soldering 120 grit aluminum oxide.



PART NUMBER	SIZE
3102	10 Yards

Plumbers Open Mesh Sand Cloth

- Waterproof
- 180 Grit
- Aluminum oxide

7.5 Yards
New More
Convenient
Size

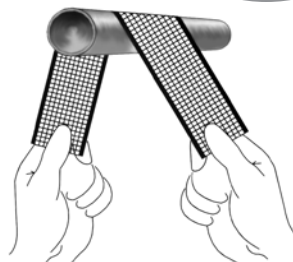

PART NUMBER	SIZE
3108	7.5 Yards

Copper Tube Brush

- The finest manufactured
- Cleans copper water tube end for soldering



Sizes indicated are nominal copper

PART NUMBER	SIZE
5153	1/2"
5155	3/4"
5157	1"

Made in U.S.A.



Nipple Boxes

- Holds CL thru 6" nipples
- Fold away handle
- Epoxy coated steel
- Light weight yet strong



Made in U.S.A.

PART NUMBER	SIZE	HOLDS
3080	1/2"	77
3081	3/4"	66
3082	1"	50
3083	1-1/4"	40
3084	1-1/2"	30
3085	2"	27

Fitting Tote Tray

- Excellent for copper fittings
- 18 Gauge
- 20" x 10" x 5"
- Fold away handle
- Epoxy coated steel

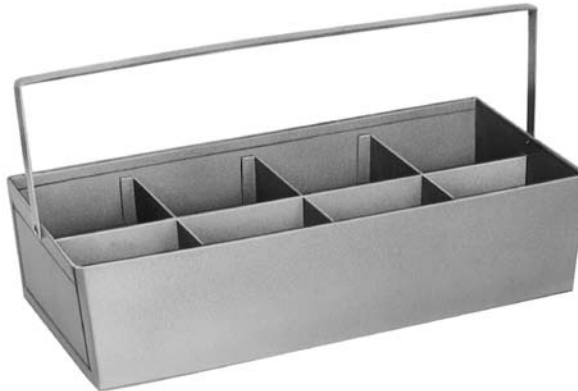

Made in U.S.A.

PART NUMBER	DESCRIPTION
3088	With 8 dividers
3088-LD	less dividers

1/2" and 3/4" Combo Nipple Box

- Holds both 1/2" and 3/4" nipples
- Holds (39) 1/2" CL thru 6"
- Holds (33) 3/4" CL thru 6"
- Fold away handle
- Epoxy coated steel



Made in U.S.A.

PART NUMBER
3091



Internal Nipple Wrench

- CAM Type
- Removes or inserts
- Heat treated
- Cadmium plated



PART NUMBER	NIPPLE SIZE
4531	1/2"
4532	3/4"
4533	1"

Internal Nipple Wrench

- Excellent for chrome work
- Precision machined and hardened
- Loosens and tightens
- Designed to grip internally
- Removes broken nipple threads from fittings



PART NUMBER	SIZES
4511	1/2" IPS Internal Wrench
4512	3/4" IPS Internal Wrench
4513	1" IPS Internal Wrench

Pipe Taps

- High carbon steel
- Tapered thread taps

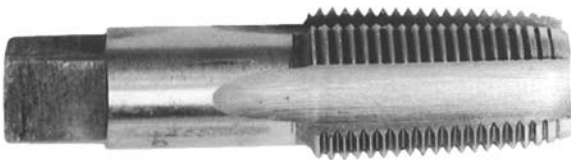

PART NUMBER	PIPE SIZE	NO. OF NPT	TAP DRILL SIZE
4812	1/8"	27	1/8"
4813	1/4"	18	7/16"
4814	3/8"	18	37/64"
4815	1/2"	14	45/64"
4816	3/4"	14	59/64"
4817	1"	11-1/2	1-5/32"
4818	1-1/4"	11-1/2	1-1/2"
4819	1-1/2"	11-1/2	1-47/64"
4820	2"	11-1/2	2-7/32"

Nipple and Screw Extractors

- Removes nipples, bolts and screws
- Left hand spiral tapered flute removes broken piece without thread damage



PART NUMBER	IND ID#	PIPE SIZE	DRILL SIZE	BOLT SCREW SIZE
4827	4	1/8"	1/4"	9/32" to 3/8"
4828	5	1/4"	19/64"	3/8" to 5/8"
4829	6	3/8"	13/32"	5/8" to 7/8"
4830	7	1/2"	17/32"	7/8" to 1-1/8"
4831	8	3/4"	13/16"	1-1/8" to 1-3/8"
4832	9	1"	1-1/16"	1-3/8" to 2"



Quick Set Pliers - “Set of Reds”

- Easily fit 1-1/2” slip joint nuts
- Forged and chromed
- Vinyl grip handles



PART NUMBER	LENGTH
4063	10”

Tongue & Groove Pliers

CHAN NEL LOCK



Made in U.S.A.

PART NUMBER	LENGTH	ADJ.	CAP
420G	9-1/2”	5	1-1/2”
422G	9-1/2”	5	1-1/2”
426G	6-1/2”	5	7/8”
430G	10”	7	2”
440G	12”	7	2-1/4”
442G	12”	7	2-1/4”
460G	16”	8	4-1/4”

Griplock®

CHAN NEL LOCK

- Ergonomically designed off-set head for greater leverage
- Permalock® fastener eliminates nut and bolt failure



Made in U.S.A.

PART NUMBER	LENGTH
GL12	12”

Plumbers Helpers

CHAN NEL LOCK

- Polished high carbon drop forged steel
- Perfectly mated cutter, heat treated to hold its edge.



Made in U.S.A.

PART NUMBER	LENGTH
317G	7-1/2”
337G	7”



Pipe Wrenches

Heavy duty, milled teeth



PART NUMBER	SIZE	FRAME	CAPAC. UP TO
4545	10"	Alloy Steel	1"
4546	14"		2"
4547	18"		2-1/2"
4548	24"		3"
4551	14"	Alum.	2"
4552	18"		2-1/2"
4553	24"		3"

Offset Ratcheting Box Wrench

Ideal for closet nuts



PART NUMBER	SIZE	OPENING	LENGTH
4497	3/8" x 7/16"	12 pt.	8"

Made in U.S.A.

Strap Wrenches

- Ideal for chrome pipe nipples
- Will not mar chrome, fittings & nipples



PART NUMBER	SIZE
4542	7"
4543	11"

Adjustable Wrenches

CHAN NEL LOCK

- Polished high carbon drop forged steel
- Perfectly mated cutter, heat treated to hold its edge.



PART NUMBER	SIZE
806	6"
808	8"
810	10"
812	12"

Made in U.S.A.



CHANNEL LOCK Wiring Tool

- Strips wire with no damage to conductor
- Crimps both insulated and non-insulated wire

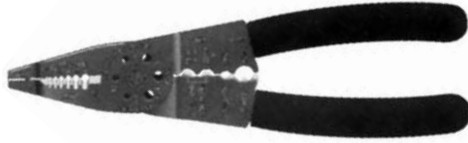

PART NUMBER	LENGTH
908G	8-1/4"

Made in U.S.A.

Wire Stripper

- Adjusting stop on the gripping handles permits adjustment for wire size
- Vinyl grip handles

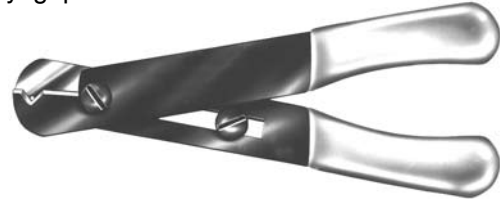

PART NUMBER
4107

Nut Drivers



PART NUMBER	SIZE
4125	3/16"
4127	1/4"
4129	5/16"
4131	3/8"
4132	7/16"
4133	1/2"
4135	9/16"

6-in-1 Screwdriver

- 1/4" Hex - 5/16" Hex
- 12 Pack display packaged

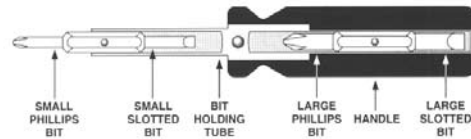

PART NUMBER	DESCRIPTION
4208	Screwdriver complete
4208-C	Carded screwdriver complete
4209	#2 Phillips x 5/16" slotted bit only
4210	#1 Phillips x 3/16" slotted bit only

Pocket Screw Driver

- With pocket clip
- Slot type blade



PART NUMBER
4192

Putty Knives

- High carbon cutlery steel
- Highly polished



PART NUMBER	BLADE
4116	Flexible
4117	Stiff

Scratch Awl



PART NUMBER
4478



“The Best” Bibb Seat Tool

- Left hand threads - sure grip



PART NUMBER

4566

Made in U.S.A.

Valve Stem Lube Heat Proof Grease

- Use on water or steam
- Apply to stems of faucets, packing, plungers, ball cocks, valves & washers
- Food grade



PART NUMBER

3155

Made in U.S.A.

Bibb Seat Tools

- For all faucet seats
- Cadmium plated
- Heat treated

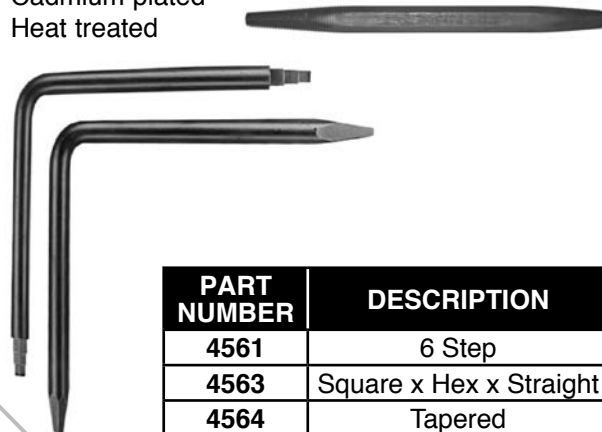

PART NUMBER	DESCRIPTION
4561	6 Step
4563	Square x Hex x Straight
4564	Tapered

Professional Faucet Reseater Kit

KIT INCLUDES:

- 4- Harden steel cutters for various size faucets
- 1- Guide cone
- 4- Faucet washers
- 1- Solid brass screw
- 1- Long shaft for tub & showers



PART NUMBER

4565

Made in U.S.A.

Bibb Seat Tool Set

SET INCLUDES:

- 1- 3/8" x 7/16" ratcheting box wrench
- 1- Small hex/large hex tapered bibb seat tool
- 1- Small square/large square no taper bibb seat tool



PART NUMBER

4568

Packed in a sturdy, sealable plastic case.

Regular Basin Wrench

- For use on basin nuts, ballcocks & flush valves
- Cadmium plated
- Jaw has springs
- Swivel head operates right or left



PART NUMBER	SIZE
4574	11"
4590	15"



Impact Handle Puller



PART NUMBER
4660

Telescoping Basin Wrench

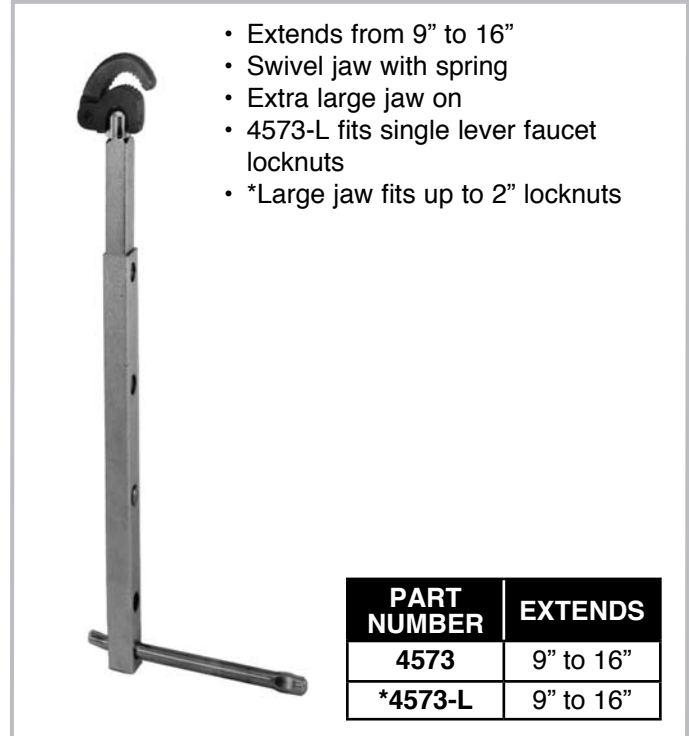

- Extends from 9" to 16"
- Swivel jaw with spring
- Extra large jaw on
- 4573-L fits single lever faucet locknuts
- *Large jaw fits up to 2" locknuts

PART NUMBER	EXTENDS
4573	9" to 16"
*4573-L	9" to 16"

Shower Valve Socket Set - Professional Quality



- Heavy duty
- Each socket is 20% longer than the import
- High quality steel

Made in U.S.A.

PART NUMBER	DESCRIPTION
5300XH	Complete Set Only

Import Shower Valve Socket Set

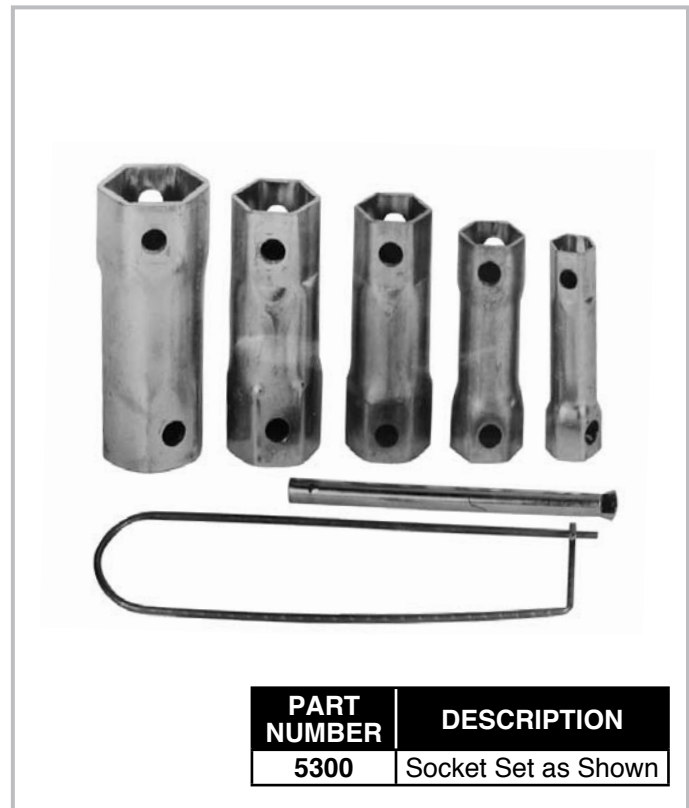

PART NUMBER	DESCRIPTION
5300	Socket Set as Shown



Hex Key Tool Caddy

- Keys are #8650 chrome nickle alloy steel
- Close tolerance assures precise fit into hex socket
- Hardened and tempered for maximum durability

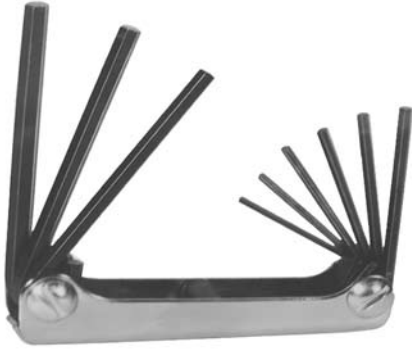

Made in U.S.A.

PART NUMBER	NO. OF KEYS	KEY SIZES
3040	9 Keys	5/64", 3/32", 7/64", 1/8", 9/64", 5/32", 3/16", 7/32", 1/4"
3041	8 Keys	.050", 1/16", 5/64", 3/32", 7/64", 1/8", 9/64", 5/32"

Hex Key Tool Caddy



PART NUMBER	KEY SIZES
4575	.28", .035", .050", 1/16", 5/64", 3/32", 7/64", 1/8", 9/64", 5/32", 3/16", 7/32", 1/4", 5/16", 3/8"

Made in U.S.A.

Radiator Air Vent Wrench 3-Way



PART NUMBER
4947

Radiator Spud Wrench



PART NUMBER
4558

New Design Heavy-Duty Hot Water Heater Element Wrench

- Now use 1/2" ratchet

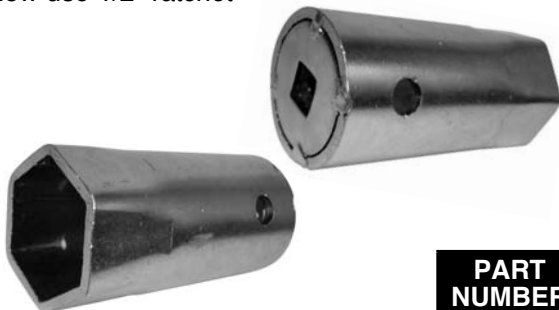

PART NUMBER
4946

Sprinkler Nipple Extractor

- For plastic risers



PART NUMBER
4498



Closet Seat Nut Wrench

- Fits any length bolt
- Fits 99% of closet seat nuts
- Die cast



Made in U.S.A.

PART NUMBER
4557

Po Plug Wrench

- Removes PO plugs and tub drains

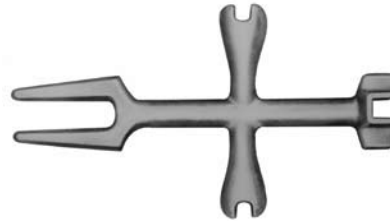

PART NUMBER
4555

4-in-1 Strainer Wrench

- Fits 3/8" strainer locknut
- 5-1/2" length
- Super tough Lexan plastic
- Slotted inserts that conveniently fit the standard slotted sink basket strainer locknuts

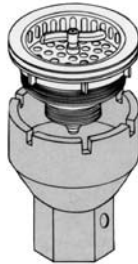

Made in U.S.A.

Tool ONLY
PART NUMBER
4948

Internal Spud Wrench

New Design

- A must to install or remove urinal and closet spud, waste and overflows
- 4" capacity
- Cushioned grip
- High quality



PART NUMBER
4562

Adjustable Spud Wrench

- 10" Length
- 1" to 3" Capacity
- For slip nuts, locknuts and strainer nuts



PART NUMBER
4571

Basket Strainer Wrench

- Zinc plated steel
- Handle slides



PART NUMBER
4949

Garbage Disposal Wrench

- For releasing jammed garbage disposers
- 1/2" Steel
- 10" Length

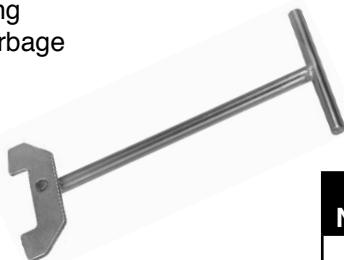

PART NUMBER
4943

Strainer Nut Wrench

See our new upgraded part #4556 on page C-10



DISCONTINUED
substitute new part #4556



“Grab All” Retrieving Tool



Magnetic Retrieving Tool



The Original Pumie® Scouring Stick

- Cleans where chemicals fail
- Removes stubborn lime, rust and drain snake marks from porcelain & ceramic
- Plastic handle style for hard to reach spots



PART NUMBER	HANDLE	DISPLAY PACK
3125	NO	12
3126	YES	6

Made in U.S.A.

Inspection Mirror



Flat Cold Chisels

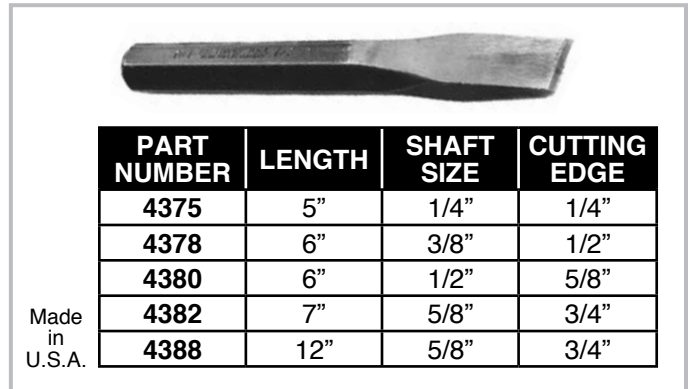

Sod/Linoleum Knife



Utility Knife

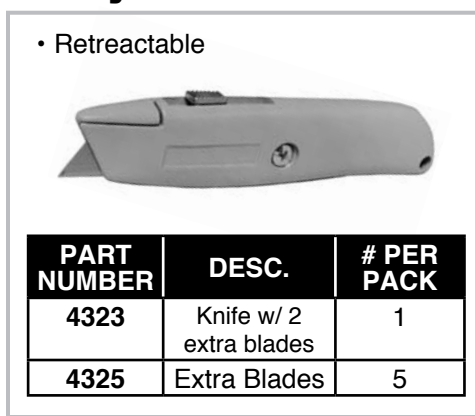

Spud Wrench





“Drop In” Half Barrel Type Caulking Gun



PART NUMBER
5100

Spring Tube Benders

- For copper, aluminum & soft thin wall tubing



PART NUMBER	SIZE	LENGTH
5160	1/4"	10"
5162	3/8"	
5164	1/2"	

Cellulose Sponges

- Excellent for drying and cleaning up
- For cleaning up tanks, lavatories, shower liners and leaking traps
- Natural color

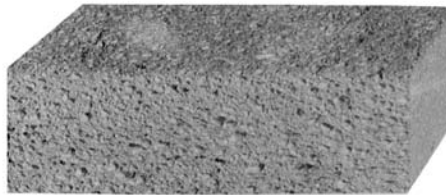

Made in U.S.A.

PART NUMBER	SIZES
5184	6" x 4-1/4" x 1-11/16"
5185	7-1/2" x 4-1/2" x 2-1/16"

Mill Bastard Files

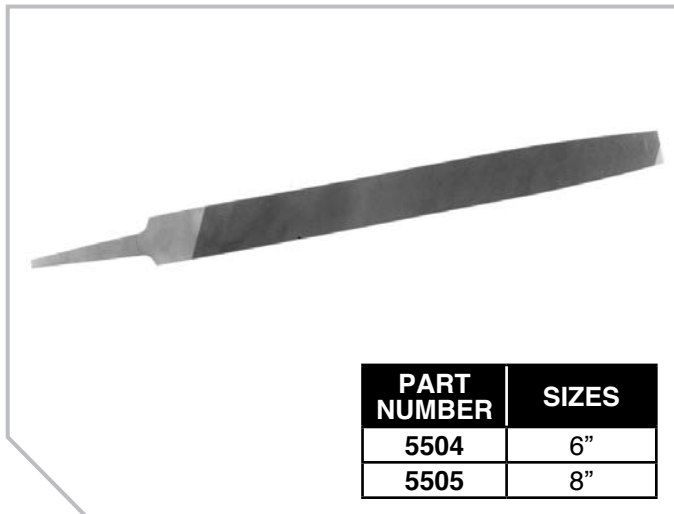

PART NUMBER	SIZES
5504	6"
5505	8"

Thread File

- Restores damaged threads on bolts and external or internal pipe threads
- Clears damaged or corroded threads
- Comes in reusable plastic tube



PART NUMBER
5562



Master Plumbers Force Cup

- Heavy duty
- Ribbed cup for strength
- Provides big "blast" for all stoppages
- High quality rubber
- 19" handle



PART NUMBER
4636

Heavy Duty Closet Bowl Force Cup

- Extra large for best pressure with positive seal
- Designed for all types of toilets
- High quality black rubber
- 19" handle



PART NUMBER
4637

Economy Force Cup

- High quality red rubber
- Available in 5" or 6" diameter
- 19" handle



PART NUMBER	SIZE
4640	5"
4641	6"



Industrial Grade Disposable Gloves

- Powder-free latex
- Sold by the box
- 100 per box



PART NUMBER
950
950XL

Wear-A-Day Disposable Gloves

- Blue, powder-free latex
- Plumber grade
- Sold by the box
- 100 per box



PART NUMBER
952
952XL

Atlas® Fit Gloves - Blue

New!

The original palm coated glove!

- Natural rubber coating
- Breathable back
- Seamless knit liner
- Outstanding grip
- Ergonomic fit
- Packed 12 pair



PART NUMBER
300M
300L
300XL

Atlas® Nitrile Tough Gloves - Black

New!

Long cuff & dark grey coating

- Grips
- Won't slip when wet
- Durable
- Resists solvent cement
- Packed 12 pair



PART NUMBER
370M
370L
370XL

Atlas® Nitrile 380 - Blue

New!

Waffle Pattern Palm

- Lint free nylon liner
- Compressed air-infused foam nitrile coating
- Waffle pattern provides good grip in wet conditions
- Heavy duty
- Packed 12 pair



PART NUMBER
380M
380L
380XL

Roadmaster Gloves

Highest quality leather driver's glove

- Rich grain cowhide
- Packed 12 pair
- Large size only



PART NUMBER
6036-L



Tom Cat Gloves

Cold weather favorite!

- Yellow fleece out glove
- Lined and rubberized with tan knit wrist
- Packed 12 pair
- Large size only



PART NUMBER
341-GL

Jersey Gloves

Cold weather favorite!

- Knit wrist in seal brown
- 9 oz. fabric
- Packed 12 pair



PART NUMBER	SIZE
403-M	Medium
403	Large

Cotton Gloves

- 8 oz. cotton glove
- Knit wrist
- Packed 12 pair
- Large size only



PART NUMBER
641

Reversible Plastic Dot Gloves

- 8 oz. cotton glove
- Knit wrist
- Use twice
- Packed 12 pair
- Large size only

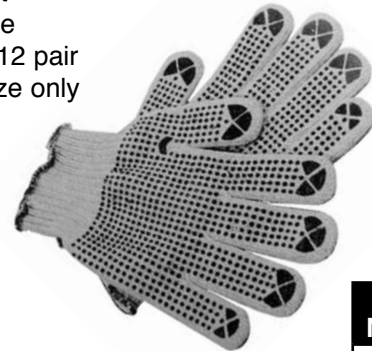

PART NUMBER
5500

Stallion Gloves

Best selling work glove in the industry

- Split leather palm glove
- Clute cut with 100% cotton fabric back
- Packed 12 pair
- Large size only



PART NUMBER
1290

Double Palm Gloves

- Wears especially well in uses such as handling a roto roter cable
- Large size only



PART NUMBER
5231-DP



Wear-A-Day Coverall

- Polypropylene
- Zipper front
- Latex free
- Elastic wrists and ankles
- 25 per case
- Sold in case quantities only



PART NUMBER
9245XL
9245XXL

Safety & Comfort Goggles

- Meets ANSI and OSHA standards



PART NUMBER
9225

Made in U.S.A.

Protective Knee Pads

- Comfortable
- Long lasting
- Codura nylon
- Foam rubber cushioning
- Flexible



9220
White plastic cap allows user to swivel and slide on working surfaces



9221
Normal natural rubber cap prevents sliding and marring

PART NUMBER	SIZE
9220	Hard protective cap
9221	Soft protective cap

Made in U.S.A.

Economy Knee Pads

- Snug and non-binding
- Comfortable when walking or kneeling
- Fully adjustable hook/loop fastener



PART NUMBER
9223

Made in U.S.A.

Disposable Shoe Covers

- Non-skid sole
- Disposable
- 10 Per pack



PART NUMBER
949



“Big Red” Tape Measure

- Unbreakable Cicolac case
- Power return
- Belt clip
- Yellow tape

New



PART NUMBER	SIZE
3945	1" x 25'

Nylon Seine Twine

- For plumb line, seine line, chalk line, mason line



Made in U.S.A.

PART NUMBER	SIZE	TEST	LENGTH
4115	#18	179 lb.	275 ft.

Torpedo Level

- Magnet and grooved
- Sturdy die cast
- Colored liquid in vials

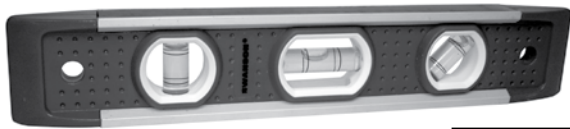

PART NUMBER
4472

Made in U.S.A.

Waterproof Lumber Crayons



PART NUMBER	COLOR
5333	Yellow
5334	Red
5335	Blue
5339	Black

Chalk and Plumb Line

- Will mark on any surface (wood, brick, stone, & metal)
- Die cast aluminum case
- Slide action lock and hook ring provides true plumb bob action
- Lock releases automatically on rewind
- Opens for easy filling of powdered chalk
- Nylon line on pop - in reel is easily replaced



PART NUMBER	SIZE
5193	100'

Made in U.S.A.

Chalk Refills

- For any chalk line reel



Made in U.S.A.

PART NUMBER	CHALK COLOR	SIZE
5195		8 oz.
5196	Red	8 oz.



Binder Twine

- 2,000 Ft.
- Sisal



PART NUMBER
4043

Truck Rope

- Polypropylene



PART NUMBER	O.D. SIZE	LENGTH
4111	3/8"	50 ft.
4112	3/8"	600 ft.

Rubber Rope

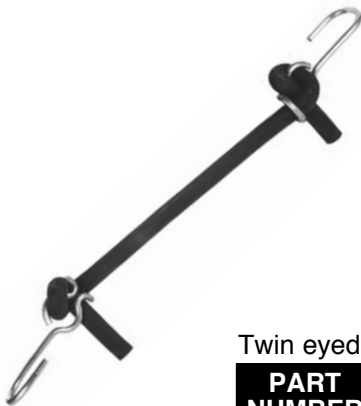

Twin eyed hooks

- 7/16" Diameter
- Make any length "tie down" you need with our rubber rope and two hooks.

PART NUMBER	LENGTH	PART NUMBER	LENGTH
6020	10	6010	10 ft.
6021	100	6012	50 ft.
		6014	150 ft.

Tie Down Straps

- Elastic rubber

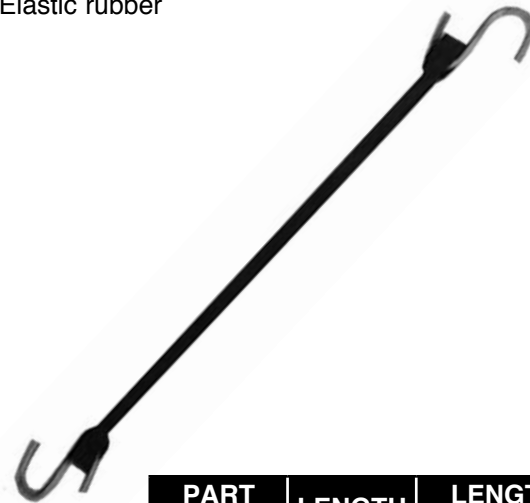

* INDICATE
-10 for 10 pack
-50 for 50 pack

PART NUMBER	LENGTH	LENGTH STRETCHED
4903*	15"	20"
4905*	20"	25"
4907*	31"	36"
4909*	41"	46"

Pro-Strap®

U.S. Patent 5,603,591

The professional tie-down strap designed by a contractor for contractors! Allows you to fasten lightweight pipe, ladders, poles & other job materials quickly & securely to your construction vehicle.

- Strong, durable, reliable. Made of black woven polypropylene webbing and industrial strength Velcro.
- Secures material in seconds in all weather conditions. No more wire twists, rubber-hooked tie downs or hard-to-untie knots.
- UV Resistant, not affected by the sun, heat or cold.

Made in U.S.A.



PART NUMBER	LENGTH
49431	43"
49721	72"



Plumbers Lead Pot



PART NUMBER	SIZE	VOLUME IN WEIGHT
4592	6"	30 lbs.

Lead Ladle



PART NUMBER	SIZE
4586	3-1/2"

Spark Lighters

- Round, Single, or Triple Flint
- Large hood traps more gas
- File rotates providing a fresh surface for the flint
- Flints good for 1,500 ignitions



PART NUMBER	DESCRIPTION	PKG.
4430	Lighter	12
4432	Extra Flints	5
4437	Shurlite Lighter	12
4438	Extra Flints	5

Made in U.S.A.

Lead Melting Furnace

- Accommodates 6" to 8" lead pots
- Works off direct propane cylinder pressure
- Fits 3" cylinder spud
- Stand converts furnace to free standing unit
- 1/4" I.P.T. connections
- Hose not supplied



PART NUMBER	DESCRIPTION
4597	furnace without stand
4599	stand with valve

Caulking Tools

- For lead & oakum



PART NUMBER	DESCRIPTION
4442	5/8" x 7" Inside caulker
4443	5/8" x 7" Outside caulker
4444	5/8" x 7" Straight caulker
4446	1-1/2" Curved board caulker
4447	5/8" x 12" Offset yarning iron
4448	5/8" x 16" Spring yarning iron

Made in U.S.A.

Lead Joint Runners

- Non-asbestos



PART NUMBER	RUNNER SIZE	FOR SOIL PIPE SIZE
4576	#1	2" to 4"
4577	#2	4" to 6"



RAYOVAC batteries are “Sealed in Steel” to meet the demands of industry for longer storage life and are guaranteed against leakage.

Alkaline Batteries



PART NUMBER	VOLTS	SIZE
261	1-1/2	C
262	1-1/2	D
263	—	AAA
264	1-1/2	AA
279	9	Trans

Heavy Duty Batteries



PART NUMBER	VOLTS	SIZE
287	9	Trans
500	1-1/2	AA
700	1-1/2	C
1200	1-1/2	D

Lantern Battery

- Spring Terminals



PART NUMBER	VOLTS
600	6

Flashlight Bulbs



PART NUMBER	APPLICATION
383	2 D CELL



Swivel Base Lantern

- Battery NOT included
- Uses 383 Bulb

Point It Anywhere!



PART NUMBER	SIZE	BATTERY PART NO.
325	6V	600

Made in U.S.A.

Lantern

- Battery NOT included
- Uses 383 Bulb



PART NUMBER	SIZE	BATTERY PART NO.
326	6V	600

Made in U.S.A.



Industrial Flashlights

- Water resistant
- Non-conduction polypropylene
- Shock proof
- Chemical and grease proof
- Batteries NOT included



PART NUMBER	SIZE	BATTERIES
362	2 CELL	Size D
363	3 CELL	
365	2 CELL	

Made in U.S.A.

Industrial Flashlights

- Economical, yet built to last
- Batteries NOT included



#367



#369 with magnet

PART NUMBER	SIZE	BATTERIES
367	2 CELL	Size D
369		

Made in U.S.A.



Heavy Duty Extension Cords

- Straight caps
- Round cord



PART NUMBER	LENGTH	RATING	CORD TYPE
8024	25'	13-A	16/3 SJT
8025	50'	13-A	
8026	100'	10-A	
8028	50'	15-A	14/3 SJT
8029	100'	13-A	
8037	50'	15-A	12/3 SJT
8038	100'	15-A	

Twist/Lock Type

- Round cord
- Yellow color
- Rated 20 AMP



PART NUMBER	LENGTH	RATING	CORD TYPE
8082	50'	20-A	12/3 ST Yellow

Trouble Lights

- Metal bulb guard
- *Arctic cord



PART NUMBER	LENGTH	RATING	CORD TYPE
8072*	25'	13 A	16/3 SKEW-A BLUE
8073*	50'		
8165	25'	13 A	16/3 SJT
8166	50'		

Disposer, Timer & Furnace Cords

ANGLE CAPS

- Wire Nuts
- Romex Connector
- Ends stripped 5/8"
- Pigtail



PART NUMBER	LENGTH	RATING	CORD TYPE
8121	3'	13-A	16/3 SPT
8122	4'		
8123	5'		
8124	6'		
8125	8'		

STRAIGHT CAPS

- Wire Nuts
- Romex Connector
- Ends stripped 5/8"
- Pigtail



PART NUMBER	LENGTH	RATING	CORD TYPE
8130	3'	13-A	16/3 SPT
8131	4'		
8132	5'		
8133	6'		
8134	8'		



Twin Lead Continuity Tester

- For testing 60-500 V



PART NUMBER
310

Vinyl Electrical Tape

- Multi-Climate
- 3/4" x 60 feet
- 3 mil.



PART NUMBER
1716

Screw-On Wire Connectors

- Industry standard
- Reinforced phenolic
- 600 V



PART NUMBER	DESCRIPTION
5070	Orange = Small Connects wire sizes #22 - #14
5074	Yellow = Medium Connects wire sizes #18 - #10

-10 (for 10 pack) • -100 (for 100 pack)

Bare Copper Grounding Wire

- 6 gauge
- 250 foot spool

New



PART NUMBER
8330

"Romex" Connector

- For garbage disposal pigtails
- Zinc die cast
- Dry location use

New



10 per bag
PART NUMBER
5080

Grounding Adapter

- Bare bronze clamp - steel screws
- Fits 1/2" - 1" pipe
- 2 strand ground wire max

New



10 per bag
PART NUMBER
5075

U-Ground Male Plug

- Meets OSHA requirements
- 15 A Rating



PART NUMBER
8380

U-Ground Female Plug

- Meets OSHA requirements
- 15 A Rating



PART NUMBER
8382

Twist & Lock Male Plug

- Meets OSHA requirements
- 20 A Rating



PART NUMBER
8420

Twist & Lock Female Plug

- Meets OSHA requirements
- 20 A Rating



PART NUMBER
8421



**Adapters
U-Ground 3 Outlet**

- 15 A rating
- 14/3 cord
- All u-ground connection
- 24" length



**PART
NUMBER**
8291

**"Y" Adapter
Twist & Lock Male/Female**

- 15 A rating
- 14/3 cord
- All U-ground connection
- 24" length



**PART
NUMBER**
8306

U-Ground to Twist & Tock

- Female twist and lock to male u-ground
- 15 A plug, 20 A connection
- 12/3 ST cord
- 12" length



**PART
NUMBER**
8299

Twist & Lock to U-Ground

- Male twist and lock to female u-ground
- 15 A plug, 20 A connection
- 12/3 ST cord
- 12" length



**PART
NUMBER**
8302

Twist & Lock to U-Ground

- 3 Outlet
- Female twist and lock to male u-ground
- 15 A plug, 20 A connection
- 12/3 ST cord
- 12" length



**PART
NUMBER**
8304

Thermostat Wire

- Solid copper conductors with PVC insulation, conductors twisted
- Color coded
- Bagged



PART NUMBER	LENGTH	WIRE TYPE
8320	25'	18/2
8321	50'	