

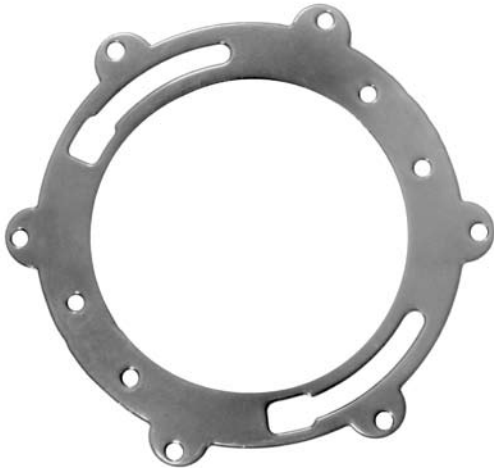

QUICK RING

Replaces ANY Closet Ring!



United States Patent 5,890,239

Unique screw tabs attach to wood or concrete.

Plastisol coat provides corrosion protection.

Slotted for 1/4" or 5/16" closet bolt.

Old closet ring does not need to be present.

Replaces any and all closet rings.

INSTALLATION INSTRUCTIONS

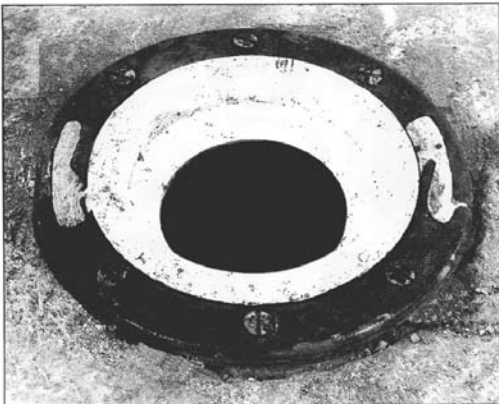

FOR SOLVENT WELDED STEEL/PLASTIC COMBO AND PLASTIC CLOSET RINGS

Remove portion of broken ring, if remaining portion cannot be removed, Quick Ring will mount on top.

Apply a bead of butyl rubber caulk to the underside of the Quick Ring that will mount on top of the old ring.

Set Quick Ring on top of remaining portion of old ring. Note location of old toilet bolt slots. The length of the bolt slots in the Quick Ring allows for some centering of toilet. Secure the Quick Ring to wood or concrete sub floor with screws or anchors.

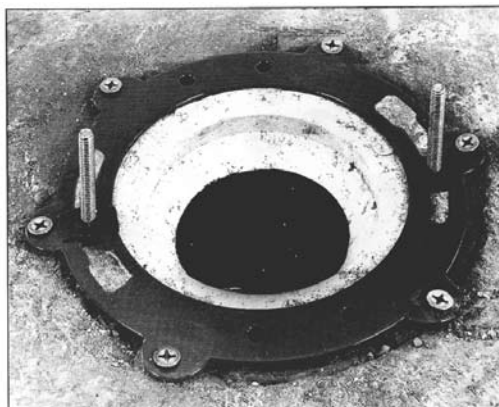

FOR CAST IRON RINGS

The Quick Ring can be mounted directly on top of an old cast iron closet ring. Drill holes in any remaining portion of cast iron ring that corresponds with holes in Quick Ring. Before securing the Quick Ring with screws, apply a bead of butyl rubber caulk to its underside. Large gaps or spaces around or underneath the closet ring, can be filled with any quicksetting type grouts, cements, etc.

PLEASE NOTE:

When setting the toilet use a wax bowl ring with plastic flange.

**PART
NUMBER
21013**

Hose Bibb Anchor

A quick, easy, long lasting solution to stop loose exterior hose bibbs.

- Works with any wall material (brick, concrete, vinyl, or stucco)
- Repair or new home applications
- 5 minute installation that lasts
- Fits 1/2" - 3/4" - 1" water supply lines
- U.S. Patent 5,996,295

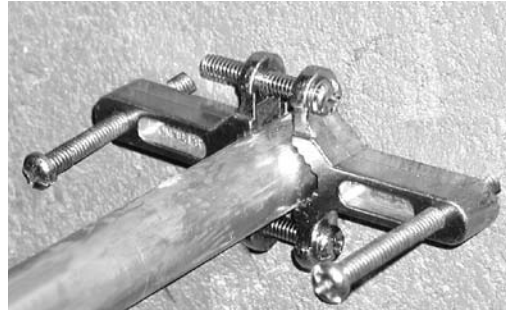
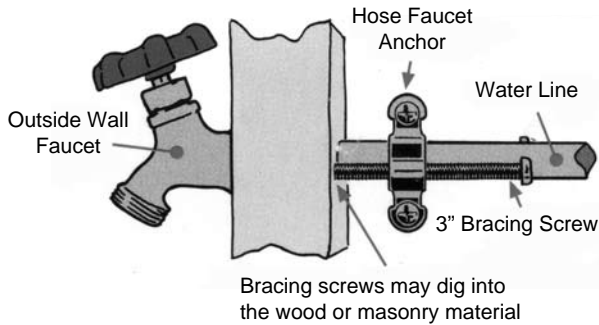

**PART
NUMBER
5023**

Quick Lock Hose Bibb Lock

Prevents unwanted use of most hose bibbs and commercial faucets with hose threads

- Simple, secure, economical
- High quality diecast
- All brass key alike padlock
- Fits hose bibb vacuum breakers
- U.S. Patent 5,182,928



**Sold with
Padlock**

Hose bibb
shown with
vacuum
breaker*

**PART
NUMBER
21540**

Hose Bibb Vacuum Breaker

- Vandal - proof breakoff screw
- ASSE 1011 compliant.
- UPC compliant
- Brass



**PART
NUMBER
2139**



Dishwasher Drain Hose

PASCO Invented Dishwasher Drain Hose!

Our hose is made of braided rubber with a rayon tire grade cord. It is an extremely durable hose and resists kinking.

- Meets AHAM Standard DW-1
- Listed in Table A of the UPC
- 7/8" hose approved for air conditioner condensate drain



SINCE 1966

PART NUMBER	SIZE	LENGTH
50650	5/8"	50'
50750	7/8"	50'

Order by the roll

Reinforced & Standard Garden Hoses



Reinforced:

- 3 Ply - Nylon Vinyl - Braided
- Retains full flexibility down to 0° F.

PART NUMBER	SIZE	LENGTH
531	5/8"	50'
532	5/8"	75'
536	3/4"	50'
555	5/8"	50' 2 ply

Standard:

- Unbraided
- Uniform thickness & strength

PART NUMBER	SIZE	LENGTH
514	1/2"	50'

Dishwasher Air Gap



- White polypro body with chrome plated ABS top
- UPC listed
- * Contains air gap, 7/8" x 24" dishwasher drain hose and 3 clamps

PART NUMBER	SIZE
50710	Air Gap Alone
50712	Air Gap w/Hose*

Kink-Free Garden Hose

- Water flows always
- Heavy duty



PART NUMBER	SIZE	LENGTH
560	5/8"	50'

Dishwasher Connector Kit

- Rigid construction
- Will not collapse



PART NUMBER
496

Hose Clamps



PART NUMBER	SIZE
60010	5/8"
60016	7/8"



Rubber Washing Machine Inlet Hose

- 3/4" female x 3/4" female hose thread
- Braided and reinforced

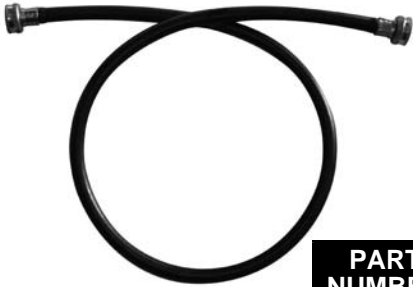

PART NUMBER	LENGTH
464	4"
465	5'
466	6'
468	8'

Made in U.S.A.

Rubber Washing Machine Inlet Hose w/ 90 Degree Elbow

- 3/4" female x 3/4" female hose thread
- Braided and reinforced

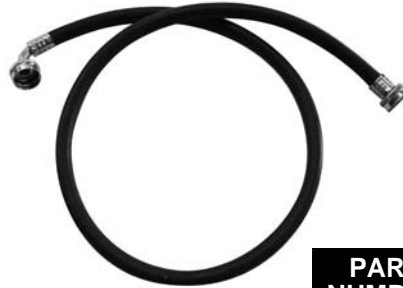

PART NUMBER	LENGTH
474	4"
475	5'
476	6'
478	8'

Made in U.S.A.

Rubber Hook Drain Hose

- Flanged end for multiple sizes
- Fits 3/4" – 7/8" – 1" outlets



PART NUMBER	LENGTH
485	5'
486	6'

Made in U.S.A.

Rubber Utility Hose

- "Y" MIXER HOSE
- 3/4" female hose thread



PART NUMBER
481

Rubber Mop Sink Hose

- 3/4" female hose thread
- 36" braided hose (shortened photo)



Hose and Bracket sold separately

PART NUMBER
489

Made in U.S.A.

Wall Bracket for Mop Sink Hose

- With mounting screws



PART NUMBER
488



Packaged BRASS Bolt Sets with Nuts & Washers

Brass bolts made in the U.S.A.

PASCO has cataloged the most popular bolt sets.

Each set comes with 2 brass bolts, 2 NP brass nuts and 2 plated steel washers.

Please contact us to package any set you require from other componets listed on the following pages.

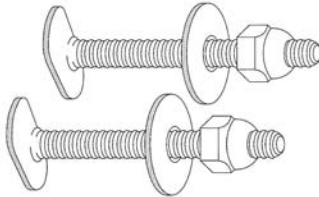

PART NUMBER	SIZE
100	1/4" x 2-1/4"
94	1/4" x 3-1/2"
82	5/16" x 2-1/4"

- With Steel Speed Nuts

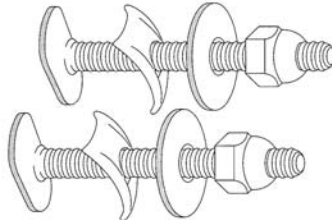

PART NUMBER	SIZE
102	1/4" x 2-1/4"
107	1/4" x 3-1/2"
59	5/16" x 2-1/4"

- With "Push On" Speed Washers

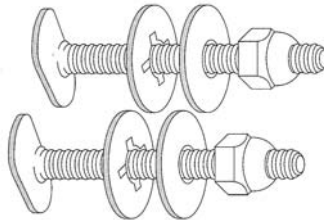

PART NUMBER	SIZE
102-SN	1/4" x 2-1/4"
107-SN	1/4" x 3-1/2"

- With Speed Nuts & Round Plastic Bolt Caps

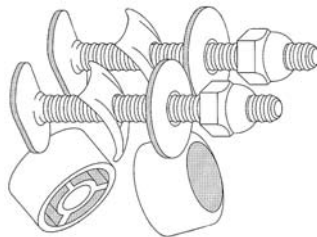

PART NUMBER	SIZE
106	1/4" x 2-1/4"

- With Hex Speed Nuts

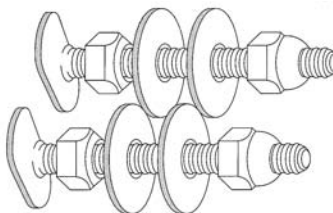

PART NUMBER	SIZE
28	1/4" x 2-1/4"
30	1/4" x 3-1/2"

Packaged ALL STAINLESS STEEL Bolt Sets with Stainless Steel Nuts & Washers

Marine grade 305 stainless steel - packaged one pair per bag
Easily cut with Tiny Tim Hacksaw

Won't Corrode

PART NUMBER	SIZE
100-SS	1/4" x 2-1/4"
94-SS	1/4" x 3-1/2"

- With Tinnerman Nuts

PART NUMBER	SIZE
102-SS	1/4" x 2-1/4"
107-SS	1/4" x 3-1/2"

- With Plastic Speed Washers

PART NUMBER	SIZE
102-SSN	1/4" x 2-1/4"
107-SSN	1/4" x 3-1/2"

- With Tinnerman Nuts & Round Plastic Bolt Caps

PART NUMBER	SIZE
106-SS	1/4" x 2-1/4"

- "DOUBLE NUT"
With Hex Speed Nuts

PART NUMBER	SIZE
28-SS	1/4" x 2-1/4"
30-SS	1/4" x 3-1/2"

Bulk Stainless Steel Bolts, Nuts & Washers - 100 Pack

Bolts Only	
PART NUMBER	SIZE
104-SS	1/4" x 2-1/4"
111-SS	1/4" x 3-1/2"

Nuts Only	
PART NUMBER	SIZE
1647-SS	1/4"

Washers Only
PART NUMBER
140



Closet Bolts, Screws, Nuts & Washers

100 Bulk packed

Closet Studs

• Brass



PART NUMBER	SIZE
108	1/4" x 2-1/4"

Made in U.S.A.

Closet Screws

• Brass

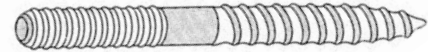

PART NUMBER	SIZE
120	1/4" x 2-1/4"
121	1/4" x 3-1/2"

Made in U.S.A.

Closet Bolts

• Brass

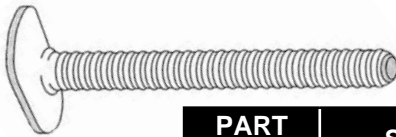

PART NUMBER	SIZE
110	1/4" x 2-1/4"
111	1/4" x 3-1/4"
112	5/16" x 2-1/4"
113	5/16" x 3-1/2"

Made in U.S.A.

Closet Bolt Washers

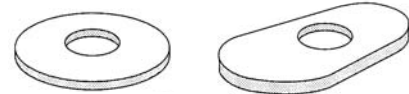

Round Washer

Oval Washer

PART NUMBER	MATERIAL	HOLE SIZE	PART NUMBER
138	Plated Steel - Round	5/16"	—
140	Heavy Stainless Steel	5/16"	147
142	Heavy NP Brass	5/16"	149

Plastic Bolt Caps

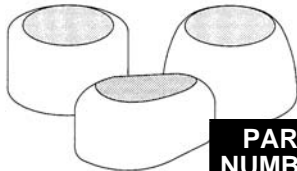

PART NUMBER	SIZE	SHAPE
912	1/4"	Oval
913	1/4"	Round
917-PR*	1/4" or 5/16"	Round

* With snap on washer

Speed Nuts



PART NUMBER	SIZE	MATERIAL
136	1/4"	Steel
136-P	1/4"	Plastic
143	5/16"	Steel

Open Head Bolt Nuts

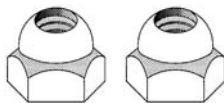

PART NUMBER	SIZE	MATERIAL
132	1/4"	Plated Brass
133	5/16"	Plated Brass
1647-SS	1/4"	Hex Stainless Steel

Closed Head Screw Nuts

• Plated Brass

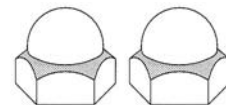

PART NUMBER	SIZE
134	1/4"



Closet Bolts, Screws, Nuts & Washers

100 Bulk packed

Combo Brass Closet Screws, Nuts & Washers

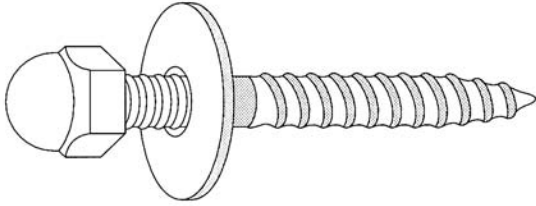

PART NUMBER	SIZE	ROUND WASHER
152	1/4" x 2-1/2"	Plated Steel
153	1/4" x 3-1/2"	
156	1/4" x 2-1/2"	Stainless Steel
157	1/4" x 3-1/2"	
162	1/4" x 2-1/2"	Plated Brass
163	1/4" x 3-1/2"	

Combo Brass Closet Bolts, Nuts & Washers

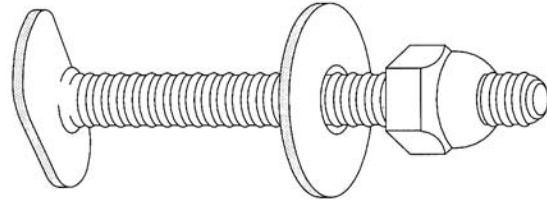

* Breakoff Bolts

PART NUMBER	SIZE	ROUND WASHER
180	1/4" x 2-1/4"	Plated Steel
181	1/4" x 3-1/2"	
184	1/4" x 2-1/4"	Stainless Steel
185	1/4" x 3-1/4"	
188	1/4" x 2-1/4"	Plated Brass
189	1/4" x 3-1/4"	

Combo Brass Closet Bolts Nuts & Washers

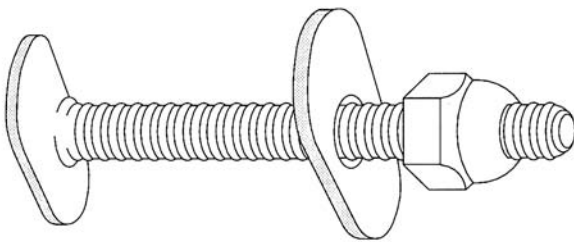

PART NUMBER	SIZE	ROUND WASHER
192	1/4" x 2-1/4"	Plated Steel
193	1/4" x 3-1/2"	
196	1/4" x 2-1/4"	
197	5/16" x 3-1/2"	Stainless Steel

Plastic Toilet Shims

"Takes the Wobble Out"
• Hard or Soft

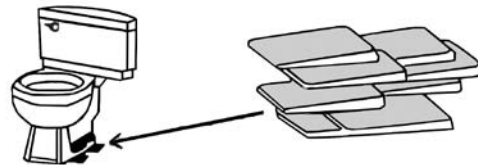

PART NUMBER	TYPE	QUANTITY
234	Hard	10
2346	Hard	300
2347	Soft	300

Made in U.S.A.



Closet Bowl Wax Gasket

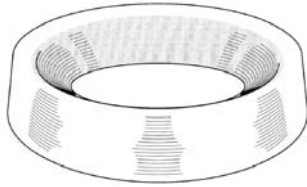

PART NUMBER	DESCRIPTION
268	Gasket
269	Gasket w/ #102 brass bolt sets

Made in U.S.A.

Closet Flange Extension

- 1/4" thick
- Durable ABS

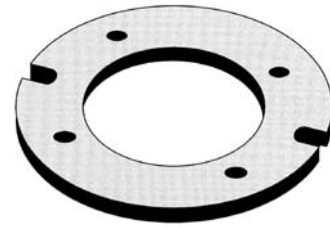

PART NUMBER
1018

Made in U.S.A.

Flex-A-Flange

Closet Bowl Wax Gasket With Plastic Flange

- For 3" or 4" cast iron, brass, plastic and steel/plastic combo closet rings.

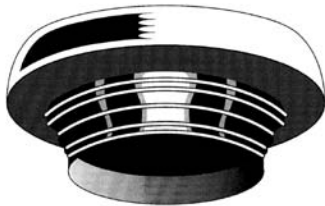

PART NUMBER	DESCRIPTION
270	Flange
271	Flange w/#102 brass bolt sets

Made in U.S.A.

Closet Flange Extension Kit

Kit Contains:

- 3 Self-sealing extenders
- With 1/4" x 3-1/2" closet bolts, nuts & washers

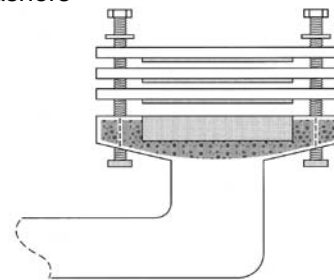

PART NUMBER	BOLT SET
1018-K	Stainless Steel
1018-BR	Brass

Sponge Rubber Closet Bowl Gasket

- Resists mold, mildew and fungus



PART NUMBER	THICKNESS & DIAMETER
2228	9/16" x 5-1/4"
2230	3/4" x 5-1/4"

Made in U.S.A.

Sponge Rubber Closet Bowl Gasket

Covers Entire Width of Closet Ring

- Resists mold, mildew and fungus
- Has holes for closet bolts



PART NUMBER	THICKNESS & DIAMETER
2227	3/8" x 6-3/4"
2231	3/4" x 6-3/4"

Made in U.S.A.

Brass Tank to Bowl Bolt Sets

Each Set Contains:

- Brass Bolts
- Brass Hex Nuts
- Cloth Inserted Rubber Washers
- Plated Brass Washers



Made in U.S.A.

PART NUMBER	SIZE	WASHERS	
		RUBBER	PLATED BRASS
235	5/16" x 3"	2	2
237	5/16" x 3"	4	4

Stainless Steel Tank to Bowl Bolt Sets

Each Set Contains:

- 2 Stainless Steel Bolts
- 4 Stainless Steel Hex Nuts
- 4 Cloth Inserted Rubber Washers
- 4 Stainless Steel Washers



Made in U.S.A.

Won't Corrode



PART NUMBER	SIZE
237-SS	5/16" x 3"

Tank to Bowl Connector Kit with Rubber Components

With Rubber Gasket

Each Set Contains:

- 1 Rubber Gasket
- 2 Bolts: Brass or Stainless Steel
- 4 Heavy Washers: Brass or Stainless Steel
- 4 Rubber Washers
- 4 Hex Nuts: Brass or Stainless Steel



Made in U.S.A.

PART NUMBER	GASKET TYPE	MATERIAL
437	Regular	Brass
437-SS	Regular	Stainless Steel
439	AmStan	Brass
439-SS	AmStan	Stainless Steel

Cloth Inserted Rubber Washers

- For Tank to Bowl Bolt



Made in U.S.A.

PART NUMBER
242

Hex Nut - Brass - Stainless Steel

- For Tank to Bowl Bolt



PART NUMBER	SIZE	MATERIAL
243-B	5/16"	Brass
243-SS	5/16"	Stainless Steel

Tank to Bowl Bolts - Brass - Stainless Steel



Made in U.S.A.

PART NUMBER	SIZE	MATERIAL
232	5/16" x 3"	Brass
232-SS	5/16" x 3"	Stainless Steel



Toilet Tank Trip Levers

Premium Quality

- 8" Flat brass arm
- CP Die cast handle
- Die Cast lock nut



**PART
NUMBER**
1055

Economy

- 8" ABS Plastic arm
- CP ABS Plastic handle



**PART
NUMBER**
1047

Economy

- 8" Round brass arm
- CP Die cast handle
- Die cast spud
- **NEW** finger tight locknut



**PART
NUMBER**
1040

Economy

- 8" Round brass arm
- CP Die cast handle
- Plastic spud
- **NEW** finger tight locknut



**PART
NUMBER**
1041

Economy

- 4" ABS Plastic arm
- CP ABS handle
- Replaces American Standard #3521-136



**PART
NUMBER**
1046

Toilet Tank Trip Levers

Index Style

- 8" Round brass arm
- CP Die cast handle
- Plastic spud
- Plastic lock nut



**PART
NUMBER**
1057

Mansfield

- 9" White plastic arm
- CP Die cast handle
- Plastic spud
- Plastic lock nut



**PART
NUMBER**
1045

Western Pottery & Toto

- 10" Round brass arm
- CP Die cast handle
- Plastic spud
- Plastic locknut
- Side mount



**PART
NUMBER**
1058
1059

Kohler Wellworth II

- 8" Plastic arm
- CP Die cast handle
- Plastic spud
- Plastic locknut



**PART
NUMBER**
1053

Eljer

- 10" Brass arm
- CP Die cast handle
- Plastic spud
- Plastic locknut
- Side mount



**PART
NUMBER**
1054

Offset - Premium Quality

- 9-1/2" Offset flat brass arm
- CP Die cast handle
- Modern styling
- High Quality
- Die cast locknut



**PART
NUMBER**
1056



korky[®]

- Universal replacement flapper
- Preferred by plumbers for superior quality and reliability since 1954.



PART NUMBER
54

korkyplus[®]

- Premium quality Chlorazone material withstands chloramine and toilet tank cleaners
- 5-Year guarantee
- Universal replacement flapper



PART NUMBER
2001

korky1.6[®]

- Fits most 1.6 gallon toilets
- The adjustable water-saver saves up to 50% more water when used in conventional toilets.



PART NUMBER
16

korky[®]

NEW

- Fits Kohler[®] Rialto™/Float**
- Replaces Kohler p/n 83064
 - Embedded styrofoam float
 - Fits specific Kohler one-piece toilets
 - Premium red Chlorazone[®] rubber resists chlorine



PART NUMBER
2010

korky[®]

NEW

- Fits Kohler[®] Hinge**
- Replaces Kohler p/ns 84995 & 1000490
 - Flapper hinges onto back of flush valve
 - Fits specific Kohler one-piece toilets
 - Premium red Chlorazone[®] rubber resists chlorine



PART NUMBER
2011

korky[®]

NEW

- Fits Kohler[®] Shark Fin**
- Replaces Kohler p/ns 84318, 84314, 85655 and 89825
 - Premium red Chlorazone[®] rubber resists chlorine



PART NUMBER
2012



With Styrofoam float

- This flapper includes the styrofoam float and is adjustable for the perfect flush



PART NUMBER
2004



Fits TOTO® G-Max™ Flapper

- Authorized replacement flapper for TOTO G-Max toilets
- 3" sealing surface for larger TOTO flush valve seats
- Premium red Chlorazone® rubber resists chlorine



PART NUMBER
2021



Fits TOTO® Power Gravity™ Flapper

- Authorized replacement flapper for TOTO Power Gravity toilets
- 3" sealing surface for larger TOTO flush valve seats
- Premium red Chlorazone® rubber resists chlorine



PART NUMBER
2022K



Fits Kohler® Class Five Flapper

- Larger 3-1/4 replacement flapper
- Replaces Kohler p/ns 1016546 & 1042313
- Engineered materials resist chlorine
- Five year guarantee



PART NUMBER
3010K



Fits American Standard® Champion® Flush Valve Seal

- Replaces AmStan p/n 738651-0070A
- Engineered materials resist chlorine

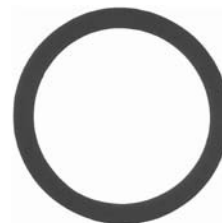

PART NUMBER
428



Rubber Flapper

Stainless Steel Chain

- High quality rubber
- Resistant in tank bowl cleaners



PART NUMBER
1026

3 Way Flapper

Stainless Steel Chain

- High quality vinyl



PART NUMBER
1028-S

Plastic Flush Valve Flapper

Stainless Steel Chain

- High quality vinyl



PART NUMBER
1033

Rubber Flapper

8" Chain

- For Kohler
- Resistant to tank bowl cleaners



PART NUMBER
1031

American Standard Flapper

With Float



PART NUMBER	REPLACES AMSTAN #	DESCRIPTION
1038	#5	Low Profile
1039	#6	High Profile
1042	Repair kit with chain rubber grommet & clip	

Disk Seat Flapper

For American Standard



PART NUMBER	DESCRIPTION
1035	Combo Fit-All
1036	Screw-On
1037	Snap-On

Douglas Flush Valve

- Rubber washer
- Solid ring guide
- Locknut
- Overflow tube



PART NUMBER	DESCRIPTION
1027	Brass Locknut
1029	White Plastic Flush Valve, with Flapper

Lift Wires - Brass

- Order in packs of 25 or 100



PART NUMBER	DESCRIPTION
851	5-1/2" Lower lift wire
856	9" Upper lift wire

Made in U.S.A.

Brass Overflow Tubes



Made in U.S.A.

PART NUMBER	DIAMETER	LENGTH
870	1"	10"
873	1" x 1-1/8"	10"

Brass Float Rods

1/4" - 20 Threads



Made in U.S.A.

PART NUMBER	LENGTH
882	8"
883	9"
884	10"
886	12"

Tank Ball

- Resists chlorinated water
- Never swells
- One ball for all sizes
- High quality rubber



PART NUMBER
1032

Tank Floats

- Copper or Plastic
- 1/4" Float Rod



PART NUMBER	SIZE	TYPE
1060-12	4" x 5"	Oval Copper
1073	4" x 5"	Oval Plastic

Made in U.S.A.



Brass Urinal Outlet Spud

IPS or Sweat Connection

- With studs, washers and nuts and #2096 sponge type gasket



PART NUMBER	DRAIN CONNECTION	URINAL TYPE	BOLT HOLE CENTERS
94700	2" IPS	Crane	5-1/2"
94701	2" Sweat	Crane	5-1/2"
94702	2" IPS	Crane Hex Bolts	5-1/2"
94703	2" IPS	UR	4-1/2"
94704	2" IPS	Elijer	4-1/4"
94705	2" Sweat	Elijer	4-1/4"
94706	2" IPS	AmStan	4"

Closet & Urinal Spuds



PART NUMBER	TYPE	SIZE	LOCKNUT
956	Closet	2"	Brass
956A	Closet	2"	Diecast
957	Closet	2" x 1-1/2"	Brass
958	Closet	2" x 1-1/4"	Brass
959	Closet	1-1/2"	Brass
960	Closet	1-1/4"	Brass
961	Urinal	1" x 3/4"	Brass
962	Urinal	1-1/4" x 3/4"	Brass
963	Closet	1-1/2" x 1-1/4"	Brass

Anti-Siphon Ballcocks

- Reliable - Quiet
- Brass float rod
- Adjustment screw



PART NUMBER	DESCRIPTION
1009	8-1/2"
1010	10"
1011	12"
1015-N	Diaphragm & Adjustable Screw
1320	Plastic Coupling Nut
2099	Shank Washer

Lock Nuts



PART NUMBER	SIZE	MATERIAL
1294	1/2"	Die Cast
1295	3/4"	Die Cast
1301	1-1/2"	Die Cast
1303	2"	Die Cast
1306	1-1/4"	Brass
1307	1-1/2"	Brass
1312	3-3/8"	Brass Basket Strainer
1316	3-3/8"	Die Cast Basket Strainer

Lavatory Coupling Nuts



PART NUMBER	SIZE	MATERIAL
1322	1/2" x 7/16"	Brass
1326-C	1/2" x 3/8"	CP Die Cast
1328-C	1/2" x 1/2"	CP Die Cast
1329-C	3/4" x 1/2"	CP Die Cast Bathcock
1335	1/2" x 1/2"	Brass
1335-C	1/2" x 1/2"	CP Brass

Ballcock Coupling Nut



PART NUMBER	MATERIAL
1320	Plastic
1321	Brass

Brass Friction Rings



PART NUMBER	SIZE
1385	1/2" x 3/8"
1389	1/2" x 1/2"
1391	1-1/4"
1392	1-1/2" x 1-1/4"
1394	1-1/2"
1397	3/4" x 3/8"



Die Cast Slip Joint Nuts



PART NUMBER	SIZE	FINISH
1324-C	2" x 1-1/2"	Chrome
1330-C	1-1/4"	Chrome
1331-C	1-1/2" x 1-1/4"	Chrome
1332-C	1-1/2" x 1-3/8"	Chrome
1333-C	1-1/2"	Chrome
1333-P	1-1/2"	Plain
1334-C	2"	Chrome

Brass Slip Joint Nuts



PART NUMBER	SIZE	FINISH
1336	1-1/4"	Rough
1336-C	1-1/4"	Chrome
1337	1-1/2" x 1-1/4"	Rough
1337-C	1-1/2" x 1-1/4"	Chrome
1338	1-1/2"	Rough
1338-C	1-1/2"	Chrome
1339	2"	Rough
1339-C	2"	Chrome

Chrome Slip Joint Nut Sets with Washer, Friction Ring



PART NUMBER	SIZE	MATERIAL
1346-C	1-1/4"	Brass
1347-C	1-1/2" x 1-1/4"	Brass
1348-C	1-1/2"	Brass
1349-C	1-1/4"	Die Cast
1350-C	1-1/2" x 1-1/4"	Die Cast
1351-C	1-1/2"	Die Cast

Plastic Slip Joint Nuts

PVC
• One Piece



PART NUMBER	SIZE
1352	1-1/4"
1353	1-1/2"

Brass Solder Collars

• Threads fit slip joint nuts



PART NUMBER	SLIP JOINT	FOR USE WITH
1314	1-1/2"	Tubular
1315		CWT



Tank-to-Bowl Gaskets

- Sponge Rubber



PART NUMBER	DESCRIPTION
2096	Regular
2097	Recessed for AmStan
2098	Gerber

Slip Joint Washers

- Square Cut Washers



PART NUMBER	SIZE
2201	2" x 1-1/2"
2202	2"
2204	1-1/2"
2208	1-1/2" x 1-1/4"
2209	1-1/4"

Poly Washers for Tailpieces



PART NUMBER	SIZE	DESCRIPTION
2214	1-1/2"	Beveled
2218	1-1/2" x 1-1/4"	Beveled
2219	1-1/4"	Beveled
2222	1-1/2"	Flanged

Tailpiece Washer

- Cloth Inserted Rubber
- Top quality, excellent seal



PART NUMBER	SIZE
2211	1-1/2" x 1-1/4"

Ballcock Shank Washer

- Beveled Rubber

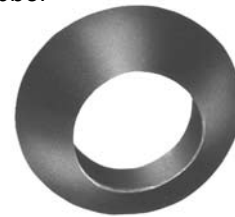

PART NUMBER
2099

Garden Hose Washer

- Fits 3/4" FHT



PART NUMBER
2224

Cone Filter Washer

- Fits 3/4" FHT



PART NUMBER
2244



1-1/4" Mack Washer

- For Pop-Ups
- Rubber



PART NUMBER
2074

Wall Hung Urinal Spud Washer

- Large style for additional sealing surface
- 4-3/8" OD x 2-7/8" ID
- 1/2" Thick
- Sponge Rubber



PART NUMBER
2083

Spud Friction Rings

Galvanized

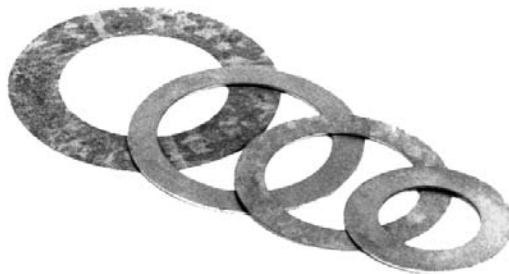

PART NUMBER	SIZE
2075	2"
2078	1-1/2"
2079	1-1/4"
2080	1" x 3/4"

Spud Washers

- Rubber



PART NUMBER	SIZE
2085	2"
2086	2" x 1-1/2"
2088	1-1/2"
2089	1-1/4"
2090	1" x 3/4"

Waste & Overflow Washers

- Sponge Rubber



PART NUMBER	DESCRIPTION
2091	2-1/8" x 3" x Beveled
2092	1-7/8" x 2-7/8" x 3/8"

Douglas Flush Valve Washer

- Sponge Rubber
- Fits urinal outlet spuds



PART NUMBER
2093



Garbage Disposal Shield



PART NUMBER
1358

O-Ring Pick



PART NUMBER
5200

Plumbers Pack O-Ring Kit

Popular O-ring sizes in a reusable box



PART NUMBER
2250

Made in U.S.A.

Faucet Stem Washer Assortment - Flat

- 00-1/2" Trade Size
- 350 Pieces
- 8 common sizes fit most stems manufactured

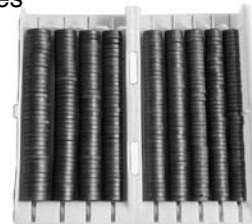

PART NUMBER
2870

Made in U.S.A.

Cone Slip Joint Washers



2276 2277 2277-A 2285 2286 2287

PART NUMBER	SIZE		USAGE
	I.D.	H.T.	
2276	3/8"	3/8"	1/2" Nut
2277	3/8"	3/8"	3/8" Tube
2277-A	7/16"	7/16"	1/2" Nut 7/16" or 1/2" Tube

Soap Dispenser



THROUGH THE COUNTER

- 2" Spout 10" Length
- Chrome plated brass pump
- Mounts through counter
- Unbreakable poly bottle
- Holds 7 oz.

PART NUMBER	DESCRIPTION
2042	Complete Dispenser
2042-B	Bottle Only
2042-N	Brass Nipple with Nut & Friction Ring Washer

Candle Wicking

- Seals bonnet nuts
- Lubricates stems
- Random length



PART NUMBER
2872

Graphite Packing

- 3/32" x 24" Length



PART NUMBER
2290



Commercial Grid Style Lavatory Drain

Highest Quality

- #1175 & 1179 Chrome plated brass body
- #1176 Stainless steel body
- 1-1/4" Stainless steel tailpiece
- Brass locknut
- Rubber gasket with overflow



PART NUMBER	TAILPIECE LENGTH
1175	4"
1176*	6"
1179	12"

Individually Boxed
* Most Popular

Handicap Commercial Grid Style Lavatory Drain

Highest Quality

- Chrome plated brass body
- 1-1/4" stainless steel tailpiece
- Rubber gasket with overflow



PART NUMBER	DESCRIPTION
1177-TP	With Tailpiece

Individually Boxed

Handicap Style Lavatory Drain

Less Waste Elbow Highest Quality

- Chrome plated brass body
- Threaded 1-1/4" for waste elbow
- Brass locknut
- Rubber gasket



PART NUMBER
1177

Individually Boxed

Rubber Stopper Lav Drain

- 20 GA CP brass
- 1-1/4" x 6" tailpiece
- Rubber stopper with chain



PART NUMBER
1178

Individually Boxed

Brass Waste Connectors (Desanko Fittings)

The charts below let you choose the type of slip joint nut, either chrome plated die cast or plain brass and the type of compression ring, either brass or poly. To order waste connectors with chrome plated brass nuts, add CP to waste connector part number.

Tubular X Male Pipe Thread (Outlet) Female Copper Sweat Under MPT



PART NUMBER	TUBULAR X MPT	SLIP NUT	COMPRESSION RING
1893	1-1/4" x 1-1/2"	Chrome Die Cast	Brass
1894	1-1/2"		
1943	1-1/4" x 1-1/2"	Rough Brass	
1944	1-1/2"		
1905	1-1/4" x 1-1/2"	Chrome Die Cast	Poly
1906	1-1/2"		
1944-S w/stops*	1-1/2"	Rough Brass	Brass

*Complies with UPC

Tubular X Female Pipe Thread (Outlet)



PART NUMBER	TUBULAR X FPT	SLIP NUT	COMPRESSION RING
1895	1-1/4"	Chrome Die Cast	Brass
1896	1-1/4" x 1-1/2"		
1897	1-1/2"		
1946	1-1/4" x 1-1/2"	Rough Brass	Poly
1947	1-1/2"		
1908	1-1/4" x 1-1/2"	Chrome Die Cast	
1909	1-1/2"		
1947-S w/stops*	1-1/2"	Rough Brass	Brass

*Complies with UPC

Female Copper Sweat (Outlet)



PART NUMBER	TUBULAR X COPPER	SLIP NUT	COMPRESSION RING
1899	1-1/4" x 1-1/2"	Chrome Die Cast	Brass
1900	1-1/2"		
1949	1-1/4" x 1-1/2"	Rough Brass	
1950	1-1/2"		
1911	1-1/4" x 1-1/2"	Chrome Die Cast	Poly
1912	1-1/2"		

Continued on following page



Brass Waste Connectors (Desanko Fittings)

The charts below let you choose the type of slip joint nut, either chrome plated die cast or plain brass and the type of compression ring, either brass or poly. To order waste connectors with chrome plated brass nuts, add CP to waste connector part number.

Male Copper Sweat (Outlet)



PART NUMBER	TUBULAR X COPPER	SLIP NUT	COMPRESSION RING
1901	1-1/4"	Chrome Die Cast	Brass
1903	1-1/2"		
1953	1-1/2"	Rough Brass	Poly
1915	1-1/2"	Poly	

Chrome Plated Brass Cover Tube for Copper or CPVC

- Slips over either copper or CPVC supply lines between the wall and angle stop.
- Fits over 5/8" OD Tube
- 3-1/2" Length

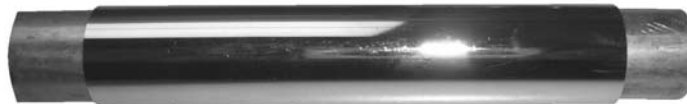

PART NUMBER
8489

Chrome Plated Copper Supply Tubing

- "Spaghetti"
- 3/8" x 6 Foot - soft
- 50 Per case



PART NUMBER
17990

Brass Tubular Compression Rings



PART NUMBER	SIZE
1990	1-1/4"
1992	1-1/2"

Aerators

Quality recognized for years throughout the industry!

Premium Quality Aerators

- Chrome plated brass
- Special stainless steel screen
- Stylized appearance
- NSF listed Santoprene® washer
- All aerators are individually bagged
- Meets ANSI A-112.18M
- 2.2 GPM at 60 PSI
- 2.5 GPM at 80 PSI



SLOTTED

PART NUMBER	THREADS
2103	Female 55/64" - 27
2105	Dual 15/16 - 55/64" - 27

NON-SLOTTED - POLISHED BRASS

2105PB	Dual 15/16 - 55/64" - 27
--------	--------------------------

SLOTTED WATER SAVER

2104	Dual 15/16 - 55/64" - 27
------	--------------------------

Economy Quality Aerators

- Chrome plated brass
- Stylized appearance
- NSF listed Santoprene® washer
- All aerators are individually bagged
- Meets ANSI A-112.18M
- 2.2 GPM at 60 PSI
- 2.5 GPM at 80 PSI



SLOTTED

PART NUMBER	THREADS
2124	Dual 15/16 - 55/64" - 27
2130	Male 15/16" - 27
2131	Female 55/64" - 27

NON-SLOTTED WATER SAVER

2132	Male 15/16" - 27
2134	Dual 15/16 - 55/64" - 27

Aerator Counter Displays

These displays are guaranteed to trigger an impulse purchase by the plumber!

Small display generates BIG profits!

24 tubes - 6 aerators per tube



SLOTTED PREMIUM QUALITY

PART NUMBER	THREADS
2106	Contains 144-2105
2107	Contains 144-2104 Water Saver

NON-SLOTTED ECONOMY QUALITY

2125	Contains 144-2124
2136	Contains 144-2134 Water Saver



Kitchen Sink Hose & Spray Head

- Replaces existing units

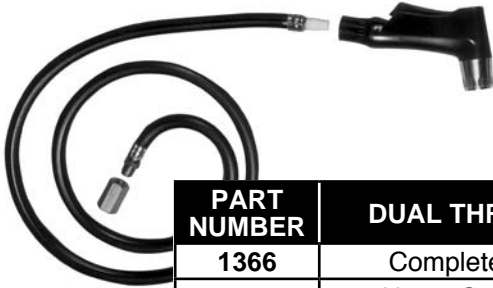

PART NUMBER	DUAL THREADS
1366	Complete Unit
1367	Hose, Coupling
1367-W	White Complete Unit
1368	Head ONLY
1368-W	White-Head ONLY

Fit All Kitchen Basket Strainer

- Stainless steel
- Fits most styles of kitchen basket strainers
- CP brass lift post
- Rubber stopper



PART NUMBER
21926

Junior Basket Strainer

For 2" - 2-1/2" Outlet

- CP Brass body
- Stainless steel basket
- Complete with washers & nuts



PART NUMBER	LOCKNUT	SLIP JOINT NUT
1361	Die Cast	Plated Die Cast
1361-BN	Brass	Brass
1361-B	Basket Only	

Junior Duo Strainer

For 2" - 2-1/2" Outlet

- CP Brass body
- Stainless steel basket
- Complete with washers & nuts



PART NUMBER	LOCKNUT	SLIP JOINT NUT
1365	Die Cast	Plated Die Cast
1365-BN	Brass	Brass
1365-B	Basket Only	

Tray Plug

For 2" - 2-1/2" Outlet

- CP Brass body
- Rubber Plug
- Complete with washers & nuts



PART NUMBER	LOCKNUT	SLIP JOINT NUT
1370	Die Cast	Plated Die Cast
1370-BN	Brass	Brass

Flat Duplex Strainer

For 2" - 2-1/2" Outlet

- CP Brass body
- Stainless steel strainer
- Complete with washers & nuts



PART NUMBER	LOCKNUT	SLIP JOINT NUT
1371	Die Cast	Plated Die Cast
1371-BN	Brass	Brass



EZ ON Basket Strainer

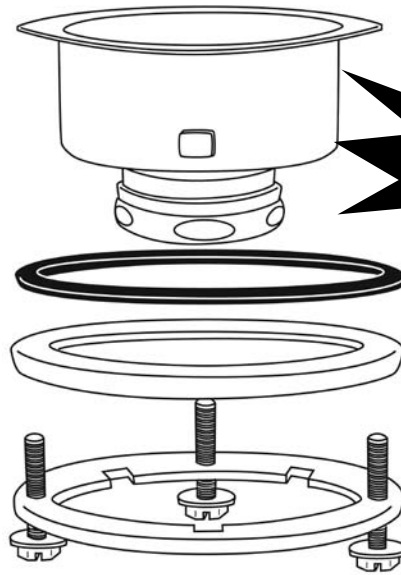

**Installs in
less than
30 seconds!**

EZ ON Satin Stainless Steel Finish

- 304 stainless steel body
- Polished drain flange
- Stainless steel basket
- Fits sink openings of 3 1/2" to 4"



**PART
NUMBER**
21901

EZ ON - Bright Polished Stainless Steel Finish

- 304 stainless steel body
- All surfaces polished
- Stainless steel basket
- Fits sink openings of 3 1/2" to 4"



**PART
NUMBER**
21907

EZ ON Brushed Nickel Finish

- All surfaces are PVD finish
- Finish will not chip or corrode
- Basket finished to match
- Fits sink openings of 3 1/2" to 4"



**PART
NUMBER**
21905



Specification Grade Stainless Steel Basket Strainer - 2 Styles

- Heavy duty - cup style
- 3-1/2" to 4" Sink drain opening
- 304 Stainless steel bodies
- Stainless steel basket
- Die cast locknut and slip joint nut
- Poly tailpiece washer
- #21915 Specification basket strainer has brass locknut and slip joint nut



Equal to:
 Watts 644003
 Dearborn 14
 *Watts 652003

PART NUMBER	DESCRIPTION
21914	Complete Unit
21922	Basket Only
21924	Basket Only

Spin Lock Chrome Plated Brass Basket Strainer

- 3-1/2" to 4" sink drain openings
- Stainless steel screw in basket
- Brass locknut and slip joint nut
- Poly tailpiece washer



Equal to:
 Dearborn 17
 Watts 653003

PART NUMBER	DESCRIPTION
21917	Complete Unit
21923	Basket Only

Plumber Quality Chrome Plated Brass Basket Strainer

- 3-1/2" to 4" sink drain openings
- Stainless steel stick post basket
- Die cast slip joint nut and locknut
- Poly tailpiece washer



Equal to:
 Dearborn 16
 Watts 2-8-3
 Sanitary Dash SS250
 Garvin 2250

PART NUMBER	DESCRIPTION
21906	Complete Unit



Lavatory Legs

Adjustable To Fit a Variety of China and Enamel Lavatories

- Chrome plated
- 2" Adjustment
- 30" overall length
- Boxed by the pair
- Installation instructions with each pair

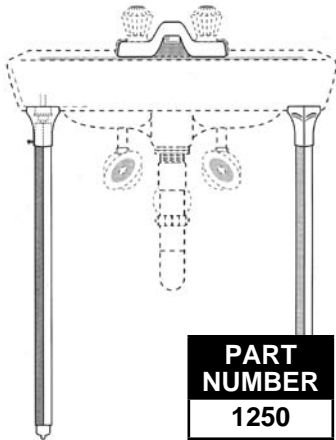

PART NUMBER
1250

Brass Pop-Up Assemblies

Highest Quality

- Chrome plated brass
- Brass locknut

*plastic

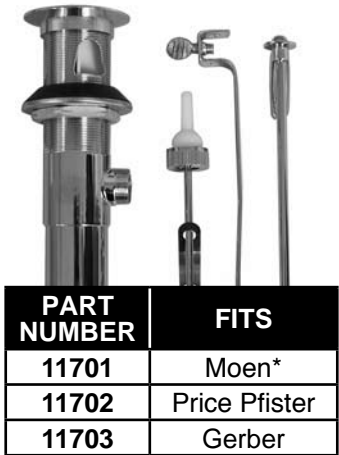

PART NUMBER	FITS
11701	Moen*
11702	Price Pfister
11703	Gerber

Crumb Cup Strainer

- Chrome plated brass
- #1341 - 1-7/8" x 1"
- #1344 - 1-1/4" x 11/16"



PART NUMBER	FITS
1341	Sink
1344	Lavatory less post

Replacement Strainers

Snap-in stainless steel



PART NUMBER	STRAINER SIZE	FITS
1205	3"	2" DWV
1206	4"	3" DWV
1207	5"	4" DWV

Deep Basin Rosette

- Stamped steel



PART NUMBER
1266

Flat Basin Rosette

- Stamped steel



PART NUMBER
1268

Faucet Hole Covers



PART NUMBER	SIZE
1274	2"
1275	1-3/4"

Snap-In Faucet Hole Cover

- Chrome plated
- Fits 1-1/2" hole



Holes in china or stainless steel fixtures vary in diameter. This cover fits most but not all manufacturers

PART NUMBER
1279

Made in U.S.A.



Lavatory Hanger

For Iron Lavatories

- Cast iron
- 10-1/2" Wide
- Extra heavy cast iron

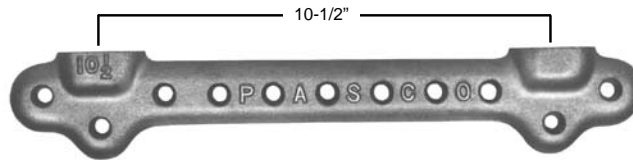

PART NUMBER
1219

Lavatory Hanger

For China Lavatories

- Stamped steel
- Supplied in pairs



PART NUMBER
1220

Made in U.S.A.

"Z" Hanger

Adjustable For Enameled Iron or China Lavatories

- For iron, side lugs fit the pockets
- For china, knock off the side lugs
- 5" to 16" adjustment
- Cast iron



PART NUMBER
1221

Lavatory Hanger

For China Lavatories

- Stamped steel
- Plated for corrosion resistance
- 8" wide

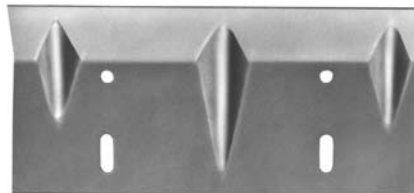

PART NUMBER
1222

Made in U.S.A.

Amstan Style Lavatory Hanger

Designed to fit Amstan Style Lavatories

- Stamped steel
- Plated for corrosion resistance
- 10-1/2" wide

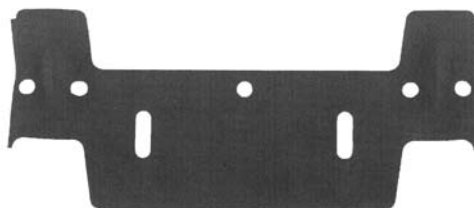

PART NUMBER
1223

Made in U.S.A.

Tub Spouts

- Chrome plated brass or die cast
- 5-5/8" Length



PART NUMBER	MATERIAL	FINISH	MOUNT	FPT
1115	Brass	Chrome	Front	1/2"
1126	Brass	Chrome	Back	1/2" - 3/4"
1134	Die Cast	Chrome	Front	1/2"

Diverter Spouts, Front Lift

- Chrome plated brass or die cast
- 5-5/8" Length
- Front mount



PART NUMBER	MATERIAL	FINISH	FPT
1117	Brass	Chrome	1/2"
1128	Die Cast	Chrome	1/2"

Adjustable Tub and Diverter Spouts

- Copper or IPS**
- Chrome plated die cast
 - 5-5/8" Length



PART NUMBER	FINISH	ADJUST.	DIVERTER	PIPE SIZE
1136	Chrome	2-1/4"	No	1/2" CWT
1142	Chrome	2-1/4"	Yes	1/2" CWT
1143	Chrome	1"	No	1/2" - 3/4" IPS
1144	Chrome	1"	Yes	1/2" - 3/4" IPS



Diverter Spouts, Back Lift

- Chrome plated brass or die cast
- 5-5/8" Length
- Back mount



PART NUMBER	MATERIAL	FPT
1127	Brass	1/2"
1129	Brass	3/4"
1137	Die Cast	1/2"
1138	Die Cast	3/4"
1140	Die Cast	1/2" - 3/4"

7" Long Diverter & Tub Spouts

- Available in four styles
- Chrome plated die cast
- Individually boxed
- Diverter are front lift
- IPS are front mount
- CWT are slip fit



Available in polished brass
add "B" to part number

PART NUMBER	DIVERTER	PIPE SIZE
11287	Yes	1/2" IPS
11347	No	
11367	No	1/2" CWT
11427	Yes	

Extensions for Tub & Diverter Spouts

- Chrome Plated**
- Spouts not included



Made in U.S.A.

PART NUMBER	FINISH	LENGTH
1155	Chrome	3"
1156	Chrome	3"



Fiberlass Shower Arm Ell

This brass ell securely mounts a shower arm to a fiberglass shower stall. Also can be used to secure a tub spout nipple. Can be used with copper, iron pipe or compression fittings. Prevents movement of shower arm and tub spout.

- Locknuts secure ell to fiberglass wall
- Requires 1-1/32" hole through fiberglass
- Outlet end 1/2" FIP
- Inlet end 1/2" CWT or 1/2" MPT

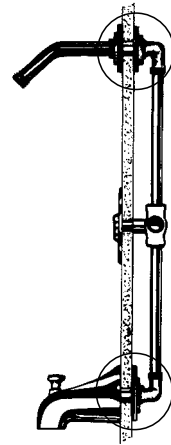

PART NUMBER
1195

Bathcock Coupling

- 1/2" MPT
- Satin finish brass
- Sold by the pair



PART NUMBER
1793

Solid Brass Twin Ell

For use with Diverter Spouts



PART NUMBER	SIZE NPT		
	SPOUT	IN	SHOWER
1145	3/4"	1/2"	1/2"

Diverter Spout

For Hand Held Shower

- Chrome plated die cast
- 1/2" male hose adapter included for hand shower hose
- 1/2"-3/4" IPS Back mount



PART NUMBER	FIP	PROTUSION FROM WALL
1133	1/2" or 3/4"	5-1/8"

Bath Supplies for 4 Leg or Old Style Bath Tubs

2 Styles With Nuts and Washers



1/2" Chrome plated copper

PART NUMBER	DESCRIPTION
1792	90° Single Bend for 3-3/8" Centers
17925	Offset Bend for 3-3/8" to 4" Centers
1794	KIT ONLY 2 each of nuts, cone washers & friction rings



Shower Valve Rebuild Kits

For the most popular brands. These conveniently packed kits contain all parts needed to rebuild shower valves.

Price Pfister Verve®

- 3 Handle Valve w/ Diverter
- Sold complete as shown
- Seats included
- Parts not sold separately



PART NUMBER	DESCRIPTION
28314	Two Handle
28315	Three Handle

Sayco®

- 3 Handle Valve w/ Diverter
- Sold complete as shown
- Seats included
- Parts not sold separately



PART NUMBER
28317

American Standard - Colony®

- 3 Handle Valve w/ Diverter
- Sold complete as shown
- Seats included
- Parts not sold separately



PART NUMBER	STEM LENGTH
28310	Short
28311	Long

American Standard - Aquaseal®

- 3 Handle Valve w/ Diverter
- Sold complete as shown
- Seats included
- Parts not sold separately



PART NUMBER
28312

Shower Valve Rebuild Kits

For the most popular brands. These conveniently packed kits contain all parts needed to rebuild shower valves.

Gerber®

- 3 Handle Valve w/ Diverter
- Sold complete as shown
- Seats included
- Parts not sold separately

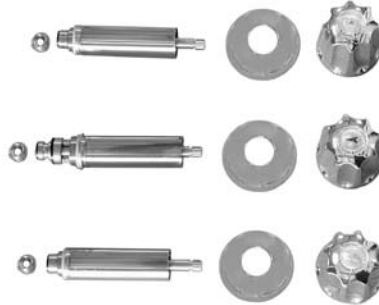

PART NUMBER	DESCRIPTION
28319	Canopy
28320	Cross (not shown)

Sterling®

- 3 Handle Valve w/ Diverter
- Sold complete as shown
- Seats included
- Parts not sold separately



PART NUMBER
28318

Kohler®

- 2 Handle Valve
- Sold complete as shown
- Seats included
- Parts not sold separately



PART NUMBER
28321

Central Brass®

- 3 Valve Diverter
- Sold complete as shown
- Seats included
- Parts not sold separately

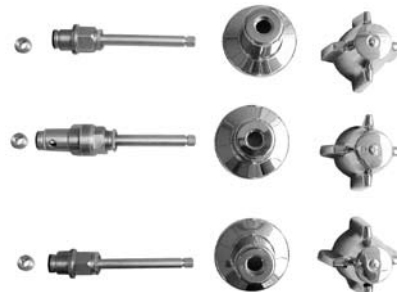

PART NUMBER
28322

NOTE: Please do not confuse PASCO Specialty & Mfg., Inc. with these companies. PASCO is an independent manufacturing distributor of quality plumbing specialty products, which, although may not be manufactured by the original product manufacturer, are precision made.



Simply The Best Shower Head

- 1/2" FPT
- Easily adjusts from fine to peppery spray
- Chrome plated brass ball joint
- Vandal resistant
- #1167 - 2.5 GPM @ 70 PSI
- #1167RF - 1.5 GPM @ 70 PSI
- Removable filter screen prevents clogging of spray



PART NUMBER
1167
1167RF

Economy Shower Head

- 1/2" FPT
- 1.5 GPM @ 70 PSI
- Chrome plated plastic
- Adjustable



PART NUMBER
1189-RF

Shower Arm Shut Off

- 1/2" MPT x 1/2" FPT
- Chrome plated brass

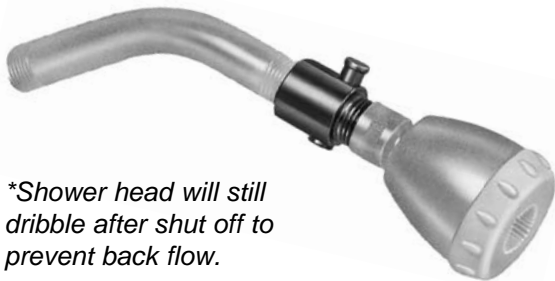

**Shower head will still dribble after shut off to prevent back flow.*

PART NUMBER
1168

High Rise Shower Arm

- Increases height of any shower head
- Chrome plated brass
- 1/2" IPS



Sold less shower head and flange.

PART NUMBER	HEIGHT
1190	10"
1191	8"

Shower Arms

- Chrome plated brass
- 1/2" IPS - Heavy wall thickness



PART NUMBER	HEIGHT
1185	6"
1186	8"
1193	10"

Shower Arm Flanges



PART NUMBER	FLANGE STYLE	FINISH
1182	Sure Grip	CP Steel
1187	Set Screw	CP Die Cast

Face Bushings - IPS and CWT (Solder Type)



PART NUMBER	MATERIAL	SIZE
1139	Plastic	3/4" x 1/2" IPS
1141	Brass	3/4" x 1/2" IPS
1146	Brass	1/2" x 3/8" IPS
1317	Brass	1/2" IPS x 1/2" CWT
1318	Brass	3/4" IPS x 3/4" CWT
1319	Brass	1" IPS x 1" CWT

Diverter Spouts Lift Replacement

Fits Spouts:

1128, 1134, 1136, 11287, 11427
1142, 1143 & 1144

- Brass lift
- Rubber washer
- Plastic slide
- Installs in seconds

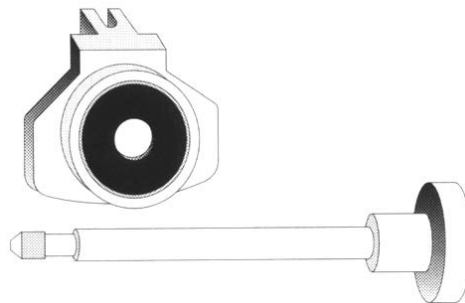

PART NUMBER
1109

Adjustable Shower Arm

- 1/2" MPT x 1/2" FPT
- 10" Length
- Chrome plated brass

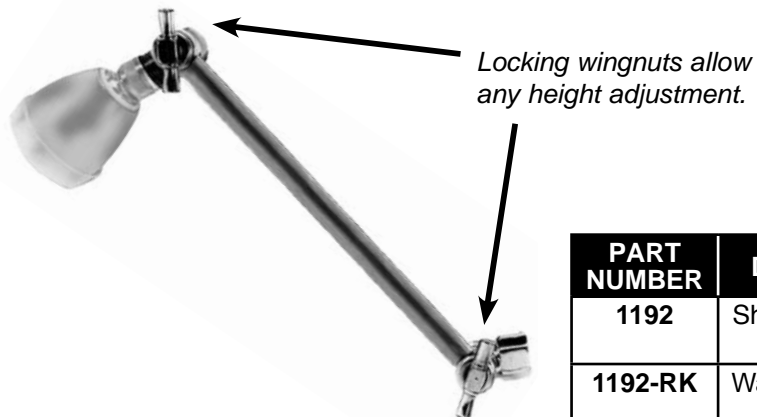

PART NUMBER	DESCRIPTION
1192	Shower arm LESS shower head
1192-RK	Washers and Gas-kets



**Add-A-Shower:
Over the Rim**

- Chrome plated die cast spout
- 1/2" IPS

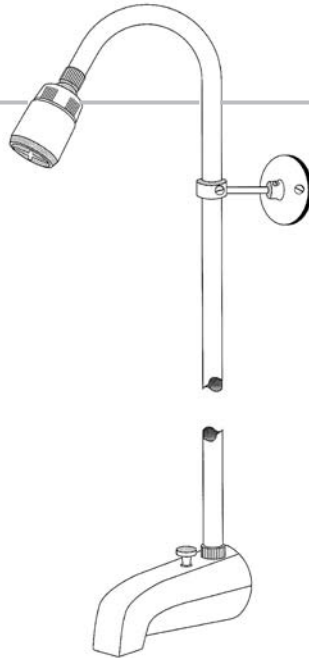

PART NUMBER	DESCRIPTION
2825	Over the rim supplied complete as shown

Replacement Parts

2831	Spout ONLY
1246	Wall Bracket
2836-3	3/8" x 60" CP Brass Riser
1189-RF	Shower Head w/Bushing

Add-A-Shower: Regular Style

- Chrome plated brass bathcock
- Specifically for 4 leg bathtubs

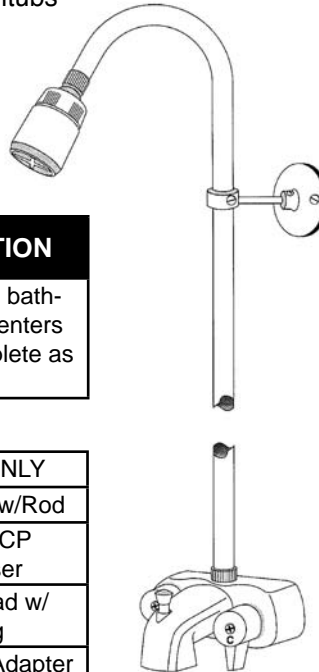

PART NUMBER	DESCRIPTION
2826	Regular style bathcock 3-3/8" centers supplied complete as shown

Replacement Parts

2832	Bathcock ONLY
1247	Wall Bracket w/Rod
2836-3	3/8" x 60" CP Brass Riser
1189-RF	Shower Head w/Bushing
1258	Rod-to-Riser Adapter
2837-C	Cold Stem
2837-H	Hot Stem
2837	Bathcock Seats-Pair
2839	Hot & Cold Handle Set

Add-A-Shower: Non-Siphon

- Complies with UPC
- Spout rises above rim of tub

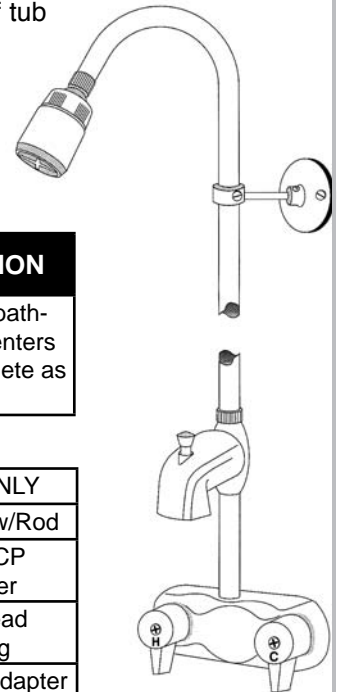

*Complies with UPC

PART NUMBER	DESCRIPTION
2827*	Non-Siphon bathcock 3-3/8" centers supplied complete as shown

Replacement Parts

2833	Bathcock ONLY
1247	Wall Bracket w/Rod
2836-3	3/8" x 60" CP Brass Riser
1189-RF	Shower Head w/Bushing
1258	Rod-to-Riser Adapter
2837-C	Cold Stem
2837-H	Hot Stem
2838	Bathcock Seats-Pair
2839	Hot & Cold Handle Set

Straight Shower Rods

- 1" Diameter



PART NUMBER	ROD LENGTH	DESCRIPTION
1260	60"	Polished Aluminum
1261	72"	LESS Flange
1282	60"	CP Brass
1283	72"	WITH Flange
1282-PB	60"	Polished Brass
1283-PB	72"	WITH Flange

Corner Shower Rods

- 1" Diameter
- Jumbo flanges
- Individually boxed

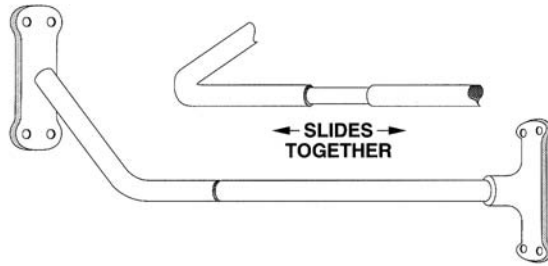

PART NUMBER	ROD LENGTH	DESCRIPTION
1262	60" x 27"	Polished Aluminum
1263	72" x 27"	Polished Aluminum
1284	60" x 27"	Chrome Plated Brass
1285	72" x 27"	Chrome Plated Brass

"D" Style Shower Rods

- 1" Diameter
- Round flanges & 36" Ceiling support
- Individually boxed

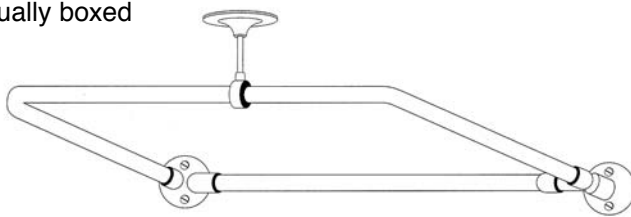

PART NUMBER	ROD LENGTH	DESCRIPTION
1264	54" x 27"	Polished Aluminum
1265	60" x 27"	Polished Aluminum
1286	54" x 27"	Chrome Plated Brass
1287	60" x 27"	Chrome Plated Brass

Rectangular Shower Rods

- 1" Diameter
- 1-36" Ceiling support
- 1-10" Wall support
- Round flanges
- Individually boxed

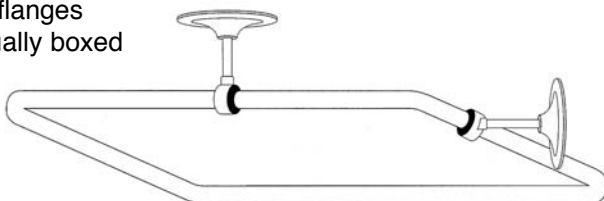

PART NUMBER	ROD LENGTH	DESCRIPTION
1271	48" x 27"	Polished Aluminum
1272	54" x 27"	Polished Aluminum
1288	48" x 27"	Chrome Plated Brass
1289	54" x 27"	Chrome Plated Brass



Ceiling Supports

For 1" Shower Rods

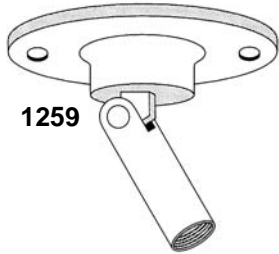

1259

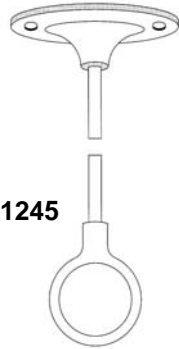

1245

PART NUMBER	DESCRIPTION
1259	36" Fit-all ceiling support complete
1245	Hinged ceiling support for angled ceilings - fits 1259 rods CP Brass, sold less rod
1249	Ceiling flange ONLY
1267	1" Loop ONLY

Shower Curtain Pins

Also Use For Valve ID Tags

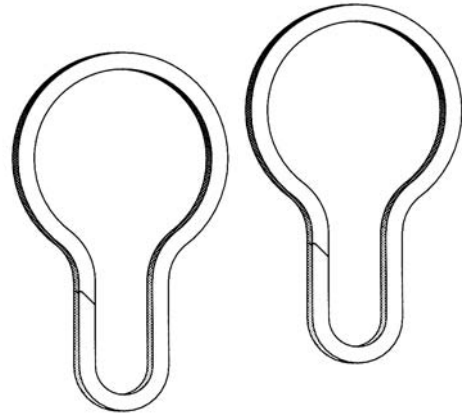

PART NUMBER	SIZE	MATERIAL
1188	#3	Nickel Plated Steel

Flanges

For 1" Shower Rods

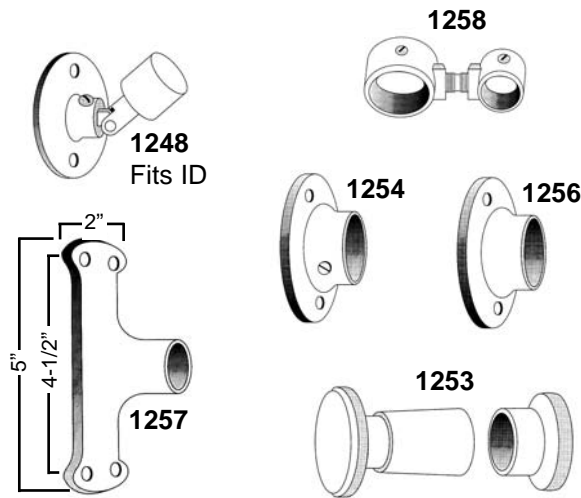

PART NUMBER	DESCRIPTION
1248	Hinged wall CP brass with screws
1253	Adjustable CP plastic
1254	With set screw CP steel
1256	Sure grip CP steel
1257	Jumbo CP die cast
1258	Riser to Rod Support

Add-A-Shower Riser Brackets

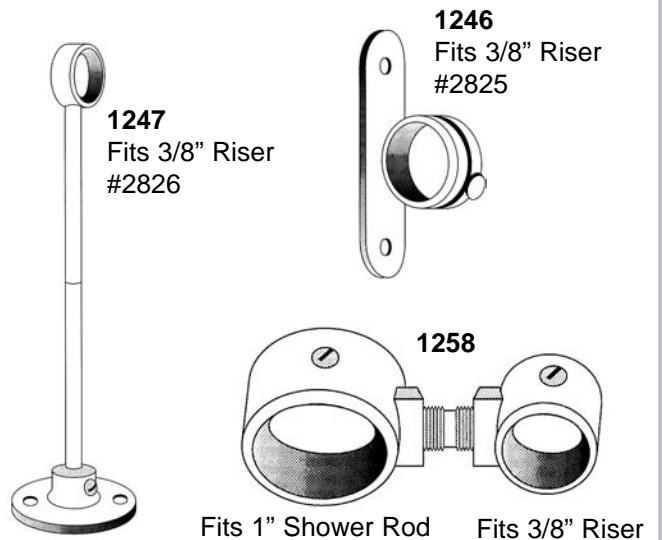

PART NUMBER	DESCRIPTION
1246	Fixed wall brackets for risers
1247	Brackets for risers
1258	Rod to riser coupling
1269	Rod Coupling for 1264 & 1265

Quick Valve Plate

Stainless Steel Shower Valve Cover Plate

Old ceramic tile is impossible to match. The Quick Valve Plate covers the unsightly hole left in the tile after the shower valve is replaced.

- Screws & brackets provided
- Polished stainless steel not affected by household cleaners
- 13" long X 7-1/4" wide



Stainless Steel

PART NUMBER	HOLES	HOLE SIZE OR CENTERS
815	1	5"
816	2	8" Centers
817	3	
818	1	3-1/2"
819	1	4-1/2"
820	0	no holes

Polished Brass Finish

815-PB	1	5"
816-PB	2	8" Centers

Overflow Plate - Chrome

With Trip Lever

- Square handle
- Covers 3-1/4" hole
- 2" bolt hole centers



PART NUMBER	W/1148 BOLTS
1150	None
1157	2

Overflow Plate - Chrome

- Covers 3-1/4" hole
- 2" bolt hole centers



PART NUMBER	W/1148 BOLTS
1154	None
1160	2

Overflow Plate - Chrome

- Covers 3-1/4" hole



PART NUMBER	W/1148 BOLTS
1152	None
1159	1

Overflow Plate Bolt - Chrome

For trip lever and overflow face plates

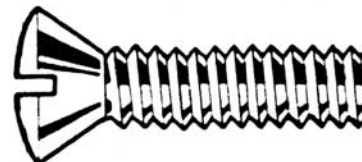

PART NUMBER	SIZE/LENGTH
1147	1/4" x 20 x 2-1/2"
1148	1/4" x 20 x 1-1/2"
1149	1148 - 2 per bag



Tub Strainer

- Three Prong
- Stainless steel



PART NUMBER	DIAMETER
1342	1-7/8"
1343	1-5/8"

Overflow Strainer

- For 4 leg tubs
- 3" Diameter
- CP Brass



PART NUMBER
1357

Bead Chain

- CP Brass



PART NUMBER	REEL LENGTH
1124	250 ft.



PART NUMBER	CHAIN SIZE
1130	# 10

Bath Tub Waste Shoe & Strainer

- Brass
- 22 Gauge tube
- Price Pfister style



PART NUMBER	DESCRIPTION
1372	1-1/2" Brass Waste Shoe
1373	1-3/8" Brass Waste Shoe
1374	16 Thread Tub Drain Body w/Cross
1374-W	Tub Drain Washer
1376	Stainless Steel Strainer w/Bolt
1377	CP Brass Bolt for Strainer ONLY
1380	1-1/2" Brass Waste Shoe - Complete
1381	1-3/8" Brass Waste Shoe - Complete

P Traps

All 17 gauge P Traps have CP brass nuts.
All 20 gauge P Traps have CP die cast nuts.

Less Cleanout - 8" Wall Bend - Chrome

- Beaded with slip joint washers or ground joint

Add 15 to part number for 15" wall bend
Add BF for box flanges



30 pieces per case
*Choked inlet



PART NUMBER	SIZE	GAUGE
34100	1-1/4"	20
*34102	1-1/2" x 1-1/4"	
34104	1-1/2"	
34106	1-1/4"	17
*34108	1-1/2" x 1-1/4"	
34110	1-1/2"	

Rough Brass

34105	1-1/2"	20
34107	1-1/2"	17

Ground Joint - Chrome

34109	1-1/2" x 1-1/4"	17
34111	1-1/2"	

With Cleanout - 8" Wall Bend - Chrome

- Beaded with slip joint washers or ground joint

Add 15 to part number for 15" wall bend
Add BF for box flanges



30 pieces per case
*Choked inlet



PART NUMBER	SIZE	GAUGE
34116	1-1/4"	20
*34118	1-1/2" x 1-1/4"	
34120	1-1/2"	
34122	1-1/4"	17
*34124	1-1/2" x 1-1/4"	
34126	1-1/2"	

Ground Joint - Chrome

34129	1-1/2"	17
-------	--------	----

Wall Bend for P Trap - Chrome



PART NUMBER	SIZE	GAUGE
34128	1-1/4" x 8"	20
34130	1-1/2" x 9"	
34132	1-1/2" x 15"	
34136	1-1/2" x 9"	17
34138	1-1/2" x 15"	



Sink Traps

All 17 gauge Sink Traps have CP Brass nuts. All 20 gauge Sink Traps have CP Die Cast nuts.

Sink Traps with Cast Brass Outlet Elbow - Chrome



PART NUMBER	SIZE	GAUGE	CASE QTY
34172	1-1/4"	20	40
34174	1-1/2"		40
34176	1-1/4"	17	40
34178	1-1/2"		30

IPS cast elbow ONLY

34141	1-1/2"
-------	--------



J Bends for Sink Traps with Captured Nut - Chrome



50 pieces per case

PART NUMBER	SIZE	GAUGE
34182	1-1/2"	20
34186	1-1/2"	17



Sink Trap w/PVC Connection Cast Brass Outlet Elbow

- Chrome trap and cover tube
- PVC Connection
- 20 Gauge Trap



PART NUMBER	SIZE	CASE QTY
34145	1-1/2" x 5"	30

J Bends for P Traps - Chrome



50 pieces per case
† 30 pieces per case



Without Cleanout *Reducing Washer		
PART NUMBER	SIZE	GAUGE
34188	1-1/4"	20
*34190	1-1/2"	
34191	1-1/2" x 1-1/4"	
*34192	1-1/4"	17
34193	1-1/2" x 1-1/4"	
34194	1-1/2"	
Low Inlet		
34197	1-1/2"	17
Choked Inlet		
34201	1-1/2" x 1-1/4"	20
34205	1-1/2" x 1-1/4"	17
High Inlet †		
34209	1-1/4"	17
34211	1-1/2"	17



**Los Angeles Code Sink Trap
Cast Brass Elbow - Ground Joint**

- Brass nuts and 1-1/2" x 1-1/4" reducing washer



50 pieces per case

Complete

PART NUMBER	SIZE	FINISH	GAUGE
34140	1-1/2"	Chrome	17
34142	1-1/2"	Rough	

"J" bend ONLY for LA trap

34137	1-1/2"	Chrome	17
34139	1-1/2"	Rough	

PART NUMBER	DESCRIPTION
34140	1-1/2" CP outlet blbow ONLY

S Traps with Flanges - Less Cleanout - Chrome

To receive with deep box flange, add "BF" to part number.

- All 17 gauge traps have CP brass nuts.
- All 20 gauge traps have CP die cast nuts.



PART NUMBER	SIZE	TRAP GAUGE	CASE QTY
34144	1-1/4" x 20"	20	24
34146	1-1/2" x 20"		20
34148	1-1/4" x 20"	17	20
34150	1-1/2" x 20"		18

Cast Tees with Tailpieces - Nuts & Washers - 1-1/2" Chrome



34314

34320

34316
34318

34312



50 pieces per case

Add RB to part number for Rough Brass

PART NUMBER	SIZE
34312	1-1/2" CP outlet blbow ONLY
34314	1-1/2" Rough outlet elbow ONLY
34316	Center outlet tee no baffle
34318	Center outlet tee w/ baffle
34320	3 Way slip tee no baffle
34322	1-1/2" Hiway insert tailpiece TOE



Continuous Wastes

All 17 gauge Slip Joint Cast Tee's have CP Brass nuts.
 All 20 gauge Slip Joint Cast Tee's have CP Die Cast nuts.

Continuous Waste - End Outlet, Slip Joint Cast Tee

- With Baffle - Chrome
- *Los Angeles Code Compliant



30 pieces per case



PART NUMBER	SIZE	FINISH	GAUGE
34160	1-1/2" x 16"	Chrome	20
34162	1-1/2" x 21"	Chrome	
34164	1-1/2" x 16"	Rough	17
34167	1-1/2" x 16"	Rough	
34168	1-1/2" x 16"	Chrome	
* 34169	1-1/2" x 16"	Chrome	
34170	1-1/2" x 21"	Chrome	

Continuous Waste - End Outlet, Direct Connect Cast Tee

- With Baffle - Chrome



30 pieces per case



PART NUMBER	SIZE	GAUGE
34286	1-1/2" x 16"	20
34290	1-1/2" x 16"	17
34292	1-1/2" x 21"	

Continuous Waste - Center Outlet, Slip Joint Cast Tee

- With Baffle - Chrome



PART NUMBER	SIZE	GAUGE	CASE QTY
34294	1-1/2" x 16"	20	24
34298	1-1/2" x 16"	17	20
34300	1-1/2" x 21"		20

Continuous Waste - Center Outlet, Direct Connect Cast Tee

- With Baffle - Chrome



PART NUMBER	SIZE	GAUGE	CASE QTY
34302	1-1/2" x 16"	20	24
34306	1-1/2" x 16"	17	20

Waste Arms

All 17 gauge Waste Arms have CP Brass nuts.
 All 20 gauge Waste Arms have CP Die Cast nuts.

1-1/2" Waste Arms - Slip Joint

• Rough and Chrome



7" 60 pieces per case
 11-1/2" 50 pieces per case
 15" 40 pieces per case
 20" 30 pieces per case
 24" 24 pieces per case

PART NUMBER	SIZE	FINISH	GAUGE
34204	7"	Chrome	20
34206	11-1/2"		
34208	15"		
34210	20"		
34212	24"		
34216	7"	Rough	20
34218	11-1/2"		
34220	15"		
34222	20"		
34224	24"	Chrome	17
34226	7"		
34228	11-1/2"		
34230	15"		
34232	20"	Rough	17
34234	24"		
34238	11-1/2"		
34240	15"		
34244	24"		

1-1/2" Waste Arms - Slip Joint

• Rough and Chrome



7" 60 pieces per case
 11-1/2" 30 pieces per case
 15" 40 pieces per case
 20" 30 pieces per case
 24" 24 pieces per case

PART NUMBER	SIZE	FINISH	GAUGE
34246	7"	Chrome	20
34248	11-1/2"		
34250	15"		
34252	20"		
34254	24"		
34256	7"	Rough	20
34262	20"		
34264	24"		
34266	7"	Chrome	17
34270	15"		
34274	24"		
34276	7"	Rough	17
34278	11-1/2"		



Sink Tailpieces - Flanged One End

• Rough and Chrome



4" 80 pieces per case
 6" 60 pieces per case
 8" 60 pieces per case
 12" 50 pieces per case

PART NUMBER	LENGTH	DIAMETER	FINISH	GAUGE
34326	6"	1-1/4"	Chrome	20
34328	8"			
34330	12"			
34332	4"	1-1/2"	Chrome	20
34334	6"			
34336	8"			
34338	12"			
34340	4"	1-1/2"	Rough	20
34342	6"			
34344	8"			
34346	12"	1-1/2"	Chrome	17
34348	4"			
34350	6"			
34352	8"			
34354	12"	1-1/2"	Rough	17
34356	4"			
34358	6"			
34360	8"			
34362	12"			

Sink Tailpieces - Double End Flanged

• 1-1/2" - Chrome



12" 50 pieces per case
 16" 40 pieces per case
 * Rough Brass

PART NUMBER	LENGTH	GAUGE
34364	12"	20
34366	16"	
* 34367	16"	17
34388	16"	

Sink Tailpieces - Reducing

• 1-1/2" x 1-1/4" - Chrome



60 pieces per case

PART NUMBER	LENGTH	GAUGE
34390	8"	20
34392		17

Extension Tube - Slip Joint

- Double End - Chrome
- With CP die cast nuts
- 40 Pieces per case



40 pieces per case

PART NUMBER	SIZE	GAUGE
34394	1-1/4" x 16"	20
34396	1-1/2" x 16"	

Extensions Tubes - Slip Joint, With Nuts & Washers

- All 17 gauge Slip Joint Extension Tubes have CP brass nuts
- All 20 gauge Slip Joint Extension Tubes have CP die cast nuts



6" 80 pieces per case
 8" 60 pieces per case
 12" 50 pieces per case

PART NUMBER	LENGTH	FINISH	GAUGE	FINISH
34398	6"	1-1/4	20	Chrome
34400	8"			
34402	12"			
34404	6"	1-1/4	17	Chrome
34406	8"			
34408	12"			
34410	6"	1-1/2"	20	Chrome
34412	8"			
34414	12"			
34416	6"	1-1/2"	17	Chrome
34418	8"			
34420	12"			
34422	12"	1-1/2"	17	Rough



Extension Tubes - Threaded Both Ends

• Rough and Chrome



* Extension tube - threaded one end - (TOE)



6" 80 pieces per case
8" 60 pieces per case
12" 50 pieces per case

PART NUMBER	LENGTH	DIAMETER	FINISH	GAUGE
34448	6"	1-1/4"	Chrome	20
34450	8"			
34452	12"			
34456	8"	1-1/4"	Rough	20
34458	12"			
34460	6"	1-1/4"	Chrome	17
34461	6"			
34462*	8"			
34464	12"	1-1/2"	Chrome	20
34467	3-3/4"			
34468	6"			
34470	8"	1-1/2"	Rough	20
34472	12"			
34474	6"			
34476	8"	1-1/2"	Chrome	17
34478	12"			
34480	12"			
34482	12"	1-1/2"	Rough	17

Repair Couplings & Ells

• Chrome - With CP die cast nuts



25 pieces per case

PART NUMBER	DESCRIPTION	SIZE
34518	Straight	1-1/4
34520	90°	
34522	45°	
34524	Straight	1-1/2
34526	90°	
34528	45°	

Double Offset 12"

• With die cast nuts



24 pieces per case

PART NUMBER	LENGTH	GAUGE	FINISH
34530	1-1/4"	20	Chrome
34532	1-1/2"		Chrome
34534	1-1/2"		Rough

Slip Joint Chrome Repair Traps

- Less Cleanout



PART NUMBER	LENGTH	GAUGE
34484	1-1/4"	20
34486	1-1/2"	

Replacement elbow ONLY

PART NUMBER	LENGTH	GAUGE
34488	1-1/4"	20
34490	1-1/2"	

Slip Joint Elbows

- With CP die cast nuts



PART NUMBER	LENGTH	DIAMETER	GAUGE	FINISH
34492	4"	1-1/2"	20	Chrome
34496	8"			
34498	12"			

Closet Ells

- With CP die cast nuts

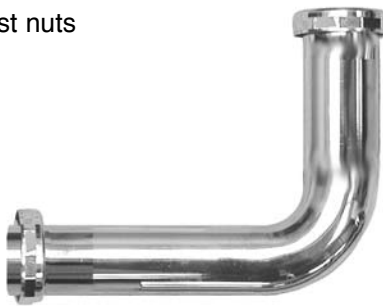

PART NUMBER	SIZE	GAUGE	FINISH
34512	2" x 4" x 6"	20	Chrome
34514	2" x 5" x 7"		
34516	2" x 6" x 8"		
34517 *	2" x 3" x 10"		

* Two-Piece Repair Ell

Branch Tailpieces

- Branch for 5/8" and 7/8" dishwasher drain hose



PART NUMBER	BRANCH OUTLET	SIZE	GAUGE	STYLE	TAILPIECE FINISH
34540	7/8"	1-1/2" X 8"	17	Chrome Plated Brass Nut Captive	Chrome Plated
34541	5/8"				
34542	7/8"	1-1/2" X 8"	20	Chrome Plated Diecast Nut Slip Joint Down	Rough Brass
34543	5/8"				
34544	7/8"	1-1/2" X 8"	20	Chrome Plated Diecast Nut Slip Joint Down	Chrome Plated
34545	5/8"				



Cast Swivel Trap - Cleanout - Brass Nuts

- Chrome
- IPS Elbow
- Ground Joint
- LA Code



25 pieces per case

PART NUMBER	SIZE	GAUGE
34570	1-1/2"	17

Disposal Kit - 13" Center to End

- Chrome
- With baffle tee
- 17 gauge with CP brass nuts
- 20 gauge with CP die cast nuts



30 pieces per case

PART NUMBER	LENGTH	GAUGE
34546	1-1/2"	20
34548	1-1/2"	17

Semi-Cast Traps - Cleanout - Brass Nuts

- Chrome
- 9" Wall Bend



With Shallow Flange

PART NUMBER	SIZE	GAUGE
34550	1-1/4"	17
34554	1-1/2"	

With Box Flange

PART NUMBER	SIZE	GAUGE
34556	1-1/4"	17
34558	1-1/2"	

With Ground Joint

PART NUMBER	SIZE	GAUGE
34560	1-1/4"	17
34562	1-1/2"	

20 pieces per case



Commercial Grid Style Lavatory Drain

Highest Quality

- #1175 & 1179 Chrome plated brass body
- #1176 Stainless steel body
- 1-1/4" Stainless steel tailpiece
- Brass locknut
- Rubber gasket with overflow



Individually Boxed
* Most Popular

PART NUMBER	TAILPIECE LENGTH
1175	4"
1176*	6"
1179	12"

Handicap Commercial Grid Style Lavatory Drain

Highest Quality

- Chrome plated brass body
- 1-1/4" x 9" Stainless steel tailpiece
- Brass locknut
- Rubber gasket with overflow



PART NUMBER	DESCRIPTION
1177-TP	With Tailpiece
1177	Elbow ONLY

Flexible PVC Tubular Trap

- There's no faster, easier way to replace 1-1/4" or 1-1/2" plastic or metal drain traps. It's flexible PVC material adjusts to pipe misalignment and in installs quickly and securely with a common screwdriver or nutdriver.
- Stainless steel clamps



PART NUMBER	DRAIN SIZE
5900	1-1/4" or 1-1/2" to 1-1/2"

Flexible PVC Trap Adapters

- Trap connectors are ideal for new installation, repairs and alterations.
- The 5915 size connects 1-1/4" or 1-1/2" tubular traps to all common 1-1/4" or 1-1/2" drain piping.
- The 5925 size connects 1-1/4" or 1-1/2" tubular traps to all common 2" drain piping, except copper. (For 2" copper, use 5915)
- Stainless steel clamps



PART NUMBER	DRAIN SIZE
5915	1-1/4" and 1-1/2"
5925	1-1/4" or 1-1/2" to 2"

Flexible PVC Tubular Drain Pipe Connector

- For any combination of 1-1/2" or 1-1/4" tubular drain pipe.
- Stainless steel clamps



PART NUMBER	DRAIN SIZE
5905	1-1/4" and 1-1/2"

PVC Hose Grip Clothes Washer Connector

- Holds washing machine hoses securely in their standpipe drains.
- The Hose Grip has 4 vents to allow for air flow during discharge from washer.
- Stainless steel clamp



PART NUMBER
5930



2" Quick Set Shower Drain

For Fiberglass Shower Stalls

- Internal locknut and gasket for 2" DWV
- Chrome plated brass strainer
- Brass body and locknut



PART NUMBER	PIPE SIZE
7980	2"

Brass Utility Drain



PART NUMBER	IPS
1170	1-1/2"
1171	2"

Plastic Shower Drain

Clamping Ring Style

- 4" diameter strainer
- 2" IPS plastic tailpiece allows adjustment to desired level
- Fits over 2" or inside 3" Schedule 40 DWV



PART NUMBER	MATERIAL	DRAIN CONNECTION	TOP FLANGE DIAMETER	BOTTOM FLANGE DIAMETER
8015	PVC	2"-3" PVC	5-1/4"	6-1/2"
8016	ABS	2"-3" ABS		
8019	4" Stainless Steel Strainer			

Sure Grip Flanges (or Shallow Flanges)

- Box Quantities Only - 50 per box



Chrome Plated Steel

PART NUMBER	IPS	CWT	OUTSIDE DIAMETER
1224	1-1/2" Tubular		3"
1225	3/8"	—	2-1/2"
1226	1/2"	—	2-1/2"
1227	3/4"	—	2-1/2"
1228	1-1/2"	—	3"
1229	2"	—	3-1/4"
1230	—	1/2"	2-1/2"
1231	—	3/4"	2-1/2"
1232	1-1/4"	1-1/2"	3"
1233	1"	—	2-3/4"
1240	—	2"	3-1/2"
1241	—	1"	2-3/4"
1244	1-1/4" Tubular		3"

Stainless Steel

1226-SS	1/2"	—	2-1/2"
1227-SS	3/4"	—	2-1/2"
1228-SS	1-1/2"	—	3-1/2"
1229-SS	2"	—	3-1/2"
1230-SS	—	1/2"	2-1/2"
1231-SS	—	3/4"	2-1/2"

White Plastic Sure Grip Flanges (or Shallow Flanges)

- Low Cost
- Corrosion-proof, indestructible, high-density polyethylene
- Box Quantities Only - 50 per box



PART NUMBER	IPS	CWT	TUBULAR	OUTSIDE DIAMETER
1208	—	3/8"	—	2-1/4"
1209	—	1/2"	—	2-1/4"
1210	—	3/4"	—	2-1/4"
1211	3/8"	—	—	2-3/8"
1212	1/2"	—	—	2-3/8"
1213	3/4"	—	—	2-3/8"
1214	1-1/2"	—	—	3"
1215	2"	—	—	3-1/2"
1216	—	—	1-1/4"	2-7/8"
1217	—	—	1-1/2"	2-7/8"



Extra Wide Sure Grip Flanges (or Shallow Flanges)

Chrome Plated Steel

- Box Quantities Only - 50 per box



PART NUMBER	IPS	TUBULAR	OUTSIDE DIAMETER
1238	1-1/2"	—	3-1/2"
1239	2"	—	3-1/2"
1240	—	2"	3-1/2"

Sure Grip Box Flanges

• Chrome Plated OR Stainless Steel

- Box Quantities Only - 50 per box



Chrome Plated Steel

PART NUMBER	IPS	TUBULAR	OUTSIDE DIAMETER
1234	1-1/4"	—	3"
1235	1-1/2"	—	3"
1236	—	1-1/4"	3"
1237	—	1-1/2"	3"

SPECIFY SUFFIX "SS" FOR STAINLESS STEEL

Sure Grip Bell Flanges (or Deep Flanges)

Chrome Plated Steel

- Box Quantities Only - 25 per box



PART NUMBER	IPS	CWT	TUBULAR	OUTSIDE DIAMETER
2841	3/8"	—	—	2-1/2"
2842	1/2"	—	—	2-1/2"
2844	1-1/4"	—	—	3"
2845	—	1/2"	—	2-1/2"
2846	1-1/2"	—	—	3"
2848	—	3/8"	—	2-1/2"
2853	—	—	1-1/4"	3"
2854	—	—	1-1/2"	3"

Sure Grip Floor and Ceiling Plate

Chrome Plated Steel

- Light pattern - no springs



PART NUMBER	IPS	CWT	OUTSIDE DIAMETER
2810	3/8"	—	3"
2811	1/2"	—	2-3/4"
2812	3/4"	—	2-3/4"
2813	1"	—	3-1/2"
2814	1-1/4"	1-1/2"	3-1/2"
2815	1-1/2"	—	3-1/2"
2816	2"	—	4-1/2"
2820	—	3/8"	2-3/4"
2821	—	1/2"	3"
2822	—	3/4"	2-3/4"
2823	—	1"	2-3/4"
2824	—	1-1/4"	3-1/2"

Plastic Floor and Ceiling Plate - Chrome Plated or White

- Simply bend and place around pipe.
- Chrome or white finish 100% Rustproof
- Non-corrosive
- Non-breakable

SPECIFY SUFFIX "W" FOR WHITE



PART NUMBER	IPS	CWT	OUTSIDE DIAMETER
2856	1/2"	—	2-3/4"
2857	3/4"	—	3"
2858	1"	—	3-1/4"
2859	1-1/4"	—	3-1/2"
2860	1-1/2"	—	4-1/4"
2861	2"	—	5-1/4"
2862	2-1/2"	—	5-3/4"
2863	3"	—	5-3/4"
2864	4"	—	6-3/4"
2865	5"	—	8-1/2"
2866	6"	—	9-3/4"
2868	8"	—	12-3/4"
2873	—	1/2"	2-1/2"
2874	—	3/4"	2-3/4"
2875	—	1"	3"
2876	—	1-1/4"	3-1/4"
2877	—	1-1/2"	3-1/2"
2878	—	2"	4-1/2"

Floor and Ceiling Plate

Heavy Pattern With Springs - Hinged

- Chrome plated steel



PART NUMBER	IPS	CWT	OUTSIDE DIAMETER
2880	3/8"	—	2-1/4"
2881	1/2"	—	2-3/4"
2882	3/4"	—	2-3/4"
2883	1"	—	3-1/4"
2884	1-1/4"	—	3-1/2"
2885	1-1/2"	—	4"
2886	2"	—	4-1/2"
2888	—	1/2"	2-1/4"
2889	2-1/2"	—	5-1/2"
2890	3"	—	6"
2891	—	3/4"	2-3/4"
2892	4"	—	6-1/2"
2893	—	1"	3-1/4"
2894	—	1-1/4"	3-1/2"
2895	—	2"	4-1/2"
2896	—	1-1/2"	4"
9860	5"	—	9"
9861	6"	—	9-3/4"
9862	8"	—	13"



**Plastic
Dryer Vent Hood**

With 4" Aluminum Duct Pipe and Wall Flange

- Weather resistant
- Paintable
- Wide outlet



**PART
NUMBER**
1718-W

**Plastic
Louvere Dryer Vent Hood**

With 4" Aluminum Duct Pipe and Wall Flange

- Weather resistant
- Paintable
- Narrow profile
- Prevents drafts

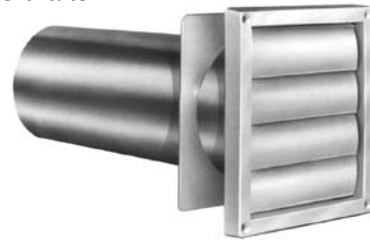

**PART
NUMBER**
1721-W

Vent Hood Kit

With Above Hood #1718-W

- 1- 4" x 5 ft. Vinyl or Aluminum Dryer Duct
- 2- #1724 Clamps
- 1- #1718-W Vent Hood

PART NUMBER	DESCRIPTION
1697	Aluminum
1718-HK	Vinyl

Vinyl or Aluminum Dryer Duct



PART NUMBER	MATERIAL	SIZE
1687	Aluminum	4" x 5 ft.
1688		4" x 8 ft.
1689		4" x 25 ft.
1720	Vinyl	4" x 20 ft.

Dryer Duct Clamp

Stainless Steel



PART NUMBER	SIZE
1723	4"

Anchor Sets

Phillips hex head screws allow a nutdriver, nut setter or screwdriver to be used.

EACH SET CONTAINS:

- 100 Anchors
- 100 Phillips hex head screws
- Carbide tipped masonry drill (optional)
- Transparent, reusable box



PART NUMBER	DRILL INCLUDED	SCREW SIZE	ANCHOR SIZES	STYLE
1598	3/16"	1" x #6	4 - 6	Collar
1600	1/4"	1" x #10	8 - 10	
1604	1/4"	1" x #10	10 - 12	No Collar

Toggle Bolts

- 50 per box



PART NUMBER	SIZE
1479	3/16" x 4"
1484	1/4" x 3"
1485	1/4" x 4"

Flat Head Woodscrews

- "P" indicates phillips head
- 100 per box



PART NUMBER	SIZE	LENGTH	MATERIAL
1503-P	#12	1-1/2"	Brass
1504-P		1-1/2"	Steel
1505-P		2"	Brass
1531	#14	1-1/2"	Brass

All Thread Rod Coupling

- Plated steel



PART NUMBER	SIZE
1547	3/8" x 16T x 1-1/8"

Setting Tool

- Plated steel



PART NUMBER	SIZE
1552	3/8" or 1/2"



Stove Bolts

- Round head with hex nuts
- 100 bolts and nuts per box



PART NUMBER	SIZE
1635	3/16" x 3/4"
1640	1/4" x 3/4"
1641	1/4" x 1"
1642	1/4" x 1-1/4"
1643	1/4" x 1-1/2"

Drop In Concrete Anchors

- 100 per box
- Complies ICBO # 3631 RR# 24682



PART NUMBER	SIZE
1558	3/8"

Sheet Metal Screws

- Hex slotted
- 1/4" Hex head
- Plated
- 100 per box



PART NUMBER	SIZE	LENGTH
*1831-100	#7	5/8"
1817	#8	1/2"
1819		3/4"
1821		1"
1871	#10	3/4"

*#1831 Hex slotted self-drilling type

Drive Screws

- 100 per box



PART NUMBER	SIZE
1555	2" x #16

Self-Drilling Screws

- 100 per box
- Self-drilling point
- 1/4" hex head



PART NUMBER	SIZE
1830	1/2" x #8



Hex Screw and Nut Setter

- Use with 1/4" drill to drive hex sheet metal and anchor screws.
- Magnetic socket
- Heat treated
- 1/4" Drill shank



PART NUMBER	SIZE	BODY DIAMETER
1594	1/4"	7/16"
1595	5/16"	1/2"

Steel Eye Sockets

Flat and Offset

- Plated
- 3/8" N.S.T.
- 100 per box

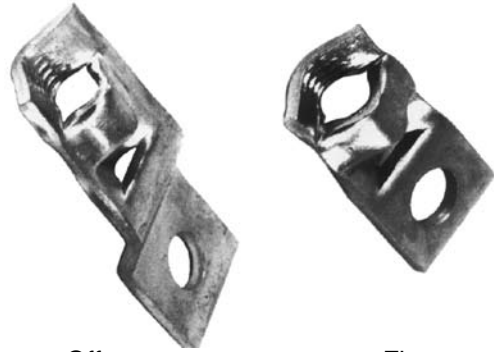

Offset
2-5/8" Length

Flat
1-7/8" Length

PART NUMBER	SIZE
1556	Flat
1557	Offset

Self-Nailing Protection

- 100 per box



PART NUMBER	SIZE	GAUGE
1628	2" x 5	20
1630		16

Made in U.S.A.

Pipe Straps

- 100 per box
- Self-drilling point
- 1/4" hex head



See price page for quantity pack

*with nails

Made in U.S.A.

Galvanized

PART NUMBER	IPS SIZE
1614-I	1/2"
1615-I	3/4"
1616-I	1"
1617-I	1-1/4"
1618-I	1-1/2"
1619-I	2"
1620	2-1/4"
1621	3"
1622	4"

1" Copper Clad Nails

PART NUMBER
1664

Copper Clad

1623*	1/2"
1624*	3/4"
1625*	1"
1626	1-1/4"



Sillcock Key

Die Cast



PART NUMBER	SIZE
1699	1/4"
1700	5/16"

Heater Furnace Loglighter Keys

Die Cast



PART NUMBER	SIZE	LENGTH
1705	5/16"	2-1/4"
1706	1/4"	10"
1707	5/16"	10"

Water Heater Earthquake Strap

Fits up to 50 gal. water heater

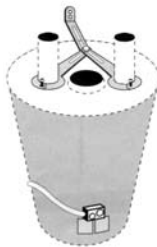

PART NUMBER
1725

Four Way Key

- Fits stopcocks, sillcocks and valves
- Sizes are 1/4" to 9/32" and 5/16" to 11/32"
- Die Cast
- Key chain loop



PART NUMBER
1701

Copper Thermocouples

All thermocouples are furnished with universal adapters

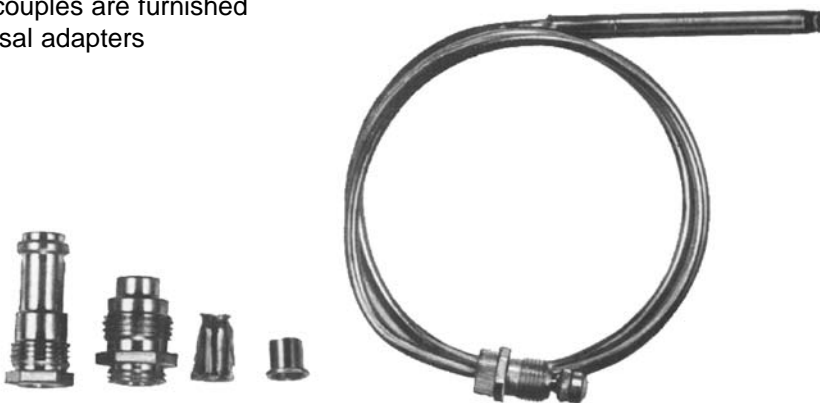

PART NUMBER	LENGTH
9500	18"
9501	24"
9502	30"
9503	36"
9504	48"

Ice Maker Hook-Up Kits

For use on refrigerators with automatic icemakers. Also use on humidifiers.



- Poly Tubing**
KIT CONTAINS
- 1. 1/4" x 25' Poly tubing
 - 1. Self-piercing needle valve
 - 1. 1/4" Compression union
 - 4. 1/4" Brass insert sleeves

Poly Tubing

PART NUMBER	SIZE
2045	Hook-Up Kit
2056-25	25' Poly Tubing ONLY



- Copper Tubing**
KIT CONTAINS
- 1. 1/4" x 25' Copper Tubing
 - 1. Self piercing needle value
 - 1. 1/4" Compression union
 - 1. 1/4" Compression male
 - 1. 1/4" 90° Compression elbow

Copper Tubing

PART NUMBER	SIZE
2049	Copper Hook-Up Kit Only
2059-25	25' Copper Tubing ONLY

Granulated Carbon Filter

Filters contain granulated carbon for taste and odor removal from municipal drinking water.

- SPECIFICATIONS:**
- Container - Polypropylene
 - Media- Activated Carbon
 - Filter/Screen - Polyestr Felt
 - Micron Size - 20
 - Flow Rate - 1 GPM @ 60 PSI
 - Life Span - 3-6 months
 - Effective Filterings - 2000 gal.
 - Temp Rating - 120° F
 - Pressure Rating - 125 PSI

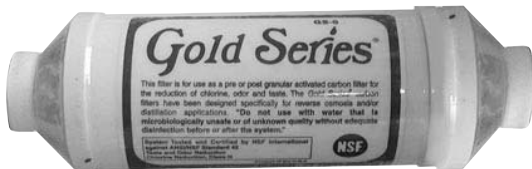

PART NUMBER	SIZE
2060	Use 1/4" Compression Fittings
2060-38	Use 3/8" Compression Fittings

Self-Piercing Needle Valve

For 3/8" To 1" Copper Tube

- KIT CONTAINS:**
- 1. Needle valve
 - 1. Saddle clamp
 - 2. Nuts
 - 2. Bolts



PART NUMBER
2162