



U.S.A. made DuraFlex®
DRAIN SNAKE CABLES
NOW AVAILABLE

Replacements for General and Ridgid

PART NUMBER	DESCRIPTION	GENERAL REPLACEMENT
1005132	3/8"x100' IW CABLE W/MALE TO FEMALE CONN	100EM2
25851	1/4"x25' CINC CABLE-EL BASIN PLUG HEAD	25HE1
25851A	5/16"x25' CINC CABLE-EL BASIN PLUG HEAD	25HE1A
25851AC	5/16"x25' CINC CABLE W/FEMALE CONN	25HE1AC
25851DDH	1/4"x25' CINC CABLE W/DOUBLE DROP HEAD	25HE1-DDH
25851DH	1/4"x25' CINC CABLE W/DROP HEAD	25HE1-DH
35852	3/8"x35' I CABLE W/FEMALE CONN	35HE2
505132	3/8"x50' IW CABLE W/MALE TO FEMALE CONN	50EM2
505133	1/2"x50' IW CABLE W/MALE TO FEMALE CONN	50EM3
50851	1/4"x50' CINC CABLE-EL BASIN PLUG HEAD	50HE1
50851A	5/16"x50' CINC CABLE-EL BASIN PLUG HEAD	50HE1A
New! 50851AC	5/16"x50' CINC CABLE FEMALE	50HE1AC
50851DH	1/4"x50' CINC CABLE W/DROP HEAD	50HE1-DH
755132	3/8"x75' IW CABLE W/MALE TO FEMALE CONN	75EM2

PART NUMBER	DESCRIPTION	RIDGID REPLACEMENT
37847	3/8"x75' IW CABLE W/MALE TO FEMALE CONN	C-32
37852	3/8"x100' IW CABLE W/MALE TO FEMALE CONN	C-33
87577	3/8"x50' IW CABLE W/MALE TO FEMALE CONN	C-31
87592	1/2"x50' IW CABLE W/MALE TO FEMALE CONN	C-44

KEY TABLE	
CINC	CABLE IN CABLE
IW	INTEGRAL WOUND
DH	DROP HEAD
DDH	DOUBLE DROP HEAD
I	INNERCORE



SHIPPED IN DURABLE CARTONS.
 CABLE ENDS INDICATED ON
 OUTSIDE OF BOX.





The History Of **Duracable** Manufacturing Company

Since 1981 **Duracable** has been serving drain cleaning professionals with the equipment they need to provide superior service to their customers high performance drain cleaning machines.

Duracable recognizes that our customer's livelihood depends on equipment performance, that's why **Duracable** stands behind its products with the industry's only two year warranty on drain cleaning machines and a 30 day warranty on cables. **Duracable** manufactures its cables from a proprietary, hard-drawn, high tensile, strength wire in a variety of diameters, lengths and flexible characteristics to fit every application.

All cable is packaged and shipped to you in a unique carton that eliminates problems caused by banding and protects the cable during the shipping process. The cable loads easily into your machine with fewer kinks, longer life and better return on your investment. We thoroughly test our cable before distribution. If the cable does not pass any of the tests, it is discarded and will not be sold. The entire shipment of wire is returned to our supplier. If the cable passes all of the tests, it is boxed and tagged for use.

Excellent Profits Are Generated With **PASCO** Drain Snake Specialty Items.



PASCO offers the plumbing trade the only complete displays of Drain Snake Specialties.

Generic versions of General, Ridgid and Marco, as well as original Gorlitz (also fits Spartan and Trojan) and Flexible Plumbertool cutter heads, augers, drop heads, blades are available on these displays. Each part is provided with easy to identified labeling. **PASCO** also offers our exclusive Gen/Rid adapter that adapts General cutters to Ridgid cables or Ridgid cutters to General cables.

The displays can be purchased with toilet and urinal augers, hand pumps, gloves and several other items that provide a plumber with the tools necessary for a drain cleaning job.

Each and every item is manufactured to the highest quality that the professional plumber requires.



GEN-RID

Drain Snake Tool Adapters

- Adapts General Heads to Ridgid Cables
- Adapts Ridgid Heads to General Cables
- Made of Tempered Tool Steel
- Comes With Ridgid Release Key (PS-A13)
- Fits 5/16", 3/8" and 1/2" cables

New!

Only Available from Pasco

PS-11

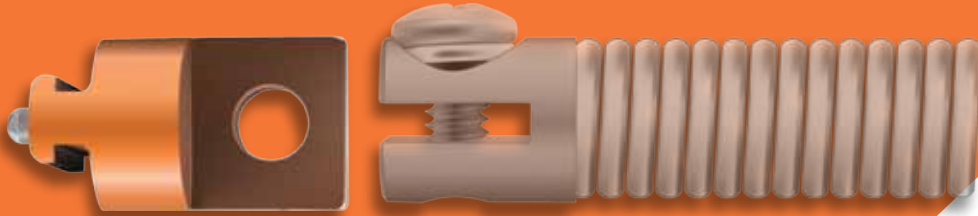

PS-12

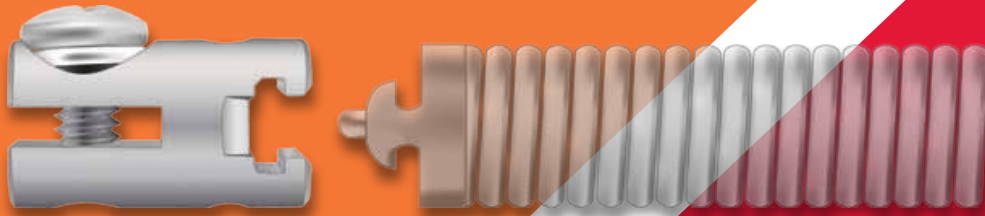

Drain Snake Tool Kit PS-23 Both Adapters



PART NUMBER	Description
PS-23	Drain Snake Tool Adapters
PS-11	Adapts Ridgid Heads to General Cables
PS-12	Adapts General Heads to Ridgid Cables



Professional Auger Bag



1. Durable design - Easy to wash out
2. Air holes to help dry
3. Keeps water + waste from dripping on the floor while exiting jobs
4. Inside pockets designed to help carry essential items
5. One closed end for easy storage
6. Holds two augers

PART NUMBER	DESCRIPTION
PS-BAG	AUGER BAG



REAL-TITE® PLUGS 
 INCORPORATED **The Original.**

The Reusable, Code-Approved, Expansion Plug That Solves ALL Your Problems.

A Tight, Dependable Seal for Virtually Any Opening

This means you can seal any opening permanently, regardless of the condition or threads.

Unique design prevents moisture from being revealed to the nut or stainless steel bolt. This allows for removal of a plug in seconds, even after long periods of time in service.

Seals 3 Ways: 3 embedded o-rings, 2 sealing ridges, and 3/16" neoprene gasket pressure expanded to create a permanent seal.

COUNTERSUNK-ABS PLASTIC TOP

- Uses a 5/32" allen wrench for installation and removal
- Designed for a "wall flush" finish

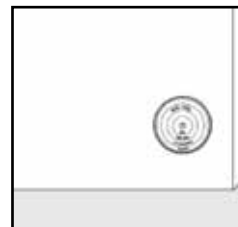

*Most Popular

PART NUMBER	DESCRIPTION
CS15	1-1/2" Real-Tite Plug
CS20	2" Real-Tite Plug
CS25	2-1/2" Real-Tite Plug
CS30	3" Real-Tite Plug
*CS35	3-1/2" Real-Tite Plug
CS40	4" Real-Tite Plug

FLOOR MOUNT-10 GAUGE STAINLESS STEEL TOP

- Uses a 5/32" allen wrench for installation and removal
- Designed for a "floor flush" finish
- Won't "Dimple" from foot or machinery traffic

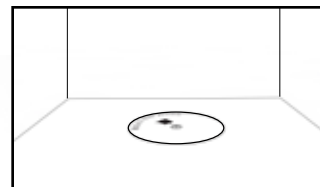

*Most Popular

PART NUMBER	DESCRIPTION
STCS15	1-1/2" SS Top Real-Tite Plug
STCS20	2" SS Top Real-Tite Plug
STCS25	2-1/2" SS Top Real-Tite Plug
STCS30	3" SS Top Real-Tite Plug
*STCS35	3-1/2" SS Top Real-Tite Plug
STCS40	4" SS Top Real-Tite Plug



**The Original Pumie®
Scouring Stick**

- Cleans where chemicals fail
- Removes stubborn lime, rust and drain snake marks from porcelain & ceramic
- Plastic handle style for hard to reach spots



PART NUMBER	HANDLE	DISPLAY PACK
3125	NO	12
3126	YES	6



Flood Control Stopper

- Helps Protect Against Basement Flooding
- Threaded Top For Use With Standpipe
- Universal Model Has A Rubber Float
- Fits 4" DWV Pipe



PART NUMBER	Description
PS-3480	Flood Control Stopper

Drain Snake Glove

Preferred by Plumbers

- PVC/NBR blend coating with PVC chips for non slip
- Chemical Resistant
- Cuffed wrist



PART NUMBER	PACK QTY
GL4100	1

**Atlas® Nitrile Tough
Gloves - Black**

Long cuff & dark grey coating

- Grips
- Won't slip when wet
- Durable
- Resists solvent cement
- Packed 12 pair



PART NUMBER
370M
370L
370XL

Drain Snake Glove

Preferred by Plumbers

- PVC/NBR blend coating with PVC chips for non slip
- Chemical Resistant
- Mid-forearm length



PART NUMBER	PACK QTY
GL4112	1

Atlas® Nitrile 380 - Blue/Black

Waffle Pattern Palm

- Lint free nylon liner
- Compressed air-infused foam nitrile coating
- Waffle pattern provides good grip in wet conditions
- Heavy duty
- Packed 12 pair



PART NUMBER
380M
380L
380XL



Generic General Style

PASCO manufactures these Drain Snake Specialties to the exacting standards of the professional plumbing industry. The products pictured on the following pages fit a variety of Drain Snake Cables used in the plumbing trade.

1-1/4" Side Cutter Blades

For 5/16" and 3/8" Cables



PART NUMBER
PS-125

Boring Auger

For 5/16" and 3/8" Cables



PART NUMBER
PS-4

1-1/2" U-Cutter

For 3/8" and 1/2" Cables



PART NUMBER
PS-15

Drop Head Boring Auger

For 5/16" and 3/8" Cables



PART NUMBER
PS-5

Cable Side Cutter Blades

For 3/8", 1/2", 5/8", and 3/4" Cables



PART NUMBER	SIZE
PS-2B	2"
PS-3B	3"
PS-4B	4"

Drop Head Fitting

For 5/16" and 3/8" Cables



PART NUMBER
PS-6

Arrowhead Starting Drill

For 5/16", 3/8", and 1/2" Cables



PART NUMBER
PS-1

Flexible Arrowhead

For 5/16" and 3/8" Cables



PART NUMBER
PS-7

Spearhead Starting Drill

For 5/8" and 3/4" Cables

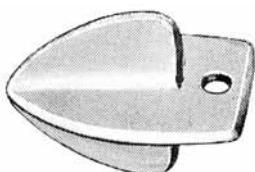

PART NUMBER
PS-3

U-Cutters

For 5/8" and 3/4" Cables



PART NUMBER	SIZE
PS-20	2"
PS-30	3"
PS-40	4"



Generic General Style

PASCO manufactures these Drain Snake Specialties to the exacting standards of the professional plumbing industry. The products pictured on the following pages fit a variety of Drain Snake Cables used in the plumbing trade.

3" Rotary Saw Blades

For 1/2", 5/8", and 3/4" Cables



PART NUMBER
PS-38

Small Corkscrew Retrieving Tool

For 3/8" and 1/2" Cables



PART NUMBER
PS-10

Cable Gripper



PART NUMBER
PS-25

All PASCO Drain Snake Specialties are packaged in clear clam shells for easy identification.

5 Piece Toolset - 3/8" Cable

- Flexible Arrowhead (PS-7)
- Boring Auger (PS-4)
- Arrowhead Starting Drill (PS-1)
- 1-1/4" Side Cutter Blades (PS-125)
- Drop Head Boring Auger (PS-5)



PART NUMBER
PS-5P

4 Piece Toolset - 3/8" Cable

- Arrowhead Starting Drill (PS-1)
- Boring Auger (PS-4)
- 1-1/2" U-Cutter (PS-15)
- 2" Cable Side Cutter Blades (PS-2B)



PART NUMBER
PS-4P



Generic Ridgid Style

PASCO manufactures these Drain Snake Specialties to the exacting standards of the professional plumbing industry. The products pictured on the following pages fit a variety of Drain Snake Cables used in the plumbing trade.

Straight Auger



PART NUMBER	CABLE	LENGTH	CONNECTOR SIZE
PS-990	3/8" & 1/2"	5"	5/8"
PS-850	1/2" & 7/8"	8"	7/8"

Double Tooth Cutter



PART NUMBER	CABLE	PIPE SIZE
PS-510	5/8" & 3/4"	2"
PS-515	5/8" & 3/4"	2-1/2"
PS-520	5/8" & 3/4"	3"

Cone Auger



PART NUMBER	CABLE	LENGTH	CONNECTOR SIZE
PS-855	1/2" & 7/8"	6"	7/8"
PS-010	3/8" & 1/2"	3"	5/8"

Spiral Cutter



PART NUMBER	CABLE	PIPE SIZE	CONNECTOR SIZE
PS-015	3/8" & 1/2"	1-1/4"	5/8"
PS-020	3/8" & 1/2"	1-1/2"	5/8"
PS-025	3/8" & 1/2"	2"	5/8"

Boring Auger



PART NUMBER	CABLE	PIPE SIZE	CONNECTOR SIZE
PS-000	3/8" & 1/2"	7/8"	5/8"
PS-995	3/8" & 1/2"	1-1/8"	5/8"

Rotary Tooth Cutter



PART NUMBER	CABLE	PIPE SIZE	CONNECTOR SIZE
PS-505	5/8" & 3/4"	3"	5/8"

Drop Head Auger



PART NUMBER	CABLE
PS-065	3/8" & 1/2"

Heavy Duty C-Grease Cutter



PART NUMBER	CABLE	SIZE	CONNECTOR SIZE
PS-812	3/8" & 1/2"	2"	5/8"
PS-817	3/8" & 1/2"	2-1/2"	5/8"
PS-822	3/8" & 1/2"	3"	5/8"

U-Grease Cutter



PART NUMBER	CABLE	SIZE	CONNECTOR SIZE
PS-837	3/8" & 1/2"	1"	5/8"
PS-005	3/8" & 1/2"	1-3/8"	5/8"

Pin Key



PART NUMBER	CABLE
PS-A13	3/8" & 5/8"



Generic Ridgid Style

PASCO manufactures these Drain Snake Specialties to the exacting standards of the professional plumbing industry. The products pictured on the following pages fit a variety of Drain Snake Cables used in the plumbing trade.

Arrowhead Grease Cutter



PART NUMBER	CABLE	SIZE	CONNECTOR SIZE
PS-030	3/8" & 1/2"	1"	5/8"
PS-035	3/8" & 1/2"	1-3/8"	5/8"
PS-040	3/8" & 1/2"	1-3/4"	5/8"

Arrowhead



PART NUMBER	CABLE	SIZE
PS-495	5/8" & 3/4"	1-3/4"

Spearhead Grease Cutter



PART NUMBER	CABLE	SIZE	CONNECTOR SIZE
PS-870	1/2"	2-1/2"	7/8"
PS-875	1/2"	3-1/2"	7/8"

Knife U-Cutter



PART NUMBER	CABLE	SIZE	CONNECTOR SIZE
PS-842	1/2"	1-1/2"	7/8"
PS-852	1/2"	2-1/2"	7/8"

Quad Cutter



PART NUMBER	CABLE	SIZE	CONNECTOR SIZE
PS-045	3/8" & 1/2"	1"	5/8"
PS-050	3/8" & 1/2"	1-3/8"	5/8"
PS-055	3/8" & 1/2"	1-3/4"	5/8"

H-Cutter



PART NUMBER	CABLE	SIZE	CONNECTOR SIZE
PS-865	1/2"	2-1/2"	7/8"

Quad Cutter



PART NUMBER	CABLE	SIZE	CONNECTOR SIZE
PS-930	1/2"	1-3/4"	7/8"
PS-935	1/2"	3"	7/8"

Arrowhead Cutter



PART NUMBER	CABLE	SIZE	CONNECTOR SIZE
PS-880	1/2"	1-3/4"	7/8"

6 Piece Toolset - 3/8" Cable

For 3/8" Cable

Contains one each:

- 1-1/8" Boring Auger (PS-995)
- 1" U- Grease Cutter (PS-837)
- 1" Arrowhead Grease Cutter (PS-030)
- 1-3/8" U-Grease Cutter (PS-005)
- 1-3/8" Arrowhead Grease Cutter (PS-035)
- Pin Key (PS-A13)

PART NUMBER
PS-240



Generic Ridgid Style



Generic Marco Style

Snap In Boring Auger

For 5/16" and 3/8" Cables



PART NUMBER
PS-5181

Snap In Boring Auger

For 3/8" and 1/2" Cables



PS-6155

PS-5199

PART NUMBER	SIZE
PS-5199	3/8" Cable
PS-6155	1/2" Cable

Snap In Cutter

For 5/16" and 3/8" Cables



PART NUMBER	SIZE
PS-5183	5/16" Cable
PS-5222	3/8" Cable

Snap In Cone Auger

For 1/2" and 5/8" Cables



PART NUMBER
PS-6166

Snap In Tub Auger

For 5/16" Cable



PART NUMBER	LENGTH
PS-5184	6"

Snap In Spring Cutter

For 1/2" and 5/8" Cables
For 1-1/2" and 2" Lines



PART NUMBER	LENGTH
PS-6177	6"



Generic Marco Style

Snap In Drop Head Boring Auger

For 5/16", 3/8", and 1/2" Cables



PART NUMBER	SIZE
PS-5182	5/16" Cable
PS-5211	3/8" Cable
PS-7166	1/2" Cable

Snap In Arrowhead

For 3/8" and 1/2" Cables



PART NUMBER
PS-7177

Snap In Quad Cutter

For 5/8" and 1/2" Cables



PART NUMBER
PS-7179

3 Piece Toolset - 3/8" Cable

- Boring Auger (PS-5199)
- Drop Head Auger (PS-5211)
- Cutter (PS-5222)



PART NUMBER
PS-5188

4 Piece Toolset - 5/16" Cable

- Boring Auger (PS-5181)
- Drop Head Auger (PS-5182)
- Cutter (PS-5183)
- Tub Auger (PS-5184)



PART NUMBER
PS-5190

3 Piece Toolset - 1/2" Cable

- Boring Auger (PS-6155)
- Drop Head Auger (PS-7166)
- Cutter (PS-7179)



PART NUMBER
PS-6205



Gorlitz Sewer & Drain

Original Manufacturer • Made in U.S.A.

Also fits Spartan

Cable End Fitting

For Blade Attachment



PART NUMBER	SIZE
E01	3/8" Cable
E03	1/2" Cable
E04	11/16" Cable

Cable Connector

Slip Joint Style



PART NUMBER	SIZE
E05	5/8" Cable
E06	11/16" Cable

Regular Chuck

For Blades K06 thru K14



*Allen Screw Only

PART NUMBER
E08
F515*

Finger Leader

Flexible Leader Guides
3/8" and 1/2" Cables thru Bends



PART NUMBER
E10

Full Circle Blades



PART NUMBER	SIZE	CABLE SIZE
K03	1-1/2" Plain	For 3/8", 13/32", & 1/2"
K03A	1-1/2" Plain-Thin	
K04	2" Plain	For 5/8", 11/16", & 3/4"
K07	2" Plain	
K10	2-1/2" Teeth	
K11	3" Teeth	

Pear Shape Blades



PART NUMBER	SIZE	CABLE SIZE
K05	3" Plain	For 3/8", 13/32", & 1/2"
K08	3" Plain	
K08A	4" Plain	For 5/8", 11/16", & 3/4"
K13	2" Teeth	
K14	3" Teeth	
K14A	4" Teeth	

Half Circle Blades



PART NUMBER	SIZE	CABLE SIZE
K01	1-1/2" Plain	For 3/8", 13/32", & 1/2"
K02	2" Plain	
K06	2" Plain	For 5/8", 11/16", & 3/4"

Heavy Duty Pear Shape Blades

For 5/8", 11/16", and 3/4" Cables
1" Wide Blades



PART NUMBER	SIZE
K15	3" Teeth
K16	4" Teeth

U-Shape Teeth Blades

For 5/8", 11/16", and 3/4" Cables



PART NUMBER	SIZE
K12	4" Teeth



Gorlitz Sewer & Drain

Original Manufacturer • Made in U.S.A.

Also fits Spartan

Grease Blade

For 5/8", 11/16", and 3/4" Cables



PART NUMBER	SIZE
K18	4"

Heavy Duty Cone Chuck

For 4" Diameter Sewer Lines

Accepts 3 Blades



PART NUMBER	DESCRIPTION
E09A	Chuck Only
K23	3" Single Knife-Teeth
K19	4" Single Knife-Teeth
K21	4" Single Knife-Coined

Cable Repair Splices

Repair 3/8" to 3/4" Cables



PART NUMBER	CABLE SIZE
S01	3/8"
S03	1/2"
S04	5/8"
S05	11/16"
S06	3/4"

Blade Holders

For 3/4" Wide Blades

Use to clean drain lines above 3"



*Fits Spartan

PART NUMBER	SIZE
E60	For Blades K06-K14
E61	For Blades K09-K12
E59*	Hex Chuck Blade Holder

Replaceable Downhead



PART NUMBER	CABLE SIZE
DHR04	3/8"
DHR05	1/2"

Spearhead



PART NUMBER	USE CONNECTOR
E22	E05 - 5/8"
	E06 - 11/16"
	E08 - Chuck
E69	E53 - 5/8"
	E54 - 11/16"
	E55 - 3/4"

11 Piece Toolset - 3/8" Cable

- One each Blades K01 thru K05
- 3 - E01 (Cable End Fitting)
- 2 - S01 (Cable Repair Splices)
- DHR04 (Replaceable Downhead)



PART NUMBER
GKIT38

11 Piece Toolset - 1/2" Cable

- One each Blades K01 thru K05
- 3 - E03 (Cable End Fitting)
- 2 - S03 (Cable Repair Splices)
- DHR05 (Replaceable Downhead)



PART NUMBER
GKIT12

Flexible Plumbertool

Original Manufacturer • Made in U.S.A.

Side Grease Cutters



PART NUMBER	CABLE	SIZE
PTF21	3/8" & 1/2"	1"
PTF22	3/8" & 1/2"	1-1/8"
PTF23	3/8" & 1/2"	1-3/8"
PTF24	3/8" & 1/2"	1-5/8"
PTF25	3/8" & 1/2"	1-3/4"
PGTF42*	5/8" & 3/4"	2"

*with adapter

Drop Head

For 3/8" and 1/2" Cables

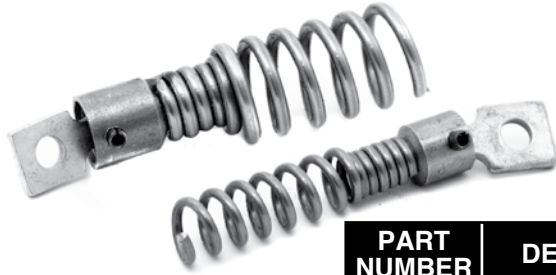

PART NUMBER	DESC.
MGSD1	Small
MGSD2	Heavy Duty

Serrated Cutter

For 3/8", 1/2", 5/8", and 3/4" Cables



PART NUMBER	SIZE
SPT3	2- 3/8"
SPT3G*	1-3/4"
SPT4	2-3/4"

*fits General

Couplings & Connectors

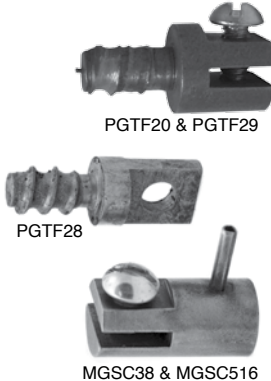

PART NUMBER	DESC.
PGTF20	3/4" Female End Coupling
PGTF28	1/2" Male End Coupling
PGTF29	1/2" Female End Coupling
MGSC38	3/8" Female End Connector
MGSC516	5/16" Female End Connector

Blade-Tool Adapter

Standard
For 3/8", 1/2", 5/8", and 3/4" Cables



PART NUMBER
MGSMBF
MGSMBFG*

*fits General

10" Retriever

For 3/8" and 1/2" Cables



PART NUMBER
PGTF67



Flexible Plumbertool

Original Manufacturer • Made in U.S.A.

Arrowhead

For 3/8" and 1/2" Cables



PART NUMBER
MGSS1

Bore Cutter

For 5/8" and 3/4" Cables



PART NUMBER	SIZE
PGTF14	2"
PGTF15	3"

Star Point Borer



*with adapter

PART NUMBER	CABLE
SPB1	3/8" & 1/2"
PGTF35*	5/8" & 3/4"

4 Piece Toolset

For 3/8" and 1/2" Cables

- Arrowhead (MGSS1)
- Star Point Borer (SPB1)
- Blade-Tool Adapter (MGSMBF)
- 1-3/8" Side Grease Cutter (PTF23)

PART NUMBER
MGS4S31



Knife Cutter

For 5/8" and 3/4" Cables



PART NUMBER	SIZE
PGTF173	3"
PGTF174	4"

5 Piece Toolset

For 3/8" and 1/2" Cables

- Small Drop Head (MGSD1)
- Arrowhead (MGSS1)
- Blade-Tool Adapter (MGSMBF)
- 1" Side Grease Cutter (PTF21)
- 1-3/8" Side Grease Cutter (PTF23)

PART NUMBER
MGSS20



Saw or Scraper

For 3/8" and 1/2" Cables



PART NUMBER	DESC.
MGDS1	Saw
MGDSS1	Scraper



Closet & Urinal Augers

Regular Head

- Professional plumber style
- Cable hold clip molded on handle
- Tempered spring steel
- Vinyl grips and bowl guard

6' model has telescoping cable feature:
press button on shaft and pull cable out

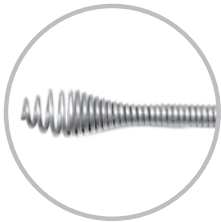

PART NUMBER	OVERALL LENGTH	DESCRIPTION
PS-3CA	3'	3/4" Guide Tube
PS-6CA	6'	1-1/8" Heavy Duty Guide Tube

Drop Head

- Professional plumber style
- Cable hold clip molded on handle
- Tempered spring steel
- Vinyl grips and bowl guard

6' model has telescoping cable feature:
press button on shaft and pull cable out

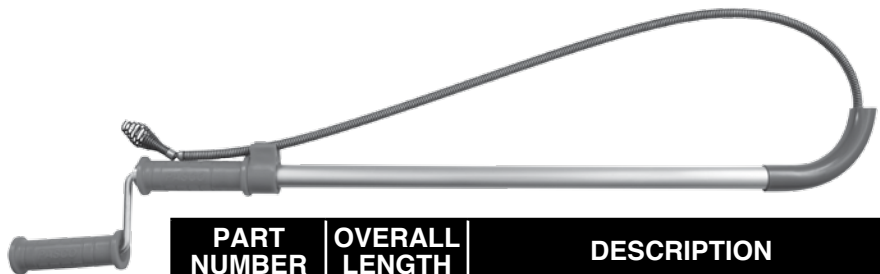

PART NUMBER	OVERALL LENGTH	DESCRIPTION
PS-3CADH	3'	3/4" Guide Tube
PS-6CADH	6'	1-1/8" Heavy Duty Guide Tube

Urinal - Regular Head

- Professional plumber style
- Cable hold clip molded on handle
- Tempered spring steel
- Vinyl grips and bowl guard

48" Telescoping Cable

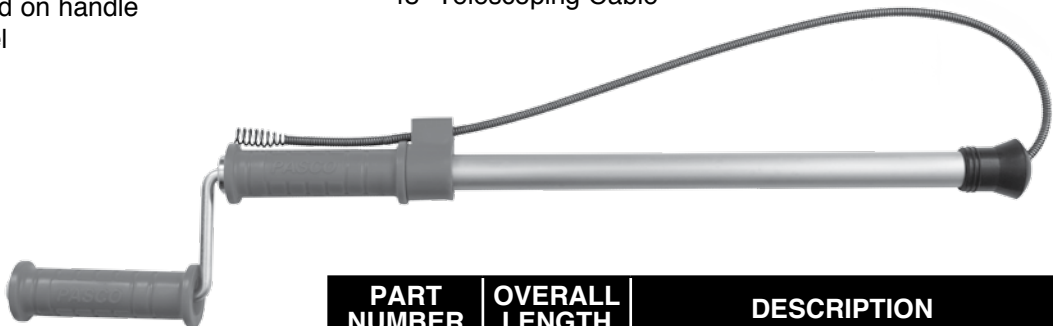

PART NUMBER	OVERALL LENGTH	DESCRIPTION
PS-4TUA	48"	1-1/8" Heavy Duty Guide Tube



Master Plumbers Force Cup

- Heavy duty
- Ribbed cup for strength
- Provides big “blast” for all stoppages
- High quality rubber
- 19” handle



PART NUMBER
4636

Heavy Duty Closet Bowl Force Cup

- Extra large for best pressure with positive seal
- Designed for all types of toilets
- High quality black rubber
- 19” handle



PART NUMBER
4637

Economy Force Cup

- High quality red rubber
- Available in 5” or 6” diameter
- 19” handle



PART NUMBER	SIZE
4640	5”
4641	6”

Hand Pumps

- Use to drain or transfer water
- Large volume of water drawn with each pull of the handle

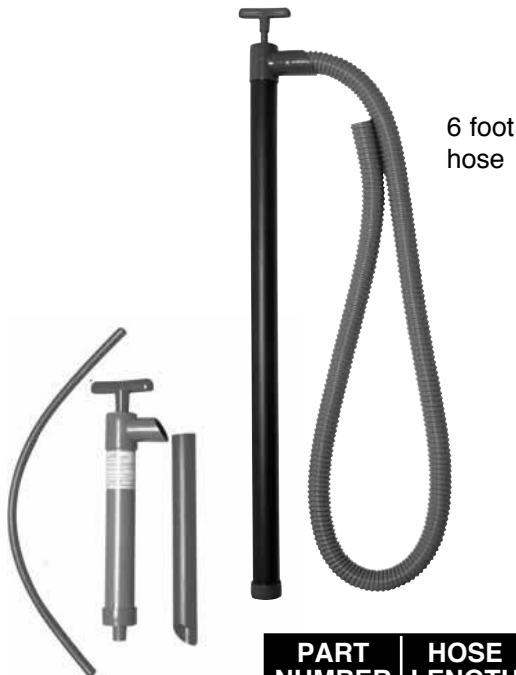

Mini pump ideal for draining traps or curved pipe

PART NUMBER	HOSE LENGTH
136PF-6	6 ft.
12-A	3 ft.

Eureka Cleanout Plug Wrench

- This unique tool fits either slotted or square countersunk cleanout plugs
- Strong, malleable iron
- Fits slotted or square

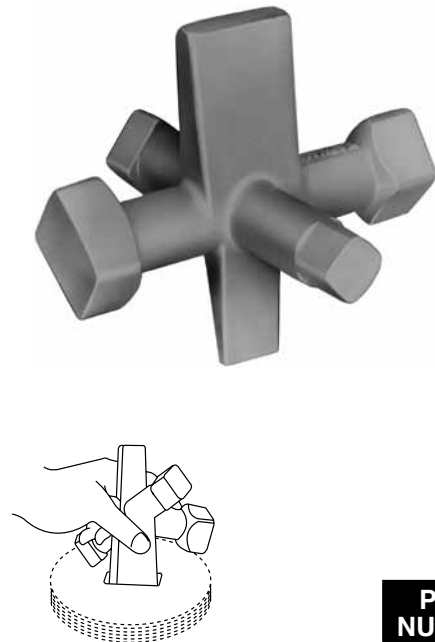

PART NUMBER
4567



GENERIC GENERAL MASTER



PART #	DESCRIPTION	QTY
PS-1	ARROWHEAD FITS 3/8"-1/2" CABLES	1
PS-10	SMALL CORKSCREW RETRIEVING TOOL	1
PS-11	ADAPTS RIDGID HEADS TO GENERAL CABLES	1
PS-12	ADAPTS GENERAL HEADS TO RIDGID CABLES	1
PS-125	1.25 SIDE CUTTER BLADE-3/8" CABLE	1
PS-15	1.5 U-CUTTER FOR 3/8" CABLE	1
PS-20	2" U-CUTTER FOR 5/8"-3/4" CABLES	1
PS-23	DRAIN SNAKE TOOL ADAPTERS	1
PS-25	CABLE GRIPPER	1
PS-2B	2" SIDE CUTTER BLADES-1/2" CABLE	1
PS-3	SPEARHEAD FITS 3/8"-1/2" CABLES	1
PS-30	3" U-CUTTER FOR 5/8"-3/4" CABLES	1
PS-38	3" ROTARY SAW BLADE	1
PS-3B	3" SIDE CUTTER BLADES-1/2" CABLES	1
PS-4	BORING AUGER-3/8" CABLE	1
PS-40	4" U-CUTTER FOR 5/8"-3/4" CABLES	1
PS-4B	4" SIDE CUTTER BLADES-1/2" CABLES	1
PS-4P	4 PIECE CUTTER SET FOR 3/8" CABLE	1
PS-5	DOWNHEAD BORING GIMLET-3/8" CABLE	1
PS-5P	5 PIECE CUTTER SET FOR 3/8" CABLE	1
PS-6	DOWNHEAD FITTING-3/8" CABLE	1
PS-7	FLEX ARROWHEAD FOR 3/8" CABLE	1
3126	PUMICE SCORING STICK WITH HANDLE	1
4567	EUREKA CLEANOUT PLUG WRENCH	1
GL4100	DRAIN SNAKE GLOVE-SHORT CUFF	1
GL4112	DRAIN SNAKE GLOVE-LONG CUFF	1
PS-BAG	AUGER BAG	1
PS-3CA	3' CLOSET AUGER-REGULAR HEAD	1
PS-6CA	6' CLOSET AUGER-REGULAR HEAD	1
PS-3CADH	3' CLOSET AUGER-DOWN HEAD	1
PS-6CADH	6' CLOSET AUGER-DOWN HEAD	1
PS-4TUA	URINAL AUGER	1

GENERIC GENERAL MINI



PART #	DESCRIPTION	QTY
PS-1	ARROWHEAD FITS 3/8"-1/2" CABLES	1
PS-10	SMALL CORKSCREW RETRIEVING TOOL	1
PS-11	ADAPTS RIDGID HEADS TO GENERAL CABLES	1
PS12	ADAPTS GENERAL HEADS TO RIDGID CABLES	1
PS-125	1.25 SIDE CUTTER BLADE-3/8" CABLE	1
PS-15	1.5 U-CUTTER FOR 3/8" CABLE	1
PS-20	2" U-CUTTER FOR 5/8"-3/4" CABLES	1
PS-23	DRAIN SNAKE TOOL ADAPTERS	1
PS-25	CABLE GRIPPER	1
PS-2B	2" SIDE CUTTER BLADES-1/2" CABLE	1
PS-3	SPEARHEAD FITS 3/8"-1/2" CABLES	1
PS-30	3" U-CUTTER FOR 5/8"-3/4" CABLES	1
PS-38	3" ROTARY SAW BLADE	1
PS-3B	3" SIDE CUTTER BLADES-1/2" CABLES	1
PS-4	BORING AUGER-3/8" CABLE	1
PS-40	4" U-CUTTER FOR 5/8"-3/4" CABLES	1
PS-4B	4" SIDE CUTTER BLADES-1/2" CABLES	1
PS-4P	4 PIECE CUTTER SET FOR 3/8" CABLE	1
PS-5	DOWNHEAD BORING GIMLET-3/8" CABLE	1
PS-5P	5 PIECE CUTTER SET FOR 3/8" CABLE	1
PS-6	DOWNHEAD FITTING-3/8" CABLE	1
PS-7	FLEX ARROWHEAD FOR 3/8" CABLE	1



GENERIC RIDGID MASTER



PART #	DESCRIPTION	QTY
PS-11	ADAPTS RIDGID HEADS TO GENERAL CABLES	1
PS-12	ADAPTS GENERAL HEADS TO RIDGID CABLES	1
PS-23	DRAIN SNAKE TOOL ADAPTERS	1
PS-990	5" STRAIGHT AUGER FOR 1/2" CABLE	1
PS-850	8" STRAIGHT AGUER FOR 1/2" CABLE	1
PS-855	5" CONE AUGER FOR 1/2" CABLE	1
PS-010	3" CONE AUGER FOR 1/2" & 3/8" CABLE	1
PS-000	7/8" BORING AUGER FOR 3/8" CABLES	1
PS-995	1-1/8" BORING AUGER FOR 3/8" CABLES	1
PS-065	3-3/4" DROP HEAD FOR 3/8" CABLES	1
PS-837	1" U-GREASE CUTTER FOR 3/8" & 1/2" CABLES	1
PS-005	1-3/8" U-GREASE CUTTER FOR 3/8" & 1/2" CABLES	1
PS-015	1-1/4" SPIRAL CUTTER FOR 3/8" & 1/2" CABLES	1
PS-020	1-1/2" SPIRAL CUTTER FOR 3/8" & 1/2" CABLES	1
PS-025	2" SPIRAL CUTTER FOR 3/8" & 1/2" CABLES	1
PS-505	3" ROTARY TOOTH CUTTER 3/8" & 1/2" CABLES	1
PS-812	2" HD C-GREASE CUTTER FOR 5/8" CABLES	1
PS-817	2-1/2" HD C-GREASE CUTTER FOR 5/8" CABLES	1
PS-822	3" HD C-GREASE CUTTER FOR 5/8" CABLES	1
PS-030	1" ARROWHEAD GREASE CUTTER FOR 3/8" & 1/2"	1
PS-035	1-3/8" ARROWHEAD GREASE CUTTER FOR 3/8" & 1/2"	1
PS-040	1-3/4" ARROWHEAD GREASE CUTTER FOR 3/8" & 1/2"	1
PS-870	2-1/2" SPEARHEAD GREASE CUTTER FOR 1/2"	1
PS-875	3-1/2" SPEARHEAD GREASE CUTTER FOR 1/2"	1
PS-045	1" QUAD CUTTER FOR 3/8" CABLES	1
PS-050	1-3/8" QUAD CUTTER FOR 3/8" & 1/2" CABLES	1
PS-055	1-3/4" QUAD CUTTER FOR 3/8" & 1/2" CABLES	1
PS-930	1-3/4" QUAD CUTTER FOR 1/2" CABLES	1
PS-935	3" QUAD CUTTER FOR 1/2" CABLES	1
PS-880	1-3/4" SPADE CUTTER FOR 1/2" CABLES	1
PS-842	1-1/2" KNIFE U-CUTTER FOR 1/2" CABLES	1
PS-852	2-1/2" KNIFE U-CUTTER FOR 1/2" CABLES	1
PS-865	2-1/2" H-CUTTER FOR 1/2" CABLES	1
PS-240	6 PIECE CUTTER KIT FOR 1/2" CABLES	1
PS-A13	PIN KEY FOR RIDGID CABLE	1
PS-6CA	6' CLOSET AUGER-REGULAR HEAD	1
PS-3CA	3' CLOSET AUGER-REGULAR HEAD	1
PS-3CADH	3' CLOSET AUGER-DOWN HEAD	1
PS-6CADH	6' CLOSET AUGER-DOWN HEAD	1
GL4100	DRAIN SNAKE GLOVE-SHORT CUFF	1
GL4112	DRAIN SNAKE GLVOE-LONG CUFF	1
3126	PUMICE SCORING STICK WITH HANDLE	1
PS-BAG	AUGER BAG	1
PS-4TUA	URINAL AUGER	1

GENERIC RIDGID MINI



PART #	DESCRIPTION	QTY
PS-11	ADAPTS RIDGID HEADS TO GENERAL CABLES	1
PS-12	ADAPTS GENERAL HEADS TO RIDGID CABLES	1
PS-23	DRAIN SNAKE TOOL ADAPTERS	1
PS-990	5" STRAIGHT AUGER FOR 1/2" CABLE	1
PS-850	8" STRAIGHT AGUER FOR 1/2" CABLE	1
PS-010	3" CONE AUGER FOR 1/2" & 3/8" CABLE	1
PS-000	7/8" BORING AUGER FOR 3/8" CABLES	1
PS-995	1-1/8" BORING AUGER FOR 3/8" CABLES	1
PS-837	1" U-GREASE CUTTER FOR 3/8" & 1/2" CABLES	1
PS-005	1-3/8" U-GREASE CUTTER FOR 3/8" & 1/2" CABLES	1
PS-030	1" ARROWHEAD GREASE CUTTER FOR 3/8" & 1/2"	1
PS-035	1-3/8" ARROWHEAD GREASE CUTTER FOR 3/8" & 1/2"	1
PS-045	1" QUAD CUTTER FOR 3/8" CABLES	1
PS-930	1-3/4" QUAD CUTTER FOR 1/2" CABLES	1
PS-880	1-3/4" SPADE CUTTER FOR 1/2" CABLES	1
PS-240	6 PIECE CUTTER KIT FOR 1/2" CABLES	1
PS-A13	PIN KEY FOR RIDGID CABLE	1



GENERIC GENERAL & RIDGID MASTER



PART #	DESCRIPTION	QTY
PS-11	ADAPTS RIDGID HEADS TO GENERAL CABLES	1
PS-12	ADAPTS GENERAL HEADS TO RIDGID CABLES	1
PS-125	1.25 SIDE CUTTER BLADE-3/8" CABLE	1
PS-15	1.5 CUTTER FOR 3/8" CABLE	1
PS-2B	2" SIDE CUTTER BLADES-1/2" CABLE	1
PS-20	2" U-CUTTER FOR 5/8"-3/4" CABLES	1
PS-23	DRAIN SNAKE TOOL ADAPTERS	1
PS-3B	3" SIDE CUTTER BLADES-1/2" CABLES	1
PS-30	3" U-CUTTER FOR 5/8"-3/4" CABLES	1
PS-4B	4" SIDE CUTTER BLADES-1/2" CABLES	1
PS-40	4" U-CUTTER FOR 5/8"-3/4" CABLES	1
PS-1	ARROWHEAD FITS 3/8"-1/2" CABLES	1
PS-4	BORING AUGER-3/8" CABLE	1
PS-5	DOWNHEAD BORING GIMLET-3/8" CABLE	1
PS-6	DOWNHEAD FITTING-3/8" CABLE	1
PS-7	FLEX ARROWHEAD FOR 3/8" CABLE	1
PS-3	SPEARHEAD FITS 3/8"-1/2" CABLES	1
PS-38	3" ROTARY SAW BLADE	1
PS-5P	5 PIECE CUTTER SET FOR 3/8" CABLE	1
PS-4P	4 PIECE CUTTER SET FOR 3/8" CABLE	1
PS-10	SMALL CORKSCREW RETRIEVING TOOL	1
PS-990	5" STARIGHT AUGER FOR 1/2" CABLE	1
PS-850	8" STRAIGHT AUGER FOR 1/2" CABLE	1
PS-010	3" CONE AUGER FOR 3/8" & 1/2" CABLES	1
PS-000	7/8" BORING AUGER FOR 3/8" CABLES	1
PS-995	1-1/8" BORING AUGER FOR 3/8" CABLES	1
PS-837	1" U-GREASE CUTTER FOR 3/8" & 1/2" CABLES	1
PS-005	1-3/8" U-GREASE CUTTER FOR 3/8" & 1/2" CABLES	1
PS-030	1" ARROWHEAD GREASE CUTTER FOR 3/8" & 1/2" CABLES	1
PS-035	1-3/8" ARROWHEAD GREASE CUTTER FOR 3/8" & 1/2" CABLES	1
PS-045	1" QUAD CUTTER FOR 3/8" & 1/2" CABLES	1
PS-930	1-3/4" QUAD CUTTER FOR 1/2" CABLES	1
PS-880	1-3/4" SPADE CUTTER FOR 1/2" CABLES	1
PS-240	6 PIECE CUTTER KIT FOR 3/8" CABLES	1
PS-A13	PIN KEY FOR RIDGID CABLE	1
PS-3CA	3' CLOSET AUGER-REGULAR HEAD	1
PS-3CADH	3' CLOSET AUGER-DOWNHEAD	1
PS-6CA	6' CLOSET AUGER-REGULAR HEAD	1
PS-6CADH	6' CLOSET AUGER-DOWNHEAD	1
GL4100	DRAIN SNAKE GLOVE-SHORT CUFF	1
3126	PUMICE SCORING STICK WITH HANDLE	1
GL4112	DRAIN SNAKE GLOVE-LONG CUFF	1
4567	EUREKA CLEANOUT PLUG WRENCH	1
PS-BAG	AUGER BAG	1

GENERIC GENERAL & RIDGID MINI



PART #	DESCRIPTION	QTY
PS-11	ADAPTS RIDGID HEADS TO GENERAL CABLES	1
PS-12	ADAPTS GENERAL HEADS TO RIDGID CABLES	1
PS-125	1.25 SIDE CUTTER BLADE-3/8" CABLE	1
PS-15	1.5 CUTTER FOR 3/8" CABLE	1
PS-2B	2" SIDE CUTTER BLADES-1/2" CABLE	1
PS-20	2" U-CUTTER FOR 5/8"-3/4" CABLES	1
PS-23	DRAIN SNAKE TOOL ADAPTERS	1
PS-3B	3" SIDE CUTTER BLADES-1/2" CABLES	1
PS-30	3" U-CUTTER FOR 5/8"-3/4" CABLES	1
PS-4B	4" SIDE CUTTER BLADES-1/2" CABLES	1
PS-40	4" U-CUTTER FOR 5/8"-3/4" CABLES	1
PS-1	ARROWHEAD FITS 3/8"-1/2" CABLES	1
PS-4	BORING AUGER-3/8" CABLE	1
PS-5	DOWNHEAD BORING GIMLET-3/8" CABLE	1
PS-6	DOWNHEAD FITTING-3/8" CABLE	1
PS-7	FLEX ARROWHEAD FOR 3/8" CABLE	1
PS-3	SPEARHEAD FITS 3/8"-1/2" CABLES	1
PS-38	3" ROTARY SAW BLADE	1
PS-5P	5 PIECE CUTTER SET FOR 3/8" CABLE	1
PS-4P	4 PIECE CUTTER SET FOR 3/8" CABLE	1
PS-10	SMALL CORKSCREW RETRIEVING TOOL	1
PS-990	5" STARIGHT AUGER FOR 1/2" CABLE	1
PS-850	8" STRAIGHT AUGER FOR 1/2" CABLE	1
PS-010	3" CONE AUGER FOR 3/8" & 1/2" CABLES	1
PS-000	7/8" BORING AUGER FOR 3/8" CABLES	1
PS-995	1-1/8" BORING AUGER FOR 3/8" CABLES	1
PS-837	1" U-GREASE CUTTER FOR 3/8" & 1/2" CABLES	1
PS-005	1-3/8" U-GREASE CUTTER FOR 3/8" & 1/2" CABLES	1
PS-030	1" ARROWHEAD GREASE CUTTER FOR 3/8" & 1/2" CABLES	1
PS-035	1-3/8" ARROWHEAD GREASE CUTTER FOR 3/8" & 1/2" CABLES	1
PS-045	1" QUAD CUTTER FOR 3/8" & 1/2" CABLES	1
PS-930	1-3/4" QUAD CUTTER FOR 1/2" CABLES	1
PS-880	1-3/4" SPADE CUTTER FOR 1/2" CABLES	1
PS-240	6 PIECE CUTTER KIT FOR 3/8" CABLES	1
PS-A13	PIN KEY FOR RIDGID CABLE	1



Drain Snake Specialties

GORLITZ MINI



PART #	DESCRIPTION	QTY
E01	3/8" CABLE END FITTING	1
E03	1/2" CABLE END FITTING	1
E04	11/16" CABLE END FITTING	1
E08	CHUCK FOR BLADES F06 THRU K14	1
E05	SJ CABLE CONNECTOR 5/8" THRU 3/4"	1
E06	SJ CABLE CONNECTOR -11/16"	1
E10	FLEX LEADER GUIDE 3/8" - 1/2" CABLES	1
F515*	ALLEN SCREW FOR CHUCK	1
K03	PLAIN 1-1/2" FULL CIRCLE KNIFE BLADE 3/8" - 1/2" CABLES	1
K03A	PLAIN 1-1/2" FULL CIRCLE THIN BLADE 3/8" - 1/2" CABLES	1
K04	PLAIN 2" FULL CIRCLE KNIFE BLADE 3/8" - 1/2" CABLES	1
K07	COINED 2" FULL CIRCLE KNIFE BLADE 3/8" - 1/2" CABLES	1
K10	TEETH 2-1/2" FULL CIRCLE BLADE 3/8" - 1/2" CABLES	1
K11	TEETH 2" FULL CIRCLE BLADE 3/8" - 1/2" CABLES	1
K12	TEETH 4" U-SHAPE KNIFE BLADE 5/8" - 3/4" CABLES	1
K05	PLAIN 3" PEAR SHAPE KNIFE BLADE 3/8" - 1/2" CABLES	1
K08	COINED 3" PEAR SHAPE KNIFE BLADE 3/8" - 1/2" CABLES	1
K08A	PLAIN 4" PEAR SHAPE KNIFE BLADE 3/8" - 1/2" CABLES	1
K13	TEETH 2" PEAR SHAPE KNIFE BLADE 3/8" - 1/2" CABLES	1
K14	TEETH 3" PEAR SHAPE KNIFE BLADE 3/8" - 1/2" CABLES	1
K14A	TEETH 4" PEAR SHAPE KNIFE BLADE 3/8" - 1/2" CABLES	1
K15	HD TEETH 3" PEAR SHAPE KNIFE BLADE 5/8" - 3/4" CABLES	1
K16	HD TEETH 4" PEAR SHAPE KNIFE BLADE 5/8" - 3/4" CABLES	1
K18	GREASE KNIFE BLADE 5/8" - 3/4" CABLES	1
E09A	HEAVY DUTY CONE CHUCK	1
K23	4" COINED KNIFE BLADE FOR E09 CHUCK	1
K19	4" TEETH SINGLE KNIFE BLADE FOR E09 CHUCK	1
K21	3" TEETH KNIFE BLADE FOR E09 CHUCK	1
E60	3/4" BLADE HOLDER K06 THRU K14	1
E61	3/4" BLADE HOLDER K06 THRU K12 ABOVE 3" LINES	1
E59*	HEX CHUCK BLADE HOLDER	1
S01	3/8" CABLE REPAIR SPLICE	1
S03	1/2" CABLE REPAIR SPLICE	1
S04	5/8" CABLE REPAIR SPLICE	1
S05	11/16" CABLE REPAIR SPLICE	1
S06	3/4" CABLE REPAIR SPLICE	1
DHR04	REPLACEABLE DOWNHEAD- 3/8" CABLE	1
DHR05	REPLACEABLE DOWNHEAD- 1/2" CABLE	1
E22	SPEARHEAD	1
E69	MALE SPEAR HEAD ASSEMBLY	1
GKIT38	11 PIECE TOOL SET- GORLITZ 3/8" CABLE	1
GKIT12	11 PIECE TOOL SET- GORLITZ 1/2" CABLE	1

GENERIC MARCO MINI



PART #	DESCRIPTION	QTY
PS-5181	SNAP IN BORING AUGER FOR 5/16" CABLE	1
PS-5183	SNAP IN CUTTER FOR 5/16" CABLE	1
PS-5222	SNAP IN CUTTER FOR 3/8" CABLE	1
PS-5199	SNAP IN BORING AUGER FOR 3/8" CABLE	1
PS-6155	SNAP IN BORING AUGER FOR 1/2" CABLE	1
PS-5184	SNAP IN TUB AUGER FOR 5/16" CABLE	1
PS-6177	SPRING CUTTER 1-1/2" - 2 LINES 1/2" - 5/8" CABLES	1
PS-5182	SNAP IN DROP HEAD AUGER FOR 5/16" CABLES	1
PS-5211	SNAP IN DROP HEAD AUGER FOR 3/8" CABLES	1
PS-7166	SNAP IN DROP HEAD AUGER FOR 1/2" CABLES	1
PS-7179	SNAP IN QUAD CUTTER FOR 1/2" - 5/8" CABLES	1
PS-7177	SNAP IN ARROWHEAD FOR 3/8" AND 1/2" CABLES	1
PS-5188	3 PIECE TOOLSET FOR 3/8" CABLES	1
PS-6205	3 PIECE TOOLSET FOR 1/2" CABLES	1
PS-5190	4 PIECE TOOLSET FOR 5/16" CABLES	1
PS-6166	SNAP IN CONE AUGER	1