

LYNCAR'S NEW PRODUCTS

			
<p>URINAL SCREENS page# A-16</p>	<p>FLUSH VALVE PARTS page# A-23 TO A-27</p>	<p>P.O. PLUGS, CLICK TOP page# B-12</p>	<p>ABS W&O KITS page# B-13</p>
			
<p>AM/STD TANK LEVERS page# C-5</p>	<p>KOHLER TANK LEVERS page# C-7</p>	<p>FLUSH VALVES page# C-18</p>	<p>LYNCAR FILL VALVE page# C-23</p>
			
<p>REINFORCED WAX RING page# C-27</p>	<p>TOILET & FLOOR REPAIR PLATES page# C-29 TO C-30</p>	<p>DANFOSS TEMPRESS page# D-8</p>	<p>DELTA HANDLES page# D-11</p>
			
<p>FIT ALL DECORATIVE HANDLE page# D-17</p>	<p>MIXET LEVER HANDLE page# A-23 TO A-27</p>	<p>WALTEC HANDLE page# D-37</p>	<p>SHOWER HEADS page# E-1</p>
			
<p>WATERFALL SPOUT page# E-11</p>	<p>SHOWER HOOK UP KITS page# E-15</p>	<p>SHOWER TRIM KITS FOR MOEN/DELTA page# E-17</p>	<p>WASHING MACHINE SUPPLY LINES page# F-3</p>

NEW

The Best Plumbing Specialties. One Source.

LYNCAR'S NEW PRODUCTS



QUARTER TURN 3 WAY VALVES
page# F-7



SINK STRAINERS
page# F-19



ADAPTERS PEX
page# G-6



PEX CLAMPS
page# G-11



PEX VALVES
page# G-14



TEFLON TAPE ORANGE
page# H-8



NITRILE GLOVES
page# H-9



X-SEAL 3C AF CAULKING COMPOUND
page# H-15



FLOW CLEAN DESCALER
page# H-19



TRANSITION COUPLINGS
page# J-2



EASY TEE & ELBOWS
page# J-3



SOCKET COUPLINGS
page# J-4



QUARTER TURN VALVES
page# J-8



BRASS WYE SHUT OFF VALVE
page# J-10



SUMP PUMP CHECK VALVE
page# J-18



ACCESS PANELS SNAP
page# J-23



MIL 3 PEX TOOLS
page# L-3



NEW PLUMBERS TOOLS
page# L-19 TO L-20



MAXPOWER TOOLS
page# M-15



CAULKING TOOLS
page# M-24

FAuCEt - COMMERCIAL

Institutional Quality - specification Grade Contemporary design - Individually Pressure tested

FAuCEt - WALL MOuNt - HEAvy duty - 8" CENT RES



- Chrome plated brass
- 1/2" FIP inlets
- Twin seal chrome plated brass tubular swing spout
- 55/64" female water saver aerator
- Colour coded handles
- Adjusts 7-1/2" to 8-1/2"
- Full flow with a quarter turn of the handle
- Replacement handles & cartridges available (**see page A-8**)
- For adjustable coupling see **part#33352** below
- cUPC approved

PART #	d EsCRIPt ION
33006	6" spout length, adjusts 7-1/2" to 8-1/2"
33008	8" spout length, adjusts 7-1/2" to 8-1/2"
33010	10" spout length, adjusts 7-1/2" to 8-1/2"
33012	12" spout length, adjusts 7-1/2" to 8-1/2"
33014	14" spout length, adjusts 7-1/2" to 8-1/2"
33027	Cold cartridge
33028	Hot cartridge

FAuCEt - WALL MOuNt - MEdIuM duty - 8" CENT RES



- Chrome plated brass
- 1/2" FIP inlets
- Twin seal chrome plated brass tubular swing spout
- 55/64" female water saver aerator
- Colour coded handles
- Adjusts 7-1/2" to 8-1/2"
- Replacement handles & cartridges available (**see page A-8**)
- For adjustable coupling see **part#33352** below
- cUPC approved

PART #	d EsCRIPt ION
33308	8" spout length, adjusts 7-1/2" to 8-1/2"
33310	10" spout length, adjusts 7-1/2" to 8-1/2"
33312	12" spout length, adjusts 7-1/2" to 8-1/2"
33314	14" spout length, adjusts 7-1/2" to 8-1/2"
33020	Cold cartridge
33021	Hot cartridge

COuPLING - FEMALE suPPLy INLEt



part#33352

part#33350

- Chrome plated brass
- 1/2" FIP inlets
- **Part#33350 and part#33352** fit heavy duty wall mount faucets
- **Part#33351** fits moderate duty wall mount faucets

PART #	FIt s	Adjus t s
33350	Heavy duty	7-1/2" to 8-1/2"
33351	Medium duty	7-1/2" to 8-1/2"
33352	Heavy duty	4-1/2" to 12-1/2" with stops

FAuCEt - COMMERCIAL dECK MOuNt

FAuCEt - dECK MOuNt - HEAvy duty - 4" CENT REs



- Chrome plated brass
- 1/2" FIP inlets
- Satin finished brass water ways
- 55/64" female water saver aerator
- Twin seal chrome plated brass tubular swing spout
- Replacement handles & cartridges available (see page A-8)

PART #	dEsCRIPt ION
33105	6" spout length
33106	12" spout length

MEdIuM duty dECK MOuNt FAuCEt - 4" CENT REs



- Same features as above model but a lighter pattern style and plain brass water ways

PART #	dEsCRIPt ION	APPROvAl
33151	6" gooseneck spout length	cUPC
33152	6" spout length	cUPC
33153	8" spout length	cUPC
33154	10" spout length	cUPC
33155	12" spout length	cUPC
33156	14" spout length	cUPC
33160	Replacement handles	-
33322	Cold cartridge	-
33323	Hot cartridge	-

MEdIuM duty WALL MOuNt FAuCEt - 4" CENT REs



- Same features as above models but a lighter pattern style and plain brass water ways

PART #	dEsCRIPt ION	APPROvAl
33161	6" gooseneck spout length	cUPC
33162	6" spout length	cUPC
33163	8" spout length	cUPC
33164	10" spout length	cUPC
33165	12" spout length	cUPC
33166	14" spout length	cUPC
33160	Replacement handles	-
33322	Cold cartridge	-
33323	Hot cartridge	-

FAuCEt - sPECIAL dUTy COMMERCIAL

sERvICE sINK FAuCEt - 8" CENTRES & 8" sPOut



- Built in screwdriver stops
- Integral check stems
- 1/2" FIP inlets
- Rough chrome plated brass
- 3/4" male hose thread on spout
- Chrome plated brass hinged wall support
- 7-1/2" to 8-1/2" wall centres
- 12" wall bracket
- cUPC approved



PART #	dEsCRIPt ION
33110	1/2" FIP inlets
33027	Cold cartridge
33028	Hot cartridge

sERvICE sINK FAuCEt - 8" CENTRES & 2-1/2" sPOut



- Built in screwdriver stops
- Integral check stems
- 1/2" FIP inlets
- Rough chrome plated brass
- 3/4" male hose thread on spout
- 7-1/2" to 8-1/2" wall centres
- 12" wall bracket
- cUPC approved



PART #	dEsCRIPt ION
33109	1/2" FIP inlets
33027	Cold cartridge
33028	Hot cartridge

FAuCEt - dECK MOuNt PANT Ry

Dual Or Single Handle



part#33111



part#33113

- 1/2" FIP inlets
- Chrome plated brass
- 1/4" tailpieces on dual handle model
- Cold handle only on single lever, 1/2" FIP inlet
- 55"/64" female water saver aerator



part#33115



part#33117

PART #	dEsCRIPt ION
33111	Hot & cold
33113	Cold only
33115	Hot & cold
33117	Cold only

FAUCET - SPECIAL duty COMMERCIAL

FAUCET - WALL MOUNT - 8" CENTRES



- Comes with blade style handles
- With 10" swing gooseneck spout
- 1/2" FIP inlets
- Chrome plated brass
- 55"/64" female water saver aerator
- Twin seal chrome plated brass tubular swing gooseneck spout

PART #	DESCRIPTION
33190	7-1/2" to 8-1/2"
33194	4-1/2" to 12-1/2" with stops
33027	Cold cartridge
33028	Hot cartridge

HEAVY duty DECK MOUNT FAUCET - 4" CENTRES



- 1/2" FIP inlets
- Chrome plated brass
- 55"/64" female water saver aerator
- Twin seal chrome plated brass tubular swing spout

PART #	DESCRIPTION
33107	6" spout length
33108	12" spout length
33027	Cold cartridge
33028	Hot cartridge

PRE-RINSE ASSEMBLIES - COMMERCIAL

Chrome Plated Brass - Built For Rugged use.

PRE-RINSE - WALL MOUNT 8" CENTRES



Riser shortened for photo

- Available with either standard 7-1/2" to 8-1/2" adjustable female supply inlet couplings, or with 4-1/2" to 12-1/2" female supply inlet couplings with stops
- 1/2" FIP inlets
- 3/8" IPS x 24" chrome plated brass riser
- 44" stainless steel hose
- 12" wall bracket
- Food service grade

PART #	DESCRIPTION
33013	Wall mount 8" centres

PRE-RINSE - DECK MOUNT - SINGLE HANDLE



Riser shortened for photo

- Chrome plated brass
- Built for rugged use
- Fits decks up to 1-1/4" thick
- 1/2" IPS inlet with 1/4" IPS tailpiece nipple
- 3/8" IPS x 24" chrome plated brass riser
- 44" stainless steel hose
- 12" wall bracket
- Food service grade

PART #	DESCRIPTION
33100	Single handle

PRE-RINSE - DECK MOUNT



Riser shortened for photo

- Fits decks up to 1-1/4" thick
- 1/2" MIP inlets
- 1/4" IPS tailpiece nipples
- 3/8" IPS x 24" chrome plated brass riser
- 44" stainless steel hose
- 12" wall bracket
- Food service grade
- Single hole mount

PART #	DESCRIPTION
33612	Pre-rinse deck mount

PRE-RINSE - DECK MOUNT - 8" CENTRES



Riser shortened for photo

- 1/2" FIP inlets
- 3/8" IPS x 24" chrome plated brass riser
- 44" stainless steel hose
- 12" wall bracket
- Food service grade
- Chrome plated brass

PART #	DESCRIPTION
33003	1/2" FIP inlets

PRE - RINsE sPRAY AssEMBLy - PARTs

PRE-RINsE - Add ON FAuCET



- Connects to 3/8" pre-rinse riser
- Chrome plated brass
- 3/8" x 2-3/4" MIP inlet
- Spout with aerator
- With hot or cold colour codes
- Fits all manufacturers

PART #	dEsCRIPt ION
33614	6" long spout
33615	12" long spout

HOsE - PRE-RINsE



- Flexible stainless steel
- Food grade inner hose withstands continuous working temperature

PART #	dEsCRIPt ION
33044	44" long
33060	60" long
33072	72" long

PRE-RINsE - sPRAY



REPLACES T & S

- Chrome plated brass
- High impact plastic handle
- Connects directly to hose
- High pressure wash
- Positive shut off
- Stay ring included
- For replacement cartridge please see **page A-7**

PART #	dEsCRIPt ION
33018	Complete
33020	Bumper ring
33021	Spray face
33030	Replacement shaft with male x female IPS

PRE - RINSE sPRAY AssEMBLy - PARTs

CARt RIdGE - PRE-RINSE sPRAY



- Chrome plated brass
- Replacement cartridge for **part#33018 (page A-6)** pre-rinse spray
- Also fits T&S BRASS models

PART #	dEsCRIPt ION
33019	Chrome plated brass

PRE-RINSE PARTs



- 1-1/2" L sPRING**
- Shortened for photo
 - Chrome

- COuPLING FOR sPRING**
- 3/8" x 3/8" x 3" long

- RIser NIPPLE**
- 3/8" x 24"

- WALL BRACKEt FOR RIser**
- C.P. brass
 - 12" long

- RIserHOOK**
- C.P. brass

PART #	dEsCRIPt ION
33022	L-Spring 1-1/2" diameter
33023	Spring coupling
33024	3/8" x 24" C.P. riser nipple
33025	12" wall bracket fits 3/8" riser
33026	3/8" riser hook

REBuILd HANdLE FOR t&s BRASS



- Rebuild ETERNA handle assembly
- Also will fit others including LynCar models
- OEM ref#02713-40

PART #	dEsCRIPt ION
33325	Rebuild handle for T&S BRASS

COMMERCIAL FAUCET REPLACEMENT PARTS

sWING sPOut



- Twin seal
- Tubular
- Chrome plated brass
- 55/64" female water saver aerator

PART # **dEsCRIPt ION**

33806	Spout - 6"
33808	Spout - 8"
33810	Spout - 10"
33812	Spout - 12"
33814	Spout - 14"
33816	Spout - 16"
33818	Spout - 18"

stEM - REPLACEMENT



- For heavy duty style faucets

PART # **dEsCRIPt ION**

33027	Heavy duty - Cold
33028	Heavy duty - Hot
33031	Heavy duty - Seat 5/8" x 27 TPI

sPOut - GOOsENECK - HEAVY duty



- Twin seal
- Tubular chrome plated brass
- 55/64" female water saver aerator

PART # **dEsCRIPt ION**

33831	Gooseneck spout - 6"
33832	Gooseneck spout - 9"
33833	Gooseneck spout - 12"

stEM - REPLACEMENT



- For medium duty style faucets

PART # **dEsCRIPt ION**

33320	8" centre faucet - Cold
33321	8" centre faucet - Hot
33322	4" centre faucet - Cold
33323	4" centre faucet - Hot

sPOuts - dOuBLE sWING



- Twin seal
- Tubular
- Chrome plated brass
- 55/64" female water saver aerator

PART # **dEsCRIPt ION**

33850	Spout - 18"
--------------	-------------

HANDLE - REPLACEMENT



- Hot / cold pair
- 20 spline

PART # **dEsCRIPt ION**

33029	HD - hot / cold - lever
--------------	-------------------------

FAUCet - WALL MOuNt HEAVY duty sINGLE HANDLE



- Swing style
- Pot filler
- Cold water only
- Chrome plated brass
- Twin seal tubular spout
- 18" overall length

PART # **dEsCRIPt ION**

33112	1/2" MPT inlet, spout - 18"
--------------	-----------------------------

HANDLE - BLAdE stYLE



- Hot / cold pair
- 20 spline

PART # **sIZE**

33104	4" hot / cold
33103	6" hot / cold

LEVER AND tWIST COMMERCIAL sINK dRAIN

dRAIN - LEVER HANDLE WItHOut OvERFLOW



- Sink opening: 3-1/2"
- Utilize a 4-1/2" strainer flange
- Nickel plated brass body
- Stainless steel handle
- Stainless steel strainer
- Nickel plated brass stopper
- Replaces FRANKLIN, KLEIN, CHICAGO FAUCET, T&S BRASS

PART #	dEsCRIPt ION
33122	1-1/2" drain connection
33123	2" drain connection

dRAIN - LEVER HANDLE W/ 1-1/4" OvERFLOW Out Let



- Sink opening: 3-1/2"
- Utilize a 4-1/2" strainer flange
- Nickel plated brass body
- Stainless steel handle
- Stainless steel strainer
- Nickel plated brass stopper
- Replaces FRANKLIN, KLEIN, CHICAGO FAUCET, T&S BRASS

PART #	dEsCRIPt ION
33131	1-1/2" drain connection
33125	2" drain connection

dRAIN - tWist LEVER HANDLE WItHOut OvERFLOW



- Sink opening: 3-1/2"
- Utilize a 4-1/2" strainer flange
- Nickel plated brass body
- Stainless steel handle
- Stainless steel strainer
- Nickel plated brass stopper
- Replaces FRANKLIN, KLEIN, CHICAGO FAUCET, T&S BRASS

PART #	dEsCRIPt ION
33126	1-1/2" drain connection
33127	2" drain connection

dRAIN - tWist LEVER HANDLE W/ 1-1/4" OvERFLOW Out Let



- Sink opening: 3-1/2"
- Utilize a 4-1/2" strainer flange
- Nickel plated brass body
- Stainless steel handle
- Stainless steel strainer
- Nickel plated brass stopper
- Replaces FRANKLIN, KLEIN, CHICAGO FAUCET, T&S BRASS

PART #	dEsCRIPt ION
33145	1-1/2" drain connection
33146	2" drain connection

PARTs FOR LEVER AND tWIST dRAINS

LEVER AND tWIST dRAIN PARTs



part#33139

part#33138

part#33136

part#33133

part#33140

part#33143

- Handles and strainer are stainless steel
- Drain body and stopper are nickel plated brass

PART	d EsCRIPt ION
33133	Lever handle
33136	3-1/2" strainer flange
33138	3-1/2" strainer
33139	Stopper with o-ring
33140	Twist handle
33143	2" x 1-1/2" slip joint drain reducer bushing
33150	Lever drain washer repair kit (not pictured)

tRAP - CAst IRON stANDARd Adjust ABLE



- Enamel white finish
- Chrome plated brass strainer
- Fits AMERICAN STANDARD, CRANE, ELJER, KOHLER, and other cast iron service sinks

PART #	d EsCRIPt ION
60003	3" IPS

sINK OvERFLOW - COMMERCIAL

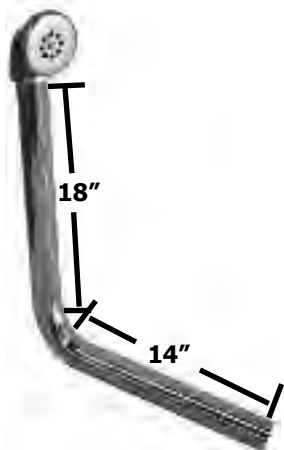

- Chrome plated brass
- 1-1/4" x 14" x 18" tube
- 1-1/4" satin chrome plated elbow
- Stainless steel overflow strainer & screw

PART #	d EsCRIPt ION
33141	Strainer with 1-1/4" elbow
33142	1-1/4" x 14" x 18" brass overflow elbow for slip joint connection
33144	Strainer only
33147	Complete unit as shown

PARTs FOR LEVER AND tWist dRAINS

P-tRAPs - BRAss



part#34310
part#34315



part#34300
part#34305

- LYNCAR'S p-traps in cast brass
- Available in 1-1/2" or 2" sweat connections
- With or without cleanout

PART #	d EsCRIPt ION
34300	Brass trap with cleanout 1-1/2"
34305	Brass trap with cleanout 2"
34310	Brass trap less cleanout 1-1/2"
34315	Brass trap less cleanout 2"

sINK stAND PIPEs



part# 33622
Drain Assembly



part#33623



part#33624

- For bars, restaurants and laboratories
- Easy to install!
- Simply insert into drain and walk away!
- Chemical resistant
- Plastic tube is easy to adjust, simply cut with ordinary tools
- Standard chemical resistant poly-stainless
- A co-polymer alloy for stainless steel sinks, bars, and restaurants
- High chemical resistant model for laboratories is available, please call

PART #	d EsCRIPt ION
33620	1" stand pipe assembly
33621	1-1/2" stand pipe assembly
33622	1" poly stainless drain assembly
33623	1-1/2" poly stainless drain assembly
33624	Nut adapter 1-1/2 x 1"

COMMERCIAL ExPOsEd sHOWER



- Economical, yet ruggedly constructed for outdoor installations
- Deck - patio - pool
- Wall mount
- Chrome plated brass
- 7" to 9-1/2" wall adjustment
- Adjustable low flow showerhead
- 6" adjustable wall bracket
- Cross handles
- 24" riser
- 1/2" IPS female inlets

PART #	d EsCRIPt ION
67252	7" to 9-1/2" wall adjustment

sELF CLOsING vALvEs

vALvE - sELF CLOsING sHOWER



- Chrome plated brass
- 10" pull chain
- Connect from water supply to showerhead
- Indoor or outdoor use
- Approximately 2-1/2" x 3-3/4"
- cUPC approved

vALvE - sELF CLOsING stOP



- Chrome plated brass
- Cross handle
- Spring loaded for fast close
- Use on: outdoor showers, foot washing stations and urinals
- cUPC approved

PART # **dEsCRIPtION**
2193 1/2" FIP inlet and outlet

PART # **dEsCRIPtION**
2192 1/2" FIP x 1/2" FIP

FAuCEt - sELF CLOsING



- Chrome plated brass
- 1/2" IPS shank
- Low flow aerator
- Complete with locknut and rosette
- cUPC approved

sELF - CLOsING LAVAtORY FAuCEtS HEAvy duty



- Lever handle
- Low flow aerator
- Vandal resistant cap
- Chrome plated brass
- 1/2" IPS shank
- Complete with locknut and rosette

PART # **dEsCRIPtION**
2191 Faucet self closing

PART # **dEsCRIPtION**
21932 Heavy duty / self closing

COMMERCIAL FAUCETS AND DRAINS

SELF - CLOSING WALL FAUCETS - HEAVY DUTY



- Lever handle
- Vandal resistant cap
- No aerator
- Chrome plated brass

PART #	DESCRIPTION
21937	1/2" FIP inlet

FAUCET - QUARTER TURN LAVATORY



- Chrome plated brass
- Low flow aerator
- Hot or cold cross handle
- 1/2" IPS shank
- Complete with locknut and rosette
- Not self closing

PART #	DESCRIPTION
21805	Hot handle
21806	Cold handle

GLASS FILLER - WALL MOUNT



- Chrome plated brass
- Volume control screw
- Instant shut-off
- Cushioned chrome plated brass push arm

part#12003 With flange 3-3/4" centre of spout to wall

PART #	DESCRIPTION
12003	3/8" IPS female inlet
12020	3/8" x 2-1/4" IPS male inlet

Push Button Faucet

FAuCEt - PusH Butt ON sELF CLOsING



- Chrome plated brass
- Low flow aerator
- Complete with locknut and rosette
- Non-adjustable slow close
- Closes in approximately 6 seconds at 60 PSI
- Economical

PART # **dEsCRIPt ION**
21803 1/2" IPS shank

vALvE - PusH Butt ON sELF CLOsING 90°



- 1/2" FIP inlet and outlet valve only, no nipples
- PLEASE NOTE:
- Use either **part#993** flush tube or **part#984** nut and fine thread flush tube to adapt the above valves into flush valves

PART # **dEsCRIPt ION**
21810 Chrome plated brass

FAuCEt - PusH Butt ON sELF CLOsING LAVAt ORy



- PLUMBERS QUALITY
- Chrome plated brass
- Low flow aerator
- 1/2" IPS shank
- Complete with locknut and rosette
- With regulated slow close timing screw

PART # **dEsCRIPt ION**
21800 Plumbers quality

vALvE - PusH Butt ON sELF CLOsING 180°



- Chrome plated brass
 - 0-20 second adjustment 2.75 GPM
- PLEASE NOTE:
- Use either **part#993** flush tube or **part#984** nut and fine thread flush tube to adapt the above valves into flush valves

PART # **dEsCRIPt ION**
21830 1/2" FIP inlet and outlet valve ONLY, no nipples

uRINAL PARTs

uRINAL LARGE - stRAINERs CAuLk tO 2" dWv



- For wall to floor urinals
- Flat or beehive
- Stainless steel strainer
- Brass body
- Strainer screw holes on 3-5/16" centres
- 4-3/8" across flange

PARt #	dEsCRIPt ION
970	Flat strainer complete
971	Beehive strainer complete
972	Flat grill with screws
973	Beehive grill with screws

uRINAL - FLuSH tUBEs



- 3/4" OD CP brass

PARt #	dEsCRIPt ION
986	6-1/2" long, fine thread - one end
989	15" long, fine thread - one end
993	6-1/2" long, 1/2" MPT - one end
997	8" long, NO threads - both ends

uRINAL - COuPLING Nut FOR FLuSH tUBEs



- Chrome plated brass

PARt #	dEsCRIPt ION
984	3/4" fine thread x 1/2" MPT

uRINAL - sPud Nut & EsCutCHEON



PARt #	dEsCRIPt ION
980	3/4" IPS spud nut & washer
981	Escutcheon
982	Spud nut, escutcheon & washer

uRINAL PARTs

uRINAL - OutLet sPud - BRASS



- With bolts, washers and nuts and **part#2096 (page C-2)** sponge type gasket
- IPS or sweat connection

PART #	dRAIN CONNECT ION	uRINAL tYPE	BOLt HOLE CENT ERs
94700	2" IPS	CRANE	5-1/2"
94701	2" Sweat	CRANE	5-1/2"
94705	2" Sweat	AM/STD	4"
94706	2" IPS	AM/STD	4"
94707	2" Sweat	ELJER	4-1/4"

uRINAL - ANd CLOsEt sPuds



PART #	tYPE	sIZE	LOCKNut	WAsHER
956	Closet	2"	Brass	part#2085
957	Closet	2" x 1-1/2"	Brass	part#2086
958	Closet	2" x 1-1/4"	Brass	part#2087
959	Closet	1-1/2"	Brass	part#2088
960	Closet	1-1/4"	Brass	part#2089
961	Urinal	1" x 3/4"	Brass	part#2090
962	Urinal	1-1/4" x 3/4"	Brass	part#2089
963	Closet	1-1/2" x 1-1/4"	Brass	part#2088

uRINAL sCREEN, sCENT Ed



- Universal shape
- Economical order control
- Length 19 cm / 7-1/2"
- Red, with cherry scent

PART #	dEsCRIPt ION
966	Urinal screen, scented

uRINAL sCREEN WIt H dEOdORIZING BLOCK



- A disposable vinyl urinal screen which prevents foreign objects like chewing gum, matches and cigarette butts from being flushed down the urinal drain.
- The deodorizing block releases a pleasant fragrance with each flush and also releases a caustic which attacks clogging urinal salts.

PART #	dEsCRIPt ION
967	Urinal screen with deodorizing block

dEOdORIZING BLOCK



- The deodorizing block releases a pleasant fragrance with each flush and also releases a caustic which attacks clogging urinal salts.

PART #	dEsCRIPt ION
965	Urinal deodorizing block

uRINAL PARTs

uRINAL stRAINER



- Top quality stainless steel with mounting hardware
- Photo shown is **part#969**

PART #	dEsCRIPt ION
969	AMERICAN STANDARD
968	CRANE

uRINAL FLANGE kIt PvC 2" Adjust ABLE



- PVC plastic
- Complete with gasket
- Hub / inside / spigot versions

PART #	dEsCRIPt ION
975	Adjustable hub flange
976	Adjustable inside fit
977	Adjustable spigot style

WALL HuNG CLOsEt AND uRINAL GAsket kIt



- Works with all manufacturers
- Kit includes:
 - Chemical resistant sponge gasket
 - Alignment ring
 - Adhesive tape
 - OD 3-1/2"

PART #	dEsCRIPt ION
2062	Closet gasket
2064	Urinal gasket

WALL HuNG tOILEt stABILIZER sEAL GAsket

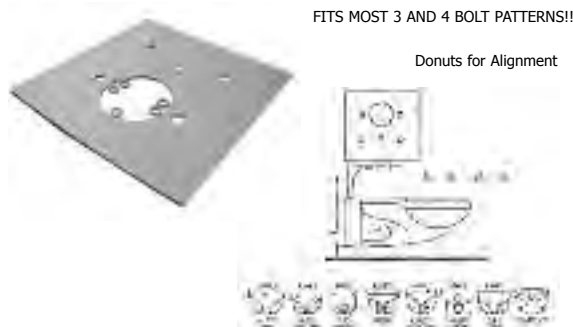

Works with toilets – 1.6 GPF thru 4.5 GPF

- TP rubber construction creates a total seal
- Self forming material eliminates wobbles and rocking
- Trim with ordinary razor blade knife
- Greatly reduces risk of cracked bowls
- Protects the wall & ceilings below from water damage
- Protects against cracked mounting
- Available in standard white
- Custom colours upon request

PART #	dEsCRIPt ION
1009	Wall hung toilet

HANGERS

LAVATORY HANGER, IRON



- 10-1/2" wide
- Extra heavy cast iron

PART #	DESCRIPTION
1219	Lavatory hanger, 10"

URINAL / LAVATORY HANGER



- Stamped steel

PART #	DESCRIPTION
1220	Lavatory hanger

Z - HANGER, IRON



- Adjustable for enameled iron or china lavatories
- For iron, side lugs fit the pockets
- For china, knock off the side lugs 5" to 16" adjustment
- Cast iron

PART #	DESCRIPTION
1221	Z - Hanger, adjustable

LAVATORY HANGER, STEEL



- For china lavatories
- Stamped steel
- Plated for corrosion resistance
- 8" wide

PART #	DESCRIPTION
1222	Lavatory hanger, 8" steel

LAVATORY HANGER - AMERICAN STANDARD style, STEEL



- Designed to fit AMERICAN STANDARD style lavatories
- Stamped steel
- Plated for corrosion resistance
- 10-1/2" wide

PART #	DESCRIPTION
1223	Lavatory hanger - AMERICAN STANDARD style

CARRIER Nuts AND dRINKING FOuNtAIN

CARRIER Nuts & WASHERs



st ANd ARd



Ext ENd Ed

- For wall hung toilets and urinals
- Four sets of hardware per bag

PART #	dEsCRIPt ION
33128	Standard, 4 per bag
33217	Extended, 4 per bag

REtRO FIt kIt WItH sAFEtY FLANGE FOR BuBBLER



- Brass body bubbler with "flex- flange"
- Stainless steel cartridge
- Retro kit consists of: 1/2" x 3/8" x 3-1/2" nipple
- Stainless steel flange, rosette, locknut, coupling nut and 1-3/4" cockhole cover

PART #	dEsCRIPt ION
2199	Retro fit kit with safety flange bubbler

dRINKING FOuNtAIN CONvERsION kIt



- Our Retrofit Kit **part#2197 (page A-20)** added with **part#55500 (page F-1)** 12" supply line 1/2" IPS x 3/8 OD compression , **part#3329 (page F-8)** quarter turn valve
- Converts a twist handle fountain to a push button unit
- Easy to install

PART #	dEsCRIPt ION
2197As	Conversion kit

dRINKING FOuNt AINs

dRINKING FOuNt AIN - REt RO - Fit kIt PusH Butt ON



KIT CONTAINS:

- **Part#2194** chrome plated brass bubbler head with stainless steel cartridge
- 1/2" x 3/8" x 3-1/2" nipple brass
- Polished stainless steel flange
- Rosette, locknut & coupling nut
- 1-3/4" cockhole cover

PART # dEsCRIPt ION

2197 Retro-Fit Kit

BuBBLER WIt H "FLEx FLANGE"



- Stainless steel cartridge
- LYNCAR bubbler with rubber "flex" flange to protect teeth and mouth
- Grey rubber front
- Easy to replace when required

PART # dEsCRIPt ION

2196 Bubbler - with "Flex" flange

2196sF Rubber replacement - plastic safety front flange

2198 Retrofit unit - accessory package for bubbler

dRINKING FOuNt AIN - PusH Butt ON



- 3/8" FIP
- Chrome plated brass
- Stainless steel cartridge
- Replaces HAWS HW5010

PART # dEsCRIPt ION

2194 Drinking fountain bubbler with lead free cartridge

BuBBLER PARTs

ACCEssORy PACKAGe FOR BuBBLER



- Parts only to change old style bubbler to push button
- Includes:
 - 1/2" x 3/8" x 3-1/2" brass nipple
 - Stainless steel flange
 - Cockhole cover 1-3/4"
 - Rosette, locknut & coupling nut

PART #	dEsCRIPt ION
2198	Accessory package for bubbler

REPLACEMENT CARtRIdGE FOR BuBBLER



- Stainless steel replacement cartridge
- Fits **part#2197**, **part#2196**, and **part#2194**

PART #	dEsCRIPt ION
2195	Replacement cartridges

REPLACEMENT BuBBLER PARTs



part#2194-1



part#2194-2



part#2194-3



part#2194M



part#2187
part#2188

PART #	dEsCRIPt ION
2194-1	Chrome collar for button
2194-2	Chrome push button
2194-3	Cartridge retention bushing
2194-6	Inlet washer
2194M	Mouthpiece set for part#2194
2196F	Rubber flange replacement for part#2196
2196M	Mouthpiece set for part#2196
2187	Nipple 1/2 x 3/8 x 3-1/2
2188	Long nipple 1/2 x 3/8 x 4-1/2

BuBBLER PARTs

vALvE - REMOtE PusH Butt ON



- Superior quality
- Chrome plated brass button and escutcheon
- 1/4" FIP
- Lead-free cartridge

PARt #	dEsCRIPt ION
2179	Remote push button

FOuNtAIN 2-IN-1 WRENCH



- Tightens or loosens cartridge retaining bushing
- Prevents bushing thread damage which causes leaks

PARt #	dEsCRIPt ION
7047	Fountain 2-in-1 wrench

dRINKING FOuNtAIN - sELF CLOsING



- 1/2" FIP
- Chrome plated brass
- Flow regulator screw
- Cross handle
- Precision ball bearing action

PARt #	dEsCRIPt ION	APPROvAL
2190	Drinking fountain, FIP 1/2" connection	cJPC
2190-05	Handle cap nut	
2190-13	Regulator screw cap nut	
2190Rk	Repair kit	

FLUSH VALVE PARTS FOR CRANE

CRANE FLUSH VALVE HANDLE



- Flush handles
- With stem and nut
- Chrome brass fittings

PART #	DESCRIPTION
32900	CRANE flush valve handle, stem size 1-15/16", blue tip, for FLUSHBOY & REX
32907	PRESTO/ EMPIRE / REX non hold open, stem size 1-9/16", white tip
32908	PRESTO / EMPIRE, stem size 1-11/16", blue tip

CRANE STEM & VALVES

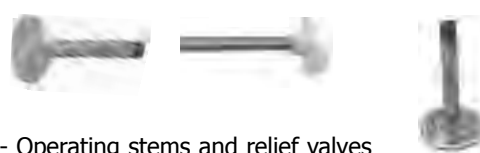

- Operating stems and relief valves

PART #	DESCRIPTION
32901	1-9/16" FV stem, white tip
32902	1-15/16 FV stem, blue tip
32903	1-11/16 FV stem, blue tip
32909	Relief valve, long tip for FLUSHBOY
32910	Relief valve, short tip for PRESTO / REX

CRANE PRESTO KITS



- Urinal and closet
- Parts kit (4pc) for PRESTO, REX
- Leather diaphragm
- CRANE OEM ref#39002 / 39003

PART #	DESCRIPTION
32912	4 pc kit for urinal (3/4" stop)
32914	4 pc kit for closet (1" stop)

PRESTO DIAPHRAGM ASSEMBLY



- Fits PRESTO/ EMPIRE
- Major rebuild kits for closet and urinal
- Less seat assembly
- Crane OEM ref#39007 / 39008

PART #	DESCRIPTION
32916	Major rebuilt kit urinal (3/4" stop)
32918	Major rebuild kit closet (1" stop)

FLUSH VALVE COMPLETE REPAIR KITS



- For CRANE, DELANY, PRESTO
- Full parts (6pc) for PRESTO / REX
- Vacuum breaker and stem
- Leather diaphragm
- CRANE OEM ref#39002 / 39003

PART #	DESCRIPTION
32906	6pc kit for urinal (3/4" stop)
32904	6pc kit for closet (1" stop)

VACUUM BREAKER



- Vacuum breaker for CRANE
- Rubber sleeve
- CRANE OEM ref#302002

PART #	DESCRIPTION
32913	Vacuum breaker

DIAPHRAGM FOR PRESTO



- Leather diaphragm for PRESTO
- CRANE OEM ref# 302075

PART #	DESCRIPTION
32915	Diaphragm

FLEX MEMBER



- Rubber flex member for flush valve handle
- CRANE OEM ref# 302022

PART #	DESCRIPTION
32917	Flex member

OEM numbers, registered trademarks, faucet name, and manufacturer listed above are supplied and listed for your reference only.

FLuSH vALvE PARTs FOR sLOAN

sLOAN FLuSH vALvE HANdLE



- Also Fits ZURN C.P METAL
- FOR ROYAL, REGAL, and CROWN Closet or urinal valves
- OEM ref#B32A

PART #	dEsCRIPtION
32920	SLOAN flush valve handle

sLOAN FLuSH vALvE REPAIR kIt



- Repair Kit
- For ROYAL, REGAL, and CROWN closet or urinal valves
- OEM ref#B50A

PART #	dEsCRIPtION
32922	SLOAN flush valve handle

sLOAN COMPLEt E FLuSH vALvE REBuILd kIt



- Diaphragm, guide, disc etc.(includes self cleaning by pass valve)
- Uses a A156A diaphragm
- New SLOAN 3pc style
- OEM ref#A1041A

PART #	dEsCRIPtION
32930	1.6 GPM for toilet

sLOAN PLAstIC FLuSH vALvE GuIdE



- For ROYAL, REGAL, and CROWN Closet or urinal valves
- OEM ref#A163A

PART #	dEsCRIPtION
32926	SLOAN plastic flush valve guide

sLOAN FLuSH vALvE dIsC



- For ROYAL & REGAL
- Closet or urinal valves, 2" diameter
- OEM ref#A15A
- Also fits ZURN

PART #	dEsCRIPtION
2068	SLOAN flush valve disc

sLOAN dIAPHRAGM



- For ROYAL & REGAL
- Closet or urinal valves, 3-1/4" diameter
- OEM ref#A156A
- Also fits ZURN

PART #	dEsCRIPtION
2069	SLOAN diaphragm

vACuUM BREAKER



- Vacuum breaker repair kit
- SLOAN flush valve, fits SLOAN, ZURN and others
- OEM ref#Z6600B

PART #	dEsCRIPtION
21842	Vacuum breaker

* FOR SLOAN FLUSH VALVE REPAIR TOOL
(PART #992180) SEE PAGE L-19

sLOAN COMPLEt E FLuSH vALvE REBuILd kIt



- Relief valve, disc, diaphragm, body guide
- Original SLOAN style

PART #	sLOAN PART #	FOR
21843	A42A	1gpm urinal
21844	A37A	1.5gpm urinal
21846	A36A	4.5gpm urinal
21847	A38A	3.5gpm toilet & urinal
21848	A41-A	1.66gpm toilet

OEM numbers, registered trademarks, faucet name, and manufacturer listed above are supplied and listed for your reference only.

REPAIR/REBuILd kIt s

ZuRN AQuAFLuSH REPAIR kIt



- For closet and urinal
- Combo Kit
- OEM ref#Z6000

PART #	dEsCRIPt ION
32932	ZURN AQUAFLUSH repair kit

ZuRN AQuAFLuSH REBuILd kIt



- For closet and urinal
- Same as **part#32932** but adds vacuum breaker, handle repair kit and o-ring

PART #	dEsCRIPt ION
32934	ZURN AQUAFLUSH rebuild kit

FLuSH vALvE REBuILd kIt



- Fits most ROYAL, REGAL, SLOAN ZURN models
- Includes inside parts, vacuum breaker, handle seal kit shut off cup, tailpiece, o-ring, gpf reducers
- OEM ref#A-1002-A

PART #	dEsCRIPt ION
21838	Flush valve rebuild kit

dELANy REBuILd kIt



- Critical parts for DELANY flush boy shut off valve
- Rebuild kit
- OEM ref#FB44-4AJ

PART #	dEsCRIPt ION
33955	DELANY Rebuild Kit

sLOAN ACt uAt OR CARt RIId GE



- Replacement for SLOAN, ROYAL/REGAL
- Sub assembly actuator

PART #	dEsCRIPt ION
32950	For Hydraulic OEM ref#HY-83-A
32952	For Solenoid OEM ref#EL-128-A

OEM numbers, registered trademarks, faucet name, and manufacturer listed above are supplied and listed for your reference only.

REPLACEMENT PARTS FOR tECK

tECK / CAMBRIDGE BRASS UNIVERSAL HANDLE REPAIR KIT



- Except for 82T (pre 1975), and electronic models
- Kit includes following parts:
Handle cage, relief valve, seat washer, spring, o-rings (2), cage, push pin, spring, handle (2), rubber washer, bonnet (2), handle gland (2) plastic insert
- OEM ref#76602 (TV50)

PART #	DESCRIPTION
33902	Handle repair kit

tECK / CAMBRIDGE BRASS, FLUSH VALVE REPAIR KIT



- Concealed body, all models except for 82T (pre 1975)
- Kit includes:
Regulating screw, fibre gasket (2), diaphragm, handle seat washer, spring (2) leather gasket, flexible washer, push pin, relief valve, o-ring (3), screw, handle cage
- OEM ref#76601 (TV111)

PART #	DESCRIPTION
33901	Flush valve parts

tECK / CAMBRIDGE BRASS, FLUSH VALVE REPAIR KIT



- Exposed body, all models except for 82T (pre 1975)
- Kit includes:
Fibre gasket (3), diaphragm, handle seat washer (2), leather gasket, flexible washer, push pin, o-ring (6), screw
- OEM ref#76600 (TV107)

PART #	DESCRIPTION
33900	Flush valve parts

tECK / CAMBRIDGE BRASS, HANDLE CAGE ASSEMBLY



- Except for 82T (pre 1975), and electronic models
- Kit includes handle cage and o-ring
- OEM ref#77191

PART #	DESCRIPTION
33906	Universal handle repair kit

OEM numbers, registered trademarks, faucet name, and manufacturer listed above are supplied and listed for your reference only.

REPLACEMENT PARTS FOR tECK

dELtA / CAMBRIdGE BRAss tEMPus METERING REPLACEMENT



- DELTA / CAMBRIDGE brass tempus metering
- Replacement cartridge
- For single and 4" centreset faucets
- OEM ref#060160A

PART # dEsCRIPt ION

11350 DELTA / CAMBRIDGE Brass Tempus

11350Q DELTA / CAMBRIDGE Brass Tempus - bulk

tECK / CAMBRIdGE BRAss dIAPHRAGM WitH GuIdE



- OEM ref#70230

PART # dEsCRIPt ION

33905 Diaphragm with guide

tECK / CAMBRIdGE BRAss, dIAPHRAGM



- OEM ref#10316

PART # dEsCRIPt ION

33903 Diaphragm

tECK / CAMBRIdGE BRAss, vB sLEEvE



- For all models including electronic
- Overall length is 2"
- OEM ref#70267

PART # dEsCRIPt ION

33904 VB sleeve

OEM numbers, registered trademarks, faucet name, and manufacturer listed above are supplied and listed for your reference only.

TUBULAR

P-TRAP LESS CLEANOUT



- 20 gauge
- Ground joint connection
- Deep flange
- Brass nuts
- 7-1/2" wall bend
- Brass units less flange

PART#	FINISH	SIZE
13860	Chrome plated	1-1/4"
13860B	Rough brass	1-1/4"
13860BN	Brushed nickel	1-1/4"
13861	Chrome plated	1-1/2"
13877	Rough brass	1-1/2"

SEMI CAST P-TRAPS, WITH CLEANOUT



- 17 gauge
- Ground joint
- Semi-cast p-trap with cleanout and flange
- Includes:
 - Cast J bend
 - Deep flange
 - Brass nuts
 - 7-1/2" wall tube
 - Brass units less flange

PART#	FINISH	SIZE
13866	Chrome plated	1-1/4"
13900	Rough brass	1-1/4"
13867	Chrome plated	1-1/2"
13905	Rough brass	1-1/2"

TUBULAR

P-TRAP - 22GA



- 22 gauge renovation p-trap
- Zinc nuts
- Ground front
- 7-1/2" wall bend
- Deep flange

PART#	DESCRIPTION
13859	1-1/4" p-trap

P-TRAP - 17GA



- 17 gauge heavy duty p-traps
- Brass nuts
- Grounded joint connection
- 7-1/2" wall bend with flange
- cUPC approved

PART#	DESCRIPTION
13868	1-1/4" p-trap
13869	1-1/2" p-trap

T-TRAP



- 20 gauge t-trap
- Vessel trap
- 2" trap
- 8" height
- 14" wall bend
- 1-1/4" chrome brass
- Easy to cleanout

PART#	DESCRIPTION
13919	Chrome plated
13919BN	Brushed nickel

TUBULAR

P-TRAPS - EXTENDED VANITY TRAPS



- 20 gauge
- Brass nuts
- Ground front
- 15" wall bend
- Deep flange
- cUPC approved

PART#	DESCRIPTION
13910	1-1/4" Chrome plated
13915	1-1/4" Brushed nickel

SEMI-CAST P-TRAP - EXTENDED

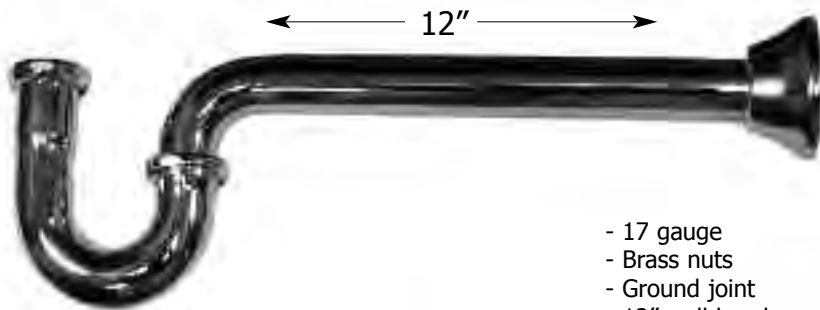

- 17 gauge
- Brass nuts
- Ground joint
- 12" wall bend
- Deep flange
- cUPC approved

PART#	DESCRIPTION
13912	1-1/4" Chrome plated
13917	1-1/2" Chrome plated

SEMI-CAST P-TRAP - EXTENDED WITH CLEANOUT

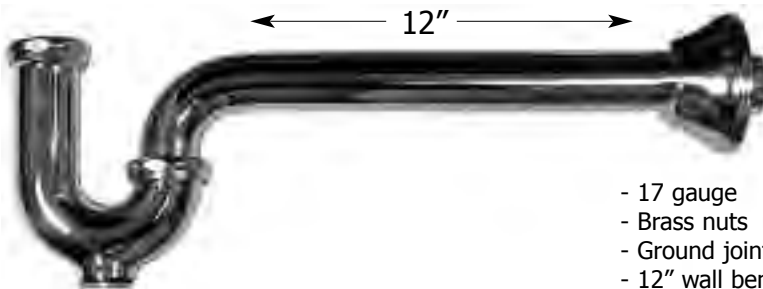

- 17 gauge
- Brass nuts
- Ground joint
- 12" wall bend
- Deep flange
- cUPC approved

PART#	DESCRIPTION
13913	1-1/4" with cleanout
13918	1-1/2" with cleanout

TUBULAR

J BEND - CHROME PLATED



- 20 gauge
- Chrome plated
- Brass nuts
- cUPC approved

S BEND - CHROME PLATED



- 20 gauge
- Chrome plated brass nuts
- Deep flange

PART# DESCRIPTION

- 13862** J bend 1-1/4"
- 13863** J bend 1-1/2"

PART# DESCRIPTION

- 13864** S bend 1-1/4"
- 13865** S bend 1-1/2"

END OUTLET DIRECT CONNECT



- 20 gauge
- 16" centres
- Rough brass
- Brass nuts
- cUPC approved

END OUTLET SLIP JOINT STYLE



- 20 gauge
- 16" centres
- Rough brass
- Brass nuts
- cUPC approved

PART# DESCRIPTION

- 13940** 1-1/2" diameter

PART# DESCRIPTION

- 13941** 1-1/2" diameter

CENTRE OUTLET DIRECT CONNECT STYLE



- 20 gauge
- 16" centres
- Rough brass
- cUPC approved

END OUTLET DIRECT CONNECT STYLE



- 20 gauge
- 16" centres
- Rough brass
- With dishwasher tailpiece
- 1/2" hose clamp or copper sweat branch
- cUPC approved

PART# DESCRIPTION

- 13942** 1-1/2" diameter

PART# DESCRIPTION

- 13943** 1-1/2" diameter

TUBULAR

FLANGED STRAINER TAILPIECE



PART#	GAUGE	SIZE	FINISH	LENGTH
13858	22	1-1/2"	Rough brass	2-5/8"
13854	22	1-1/2"	Rough brass	4"
13854C	22	1-1/2"	Chrome plated	4"
13855	22	1-1/2"	Rough brass	6"
13848	22	1-1/2"	Rough brass	8"
13849	22	1-1/2"	Rough brass	12"

SLIP JOINT TUBULAR EXTENSIONS



PART#	GAUGE	SIZE	FINISH	LENGTH
13840	22	1-1/4"	Chrome plated	6"
13841	22	1-1/4"	Chrome plated	8"
13842	22	1-1/4"	Chrome plated	12"
13843	22	1-1/2"	Chrome plated	6"
13844	22	1-1/2"	Chrome plated	8"
13845	22	1-1/2"	Chrome plated	12"

SOLDER TUBULAR EXTENSIONS



PART#	GAUGE	SIZE	FINISH	LENGTH
13856	22	1-1/4"	Chrome plated	6"
13846	22	1-1/4"	Chrome plated	8"
13857	22	1-1/2"	Chrome plated	6"
13847	22	1-1/2"	Chrome plated	8"

THREADED TAILPIECE THREADED BOTH ENDS



PART#	GAUGE	SIZE	FINISH	LENGTH
13881	20	1-1/4	Chrome plated	4"
13851	20	1-1/4	Chrome plated	6"
13878	20	1-1/4	Chrome plated	8"
13879	20	1-1/4	Chrome plated	12"
13852	20	1-1/2	Chrome plated	6"
13883	20	1-1/2	Chrome plated	8"
13885	20	1-1/2	Chrome plated	12"

THREADED TAILPIECE THREADED ONE END



PART#	GAUGE	SIZE	FINISH	LENGTH
13884	20	1-1/4	Chrome plated	4"
13886	20	1-1/4	Chrome plated	6"
13888	20	1-1/4	Chrome plated	8"
13880	20	1-1/2	Chrome plated	6"
13882	20	1-1/2	Chrome plated	8"

REDUCING TAILPIECE



PART#	GAUGE	SIZE	FINISH	LENGTH
13890	20	1-1/2 x 1-1/4	Chrome plated	8"

TUBULAR

DISHWASHER TAILPIECE THREADED TOP



- 20 gauge
- Rough brass
- 1-1/2" size
- Threaded top
- Dishwasher Branch: 1/2"

PART# DESCRIPTION

- 13891** 6" long
- 13896** 8" long

DISHWASHER TAILPIECE DIRECT CONNECT TOP 1/2"



- 20 gauge
- Rough brass
- 1-1/2" size
- Direct connect top
- Dishwasher branch: 1/2"

PART# DESCRIPTION

- 13892** 6" long
- 13895** 8" long

DISHWASHER TAILPIECE DIRECT CONNECT TOP 3/4"



- 20 gauge
- Chrome or rough brass
- 1-1/2" size
- Direct connect top
- Dishwasher branch: 3/4" sweat copper

PART# DESCRIPTION

- 13853** 6" long, chrome plated
- 13853B** 6" long, rough brass

DISHWASHER TAILPIECE SLIP JOINT TOP CONNECTOR



- 22 gauge
- Rough brass
- 1-1/2" size
- Slip joint top connector
- Dishwasher branch: hose thread or 1/2" sweat copper

PART# DESCRIPTION

- 13897** 6" long

17 GAUGE CENTRE OUTLET TEE



- 17 gauge
- Chrome plated
- 1-1/2" size

PART# DESCRIPTION

- 13923** Centre outlet tee

17 GAUGE END OUTLET TEE



- 17 gauge
- Chrome plated
- 1-1/2" size

PART# DESCRIPTION

- 13922** End outlet tee

TUBULAR

B

TUBULAR

20 GAUGE TEE



- 20 gauge
- Chrome plated
- 1-1/2" size

PART#	DESCRIPTION
13926	1/2" tee

20 GAUGE COUPLING



- 20 gauge
- Chrome plated

PART#	DESCRIPTION
13925	1-1/4" coupling
13924	1-1/2" coupling

20 GAUGE ELBOW 45°



- 20 gauge
- Chrome plated

PART#	DESCRIPTION
13928	1-1/4" elbow 45 degrees
13927	1-1/2" elbow 45 degrees

20 GAUGE ELBOW 90°



- 20 gauge
- Chrome plated

PART#	DESCRIPTION
13930	1-1/4" elbow 90 degrees
13929	1-1/2" elbow 90 degrees

SOLDER COLLAR - BRASS



- 1-1/2" thread

PART#	DESCRIPTION
1314	For Tubular, 1-1/2" collar
1315	For CWT, 1-5/8" collar

TAILPIECE WASHER



- Cloth inserted rubber washer
- For tailpiece

PART#	DESCRIPTION
2211	Tailpiece washer

TUBULAR

SLIP JOINT NUT



PART#	SIZE	MATERIAL	FINISH
1330C	1-1/4"	Zinc die cast	Chrome
1331C	1-1/2" x 1-1/4"	Zinc die cast	Chrome
1333C	1-1/2"	Zinc die cast	Chrome
1333P	1-1/2"	Zinc die cast	Rough
1336	1-1/4"	Brass	Rough
1336C	1-1/4"	Brass	Chrome
1337	1-1/2" x 1-1/4"	Brass	Rough
1337C	1-1/2" x 1-1/4"	Brass	Chrome
1338	1-1/2"	Brass	Rough
1338C	1-1/2"	Brass	Chrome
1339	2"	Brass	Rough
1339C	2"	Brass	Chrome

POLY WASHER FOR TAILPIECES



PART#	SIZE	DESCRIPTION
2214	1-1/2"	Beveled
2218	1-1/2" x 1-1/4"	Beveled
2219	1-1/4"	Beveled
2222	1-1/2"	Flanged

TRAP ADAPTERS



FEMALE COPPER SWEAT UNDER MPT

- Slip nut: rough brass
- Compression ring: brass



FEMALE IPS

PART#	A	DESCRIPTION
1942	1-1/4"	B male IPS: 1-1/4"
1943	1-1/4"	B male IPS:1-1/2"
1944	1-1/2"	B male IPS:1-1/2"
1945	1-1/4"	B female IPS:1-1/4"
1946	1-1/4"	B female IPS:1-1/2"
1947	1-1/2"	B female IPS:1-1/2"

COMPRESSION RINGS ONLY



BRASS	TYPE	SIZE
1990	Brass	1-1/4"
1992	Brass	1-1/2"

FLANGES & PLATES

FLANGE - SURE GRIP

- Chrome plated or polished brass



PART#	IPS	CWT	OD	TUBULAR	HEIGHT
1224	-	-	3"	1-1/2"	7/16"
1225	3/8"	-	2-1/2"	-	25/64"
1226	1/2"	-	2-1/2"	-	25/64"
1227	3/4"	-	2-1/2"	-	25/64"
1228	1-1/2"	-	3"	-	7/16"
1229	2"	-	3-1/4"	-	43/64"
1230	-	1/2"	2-1/2"	-	13/32"
1230PB	(Polished Brass)	1/2"	2-1/2"	-	13/32"
1231	-	3/4"	2-1/2"	-	-
1232	1-1/4"	1-1/2"	3"	-	1/2"
1233	1"	-	2-3/4"	-	1/2"
1240	-	2"	3-1/2"	-	25/64"
1241	-	1"	2-3/4"	-	1/2"
1244	-	-	3"	1-1/4"	7/16"

BOX FLANGE - SURE GRIP



- Chrome plated
- 1-3/4" height

PART#	IPS	OD	TUBULAR
1234	1-1/4"	3"	-
1235	1-1/2"	3"	-
1236	-	3"	1-1/4"
1237	-	3"	1-1/2"

FLANGE - EXTRA WIDE SURE GRIP



- Chrome plated

PART#	IPS	OD	TUBULAR	HEIGHT
1238	1-1/4"	3-1/2"	-	1/2"
1239	2"	3-1/2"	-	1/2"
1243	-	3-1/2"	2"	1/2"

BELL FLANGE - SURE GRIP

- Chrome plated or brushed nickel (part#2853BN)



PART#	IPS	CWT	OD	TUBULAR	HEIGHT
2841	3/8"	-	2-1/2"	-	1-1/4"
2842	1/2"	-	2-1/2"	-	1-1/4"
2843	3/4"	-	2-1/2"	-	1-1/4"
2844	1-1/4"	-	3"	-	1-1/4"
2845	-	1/2"	2-1/2"	-	1-1/4"
2846	1-1/2"	-	3"	-	1-1/4"
2848	-	3/8"	2-1/2"	-	1-1/4"
2853	-	-	3"	1-1/4"	1-1/4"
2853BN	Brushed Nickel	-	3"	1-1/4"	1-1/4"
2854	-	-	3"	1-1/2"	1-1/4"

TUBULAR

P.O & C.O. PLUGS

POP-UP DRAIN P.O.



- 3 pc mechanical pop-up
- With lift rod, plunger and linkage
- Chrome plated brass
- Polished brass and brushed nickel finishes also available
- Box packaged
- cUPC approved

COMBO POP-UP P.O.



- 50/50 unit
- ABS body
- C.P. brass top
- With lift rod, plunger and linkage
- Box packaged
- cUPC approved

PART#	DESCRIPTION
9991	3 pc Chrome
9991PB	3 pc Polished brass
9991BN	3 pc Brushed nickel

PART#	DESCRIPTION
9990	3 pc ABS / brass

POP-UP DRAIN C.O.



- 3 pc mechanical P.O. plug
- With lift rod, plunger and linkage
- Chrome plated brass
- Box packaged
- CSA approved

POP UP DRAIN 1 PC P.O.



- 1 pc unit
- With lift rod, plunger and linkage
- Chrome plated brass
- Box packaged

PART#	DESCRIPTION
9989	3 pc chrome

PART#	DESCRIPTION
9991E	1 pc chrome

TUBULAR

B

ABS POP-UP P.O.



- P.O. Plug
- 3 pc all ABS
- Box packaged
- CSA approved

PART#	DESCRIPTION
9994	3 pc all ABS

TUBULAR

PLUG & CHAIN P.O., 1 PIECE



- Chrome plated brass with overflow
- 1 piece P.O. plug
- 8" long
- Box packaged
- With stopper and chain
- cUPC approved

PART#	DESCRIPTION
9995	1 piece P.O. plug & chain 8"

PLUG & CHAIN P.O., 3 PIECE



- Chrome plated brass with overflow
- With stopper and chain
- Available with 6" or 4" tailpiece
- Box packaged
- cUPC approved

PART#	DESCRIPTION
9993	3 pc with 6" tailpiece
9997	3 pc with 4" tailpiece

TUBULAR

CLICK TOP PO/CO PLUG



- All brass design
- 1-1/4" x 6" tailpiece
- 2 piece style
- Push top open and close
- PO or CO styles
- cUPC approved

PART#	DESCRIPTION
9998	PO plug chrome
9998BN	PO plug brushed nickel
9999	CO plug chrome
9999BN	CO plug brushed nickel

DRAIN - COMMERCIAL LAV, OPEN GRID



- 17 gauge
- With tail piece
- Highest quality
- Chrome plated brass
- 1-1/4"x 6" tailpiece
- Brass locknut
- Rubber gasket
- cUPC approved

PART#	DESCRIPTION
9992	PO Style
9996	CO Style

DRAIN - HANDICAP STYLE LAV, OPEN GRID



- 17 gauge
- Highest quality
- Chrome plated brass
- 1-1/4"x 9" waste elbow
- Brass locknut
- Rubber gasket
- cUPC approved

PART#	DESCRIPTION
1177TP	PO Style
1178TP	CO Style

ABS WASTE & OVERFLOW KITS

WASTE & OVERFLOW HALF KIT (T/T)



- ABS waste and overflow half kits
- With tip toe style tub cartridge, brass stem, zinc body
- Includes the ABS tee fitting and all hardware
- Chrome and brushed nickel finishes
- cUPC approved

PART#	DESCRIPTION
13950	Chrome
13950BN	Brushed nickel

WASTE & OVERFLOW HALF KIT (L/T)



- ABS waste and overflow half kits
- With lift & turn tub cartridge, brass stem, zinc body
- Includes the ABS tee fitting and all hardware
- Chrome and brushed nickel finishes
- cUPC approved

PART#	DESCRIPTION
13955	Chrome
13955BN	Brushed nickel

WASTE & OVERFLOW HALF KIT CABLE DRIVE



- ABS waste and overflow half kits
- With cable drive assembly
- Cable is 35" long
- Includes the ABS tee fitting and all hardware
- Chrome and brushed nickel finishes
- Brass drain, stainless steel polished faceplate
- cUPC approved

PART#	DESCRIPTION
13960	Chrome
13960BN	Brushed nickel

TUBULAR REPAIR TRAP



- PVC repair trap for 1-1/4" or 1-1/2" drains
- Easy to repair and replace plastic or metal traps
- Simply clamp on

PART#	DESCRIPTION
FC150FT	PVC drain trap

TUBULAR

OVERFLOW PLATE WITH TRIP LEVER



- Square handle
- Covers 3-1/4" hole
- 2" bolt hole centres

PART#	FINISH	W/1148 BOLTS
1150	Chrome	None
1157	Chrome	2

OVERFLOW PLATE, 2 HOLE



- Covers 3-1/4" hole
- 2" bolt hole centres

PART#	DESCRIPTION	W/1148 BOLTS
1154	Chrome	None
1160	Chrome	2

TUB OVERFLOW PLATE



- Covers 3-1/4" hole

PART#	FINISH	W/1148 BOLTS
1152	Chrome	None
1152Q	Chrome	None
1159	Chrome	1

ABS TUB OVERFLOW PLATE



- Chrome plated ABS
- Covers 3-1/4" hole
- Includes plastic tie bar & gasket
- 3 screws

PART#	DESCRIPTION
1158	ABS tub overflow plate

OVERSIZED FIT-ALL OVERFLOW PLATE



- Chrome plastic overflow plate
- Oversized 3-1/2" diameter
- Replace old one and two hole plates
- Snaps on for a clean perfect finish
- Available in brushed nickel or oil rubbed bronze on request

PART#	DESCRIPTION
1153	Oversized FIT-ALL overflow plate
1153Q	Oversized FIT-ALL overflow plate - bulk

TUBULAR

WASHER - WASTE & OVERFLOW



- Sponge rubber

MACK WASHER



- For P.O. and C.O. plugs
- Variety of sizes
- 10 per pack

PART#	DESCRIPTION
2091	2-1/8" x 3-7/16" x beveled
2092	1-7/8" x 2-7/8" x 3/8"

PART#	SIZE
2071	1-1/4" wide
2070	1-5/16" wide
2072	1-3/8"
2073	1-1/2"
2074	1-1/4"

TIP-TOE DRAIN CARTRIDGE



- Plastic cartridge, rubber seal
- ABS Cover, with 5/16" Stem

LIFT & TURN STOPPER



- Zinc cover CP, with 3/8" stem

PART#	DESCRIPTION
13786	Tip-toe drain cartridge

PART#	DESCRIPTION
13785	Lift & turn stopper

LIFT & TURN DRAIN



- Chrome plated brass
- Complete assembly
- Universal design fits most waste / overflow models

TIP-TOE DRAIN



- Chrome plated brass
- Complete assembly
- Universal design fits most waste / overflow models

PART#	DESCRIPTION
1381	1-1/4"IPS
1382	1-1/2"IPS
1381W	1-1/4"IPS - replacement washer
1382W	1-1/2"IPS - replacement washer

PART#	DESCRIPTION
1383	1-1/4"IPS
1384	1-1/2"IPS
1381W	1-1/4"IPS - replacement washer
1382W	1-1/2"IPS - replacement washer

TUBULAR

SNAP & PRESS STOPPER



- For popular fine thread strainers
- Rubber seal
- ABS cover

PART#	DESCRIPTION
13787	1/4" stem, ABS stopper

WASTE AND OVERFLOW TRIM KIT



- Available in chrome, polished brass, brushed nickel
- Universal Fit for 1-1/2" & 1-3/4"
- Blister packaged

PART#	DESCRIPTION
13774	Tip toe style - chrome
13775	Tip toe style - polished brass
13776	Tip toe style - brushed nickel
13777	Push n pull style - chrome
13778	Push n pull style - polished brass
13779	Push n pull style - brushed nickel

WASTE SHOE



- 17 gauge tube
- Brass
- Fine thread
- Top quality, excellent seal

PART#	DESCRIPTION
1372	1-1/2"

TUB STRAINER



- Fine thread body
- 1/4" thread bottom post
- Fits 1-1/2" drains

PART#	DESCRIPTION
1374	Tub strainer, chrome plated brass

TUBULAR

B

TUBULAR

PO PLUG STOPPER - AM-STD



PART#	LENGTH x STOPPER DIAMETER
14006	4.71" x 1.48"

PO PLUG STOPPER - DELTA



PART#	LENGTH x STOPPER DIAMETER
14005	5.09" x 1.35"

PO PLUG STOPPER - ELJER



PART#	LENGTH x STOPPER DIAMETER
14007	4.15" x 1.29"

PO PLUG STOPPER - MOEN



PART#	LENGTH x STOPPER DIAMETER
14008	5" x 1.23"
14009	4.35" x 1.23"
14010	3.95" x 1.33"

PO PLUG STOPPER - PRICE PFISTER



PART#	LENGTH x STOPPER DIAMETER
14011	3.79" x 1.23"

PO PLUG STOPPER - STERLING



PART#	LENGTH x STOPPER DIAMETER
14012	4.24" x 1.33"

TUBULAR

PO PLUG STOPPER - VALLEY



PART#	LENGTH x STOPPER DIAMETER
14013	4.62" x 1.51"

PO PLUG STOPPER - UNIVERSAL



PART#	LENGTH x STOPPER DIAMETER
14014	5.00" x 1.22"
14015	5.09" x 1.35"

POP-UP REPAIR KIT



- 3pcs lever kit for P.O. & C.O. plugs

PART#	DESCRIPTION
9991R	Pop-up repair kit

CHEATER VENT



- Remodeling
- A quick solution to a tough problem
- Non-corroding ABS construction
- Replaces secondary plumbing venting
- Tested to NSF-24-19
- Withstands greater than 25lbs back pressure
- Actuates with less than 1/2lb PSI
- Maintains a 2.8" water column

PART#	DESCRIPTION
2066	Cheater vent

TUBULAR

STRAINER - SINK DOUBLE CUP



- Deep well sink strainer
- Stainless steel basket and strainer
- Fits sink openings 3-1/2" to 4"
- Double cup design for easy installation
- Positive sealing crumb cup with rolled edge

PART#	DESCRIPTION
2010DCT	With brass tail piece 2-3/4"

STRAINER - SINK, SUPREME STYLE



- Stainless steel double cup strainer
- Arrow clip style basket
- Fits 3-1/2" to 4" sink openings
- Positive sealing crumb cup
- Brass shank and tailpiece

PART#	DESCRIPTION
2010B	With brass tail piece 2-3/4"

SINK STRAINER - KIL STYLE



- "KIL" style strainer basket
- Fits 3-1/2" - 4" drains
- Stainless steel strainer
- Brass shank and tailpiece
- One per box

PART#	DESCRIPTION
2011	"KIL" sink strainer, with brass tailpiece 2-3/4"

STRAINER - OLD STYLE SINK



- 4-1/2" stainless steel body with strainer
- 3-1/2" opening with brass lock nut with tailpiece

PART#	DESCRIPTION
2010	Strainer - old style sink

TUBULAR

UNIVERSAL FIT



- Universal fit "Arrow Clip" strainers
- Stainless steel with chrome plated brass knob and short spring steel clip closure

PART#	DESCRIPTION
2012	"Arrow clip" strainers
2012Q	"Arrow clip" strainers - bulk

TWIST & SEAL



- "Twist & Seal" strainer
- Stainless Steel mechanism with positive seating metal stopper
- Chrome plated knob and brass stem

PART#	DESCRIPTION
20127	Twist & seal - packaged
20127Q	Twist & seal - bulk

CENTRE POST STYLE



- Deep drawn stainless steel construction with rolled edges

PART#	DESCRIPTION
20125	Centre post style
20125Q	Centre post style - bulk

DROP CENTRE NEOPRENE SEAL



- Deep drawn stainless steel construction with rolled edges

PART#	DESCRIPTION
20128	Drop centre neoprene seal
20128Q	Drop centre neoprene seal- bulk

4 DIMPLE PUSH DOWN



- Deep drawn stainless steel construction with rolled edges

PART#	DESCRIPTION
20126	4 dimple push down
20126Q	4 dimple push down - bulk

"KIL" STYLE BASKET STRAINER



- Deep drawn stainless steel construction with rolled edges

PART#	DESCRIPTION
20129	"KIL" style basket strainer
20129Q	"KIL" style basket strainer - bulk

TUBULAR

GARBAGE DISPOSER SHIELD



PART#	DESCRIPTION
1358	Garbage disposer shield

STRAINER - JUNIOR BASKET



- For 2" - 2-1/2" outlets
- Stainless steel body and basket
- Complete with washers and nuts
- cUPC approved



PART#	DESCRIPTION
1361	Complete unit
1361B	Basket only

STRAINER - JUNIOR DUO

For 2" - 2-1/2" Outlets



- For 2" - 2-1/2" outlets
- Stainless steel body and basket
- Complete with washers and nuts
- cUPC approved



PART#	DESCRIPTION
1365	Complete unit
1365B	Basket only

TRAY PLUG



- For 2" - 2-1/2" outlets
- Stainless body
- With plug
- Complete with washer & nuts
- cUPC approved



PART#	DESCRIPTION
1370	Tray plug

CRUMB CUP



- Chrome plated brass
- Can be used with **part#1370**

PART#	DESCRIPTION
1341	Fits sink - 1-7/8" x 1"
1344	Fits lavatory less post - 1-1/4" x 11/16"

STRAINER - FLAT DUPLEX



- For 2" - 2-1/2" outlets
- Stainless steel body and strainer
- Complete with washers and nuts
- cUPC approved



PART#	DESCRIPTION
1371	Strainer - flat duplex

NOTES

Lined area for notes.

CLOsET BOLTs, sCREWs, NUTs & WASHERs

BRAsS PLATED sTEEL CLOsET BOLTs

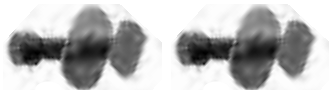

- 2 brass plated steel bolts
- 2 brass plated steel nuts
- 2 brass plated steel washers
- Packaged in pairs

PART#	DEsCRIPtION
-------	-------------

81	5/16" x 2-1/4" with washers and nuts
-----------	--------------------------------------

ALL BRAsS CLOsET BOLTs

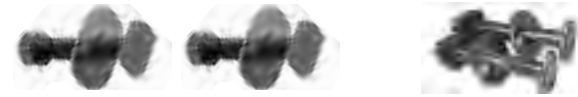

- 2 solid brass bolts
- 2 solid brass nuts
- 2 brass washers
- Packaged in pairs

PART#	DEsCRIPtION
-------	-------------

82	5/16" x 2-1/4" with oval washers
82R	5/16" x 2-1/4" with round washers

LONG BRAsS OvAl WASHER



- 2 solid brass bolts
- 2 solid brass nuts
- 2 solid brass oval washers
- Packaged in pairs

PART#	DEsCRIPtION
-------	-------------

83	5/16" x 3-1/2"
-----------	----------------

PLAsTIC BOLT ROUND WASHER



- 2 plastic bolts
- 2 plastic nuts
- 2 plastic round washers
- Packaged in pairs

PART#	DEsCRIPtION
-------	-------------

84	5/16" x 2-1/4"
-----------	----------------

BREAK-AWAY OvAl WASHER



- 2 brass bolts
- 2 brass nuts
- 2 brass oval washers
- Packaged in pairs

PART#	DEsCRIPtION
-------	-------------

82BB	5/16" x 2-1/4"
-------------	----------------

BOLT ONLY



- Solid brass

PART#	DEsCRIPtION
-------	-------------

112	5/16" x 2-1/4"
113	5/16" x 3-1/2"

NUT - BRAsS



- Rough brass finish

PART#	DEsCRIPtION
-------	-------------

133	5/16" open nut
------------	----------------

WASHER - CLOsET BOLT - BRAsS



- Rough brass finish

PART#	DEsCRIPtION
-------	-------------

142	Round washer
149	Oval washer

TOILET REPAIR

CLOSET BOLTS, sCREWs, NUTs & WASHERs

TOILET REPAIR

BOLT - TANK TO BOWL - sETs BRAss



- 2 - brass bolts 5/16" x 3"
- 4 - brass hex nuts
- 4 - cloth inserted rubber washers
- 4 - brass washers

PART#	DEsCRPTION
237	Bolt - tank to bowl - sets - brass
232	Bolt only
242	Washer only, rubber

TANK - TO BOWL CONNECTOR KIT



- 1 rubber gasket
- 2 - brass bolts 5/16" x 3"
- 4 - brass hex nuts
- 4 - cloth inserted rubber washers
- 4 - plated brass washers

PART#	DEsCRPTION
437	Regular gasket
438	CRANE red gasket recessed
439	AM-STD gasket recessed

gAsKET ONLY - TANK TO BOWL



- Sponge rubber

PART#	DEsCRPTION
2095	CRANE style
2096	Regular
2097	Recessed AM-STD
2098	CRANE red recessed

TOILET sEAT BOLTs

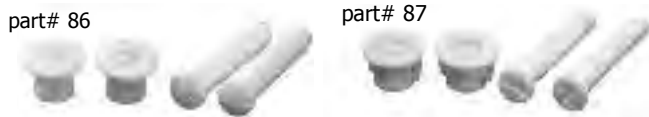

- Plastic toilet seat bolt sets, 2 sizes available
- 1 pair per hang bag or bulk packaging available

PART#	DEsCRPTION
86	7/16" x 2-1/4"
86Q	7/16" x 2-1/4" - bulk
87	3/8" x 2-3/8"
87Q	3/8" x 2-3/8" - bulk

TOILET sEAT sTABILIZERs



- Stops loose, twisting and wobbling toilet seats
- Tighten once and never again
- Works with all seats and hinges

PART#	DEsCRPTION
912	Retail bag of 6
912Q	Bulk bag of 50

CAP - PLAsTIC BOLT - ROUND



- Bottom snap washer included
- Available in package pair or poly bagged bulk

PART#	DEsCRPTION
913	White
913Q	White - bulk
914	Bone
914Q	Bone - bulk

TOILET REPAIR

TOILET REPAIR

TANK LEVER - vINTAgE



- Solid cast brass construction
- Premier finish
- Made to match most faucets & stop handles
- Fits most water closet mechanism

PART#	DEsCRPTION
1070	Straight lever
1071	45° lever

TANK LEvER - ACTUATOR hANDLE - AM-sTD



- For ROMA toilets series 1012
- Die cast metal handle
- Plastic arm

PART#	DEsCRPTION
1078	AM-STD push button 1012

TANK LEVER - shORT 4" AM-sTD



- 4" ABS plastic arm
- ABS handle
- Chrome, white, grey or bone

PART#	DEsCRPTION
1046	Chrome
1046W	White
1046g	Grey
1046B	Bone
1046Q	Chrome - bulk
1046WQ	White - bulk
1046gQ	Grey - bulk
1046BQ	Bone - bulk

TANK LEVERs

TANK LEVER - MED 6" AM-sTD



- 6" ABS plastic arm
- ABS handle chrome or white

PART#	DEsCRPTION
-------	------------

1066	Chrome
1066W	White
1066Q	Chrome - bulk
1066WQ	White - bulk

TANK LEVER - 28° FIT ALL - AM-sTD



- 4 to 6" adjustable arm in chrome, white, grey and bone
- ABS plastic
- 28° tank lever, fit all

PART#	DEsCRPTION
-------	------------

1067	Chrome
1067Q	Chrome - bulk
1067W	White
1067WQ	White - bulk
1067g	Grey
1067gQ	Grey - bulk
1067B	Bone
1067BQ	Bone - bulk

TANK LEVER - 45° FIT-ALL - AM-sTD



- 4 to 6" adjustable arm in chrome, white, grey and bone
- ABS plastic

PART#	DEsCRPTION
-------	------------

1063	Chrome
1063Q	Chrome - bulk
1063PB	Polished brass handle
1063W	White
1063WQ	White - bulk
1063g	Grey
1063gQ	Grey - bulk
1063B	Bone
1063BQ	Bone - bulk

TANK LEVER, LONG UNIVeRSAL



- Fits CRANE, AM-STD, and others
- 8" ABS plastic arm
- ABS handle

PART#	DEsCRPTION
-------	------------

1047	Chrome
1047Q	Chrome - bulk
1047W	White
1047WQ	White - bulk

TANK LEVERs

TANK LEVER - ABs HANDLE - BRAss ARM - AM-sTD

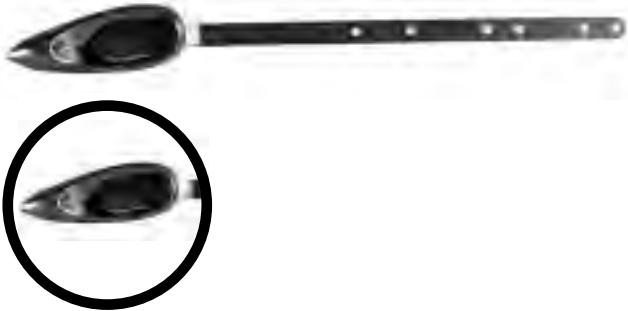

- Chrome and white available
- Plastic head AM-STD style
- Adjustable and bendable 8" brass arm

PART#	DEsCRIPtion
1052	Chrome
1052Q	Chrome - bulk
1052W	White
1052WQ	White - bulk

TANK LEVER - ABs HANDLE - BRAss ARM - AM-sTD NEW sTYLE



- AM-STD new style handle
- Chrome and White handle available
- Adjustable and bendable 8" brass arm

PART#	DEsCRIPtion
1057	Universal tank lever - chrome
1057W	Universal tank lever - white
1057WQ	Universal tank lever - white bulk
1057Q	Universal tank lever - chrome bulk

TANK LEVER - AM-sTD NEW sTYLE HANDLE



- Chrome, white and bone handle available
- Plastic arm for 4", 6" and 8" lengths

PART#	DEsCRIPtion
1053	Chrome
1053Q	Chrome - bulk
1053W	White
1053WQ	White - bulk
1053B	Bone
1053BQ	Bone - bulk

TANK LEVER - AM-sTD NEW sTYLE HANDLE 28°

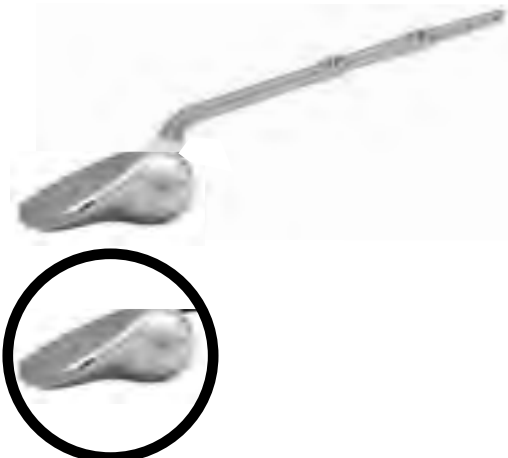

- Chrome, white and bone handle
- Plastic arm for 4" and 6" lengths available
- 28° arm

PART#	DEsCRIPtion
1081	Chrome
1081Q	Chrome - bulk
1081W	White
1081WQ	White - bulk
1081B	Bone
1081BQ	Bone - bulk

TOILET REPAIR

TANK LEVER - AM-STD NEW STYLE HANDLE, 45°



- Chrome, white and bone handle available
- Plastic arm for 4" and 6" lengths
- 45° arm

PART#	DESCRIPTION
1082	Chrome
1082Q	Chrome - bulk
1082W	White
1082WQ	White - bulk
1082B	Bone
1082BQ	Bone - bulk

TANK LEVER - ELJER



- 10" brass arm
- Die cast handle
- Plastic spud
- Plastic locknut
- Side mount

PART#	DESCRIPTION
1049	Chrome
1049Q	Chrome - bulk
1050	Polished brass handle

TANK LEVER - PUSH BUTTON AM-STD

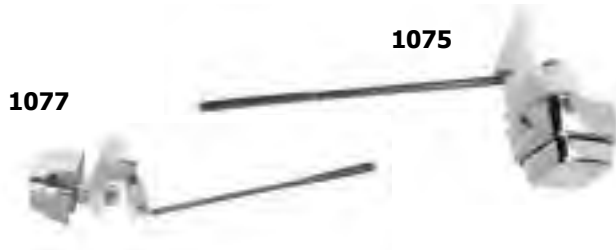

- Chrome plastic handle
- AM-STD, CRANE, KOHLER, ELJER
- Chrome finish
- Brass arm

PART#	DESCRIPTION
1075	Front push button
1077	Side push button

TANK LEVER - WELLWORTH II
KOHLER

- 8" Plastic arm
- Die cast handle, chrome
- Plastic spud
- Plastic locknut
- OEM ref#9386

PART#	DESCRIPTION
1051	Chrome
1051Q	Chrome - bulk

TOILET REPAIR

TANK LEVER - KOHLER SIDE MOUNT



- Brass handle in chrome, nickel, or oil rubbed bronze finishes
- Brass arm 7" long
- Can be used on MEMOIRS and DEVONSHIRE toilets
- For 2 piece toilets, side mount installation
- OEM ref#9439

PART#	DEsCRPTION
1083	Chrome
1083BN	Brushed nickel
1083ORB	Oil rubbed bronze

TANK LEVER - KOHLER FRONT MOUNT



- Brass handle in chrome, nickel, or oil rubbed bronze finishes
- Brass arm 7" long
- Can be used on DEVONSHIRE toilets
- For 1 piece toilets, front mount installation
- OEM ref#9462

PART#	DEsCRPTION
1084	Chrome
1084BN	Brushed nickel
1084ORB	Oil rubbed bronze

TANK LEVER - KOHLER FRONT MOUNT



- Brass handle in chrome, nickel, or oil rubbed bronze finishes
- Brass arm 6" long
- Can be used on CIMMERON toilets
- Left side, front mount installation
- OEM ref#9466

PART#	DEsCRPTION
1085	Chrome
1085BN	Brushed nickel
1085ORB	Oil rubbed bronze

TANK LEVER - KOHLER SIDE MOUNT



- Handle in chrome, nickel, or oil rubbed bronze finishes
- Brass arm 7" long
- Can be used on GABRILLE, SAN RAPHA and other toilets
- Side mount installation
- OEM ref#9464

PART#	DEsCRPTION
1086	Chrome
1086BN	Brushed nickel
1086ORB	Oil rubbed bronze

TANK LEVERs

TANK LEVER - TOTO

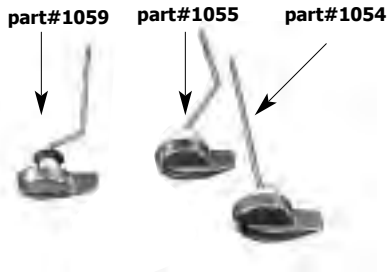

- 10" round brass arm
- CP Die cast handle (part# 1059 only)
- Plastic spud CP plastic handle
- Plastic locknut
- Side mount

PART#	HANDLE MATERIAL	DEsCRIPTION
1059	Metal	TOTO THU068
1054	Plastic	TOTO THU004
1055	Plastic	TOTO THU061

TANK LEVER - MANSFIELD



- Front mount tank lever
- Chrome handle, ABS
- Plastic 9" arm

PART#	DEsCRIPTION
1045	#41 & #42 New style C.P. plastic

TANK LEVER - MANSFIELD



- Old style lever
- Front mount handle, die cast metal
- Brass 10" arm

PART#	DEsCRIPTION
1065	#42 CP die cast handle, metal arm, old style

TANK LEVER - UNIVeRSAL

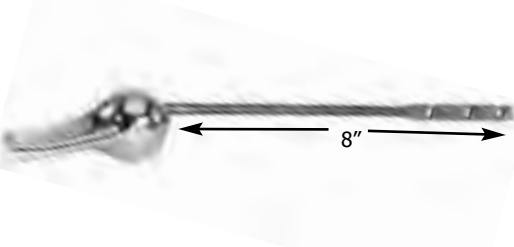

- LYNCAR'S most popular universal lever
- Die cast metal handle, chrome
- Brass arm 8"

PART#	DEsCRIPTION
1040	Chrome - die cast spud & nut
1040Q	Chrome - die cast spud & nut - bulk
1040PB	Polished brass handle

TANK LEVER - UNIVeRSAL PREMIUM

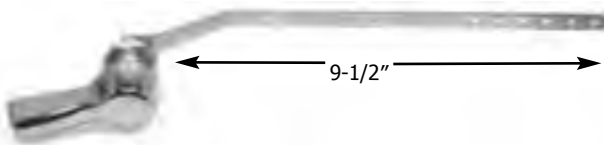

- Universal premium lever
- Die cast metal handle, chrome
- Brass arm 9-1/2" offset

PART#	DEsCRIPTION
1056	Offset premium tank lever

TANK LEVERs

C

TANK LEVER - OFFsET WEsTERN POTTERy



PART#	DEsCRIPTION
1058	WESTERN POTTERY tank lever

TANK LEVER - sURE-FIT FLUIDMAster



- 8" ABS plastic arm
- ABS plastic handle
- Retail carded

PART#	DEsCRIPTION
FM680	White #680C
FM681	Chrome #681C
FM682	Polished Brass #682C

PUsh-BUTTON TANK LEVERs



- Especially for side-mount tanks
- Easy to install
- Fits most AM-STD and UNIVERSAL-RUNDLE® brand toilets
- Available in Chrome Only

PART#	DEsCRIPTION
FM691	Push-Button tank levers

TOILET REPAIR

FLAPPERS

ACTUATOR FOR AMERICAN s STANDARD



PART#	REPLACES AMsTD	DEsCRIPTION
1038	#5	Low profile
1039	#6	High profile
1042	Repair kit with chain rubber grommet & clip	

ADJUsTABLE FLAPPER FOR AMERICAN s STANDARD



- Colour coded timed tips
- For a variety of flush rates

PART#	BULk PART#
10143	10143Q

BLACK RUBBER FLAPPER AMERICAN s STANDARD



- Premium rubber flapper
- Fits AM-STD toilets, CADET, PLEBE & others
- Steel chain

PART#	BULk PART#
1003	1003Q

3 WAY WITH FLOAT FOR AMERICAN s STANDARD



- 9" chrome plated brass chain
- Vinyl flapper with float
- OEM ref#738003-300

PART#	BULk PART#
10142	10142Q

FLAPPER - FOR AMERICAN s STANDARD ACTUATOR



PART#	BULk PART#	DEsCRIPTION
1035	1035Q	Combo Fit-All
1036	1036Q	Screw-On
1037	1037Q	Snap-On

FLAPPER - AMERICAN s STANDARD



- Oversized plastic flapper
- For CADET III
- Chemical resistant
- OEM ref#738920-007A

PART#	BULk PART#
1043	1043Q

FLAPPERS

TOILET REPAIR

FLAPPER - KORky FOR AM-sTD



- Replaces AM-STD No. 738920-0070P
- Five year guarantee, chlorine resistant

PART#	DEsCRIPtION
3040BP	KORKY flapper for AM-STD

FLAPPER - CRANE NEW sTyLE



- Premium rubber flapper
- Stainless steel chain
- Universal fit

PART#	BULk PART#
1005	1005Q

FLAPPER - OLD sTyLE CRANE



- Stainless steel chain
- Polystyrene float

PART#	BULk PART#
1004	1004Q

COAsT sTyLE "BLUE" FLAPPER



- The popular copy of the COAST style blue flapper
- Chemical resistant and is widely accepted in the industry

PART#	BULk PART#
10141	10141Q

COAsTMAsTER "BLUE" FLAPPER



- COASTMASTER'S popular blue flapper
- Chemical resistant and is widely accepted in the industry

PART#	BULk PART#
10090	10090Q

COAsTMAsTER "BLUE" FLAPPER WITH ChAIN



- COASTMASTER'S popular blue flapper
- Chemical resistant and is widely accepted in the industry
- Supplied with steel chain

PART#	BULk PART#
10092	10092Q

FLAPPERS

COAsTMAsTER "CERTAIN sEAL" FLAPPER



- Hard plastic flapper
- Stainless steel chain
- Pressure sensitive seal
- Fits AM-STD, KOHLER, TOTO
- CSA approved

PART# **DEsCRIPTION**

53316 Certain seal

FLAPPER ELjER



- White plastic
- Stainless steel chain
- Fits ELJER - LOW BOY, WINDSOR, CANTERBURY
- Styrofoam ball

PART# **DEsCRIPTION**

11345 ELJER plastic

TOILET REPAIR

TITAN FLAPPER, RED ELjER



- TITAN model
- Chlorine resistant
- KORKY design
- Replaces ELJER 495-6077-00

PART# **DEsCRIPTION**

10151 TITAN Red Flapper

TITAN FLAPPER, BLUE ELjER



- Blue
- Stainless steel chain
- Extra large flapper
- Replaces ELJER 495-6077-00

PART# **DEsCRIPTION**

10119 TITAN blue flapper

FLAPPER FRUgAL



Adjust - a - dial

- Designed to convert 3.6, 5 and 7 gallon per flush toilets into water saving toilets by reducing the amount of water per flush by 30 to 50%
- Adjustable water saving
- Fits most 3.5 gallon toilets

PART# **DEsCRIPTION**

1022 Box packaged

MANsFIELD FLAPPER



- Blue, oversized
- Stainless steel chain
- OEM ref#630-0206

PART# **DEsCRIPTION**

10122 Extra large flapper

FLAPPERS

TOILET REPAIR

FLAPPER - RUBBER KOHLER



- 8" chain
- Resistant to tank bowl cleaners
- Replaces KOHLER #49114

FLAPPER - KOHLER CIMMERON sTYLE



- Red
- Stainless steel chain
- Extra large flapper

PART#	DEsCRPTION
1031	LYNCAR black
1031Q	LYNCAR black - bulk
10154	KORKY red

PART#	DEsCRPTION
10120	KORKY KOHLER Cimmeron

KOHLER CLAsS 5 sTYLE FLAPPER



- Red
- Stainless steel chain
- Extra large flapper

KORky 2010 FITs KOHLER RIALTO FLAPPER



- Fits specific KOHLER one-piece toilets
- Premium red Chlorazone rubber resists chlorine
- Embedded styrofoam float
- Replaces KOHLER #83064

PART#	DEsCRPTION
10158	Red KORKY model, Class 5
10121	Red LYNCAR model, Class 5

PART#	DEsCRPTION
10155	KORKY KOHLER

KORky 2011 FITs KOHLER hINGE FLAPPER



- Fits specific KOHLER one-piece toilets
- Premium red Chlorazone rubber resists chlorine
- Flapper hinges onto back of flush valve
- Replaces KOHLER #84995 & #1000490

KORky 2010 FITs KOHLER shARK FIN FLAPPER



- Fits specific KOHLER one-piece toilets
- Premium red Chlorazone rubber
- Resists chlorine
- Replaces KOHLER #84318, #84314, #85655 and #89825

PART#	DEsCRPTION
10156	KORKY KOHLER Hinge

PART#	DEsCRPTION
10157	KORKY KOHLER Shark Fin

FLAPPERS

kORky FLAPPER - 54



- Blister packed
- Preferred by plumbers for superior quality and reliability since 1954
- Universal replacement flapper

PART# **DEsCRIPtION**

54 KORKY 54

kORky PLUs FLAPPER - 2001



- Chlorazone red rubber
- Resists chlorine
- Universal design fits both brass and plastic flush valves

PART# **DEsCRIPtION**

55 KORKY 2001

kORky PLUs 6L FLAPPER 16



- Premium red Chlorazone rubber
- Designed for newer (since 1995) 1.6 gallon toilets
- Resists chlorine
- Saves up to 50% more water in standard toilets (older than 1995)
- Five year guarantee

PART# **DEsCRIPtION**

16 KORKY 6L Flapper

kORky PLUs ADjUsTABLE TOILET TANK FLAPPER



- Made from Chlorazone
- Easily adjusts to save water or a bigger flush
- Fits most brands
- 5 year guarantee

PART# **DEsCRIPtION**

51 KORKY PLUS

kORky CLAssIC



- Original design for brass flush valves
- For older, 5 and 7 g.p.f. toilets
- Also available in premium red Chlorazone rubber

PART# **DEsCRIPtION**

50 KORKY CLASSIC

kORky MAXFLUsh



- Fits slanted plastic flush valves
- Stays open longer for maximum flush
- Specially designed for low boy style toilets

PART# **DEsCRIPtION**

92 KORKY MAXFLUSH

FLAPPERS

TOILET REPAIR

KORky® 525BP FLAPPER



- Made of durable vinyl
- Easy to install, prevents leaks
- Fits most two piece toilets
- Tangle free lift strap
- Fits CRANE brass and plastic flush valves

KORky CLAssIC ChLORAZONE



- Premium red Chlorazone rubber
- Original design for brass flush valves
- For older, 5 and 7 g.p.f. toilets

PART#	DEsCRPTION
10126	KORKY 525 flapper

PART#	DEsCRPTION
50CR	KORKY CLASSIC, Chlorazone red, 2000BP

FITs TOTO® g-MAX™ FLAPPER



- Authorized replacement flapper for TOTO G-MAX toilets, or Non OEM models
- 3" sealing surface for larger TOTO flush valve seats
- Red in colour
- Resists chlorine
- Five year guarantee
- Non OEM model also available

TOTO® - POWER gRAVITY



- Authorized replacement flapper for TOTO power gravity toilets, or Non OEM models
- 3" sealing surface for larger TOTO flush valve seats
- Blue in colour
- Resists chlorine
- Five year guarantee
- Non OEM model also available

PART#	DEsCRPTION
10131	KORKY OEM

PART#	DEsCRPTION
10130	KORKY OEM

kOhLER TANK TO BOWL gAskET



- Fits most 2 pc KOHLER toilets
- Includes 3 brass bolts with washers and nuts
- KOHLER triangle gasket
- OEM ref#51487

KORky® LARgE 3 INCh ADJUsTABLE FLAPPER



- Adjusts to fit all 3 inch toilets
- Universal design fits large 3 inch flush valves
- Adjusts to match performance of OEM flapper
- Five year guarantee

PART#	DEsCRPTION
3001	KOHLER gasket

PART#	DEsCRPTION
3060BP	Universal 3" fit flapper

UNIvERsAL FLAPPERs

FITs TOTO® g-MAX™ FLAPPER



- 3" sealing surface for larger TOTO flush valve seats
- Red in colour
- Resists chlorine
- Five year guarantee

TOTO® - POWER gRAvITy



- 3" sealing surface for larger TOTO flush valve seats
- Blue in colour
- Resists chlorine
- Five year guarantee

PART#	DEsCRIPTION
10124	Non OEM, LYNCAR brand

PART#	DEsCRIPTION
10123	Non OEM, LYNCAR brand

PLAsTIC ADJUsTABLE



- Adjustable flapper
- Blue plastic body
- Seal washer
- Steel chain
- Fits AM-STD/ KOHLER/ TOTO

UNIvERsAL RUBBER FLAPPER



- Premium grade rubber
- Universal
- Steel chain

PART#	DEsCRIPTION
10140	Plastic adjustable flapper

PART#	BULk PART#
1028	1028Q

TANK BALL



- Water saver
- 1 per box

UNIvERsAL vINyL FLAPPER



- Vinyl flapper
- Universal
- Steel chain

PART#	DEsCRIPTION
1032	Tank Ball

PART#	BULk PART#
10144	10144Q

TOILET REPAIR

FLUsh vALvEs

FLUsh vALvE - DOUgLAS, BRAss



- Rubber washer
- Solid ring guide
- Locknut overflow tube

PART#	DEsCRPTION
1027	Brass flush valve with brass nut

FLUsh vALvE - DOUgLAS, PLAsTIC



- White plastic
- Steel chain
- Rubber flapper
- Valve gasket
- Fits AM-STD / CRANE and others

PART#	DEsCRPTION
1029	Flush valve plastic
1029Q	Flush valve plastic - bulk

MANsFIELD # 210/211 sTyLE FLUsh vALvE



- For 3.5 gallon tank
- 10-3/4" length

PART#	DEsCRPTION
10210	Full flush
10211	Water saver 1.6 gallon flush

FLUsh vALvE ADjUsTABLE



- Adjustable overflow tube
- Adjusts from 6" to 11"
- Rubber flapper
- Fits AM-STD / KOHLER / ELJER / CRANE and others

PART#	DEsCRPTION
10299	Flush valve adjustable
10299Q	Flush valve adjustable - bulk

TOILET REPAIR

FLUsh vALvE 2" ABs



- Flapper flush valve 2"
- ABS material, premium quality
- Adjustable overflow tube
- ABS flapper with silicone seal
- cUPC approved

PART#	DEsCRPTION
1020	Flush valve
1020Q	Flush valve - bulk

FLUsh vALvE 3" ABs



- Flapper flush valve 3"
- ABS material, premium quality
- Adjustable overflow tube
- ABS flapper with silicone seal
- cUPC approved

PART#	DEsCRPTION
1021	Flush valve
1021Q	Flush valve - bulk

kORky 2" TOP MOUNT FLUsh vALvE #723X



- With flapper for 1 pc toilets
- Fits 2" one-piece toilets, including AMERICAN STANDARD®
- 7.5" overflow tube height
- Easy to install (installation driver included)
- Engineered materials resist chlorine
- Five year guarantee
- cUPC approved

PART#	DEsCRPTION
10145	Flush valve

FLUsh vALvE CONvERTER



- Converts older 1.6 gpf toilets to a powerful 3" flush
- Telescoping overflow tube
- KOHLER Class 5 flapper
- Flush valve seal, nut, and recessed sponge gasket
- Tank to bowl balancing washers
- Replace most popular 2" flush valves

PART#	DEsCRPTION
1016	Flush valve converter

TOILET REPAIR

FAUCET REPAIR

MINI PILOT BALLCOCK



- Anti-siphon
- One piece design
- No need for rod or float
- Refill tube, nut & washers included
- Operates below water level

PART#	DEsCRPTION
10093	Replaces old style ballcocks

DUAL FLUsh TOILET kIT



- Easy to install
- Fits most front and side
- Save water on every flush
- Push button dual flush
- cUPC approved

PART#	DEsCRPTION
10078	Dual flush toilet kit

TOILET REPAIR

FILL & DUAL FLUsh vALvE



- Converts your existing toilet to Dual Flush Technology
- Uses up to 45% less water
- Automatically save water and delivers precise and powerful flushing action
- Fully adjustable for a wide range of applications
- Complete system included

PART#	DEsCRPTION
FMs2DBL	FLUIDMASTER Dual Flush Kit

TOTO REPLACEMENT FILL vALvE FROM kORky



- Proven quietest
- 5 year guarantee
- OEM for TOTO
- Easiest to install... No tools required!
- Resists chemicals and toilet tank cleaners
- Retail Packaged
- Replaces TOTO Power Gravity & G-Max Fill Valves
- CSA approved

PART#	DEsCRPTION
10129	#528T Fill valve

TOILET REPAIR

KORky® QUIETFILL FILL vALvE



- Proven quietest
- 5 year guarantee
- Fits all brands
- Easiest to install... No tools required!
- Resists chemicals and toilet tank cleaners

PART#	DEsCRPTION
10125	#528CF QUIETFILL
10127	Repair Kit #528CF BALLCOCK

KORky® UNIVeRSAL TOILET REPAIR KIT



- Fix your leaking, noisy, or running toilet in 1 trip
- Kit includes: fill valve, flush valve, KORky PLUS flapper, tank-to-bowl gasket, nuts, bolts and washers

PART#	DEsCRPTION
10133	Toilet repair kit

KORky® ADJUsTABLE FLUsh vALvE & FLAPPER



- Universal design, fits most 2 piece toilet tanks
- Height easily adjusts from 7" to 11-1/2"
- Oversized tube and funnel reduce flood risk

PART#	DEsCRPTION
10132	KORky flush valve

FLUIDMASTER BALLCOCKS

TOILET REPAIR

400A



- Anti-siphon ballcock
- Adjustable 9" to 14"
- Retail packaged
- CSA approved OEM

400Ls



- Leak sentry ballcock
- Prevent endless, automatic refilling of leaky tanks.
- Adjustable 9" to 14"
- Retail packaged
- CSA approved

PART# DEsCRIPtION

FM400A Anti-siphon ballcock

PART# DEsCRIPtION

FM400Ls Leak sentry ballcock

400C



- All you need in one kit to fix the most common leaks and squeaks
- Features the proven 400A Fill Valve and the rugged BULL'S EYE® Super Flapper (501)
- Flapper is chlorine-resistant for harsh water regions
- CSA approved

BULL'S EYE FLAPPER



- Basic repair for average conditions
- Replaces old tank ball or worn flapper
- Easy to install, fits most tanks
- Hinged to a rigid frame for better alignment

PART# DEsCRIPtION

FM400C 400C ballcock with flapper

PART# DEsCRIPtION

FM500 Bullseye flapper

FLUsh ER FIXER KIT



- Includes new drain seat for repairing older, corroded tank drains
- Fits most tanks
- Adjustable timing cup for most efficient flush
- Chlorine-resistant flapper for harsh water regions
- Five-Year Warranty

MANsFIELD FLUsh vALvE sEAL



- Seal for # 210 / 211 MANSFIELD
- Flush Valve

PART# DEsCRIPtION

FM555C Flusher fixer kit

PART# DEsCRIPtION

10212 MANSFIELD flush valve seal

TOILET REPAIR

COAsT 1B1 sTyLE 10" FILL vALvE



- One piece design
- Rod, refill tube, nut & washers included
- OEM ref#12114
- CSA approved



PART#	DEsCRIPTION
-------	-------------

10213	10" fill valve
-------	----------------

COAsT 1B1X sTyLE FILL vALvE



- Fits most one piece toilets
- Retail packaged
- One piece design
- Rod, refill tube, nut & washers included
- OEM ref#10174
- CSA approved



PART#	DEsCRIPTION
-------	-------------

10214	1B1X style fill valve
-------	-----------------------

1B1X CONvERsION kIT, FOR kOhLER TOILETs



- Conversion kit for KOHLER using a COASTMASTER or COAST 1B1X ballcock (not included)
- For one piece toilets
- Includes front rim diverter and tube
- For use with LynCar **part#10214 (above)** or COASTMASTER 10084X (OEM) (**page C-24**)
- Compare to KOHLER OEM ref#84499

PART#	DEsCRIPTION
-------	-------------

10230	Conversion kit only
-------	---------------------

10231	Kit with LYNCAR part#10214 COAST 1B1X fill valve (page C-22)
-------	--

10232	Kit with COASTMASTER (OEM) 1B1X fill valve (page C-24)
-------	---

MANsFIELD sTyLE 10" FILL vALvE



- One piece design
- Rod, refill tube, nut & washers included
- OEM ref#07
- CSA approved



PART#	DEsCRIPTION
-------	-------------

10215	10" fill valve
-------	----------------

hOOvER sTyLE ANTI-sIPhON BALLCOCK



- Reliable
- Quiet operation
- CSA approved



PART#	DEsCRIPTION
-------	-------------

10082	8-1/2" ballcock complete w/ float rod , "s" clip, tube , CSA
-------	--

10102	10" ballcock complete w/ float rod, "s" clip, tube, CSA
-------	---

10112	12" ballcock complete w/ float rod, "s" clip, tube
-------	--

10079	9" - 13" adjustable hoover style ballcock
-------	---

TOILET REPAIR

TOILET REPAIR

COAsTMAsTER 1B1 FILL vALvE



- Retail packaged
- One piece design
- Rod, refill tube, nut & washers included
- **Part#10084** OEM ref#12114
- **Part#10085** OEM ref#12164
- CSA approved

PART#	DEsCRPTION
10084	10"
10085	12"

COAsTMAsTER FIT ALL FILL vALvE



- Retail packaged
- One size fits all tanks
- Rod, refill tube, nut & washers included
- OEM ref#12704
- CSA approved

PART#	DEsCRPTION
10086	FIT ALL

COAsTMAsTER MARK Iv FILL vALvE



- Retail packaged
- One piece design
- Rod, refill tube, nut & washers included
- OEM ref#13364
- CSA approved

PART#	DEsCRPTION
10087	12"

LyNCAR's ANTI-sIPhON FILL vALvE



- Universal replacement fill valve
- Quiet design
- Height adjustable 8" to 13"
- Colour display box packaged
- cUPC and ASSE approved

PART#	DEsCRPTION
10400	Adjustable anti-siphon valve

BALLCOCKs & TANK REPAIR PARTs



COAsTMAsTER 1B1 ADjUsTABLE



- Retail packaged
- 9-1/2" to 13"
- One piece design
- Rod, refill tube, nut & washers included
- OEM ref#14044
- CSA approved

PART#	DEsCRIPTION
10088	FIT ALL



COAsTMAsTER 1B1X FILL vALvE



- Fits most one piece toilets
- Retail packaged
- One piece design
- Rod, refill tube, nut & washers included
- OEM ref#10174
- CSA approved

PART#	DEsCRIPTION
10084X	1B1X fill valve
10084XT	Top only replacement for 1B1X fill valve

COAsTMAsTER 1B1 REPAIR kIT



10088RK



10084XRK



10084XTA

- Repair kits include: one seal ring, one complete piston assembly
- Top assembly includes screws

PART#	DEsCRIPTION
10088rk	For 1B1 fill valve
10084XRk	For 1B1X fill valve
10084XTA	1B1X top assembly

TOILET REPAIR

TANK LIDs - hIgh IMPACT PLAsTIC



- LYNCAR'S replacement toilet tank lids are an inexpensive way to replace a lost or broken lid
- White in colour and can be painted to match any coloured toilet
- Individually boxed

PART#	DEsCRIPTION	sIZE
10223	Universal Fit	22-3/4" x 8-3/4"

TOILET COvER shOE



- White plastic 13" x 23-1/2" overall size
- Caulk & seal design, fits all toilets including round & square front toilets
- Use when converting to low flush toilet from full flush
- Saves replacing the floor tiles
- Covers unsightly stains from old toilet base
- 13" x 23-1/2"

PART#	DEsCRIPTION
1012	1.6 conversion cover plate

sLOAN FLUshMATE sTyLE CARTRIDg E



- Quality non-OEM replacement
- Fits all FLUSHMATE 2 piece toilets
- American manufactured
- Bagged with instructions
- 100% individually tested
- FLUSHMATE cartridge OEM ref# C100500K
- Easy out tool OEM ref# ST1500

PART#	DEsCRIPTION
10137	FLUSHMATE cartridge
10138	Easy out tool

TOILET REPAIR

TOILET sTABILIZER sHIMs



- Available in soft or hard plastic
- 1-1/4" x 2" to 1/4" thick

PART#	DEsCRIPTION
234	10 per bag - standard (soft)
234Q	100 per bag - standard (soft)
234h	10 per bag - standard (hard)
234hQ	100 per bag - standard (hard)

BALLCOCK REPAIR PARTs



10081 2099 1015N

PART#	DEsCRIPTION
1015N	(New Style) bonnet, arm , diaphragm & screw
1017	Plastic refill tube
10081	"S" clip for refill tube (100 per package)
2099	Rubber shank washer

TANK OvERFLOW TUBE - BRAss



- 10" Brass tube
- Fine thread, one end

PART#	DEsCRIPTION
870	1" x 10"

BALLCOCK COUPLING NUT



PART#	DEsCRIPTION
1320	Plastic
1321	Brass

TANK FLOAT RODs - BRAss



- 20 TPI
- # 882 8" most popular

PART#	DEsCRIPTION
882	8" long
883	9" long
884	10" long
886	12" long

PLAsTIC FLOATs



- Plastic 4" x 5" oval float

PART#	DEsCRIPTION
1073	Plastic floats

TOILET REPAIR

WAX gAskET WITH hORN



- Premium made wax with horn
- For 3" or 4" closet rings
- Box packaged

WAX gAskET



- Premium made wax
- Box packaged

PART#	DEsCRIPTION
270	Wax gasket with horn

PART#	DEsCRIPTION
268	Wax gasket less horn

WAX gAskET jUMBO WITH hORN



- Supersized wax ring with horn
- Extra long horn
- Box packaged

LyNCAR MAXIMUM WAX gAskET WITH hORN



REINFORCED

- Felt reinforced wax ring with horn
- Forms a gas & water tight seal
- Maximum seal
- Professional Duty
- Box packaged

PART#	DEsCRIPTION
272	Flex-a-flange, jumbo

PART#	DEsCRIPTION
274	Reinforced wax seal

sPONGE RUBBER FLANgE gAskET



- Black
- 3-1/2" ID x 5-3/8" OD
- Resists mold, mildew and fungus

RED POLy FLANgE gAskET



- Red clay colour
- Made of Polyurethane foam

PART#	DEsCRIPTION
2229	1/2" thick
2230	3/4" thick
2228	1" thick

PART#	DEsCRIPTION
2051	1/2" thick
2052	3/4" thick
2053	1" thick

TOILET REPAIR

FLANGe EXTENSION KIT



- Kit Contains:
3 Self-sealing extenders
With 1/4" x 3-1/2" closet bolts, nuts & washers

PART#	DEsCRIPTION
1018k	Flange extension kit

FLANGe EXTENSION RINGs



- 1/4" thick

PART#	DEsCRIPTION
1018	Durable ABS

4 hOLE PATTERN ABs TOILET FLOOR FLANGe



- Fits 3" inside pipe ABS or PVC
- WC cheater flange
- Made from ABS plastic

PART#	DEsCRIPTION
8024	ABS toilet floor flange

4 hOLE PATTERN BRAss FLOOR FLANGe

(Heavy Duty Shown)



PART#	DEsCRIPTION
10134	Light duty
10135	Medium duty
10136	Heavy duty reducing 4" x 3"

FLANGe - CLOsET REPLACEMENT - 3"



- Compression o-ring joint
- Two o-ring diameters to accommodate different inside pipe diameters
- No need to remove lead joint, no tearing up floors
- No caulking lead joints
- Slides inside 3" cast iron
- Also fits Sch 30 and Sch 40 ABS & PVC
- Simply engage o-ring for snug fit, align bolt slots with proper toilet position and push into pipe for compression seal
- Secure flange to floor for proper installation

PART#	DEsCRIPTION
20020	Flange Closet Replacement

ADjUsTABLE ABs sTREET FLANGe - 3"



- Fits inside 3" Sch 40 pipe
- Ideal for concrete construction
- Eliminate need for chipping and chiseling concrete
- Makes repair jobs faster and easier
- Has extended length to reach riser below floor height

PART#	DEsCRIPTION
20022	Allowing up to 3" of adjustment to riser

TOILET REPAIR

TOILET REPAIR

QUICK RING REPAIR FLANGES



- Unique screw tabs attach to wood or concrete
- Platisol coat provides corrosion protection
- Slotted for 1/4" or 5/16" closet bolt
- Old closet ring does not need to be present
- Replaces any and all closet rings.
- For solvent welded steel / plastic combo and plastic closet rings
- Remove portion of broken ring, if remaining portion cannot be removed, Quick Ring will mount on top
- Apply a bead of butyl rubber caulk to the underside of the Quick Ring that will mount on top of the old ring
- Set Quick Ring on top of remaining portion of old ring
- Note location of old toilet bolt slots
- The length of the bolt slots in the Quick Ring allows for some centering of toilet. Secure the Quick Ring to wood or concrete sub floor with screws or anchors

PART#	DEsCRPTION
21013	Quick ring flange WITH tabs
21017	Quick ring flange LESS tabs

QUICK RING FIX FLANGE & hALF ANChOR

part#21015



part#21014



- Eliminate the need to replace broken closet flanges, saving time and money. Simply place the flange under the broken area of the ring and tighten the nut
- Suitable for use with cast iron, plastic, copper and brass closet flanges
- Packaged for retail display

PART#	DEsCRPTION
21015	Quick ring fix flange
21014	Quick ring half anchor flange

TOILET REPAIR

PIPEs NAP COvER



- Chrome plated plastic
- Splits open to wrap around copper or pex pipe
- Give you a chrome plated look
- Easy to cut to size needed
- 8" long strips

PART#	DEsCRPTION
1273	5 pack carded
1273Q	bulk 25 pack

ChROME BRAss, COvER TUBE



- Chrome plated brass pipe
- Goes over copper / PEX pipe
- Gives you a Chrome brass finish
- 5/8 OD x 3-1/2" long

PART#	DEsCRPTION
8489	Chrome brass cover tube

QUICK RING FLOOR REPAIR PLATE



- Easy to use floor and flange support
- Extends the anchoring surface
- Hardware included
- 9-1/4" x 7-1/8" coverage under toilet
- Display packaged

PART#	DEsCRPTION
21016	Floor repair plate

AMERICAN STANDARD

SINGLE LEVER HANDLE 3-1/4" FOR KITCHEN



- AQUARIAN ONE small
- 3-1/4" for kitchen
- OEM ref#77033-02

SINGLE LEVER HANDLE FOR LAVATORY



- AQUARIAN ONE large
- 4-7/8" for lavatory
- OEM ref#77031-02

PART#	BULK PART#	DESCRIPTION
7070	7070Q	AQUARIAN ONE small - for kitchen

PART#	BULK PART#	DESCRIPTION
7071	7071Q	AQUARIAN ONE large - for lav

SINGLE LEVER HANDLE



- AQUARIAN TWO small
- 3-1/4" for small
- OEM ref#70545-02

SINGLE LEVER HANDLE



- AQUARIAN TWO large
- 5-1/2" large
- OEM ref#37982-02

PART#	BULK PART#	DESCRIPTION
7072	7072Q	AQUARIAN TWO small

PART#	BULK PART#	DESCRIPTION
7073	7073Q	AQUARIAN TWO large

HERITAGE LEVER DOME HANDLE



- Hot / cold pair
- For kitchen & lavatory
- 1-5/16" height

WRIST BLADE HANDLE



- Hot / cold pair
- For service sink
- 4-1/2" long

PART#	BULK PART#	DESCRIPTION
7081	7081Q	For kitchen & lavatory

PART#	BULK PART#	DESCRIPTION
7082	7082Q	For service sink

AQUASEAL CARTRIDGES



- Hot OEM ref#G72950-17
- Cold OEM ref#G72951-17
- Diaphragm OEM ref#G72940-07
- Seat OEM ref#861-14

HERITAGE HANDLES DIE CAST METAL



- Hot / cold pair
- Small OEM ref#6458-021
- Large OEM ref#6459-0221
- Widespread OEM ref#6459-021

PART#	BULK PART#	DESCRIPTION
2031	2031Q	AQUASEAL hot
2032	2032Q	AQUASEAL cold
2033	2033Q	Diaphragm washer
2034	2034Q	Seat 7/16" x 24TPI

PART#	BULK PART#	DESCRIPTION
7076	7076Q	Small 1-9/16" short broach
7077	7077Q	Large 1-5/8 long broach T&S
7078	7078Q	Diverter 1-5/8 long broach
7079	7079Q	Widespread 1-5/8"

OEM (Original Equipment Manufacturer) numbers, registered / non registered trademarks, faucet name, and manufacturer listed above are supplied and listed for your reference only. All LynCar items are precision made and tested to the highest standards, by qualified factories inspected and approved by LynCar.

FAUCET REPAIR

BRADLEY / CHICAGO

BRADLEY BRAD-TROL CARTRIDGE DIVERTER



- OEM ref#300-0050

PART#	BULK PART#	DESCRIPTION
9009	9009Q	Cartridge diverter

BRADLEY BRAD-TROL CARTRIDGE



- Supplied with seat
- Hot OEM ref#400-08190
- Cold OEM ref#400-08290

PART#	BULK PART#	DESCRIPTION
9012	9012Q	Hot
9013	9013Q	Cold

CHICAGO - QUATURN CARTRIDGES NEW STYLE



- Exposed cap
- Hot OEM ref#1-100XK
- Cold OEM ref#1-99-XK

PART#	BULK PART#	DESCRIPTION
9016	9016Q	Hot
9017	9017Q	Cold

CHICAGO - QUATURN LEVER HANDLES



- Hot / cold pair
- For faucet sink

PART#	BULK PART#	DESCRIPTION
9018	9018Q	Pair lever

OEM (Original Equipment Manufacturer) numbers, registered / non registered trademarks, faucet name, and manufacturer listed above are supplied and listed for your reference only. All LynCar items are precision made and tested to the highest standards, by qualified factories inspected and approved by LynCar.

CRANE

CRANE 5 RIB HANDLES



- Hot / cold pair
- Metal handle
- Small OEM ref#355151
- Medium OEM ref#355154
- Large OEM ref#355157

PART#	BULK PART#	DESCRIPTION
931	931Q	Small 1-1/4" height
932	932Q	Medium 1-1/2" height
933	933Q	Large 1-3/4" height

CRANE ACRYLIC HANDLES



- Hot / cold pair
- Small OEM ref#355374
- Medium OEM ref#355384
- Large OEM ref#355371

PART#	BULK PART#	DESCRIPTION
934	931Q	Small 1-1/2" height
935	932Q	Medium 1-5/8" height
936	933Q	Large 1-3/4" height

CRANE CAMEO HANDLES



- Hot / cold pair
- 3 rib style
- Small OEM ref#355556
- Large OEM ref#355558

PART#	BULK PART#	DESCRIPTION
2020	2020Q	Small 1-5/16 height
2021	2021Q	Large 1-3/4 height

CRANE INDEX BUTTONS



- For 5 rib style handles
- Small hot / cold pair OEM ref#3300877 / 78
- Medium hot / cold pair OEM ref#300880 / 81
- Large hot / cold pair OEM ref#301918 / 19

PART#	BULK PART#	DESCRIPTION
12626	12626Q	Small hot / cold pair 13/16"
12627	12627Q	Medium hot / cold pair 15/16"
12628	12628Q	Large hot / cold pair 13/16"

OEM (Original Equipment Manufacturer) numbers, registered / non registered trademarks, faucet name, and manufacturer listed above are supplied and listed for your reference only. All LynCar items are precision made and tested to the highest standards, by qualified factories inspected and approved by LynCar.

CRANE

CRANE DIALESE CARTRIDGE



- Hot or cold cartridge
- OEM ref#354001, 354002

PART#	BULK PART#	DESCRIPTION
907	907Q	Hot cartridge
908	908Q	Cold cartridge

CRANE DIALESE STEM REPLACEMENT



- Replacement stem only
- OEM ref#300107, 300108

PART#	BULK PART#	DESCRIPTION
916	916Q	Hot stem only
917	917Q	Cold stem only

CRANE CAMEO CARTRIDGE



- Hot or cold cartridge
- For CAMEO
- OEM ref#355160

PART#	BULK PART#	DESCRIPTION
918	918Q	Fits hot and cold

CRANE SEATS



- CRANE CAMEO seat OEM ref#301705
- CRANE CAMEO T/S seat

PART#	BULK PART#	DESCRIPTION
11197	11197Q	CAMEO Seat 9/16 x 18 TPI
11196	11196Q	CRANE T/S extended seat 1/2 x 18 TPI x 2 3/4" long

OEM (Original Equipment Manufacturer) numbers, registered / non registered trademarks, faucet name, and manufacturer listed above are supplied and listed for your reference only. All LynCar items are precision made and tested to the highest standards, by qualified factories inspected and approved by LynCar.

CRANE

CRANE WASHER



- Bottom Washer for DIALESE
- 1 pair of washers or bulk pack of 25 pieces

PART#	BULK PART#	DESCRIPTION
12623	12623Q	CRANE washer

CRANE CORK WASHER



- Washer for DIALESE
- Bulk pack 25 pieces

PART#	DESCRIPTION
12622	Bulk pack 25 pieces

CRANE DIALESE REPAIR KITS



- 1 kit or bulk pack 25 kits

PART#	BULK PART#	DESCRIPTION
908R	908RQ	Repair kit

OEM (Original Equipment Manufacturer) numbers, registered / non registered trademarks, faucet name, and manufacturer listed above are supplied and listed for your reference only. All LynCar items are precision made and tested to the highest standards, by qualified factories inspected and approved by LynCar.

CUTHBERT & BELANGER

CUTHBERT NOVA HANDLE



- Hot / cold pair
- Also fits BELANGER
- 1-1/2" height

BELANGER CHROME PLATED DIE CAST HANDLE



- Hot / cold pair
- 1-1/2" height

PART#	BULK PART#	DESCRIPTION
937	937Q	Hot / cold pair

PART#	BULK PART#	DESCRIPTION
881	881Q	Hot / cold pair

CUTHBERT C2 CARTRIDGE



- Lavatory & kitchen
- Fits hot & cold

CUTHBERT M2 CARTRIDGE



- Lavatory & kitchen

PART#	BULK PART#	DESCRIPTION
904	904Q	Hot / cold cartridge

PART#	BULK PART#	DESCRIPTION
909	909Q	M2 cartridge

CUTHBERT M3 CARTRIDGE



- Tub & shower

CUTHBERT / BELANGER SEATS



- 1/2 x 20 tpi seat CUTHBERT
- OEM ref#0054
- 9/16 x 24 tpi seat CUTHBERT BELANGER
- OEM ref#0057A

PART#	BULK PART#	DESCRIPTION
897	897Q	M3 cartridge

PART#	BULK PART#	DESCRIPTION
12824	12824Q	1/2 x 20 tpi
12825	12825Q	9/16 x 24 tpi

OEM (Original Equipment Manufacturer) numbers, registered / non registered trademarks, faucet name, and manufacturer listed above are supplied and listed for your reference only. All LynCar items are precision made and tested to the highest standards, by qualified factories inspected and approved by LynCar.

CUTHBERT

CUTHBERT DIVERTER



- Tub and shower diverter
- OEM ref#1268-41

PART#	BULK PART#	DESCRIPTION
898	898Q	Diverter

CUTHBERT DIVERTER



- Tub and shower diverter
- OEM ref#FC91268-41

PART#	BULK PART#	DESCRIPTION
888	888Q	Diverter

CUTHBERT / BELANGER



- Tub and shower diverter
- Assembly for built in models
- OEM ref#1960-5A

PART#	BULK PART#	DESCRIPTION
887	887Q	Diverter

FAUCET REPAIR

OEM (Original Equipment Manufacturer) numbers, registered / non registered trademarks, faucet name, and manufacturer listed above are supplied and listed for your reference only. All LynCar items are precision made and tested to the highest standards, by qualified factories inspected and approved by LynCar.

DANFOSS TEMPRESS

DANFOSS TEMPRESS II SHOWER ESCUTCHEON



- Replacement shower escutcheon for DANFOSS TEMPRESS II
- Chrome plated
- 7-1/8" diameter

PART#	DESCRIPTION
9120	Escutcheon plate

PRESSURE BALANCE CARTRIDGE WITH O RING



- Fits DANFOSS TEMPRESS II (OEM ref#062N1285) GROHE (OEM ref#6-3301-5-4), VALLEY, EMCO and POWERS
- Pressure balance cartridge

PART#	BULK PART#	DESCRIPTION
922	922Q	Cartridge

DANFOSS TEMPRESS II CHROME HANDLE & CAP



- Handle and cap for DANFOSS TEMPRESS II chrome plated handle and snap in black cap
- Cap OEM ref# 062N0375
- Handle OEM ref# 062N0250
- Chrome plastic
- Extender included (LynCar part#922E)

PART#	BULK PART#	DESCRIPTION
9119	9119Q	Chrome plated plastic handle

DANFOSS / EMCO TEMPRESS STEM EXTENDER



- DANFOSS pressure balance faucet handle stem adapter

PART#	BULK PART#	DESCRIPTION
922E	922EQ	Stem extender

OEM (Original Equipment Manufacturer) numbers, registered / non registered trademarks, faucet name, and manufacturer listed above are supplied and listed for your reference only. All LynCar items are precision made and tested to the highest standards, by qualified factories inspected and approved by LynCar.

DELTA

DELTA CANOPY HANDLES



- Hot / cold pair
- Fits DELTA & PEERLESS
- OEM ref#RP6062
- 1-3/4" height

PART#	BULK PART#	DESCRIPTION
2022	2022Q	Hot / cold pair

DELTA CRYSTAL HANDLES OLD STYLE



- Hot / cold pair
- Tub & shower height 2-5/16"
- Lavatory & kitchen height 1-7/8"
- OEM ref#RP5693

PART#	BULK PART#	DESCRIPTION
2023	2023Q	Tub & shower
2030	2030Q	Lav & kitchen

DELTA / DELEX WIDESPREAD HANDLE



- Hot / cold pair
- For lavatory, kitchen, tub and shower
- Lavatory height 2"
- OEM ref#RP17449

PART#	BULK PART#	DESCRIPTION
13005	13005Q	Widespread

FAUCET REPAIR

OEM (Original Equipment Manufacturer) numbers, registered / non registered trademarks, faucet name, and manufacturer listed above are supplied and listed for your reference only. All LynCar items are precision made and tested to the highest standards, by qualified factories inspected and approved by LynCar.

DELTA

DELTA TUB AND SHOWER HANDLE



- Single acrylic handle
- Fits #70 ball faucets
- Metal adapter insert
- 1-3/4" diameter x 2-1/4" tall

PART#	BULK PART#	DESCRIPTION
13002	13002Q	Handle

DELTA ACRYLIC HANDLES



- Single acrylic handle
- Lavatory height 2" OEM ref#RP2389
- Tub & shower height 2-1/8" OEM ref#RP2391
- Scaldguard height 2-1/4" OEM ref#RP2392

PART#	BULK PART#	DESCRIPTION
13011	13011Q	Lavatory
13009	13009Q	Tub & shower
13007	13007Q	Scaldguard

DELTA LEVER FAUCET HANDLE



- Single die cast metal handle, chrome
- Fits DELTA, PRICE PFISTER, AMERICAN STANDARD bath and tub and shower faucets
- 4" long x 2" tall

PART#	DESCRIPTION
1304	Lever handle

DELTA

DELTA LEVER FAUCET LONG KITCHEN LEVER



- Single die cast chrome metal handle
- Fits DELTA kitchen faucets
- Fits #70 and #212 ball faucets

PART#	BULK PART#	DESCRIPTION
1305	1305Q	Long kitchen lever

DELTA SHOWER HANDLE, LEVER



- Single die cast chrome metal handle
- Complete with three cartridge adaptors, for 70 ball, 212 ball, & pressure balance cartridge rp19804
- For Series 600 valves and Monitor 14 series

PART#	BULK PART#	DESCRIPTION
1318	1318Q	Shower handle lever

DELTA SHOWER HANDLE, ACRYLIC



- Acrylic handle for DELTA shower valve
- Complete with three cartridge adaptors, for 70 ball, 212 ball, & pressure balance cartridge rp19804
- For Series 600 valves and Monitor 14 series

PART#	BULK PART#	DESCRIPTION
1319	1319Q	Acrylic shower handle

FAUCET REPAIR

DELTA

DELTA BLADE HANDLES



- Hot / cold pair
- 4" blade handle
- OEM ref#RP12941
- Chrome plated

DELTA SINGLE LEVER HANDLE



- Small for Lavatory 3-1/4" handle OEM ref#RP90
- Large for Kitchen 5-1/4" handle OEM ref#RP2393
- Chrome plated

PART#	BULK PART#	DESCRIPTION
13022	13022Q	Blade handle

PART#	BULK PART#	DESCRIPTION
13023	13023Q	Small
13024	13024Q	Large

DELTA REPAIR KITS



- Repair kit for single lever faucet
- DELTA & PEERLESS OEM ref#RP3614
- Replacement wrench OEM ref#RP1974

DELTA H79 MONITOR LEVER HANDLE



- For 1400 Series, single
- Chrome Plate Brass
- 4-1/4" overall

PART#	BULK PART#	DESCRIPTION
12829	12829Q	Kit
12830	12830Q	Wrench only

PART#	DESCRIPTION
13010	H79 handle

DELTA SPRING AND SEATS



- Sold separately, or as a kit of both
- Part#13012 OEM ref#RP1806
- Part#13013 OEM ref#RP1505
- Part#13014 OEM ref#RP3427
- Part#13015 OEM ref# RP1181

DELTA INDEX BUTTONS



- DELTA index buttons
- Part#13017 OEM ref#RP2412
- Part#13019 OEM ref#RP1711C

PART#	BULK PART#	DESCRIPTION
13012	13012Q	Seat new style
13013	13013Q	Seat old style
13014	13014Q	Spring new conical
13015	13015Q	Spring old straight
13016		Repair kit old style
13018		Repair kit new style

PART#	BULK PART#	DESCRIPTION
13017	13017Q	For DELTA / PEERLESS H/C
13019	13019Q	For CRYSTAL handle prior 1991
2019	2019Q	For DELTA acrylic handles

OEM (Original Equipment Manufacturer) numbers, registered / non registered trademarks, faucet name, and manufacturer listed above are supplied and listed for your reference only. All LynCar items are precision made and tested to the highest standards, by qualified factories inspected and approved by LynCar.

DELTA

DELTA / DELEX CARTRIDGE



- For two handle faucets
- Stainless steel bottom
- Plastic body
- OEM ref#RP1740

PART#	BULK PART#	DESCRIPTION
11210	11210Q	DELTA / DELEX cartridge

DELTA BALLS

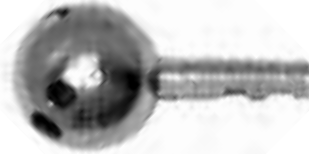

- Available in plastic or stainless steel
- **Part#927** & **part#927Q** OEM ref#RP70
- **Part#927A** & **part#927AQ** OEM ref#RP212

PART#	BULK PART#	DESCRIPTION
926	926Q	Plastic
927	927Q	S/S for DELTA
927A	927AQ	S/S for PEERLESS

DELTA SCALDGUARD CARTRIDGE



- For kitchen lavatory and tub & shower
- OEM ref#RP1991

PART#	BULK PART#	DESCRIPTION
11212	11212Q	DELTA scaldguard cartridge

PLASTIC REPLACEMENT CARTRIDGE



- For PEERLESS Plastic Body

PART#	BULK PART#	DESCRIPTION
11215	11215Q	Replacement cartridge

DELTA PRESSURE BALANCE CARTRIDGE



- For 1300 /1400 Series
- OEM ref#RP19804

PART#	BULK PART#	DESCRIPTION
11222	11222Q	Pressure balance cartridge

DELTA PUSH BUTTON DIVERTER



- For lavatory kitchen tub and shower
- 3-3/4" long
- OEM ref#RP5649

PART#	BULK PART#	DESCRIPTION
11220	11220Q	Push button diverter

OEM (Original Equipment Manufacturer) numbers, registered / non registered trademarks, faucet name, and manufacturer listed above are supplied and listed for your reference only. All LynCar items are precision made and tested to the highest standards, by qualified factories inspected and approved by LynCar.

DELTA

**DELTA / CAMBRIDGE BRASS
TEMPUS METERING REPLACEMENT**



- DELTA / CAMBRIDGE brass tempus metering
- Replacement cartridge
- For single and 4" centreset faucets
- OEM ref#060160A

DELTA SLOW CLOSE CARTRIDGE



- For lavatory, kitchen and tub / shower
- Commercial cartridge valve stem

PART#	BULK PART#	DESCRIPTION
11350	11350Q	DELTA / CAMBRIDGE brass tempus

PART#	BULK PART#	DESCRIPTION
11225	11225Q	Slow close cartridge

DELTA TUB SHOWER CARTRIDGE



- For DELEX three handle
- OEM ref#RP17730

PART#	BULK PART#	DESCRIPTION
11223	11223Q	Tub shower cartridge

DELTA BRASS DIVERTER



- DELTA diverter for single handle kitchen faucet with diverter
- OEM ref#RP230

PART#	BULK PART#	DESCRIPTION
13021	13021Q	Brass diverter

OEM (Original Equipment Manufacturer) numbers, registered / non registered trademarks, faucet name, and manufacturer listed above are supplied and listed for your reference only. All LynCar items are precision made and tested to the highest standards, by qualified factories inspected and approved by LynCar.

EMCO

EMCO ELAN CARTRIDGE HOT / COLD



- OEM ref#1157

PART#	BULK PART#	DESCRIPTION
919	919Q	Cartridge

EMCO SEATS



- Standard OEM ref#51-137169
- Extended OEM ref#51-137719

PART#	BULK PART#	DESCRIPTION
12820	12820Q	9/16 x 27 TPI
923	923Q	9/16 x 27 TPI x 1-1/8" T/S

EMCO DIVERTER CARTRIDGE NEW STYLE FACEMOUNT



- Chrome plated brass knob
- Height 3-3/4"
- OEM ref#51-193782

PART#	BULK PART#	DESCRIPTION
920	920Q	Diverter cartridge

EMCO DIVERTER FOR CONCEALED TUB & SHOWER



- Chrome brass knob
- Height 6-1/2"
- OEM ref#51-193209

PART#	BULK PART#	DESCRIPTION
9231	9231Q	Diverter
9231H	9231HQ	Knob only

EMCO DIVERTER DORIC STYLE FOR 3 VALVE TUB & SHOWER



- Height 4"
- OEM ref#51-138966

PART#	BULK PART#	DESCRIPTION
921	921Q	Diverter

EMCO DIVERTER FACEMOUNT TUB AND SHOWER



- Height 2 1/2" (3 1/4" with Handle)
- OEM ref#51-193210

PART#	BULK PART#	DESCRIPTION
12821	12821Q	Diverter

OEM (Original Equipment Manufacturer) numbers, registered / non registered trademarks, faucet name, and manufacturer listed above are supplied and listed for your reference only. All LynCar items are precision made and tested to the highest standards, by qualified factories inspected and approved by LynCar.

FAUCET REPAIR

EMCO

EMCO CORONA HANDLES CHROME PLATED PLASTIC



- Hot / cold pair
- Chrome plated plastic
- Large height 1-3/4" OEM ref#1299, Small height 1-1/2" OEM ref#2198

PART#	BULK PART#	DESCRIPTION
2003	2003Q	Large
2004	2004Q	Small

EMCO CORONA HANDLES CHROME PLATED METAL



- Hot / cold pair
- Large height 1-3/4" OEM ref#2199, Small height 1-3/2" OEM ref#2198M

PART#	BULK PART#	DESCRIPTION
2006	2006Q	Large
2005	2005Q	Small

EMCO SAPPHIRE CHROME PLATED ACRYLIC HANDLES



- Hot / cold pair
- Chrome plated acrylic handles
- Large OEM ref#2399, Small OEM ref#2398

PART#	BULK PART#	DESCRIPTION
2024	2024Q	Small
2025	2025Q	Large

EMCO LAUNDRY HANDLES PLASTIC HANDLE WITH SCREW



- Red (hot) OEM ref#51-195641
- Blue (cold) OEM ref#51-195640

PART#	BULK PART#	DESCRIPTION
2013	2013Q	Red
2014	2014Q	Blue

EMCO 1057 CARTRIDGE HOT / COLD



- OEM ref#1057

PART#	BULK PART#	DESCRIPTION
900	900Q	Cartridge

EMCO LAUNDRY CARTRIDGE HOT / COLD



- Hot / cold
- OEM ref#51-195223

PART#	BULK PART#	DESCRIPTION
899	899Q	Cartridge

EMCO REPLACEMENT HANDLE INSERTS



- Sold in pairs
- EMCO replacement handle inserts
- For EMCO CORONA handles
- Metal and plastic handles
- New style OEM ref#51-194943
- Old style OEM ref#51-191032

PART#	BULK PART#	DESCRIPTION
891	891Q	New style
892	892Q	Old style

EMCO REPLACEMENT INDEX BUTTONS



- EMCO replacement index buttons
- For EMCO CORONA handles
- Metal and plastic handles
- OEM ref#51-197775/6

SMALL PART#	LARGE PART#	DESCRIPTION
2026	2027	H/C plastic
2028	2029	H/C metal

OEM (Original Equipment Manufacturer) numbers, registered / non registered trademarks, faucet name, and manufacturer listed above are supplied and listed for your reference only. All LynCar items are precision made and tested to the highest standards, by qualified factories inspected and approved by LynCar.

FIT ALL

FIT ALL HANDLE ACRYLIC STYLE



- Hot / cold pair
- Small, large, diverter
- Supplied with adaptor and Allen Key

PART#	BULK PART#	DESCRIPTION
12931	12931Q	Tub & shower - large
12932	12932Q	Diverter tub & shower - large
12933	12933Q	Lav & kitchen - small

FIT ALL HANDLE METAL DOME CANOPY STYLE



- Hot / cold pair
- Small, medium and large
- Supplied with adaptor and Allen Key

PART#	BULK PART#	DESCRIPTION
12945	12945Q	Lavatory small - height 1-1/4"
12950	12950Q	Kitchen - height 1-1/2"
12955	12955Q	Tub & shower - height 1-3/4"

FIT ALL HANDLE LEVER METAL STYLE



- Hot / cold pair
- Small and large
- Supplied with adaptor and Allen Key

PART#	BULK PART#	DESCRIPTION
12915	12915Q	Lavatory small - height 1-3/8"
12920	12920Q	Kitchen - height 1-1/2"

FIT ALL HANDLE METAL CROSS HANDLE STYLE



- Hot / cold pair
- Supplied with adaptor and Allen Key

PART#	BULK PART#	DESCRIPTION
12940	12940Q	Cross handles

FIT ALL DECORATIVE CHROME HANDLE



- Decorative handle assembly, fits most faucets
- Adaptors, screws, included
- Chrome plated brass handle, die cast housing
- Sold per pair

PART#	DESCRIPTION
12960	Chrome

FIT ALL DECORATIVE PORCELAIN HANDLE



- Decorative handle assembly, fits most faucets
- Adaptors, screws, included
- Chrome plated brass and porcelain handle, die cast housing
- Sold per pair

PART#	DESCRIPTION
12962	Porcelain

OEM (Original Equipment Manufacturer) numbers, registered / non registered trademarks, faucet name, and manufacturer listed above are supplied and listed for your reference only. All LynCar items are precision made and tested to the highest standards, by qualified factories inspected and approved by LynCar.

GALTMASTER

GALTMASTER DIVERTER CARTRIDGE



- For shower valves 1953 to 1963
- 4-3/4" overall Length
- OEM ref#70281

GALTMASTER STEM REPLACEMENT



- For shower valves 1933 to 1969
- 4" overall length
- OEM ref#70283

PART#	BULK PART#	DESCRIPTION	PART#	BULK PART#	DESCRIPTION
890	890Q	Diverter cartridge	895	895Q	Stem replacement

GALTMASTER DIVERTER STEM T/S



- For shower valves 1954/63
- 5-3/8" overall length
- OEM ref#70282

GALTMASTER STEM REPLACEMENT T/S



- For shower valves 1963 to 1965
- 5-1/4" overall length
- OEM ref#70284

PART#	BULK PART#	DESCRIPTION	PART#	BULK PART#	DESCRIPTION
879	879Q	GALTMASTER diverter stem	878	878Q	Stem replacement

GALT CARTRIDGE L.H COLD CARTRIDGE (1963—1970)



- 1-3/4" length
- OEM ref#70012

GALT CARTRIDGE R.H HOT CARTRIDGE (1963—1970)



- 1-3/4" length
- OEM ref#70080

PART#	BULK PART#	DESCRIPTION	PART#	BULK PART#	DESCRIPTION
894	894Q	L.H cold cartridge	893	893Q	R.H hot cartridge

OEM (Original Equipment Manufacturer) numbers, registered / non registered trademarks, faucet name, and manufacturer listed above are supplied and listed for your reference only. All LynCar items are precision made and tested to the highest standards, by qualified factories inspected and approved by LynCar.

GERBER

GERBER WATERLESS CARTRIDGE HOT



- 1-3/4" overall length
- OEM ref#98-710

GERBER WATERLESS CARTRIDGE COLD



- 1-3/4" overall length
- OEM ref#98-711

PART#	BULK PART#	DESCRIPTION	PART#	BULK PART#	DESCRIPTION
954	954Q	Waterless cartridge hot	955	955Q	Waterless cartridge cold

GERBER HANDLE DIE CAST METAL, CHROME



- Hot / cold pair
- Short broach
- 2-1/2" overall length
- OEM ref#98-443H/C

GERBER HANDLE DIE CAST METAL, CHROME



- Hot / cold pair
- Long broach
- 2-1/2" overall length
- OEM ref#98-427/28

PART#	BULK PART#	DESCRIPTION	PART#	BULK PART#	DESCRIPTION
9540	9540Q	Short broach	9541	9541Q	Long broach

FAUCET REPAIR

OEM (Original Equipment Manufacturer) numbers, registered / non registered trademarks, faucet name, and manufacturer listed above are supplied and listed for your reference only. All LynCar items are precision made and tested to the highest standards, by qualified factories inspected and approved by LynCar.

JAMECO

JAMECO LEVER HANDLES



- Hot / cold pair
- Chrome metal
- OEM ref#1010

JAMECO CROWN HANDLES



- Hot / cold pair
- Chrome metal
- OEM ref#1092

PART#	BULK PART#	DESCRIPTION
12827	12827Q	Chrome metal

PART#	BULK PART#	DESCRIPTION
12826	12826Q	Chrome metal

JAMECO FAUCET CARTRIDGE FOR WASHER TYPE FAUCETS



- 1-3/4" overall length
- OEM ref#1100 Hot
- OEM ref#1101 Cold

PART#	BULK PART#	DESCRIPTION
905	905Q	Hot
906	906Q	Cold

JAMECO FAUCET SEAT



- 1/2" x 20 TPI
- OEM ref#1102
- Sold per pair

PART#	BULK PART#	DESCRIPTION
12822	12822Q	JAMECO faucet seat

OEM (Original Equipment Manufacturer) numbers, registered / non registered trademarks, faucet name, and manufacturer listed above are supplied and listed for your reference only. All LynCar items are precision made and tested to the highest standards, by qualified factories inspected and approved by LynCar.

MIXET

**MIXET ROUND HANDLE
CLEAR ACRYLIC T/S HANDLE**



- MIXET round handle
- Die cast metal, chrome
- T/S handle
- 2-1/4" diameter
- OEM ref#MRH MET

**MIXET LEVER HANDLE
CLEAR ACRYLIC T/S HANDLE**



- Clear acrylic T/S handle
- 2-3/8" diameter
- OEM ref#MLH CLR

PART#	BULK PART#	DESCRIPTION
13025	13025Q	Acrylic
13030	13030Q	Metal

PART#	BULK PART#	DESCRIPTION
13026	13026Q	Acrylic

**MIXET LEVER INNER HANDLE
VOLUME CONTROL LEVER**

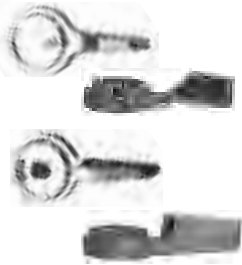

- part#13029**
- Chrome plated die cast metal
 - 2-1/4" lever, 4-1/2" overall

- part# 13031**
- Volume control lever
 - Chrome plastic
 - 2-3/4" lever, 5" overall
 - OEM ref#MLH CP

MIXET LEVER METAL



- MIXET single lever
- Handicap volume control
- OEM ref# MLH-HH



PART#	BULK PART#	DESCRIPTION
13029	13029Q	2-1/4" lever, 4-1/2" overall
13031	13031Q	2-3/4" lever, 5" overall

PART#	DESCRIPTION
13032	MIXET lever shower handle

**MIXET TUB & SHOWER CARTRIDGE
WITH CHROME RETAINER NUT**



- With chrome retainer nut
- Overall 4-3/8"
- OEM ref#MS5AT-C

MIXET REPLACEMENT SEAT



- Chrome brass
- 1/2" diameter 11/32 long
- Sold per pair

PART#	BULK PART#	DESCRIPTION
13027	13027Q	Tub & shower cartridge

PART#	BULK PART#	DESCRIPTION
13028	13028Q	MIXET replacement seat

OEM (Original Equipment Manufacturer) numbers, registered / non registered trademarks, faucet name, and manufacturer listed above are supplied and listed for your reference only. All LynCar items are precision made and tested to the highest standards, by qualified factories inspected and approved by LynCar.

MOEN

MOEN CHATEAU HANDLES SHORT BROACH, FOR FAUCET



- Short broach, for faucet OEM ref#94791
- Long broach for shower OEM ref#96797

PART#	BULK PART#	DESCRIPTION
2015	2015Q	Short broach
2016	2016Q	Long broach

MOEN LEGEND HANDLES SHORT BROACH, FOR FAUCET



- Short broach, for faucet OEM ref#13092
- Long broach for shower OEM ref#13094

PART#	BULK PART#	DESCRIPTION
2017	2017Q	Short broach
2018	2018Q	Long broach

MOEN CHATEAU SINGLE LEVER CAP AND HANDLE (SOLD SEPARATELY)



- Cap OEM ref#96790
- Handle OEM ref#10927

PART#	BULK PART#	DESCRIPTION
11275	11275Q	Cap only
11275H	11275HQ	Handle only

MOEN POST TEMP HOT/COLD LEVER SHOWER HANDLE



- Chrome plated die cast
- 4-1/4" overall size
- OEM ref#14732

PART#	BULK PART#	DESCRIPTION
11278	11278Q	Chrome plated die cast

OEM (Original Equipment Manufacturer) numbers, registered / non registered trademarks, faucet name, and manufacturer listed above are supplied and listed for your reference only. All LynCar items are precision made and tested to the highest standards, by qualified factories inspected and approved by LynCar.

MOEN

MOEN TUB AND SHOWER LEVER FOR MOEN COMMERCIAL



- For MOEN COMMERCIAL
- 4" CP plastic handle
- OEM ref#13291

PART#	BULK PART#	DESCRIPTION
11276	11276Q	4" CP plastic handle

MOEN ACRYLIC TUB AND SHOWER HANDLES



- Hot / cold pair
- Overall 2-1/2" height
- OEM ref#14359

PART#	BULK PART#	DESCRIPTION
11279	11279Q	Overall 2-1/2" height

MOEN MAGNUM SHOWER CARTRIDGE



- 3-7/8" overall length
- OEM ref#1225B

PART#	BULK PART#	DESCRIPTION
944	944Q	OEM ref# 1225B

MOEN FAUCET CARTRIDGE



- Can be used on hot or cold
- For two handle faucets
- OEM ref#1224

PART#	BULL PART#	DESCRIPTION
11270	11270Q	Faucet cartridge

OEM (Original Equipment Manufacturer) numbers, registered / non registered trademarks, faucet name, and manufacturer listed above are supplied and listed for your reference only. All LynCar items are precision made and tested to the highest standards, by qualified factories inspected and approved by LynCar.

MOEN

MOEN BRASS FAUCET SHOWER CARTRIDGE



- OEM ref#1200B
- 3-7/8" overall length

PART#	BULK PART#	DESCRIPTION
11271	11271Q	MOEN brass faucet shower cartridge

MOEN POSI-TEMP SHOWER CARTRIDGE



- Cycling valve
- OEM ref#1222B
- 4-1/8" overall length

PART#	BULK PART#	DESCRIPTION
11272	11272Q	Posi-temp shower cartridge

MOEN HOT / COLD METERING CARTRIDGE



- Metering cartridge
- 3-3/8" overall length
- OEM ref#13652

PART#	DESCRIPTION
11273	1/2" IPS shank

MOEN CLIPS



- Retaining clips for single handle MOEN faucets
- 25 per bag
- 3 types available

PART#	DESCRIPTION
11255	Model# 883
11260	Model# 1171
11265	Model# 1883

OEM (Original Equipment Manufacturer) numbers, registered / non registered trademarks, faucet name, and manufacturer listed above are supplied and listed for your reference only. All LynCar items are precision made and tested to the highest standards, by qualified factories inspected and approved by LynCar.

MUELLER

MUELLER CARTRIDGE FOR CENTRESET



- Can be used on hot or cold
- For CENTRESET
- 2" overall length
- OEM ref#91470

MUELLER DIVERTER FOR BEAUTYCRAFT T/S



- For BEAUTYCRAFT T/S MARK III & MARK IV
- 4-1/4" overall length
- OEM ref#91286

PART#	BULK PART#	DESCRIPTION	PART#	BULK PART#	DESCRIPTION
903	903Q	For CENTRESET	943	943Q	For BEAUTYCRAFT T/S

MUELLER DIVERTER FOR BEAUTYCRAFT T/S



- For BEAUTYCRAFT T/S, MARK III & MARK IV
- 5-1/4" overall length
- OEM ref#91406

MUELLER FAUCET SEAT



- 17/32 x 24 TPI

PART#	BULK PART#	DESCRIPTION	PART#	BULK PART#	DESCRIPTION
9030	9030Q	For BEAUTYCRAFT T/S	9031	9031Q	MUELLER faucet seat

FAUCET REPAIR

OEM (Original Equipment Manufacturer) numbers, registered / non registered trademarks, faucet name, and manufacturer listed above are supplied and listed for your reference only. All LynCar items are precision made and tested to the highest standards, by qualified factories inspected and approved by LynCar.

POWERS

POWERS CRANE REBUILD KITS



- For Shower Valves
- **Part#11410** is the picture shown
- **Part#11410** OEM ref#410-182
- **Part#11800** OEM ref#800-030
- **Part#11900** OEM ref#900-030

POWERS CRANE STEM KIT



- For 400 / 0410 models 1 to 3
- Stem, washers, O rings
- OEM ref#410-378

PART#	DESCRIPTION
11410	For 400/410 series
11800	For 800 series
11900	For 900 series

PART#	DESCRIPTION
11414	POWERS CRANE stem kit

POWERS CRANE SHOWER VALVE HANDLE



- Smoked crystal, with handle cap included.
- OEM ref#401-090, 401086/80/90

POWERS CRANE SHOWER VALVE CARTRIDGE KITS



- Screw in cartridge spool
- Spring and washers
- For 800 and 900 series models
- OEM ref#800-163 , 900-232

PART#	DESCRIPTION
11412	POWERS CRANE Shower Valve Handle

PART#	DESCRIPTION
11802	For 800
11902	For 900

POWERS CRANE SHOWER VALVE HANDLE



- Chrome die cast metal lever
- With two plastic inserts
- For 800 and 900 series valves
- OEM ref#800-036

POWERS CRANE SHOWER VALVE HANDLE



- Crystal round handle
- With cap, screw, and adaptors
- For 800 series valves
- OEM ref#800-200

PART#	DESCRIPTION
11198	POWERS CRANE Shower Valve Handle

PART#	DESCRIPTION
111804	POWERS CRANE Shower Valve Handle

OEM (Original Equipment Manufacturer) numbers, registered / non registered trademarks, faucet name, and manufacturer listed above are supplied and listed for your reference only. All LynCar items are precision made and tested to the highest standards, by qualified factories inspected and approved by LynCar.

PRICE PFISTER

PRICE PFISTER CANOPY HANDLES



- Hot / cold pair
- Chrome die cast handles
- Fits VERVE series
- Large 2-1/2" height
- Small 1-5/8" height
- OEM ref#940-320A , 941-321A

PRICE PFISTER ACRYLIC HANDLES



- Hot / cold pair
- Fits WINDSOR series
- Large 2-7/8" height
- Small 1-7/8" height
- OEM ref#940-740A , 940-730A

PART#	SIZE	DESCRIPTION
21510	Large	Hot / cold pair
21520	Small	Hot / cold pair
21510D	Large	Diverter

PART#	SIZE	DESCRIPTION
21740	Large	Hot / cold pair
21730	Small	Hot / cold pair
21740D	Large	Diverter

PRICE PFISTER METAL HANDLES CHROME DIE CAST HANDLES



- Hot / cold pair
- Fits CONTEMPERA series
- Large 2-1/4" height
- Small 1-1/2" height
- OEM ref#940-050A , 940-060A

PART#	SIZE	DESCRIPTION
21020	Large	Hot / cold pair
21050	Small	Hot / cold pair
21020D	Large	Diverter

PRICE PFISTER METAL HANDLES CHROME DIE CAST HANDLES



- Hot / cold pair
- Chrome die cast handles
- Fits CROWN JEWEL series
- 1" height
- OEM ref#940-220 , 940-210

PART#	DESCRIPTION
21210	Hot / cold pair

FAUCET REPAIR

OEM (Original Equipment Manufacturer) numbers, registered / non registered trademarks, faucet name, and manufacturer listed above are supplied and listed for your reference only. All LynCar items are precision made and tested to the highest standards, by qualified factories inspected and approved by LynCar.

PRICE PFISTER

PRICE PFISTER CARTRIDGE
COMPRESSION STEM



- For lav & kitchen
- Fits JEWEL, IMPERIAL and others
- Height 1-9/16
- OEM ref#910-072 (Hot) OEM ref#910 082 (Cold)

PRICE PFISTER CARTRIDGE
ALL BRASS STEM



- For lav & kitchen
- Fits COMTEMPRA, MARQUIS, VERVE
- Height 1-5/8
- OEM ref#910-392

PART# DESCRIPTION

21082H	Hot cartridge
21082C	Cold cartridge

PART# DESCRIPTION

21392	Cartridge can be used on hot or cold
--------------	--------------------------------------

PRICE PFISTER CARTRIDGE



- For lav & kitchen
- Fits CROWN JEWEL
- Height 1-7/8
- OEM ref#910-282 Hot 910 292 Cold

PART# DESCRIPTION

21282H	Hot cartridge
21282C	Cold cartridge

PRICE PFISTER CARTRIDGE



- For lav & kitchen
- Brass washerless cartridge
- Height 2"
- OEM ref#910-651

PART# DESCRIPTION

21681	Cartridge can be used on hot or cold
--------------	--------------------------------------

PRICE PFISTER SEATS



- Sold per pair
- For lav & kitchen
- 2 & 3 valves

PART# DESCRIPTION

21500	21/32 x 18 TPI x 3/8
21502	1/2 x 20 TPI x 3/8

PRICE PFISTER SHOWER VALVE
FLANGES



- Tapered and hex style
- Chrome plated

PART# SIZE DESCRIPTION

21110	2-3/16"	Tapered
21280	1-3/4"	Hexagon

OEM (Original Equipment Manufacturer) numbers, registered / non registered trademarks, faucet name, and manufacturer listed above are supplied and listed for your reference only. All LynCar items are precision made and tested to the highest standards, by qualified factories inspected and approved by LynCar.

PRICE PFISTER

PRICE PFISTER DIVERter CARTRIDGE FOR IMPERIAL



- Size 4-1/4"
- OEM ref#910-012/ 013/ 014/ 034

PART#	DESCRIPTION
21034	For IMPERIAL

PRICE PFISTER DIVERter CARTRIDGE FOR 2 & 3 VALVE, BEAUX



- Size 4-1/4"
- OEM ref#910-052

PART#	DESCRIPTION
21052	For 2 & 3 valve, BEAUX ART

PRICE PFISTER DIVERter CARTRIDGE FOR BEAUX ART



- For BEAUX ART RH STEM & BONNET
- Overall length 5-1/32"
- OEM ref#910043

PART#	DESCRIPTION
21043	For BEAUX ART

PRICE PFISTER SHOWER CARTRIDGE FOR COMTEMPERA, MARQUIS, VERVE, WINDSOR



- Overall length 5-9/16"

PART#	DESCRIPTION
21374	VERVE shower stem

PRICE PFISTER DIVERter CARTRIDGE



- For COMTEMPRA, MARQUIS, VERVE
- Size 5-11/16"
- OEM ref#910-385

PART#	DESCRIPTION
21385	PRICE PFISTER diverter cartridge

FAUCET REPAIR

OEM (Original Equipment Manufacturer) numbers, registered / non registered trademarks, faucet name, and manufacturer listed above are supplied and listed for your reference only. All LynCar items are precision made and tested to the highest standards, by qualified factories inspected and approved by LynCar.

STERLING

STERLING TEMPO ACRYLIC HANDLES



- Hot / cold pair
- 2-1/8" height
- OEM ref#A8369

STERLING STARFLO HANDLES



- Hot / cold pair
- Chrome plated metal lever
- 1-1/2" height
- OEM ref#A1926

PART#	DESCRIPTION
929	STERLING TEMPO acrylic handles
929Q	STERLING TEMPO acrylic handles - bulk

PART#	DESCRIPTION
930	STERLING STARFLO handles
930Q	STERLING STARFLO handles - bulk

STERLING METAL LOOP HANDLE USE FOR LAVATORY AND T/S



- 1-7/16" height
- OEM ref#A5043

STERLING REPAIR KIT FOR KITCHEN FAUCETS



- OEM ref#A5020

PART#	DESCRIPTION
11304	Handle
11304Q	Handle - bulk

PART#	DESCRIPTION
11302	Repair kit
11302Q	Repair kit - bulk

STERLING REPAIR KIT FOR TUB & SHOWERS



- OEM ref#05010

STERLING REPLACEMENT SEATS



- Sold per pair
- 1/2" x 24 TPI
- OEM ref#99S0369

PART#	DESCRIPTION
11303	Repair kit
11303Q	Repair kit - bulk

PART#	DESCRIPTION
9480	Seats
9480Q	Seats - bulk

OEM (Original Equipment Manufacturer) numbers, registered / non registered trademarks, faucet name, and manufacturer listed above are supplied and listed for your reference only. All LynCar items are precision made and tested to the highest standards, by qualified factories inspected and approved by LynCar.

STERLING

STERLING CARTRIDGE FOR KITCHEN & LAVATORY BRASS CARTRIDGE



- OEM ref#A8153/54

PART#	BULK PART#	DESCRIPTION
924	924Q	Hot
925	925Q	Cold

STERLING CARTRIDGE FOR KITCHEN



- Plastic 2-1/2" height
 - With or without spray
 - OEM ref#A5013 / 5023

PART#	BULK PART#	DESCRIPTION
11300	11300Q	Less spray
11305	11305Q	With spray

STERLING TUB & SHOWER CARTRIDGE 4-1/2" HEIGHT



- OEM ref#A8105

PART#	BULK PART#	DESCRIPTION
948	948Q	STERLING T/S cartridge

STERLING TUB & SHOWER CARTRIDGE OLD STYLE, 4-1/2" HEIGHT



- OEM ref#A8106

PART#	BULK PART#	DESCRIPTION
949	949Q	STERLING T/S cartridge

STERLING TUB & SHOWER CARTRIDGES



- OEM ref#05300 brass stem

PART#	BULK PART#	DESCRIPTION
11307	11307Q	Brass

OEM (Original Equipment Manufacturer) numbers, registered / non registered trademarks, faucet name, and manufacturer listed above are supplied and listed for your reference only. All LynCar items are precision made and tested to the highest standards, by qualified factories inspected and approved by LynCar.

FAUCET REPAIR

SYMMONS

SYMMONS TRI CANOPY HANDLE FOR TEMPTROL



Handle & button

- Die cast metal
- OEM ref#T31

Index button for TRI CANOPY handle

- OEM ref#T33

PART#	BULK PART#	DESCRIPTION
11326	11326Q	Handle & button
11352	11352Q	Button only

SYMMONS TRI CANOPY HANDLE FOR TEMPTROL II



- Die cast metal
- OEM ref#T65

PART#	BULK PART#	DESCRIPTION
11342	11342Q	for TEMPTROL II

SYMMONS HANDLE



- Crystal Handle for T&S for TEMPTROL

PART#	BULK PART#	DESCRIPTION
11328	11328Q	Handle

SYMMONS DIVERTER HANDLE FOR TEMPTROL



- Die cast metal, comes with clip
- OEM ref#T30

PART#	BULK PART#	DESCRIPTION
11327	11327Q	Handle

SYMMONS SAFETY MIX LEVER HANDLES DIE CAST METAL



- Tub and shower 1-1/2" height
- Kitchen lavatory 7/8" height
- OEM ref#R14

PART#	BULK PART#	DESCRIPTION
11341	11341Q	Small
11337	11337Q	Large

OEM (Original Equipment Manufacturer) numbers, registered / non registered trademarks, faucet name, and manufacturer listed above are supplied and listed for your reference only. All LynCar items are precision made and tested to the highest standards, by qualified factories inspected and approved by LynCar.

SYMMONS

SYMMONS THREADED DOME ESCUTCHEON



- For TEMPTRON
- OEM ref#T19 / T20

PART#	BULK PART#	DESCRIPTION
11353	11353Q	Escutcheon

SYMMONS TEMPTRON HOT & COLD REMOVAL TOOLS



PART#	DESCRIPTION
11330	Removal tools

SYMMONS CARTRIDGE SPINDLE ASSEMBLY FOR TEMPTRON



- Length 4-7/16"
- OEM ref#TA10

PART#	BULK PART#	DESCRIPTION
11333	11333Q	Spindle assembly

SYMMONS CARTRIDGE SPINDLE ASSEMBLY FOR SAFETY MIX



- Length 5-1/16"
- OEM ref#C5

PART#	BULK PART#	DESCRIPTION
11335	11335Q	Spindle assembly

SYMMONS DIVERTER ASSEMBLY FOR TEMPTRON



- Length 2-3/8"
- OEM ref#TA-25A

PART#	BULK PART#	DESCRIPTION
11354	11354Q	Diverter assembly

SYMMONS CARTRIDGE SPINDLE ASSEMBLY FOR SAFETY MIX



- Washer kit for SAFETYMIX OEM ref#Kit B
- Washer kit for TEMPTRON OEM ref#TA9
- Seat repair kit TEMPTRON OEM ref#T4

PART#	DESCRIPTION
11334	Washer kit for SAFETYMIX
11344	Washer kit for TEMPTRON
11343	Seat repair kit TEMPTRON

OEM (Original Equipment Manufacturer) numbers, registered / non registered trademarks, faucet name, and manufacturer listed above are supplied and listed for your reference only. All LynCar items are precision made and tested to the highest standards, by qualified factories inspected and approved by LynCar.

T&S BRASS

T&S FAUCET STEM
HOT OR COLD



- Stems for ETERNA cartridge from T&S

T&S CARTRIDGE ASSEMBLY FOR
ETERNA, INCLUDES BONNET



- OEM ref#002714-40 Hot
- OEM ref#002713-40 Cold

PART#	BULK PART#	DESCRIPTION
33074	33074Q	Hot
33073	33073Q	Cold

PART#	DESCRIPTION
33076	Hot
33075	Cold

T&S CARTRIDGE INSERT FOR
ETERNA



- OEM ref#1000788-20 (Hot)
- OEM ref#1000789-20 (Cold)

T&S CARTRIDGE ASSEMBLY FOR
HOT SPRING, INCLUDES BONNET



- OEM ref#002712-40 (Hot)
- OEM ref#002711-40 (Cold)

PART#	BULK PART#	DESCRIPTION
33078	33078Q	Hot
33077	33077Q	Cold

PART#	DESCRIPTION
33080	Hot
33079	Cold

T&S CARTRIDGE PRE RINSE SPRAY
FITS SPRAY ASSEMBLY & PEDAL
VALVES



- OEM ref#002856-40

T&S METERING CARTRIDGE &
HANDLE



- OEM ref#0238AB

PART#	DESCRIPTION
33019	T&S cartridge pre rinse spray

PART#	DESCRIPTION
33081	T&S metering cartridge & handle

OEM (Original Equipment Manufacturer) numbers, registered / non registered trademarks, faucet name, and manufacturer listed above are supplied and listed for your reference only. All LynCar items are precision made and tested to the highest standards, by qualified factories inspected and approved by LynCar.

VALLEY

VALLEY SINGLE LEVER HANDLE



- Crystal OEM ref#V6904
- Acrylic handle or die cast metal

PART#	DESCRIPTION
7063	Crystal
11304	Metal

VALLEY CHROME PLASTIC DOME HANDLES HOT/COLD



- Hot / cold pair
- OEM ref#V7804

PART#	BULK PART#	DESCRIPTION
7069	7069Q	Chrome plastic

VALLEY CARTRIDGE FOR LAV, KITCHEN



- Single lever faucets
- OEM ref#V6680

PART#	BULK PART#	DESCRIPTION
7050	7050Q	Cartridge

VALLEY METAL SINGLE LEVER HANDLES



- Old Style OEM ref# V1165
- New Style OEM ref#VP1989

PART#	STYLE
7066	Old
7067	New

VALLEY CARTRIDGE FOR TWO HANDLE FAUCETS



- Cartridge can be used for hot or cold
- OEM ref#V6804

PART#	BULK PART#	DESCRIPTION
7052	7052Q	Cartridge

VALLEY CARTRIDGE LEVER FAUCETS WITH/WITHOUT DIVERTER



PART#	BULK PART#	DIVERTER
7056	7056Q	No
7057	7057Q	Yes

OEM (Original Equipment Manufacturer) numbers, registered / non registered trademarks, faucet name, and manufacturer listed above are supplied and listed for your reference only. All LynCar items are precision made and tested to the highest standards, by qualified factories inspected and approved by LynCar.

FAUCET REPAIR

WALLACEBURG

**WALLACEBURG CARTRIDGE
FOR OLD STYLE DECK FAUCETS**



- Hot or cold
- 2" height
- OEM ref#W3242

PART#	BULK PART#	DESCRIPTION
939	939Q	Hot
940	940Q	Cold

**WALLACEBURG CARTRIDGE FOR CENTRESETS
AND TUB & SHOWER**



- Hot or cold
- OEM ref#W3242

PART#	BULK PART#	DESCRIPTION
941	941Q	Hot
942	942Q	Cold

**WALLACEBURG DIVERTER FOR TUB & SHOWER
JUBILEE 1950 TO 1968**



- Height 4-3/4"
- OEM ref#T3773

PART#	BULK PART#	DESCRIPTION
9390	9390Q	Diverter

**WALLACEBURG DIVERTER FOR TUB & SHOWER JUBILEE
1950 TO 1968**



- Height 4-7/8"
- OEM ref#T3775

PART#	BULK PART#	DESCRIPTION
9391	9391Q	Diverter

OEM (Original Equipment Manufacturer) numbers, registered / non registered trademarks, faucet name, and manufacturer listed above are supplied and listed for your reference only. All LynCar items are precision made and tested to the highest standards, by qualified factories inspected and approved by LynCar.

FAUCET REPAIR

WALTEC

WALTEC HANDLES CROWN NEW STYLE



- Hot / cold pair
- CP Die Cast

WALTEC HANDLE LEVER



- Hot / cold pair
- New style lever handle for faucets
- Chrome plastic
- Inserts included
- OEM ref#76923

PART#	BULK PART#	DESCRIPTION
2050	2050Q	CROWN handles

PART#	BULK PART#	DESCRIPTION
2055	2055Q	Lever handles

WALTEC HANDLES FLOTROL STYLE CP PLASTIC



- Hot / cold pair
- CP plastic
- OEM ref#76540

WALTEC HANDLES FLOTROL STYLE METAL



- Hot / cold pair
- Die cast metal
- OEM ref#76540

PART#	BULK PART#	DESCRIPTION
2008	2008Q	Plastic

PART#	BULK PART#	DESCRIPTION
2009	2009Q	Metal

WALTEC HANDLES FLOTROL STYLE, LEVER



- Hot / cold pair
- CP plastic
- OEM ref#76570

WALTEC HANDLES STARBURST STYLE



- Hot / cold pair
- CP plastic
- OEM ref#76519

PART#	BULK PART#	DESCRIPTION
2007	2007Q	Lever, FLOTROL

PART#	BULK PART#	DESCRIPTION
953	953Q	STARBURST

OEM (Original Equipment Manufacturer) numbers, registered / non registered trademarks, faucet name, and manufacturer listed above are supplied and listed for your reference only. All LynCar items are precision made and tested to the highest standards, by qualified factories inspected and approved by LynCar.

WALTEC

WALTEC CARTRIDGE OLD STYLE (PRIOR TO 1990)



- Height 1-3/4
- OEM ref#76100 hot
- OEM ref#76101 cold

PART#	BULK PART#	DESCRIPTION
901	901Q	Hot
902	902Q	Cold

WALTEC CARTRIDGE NEW STYLE



- Height 1-3/4"
- OEM ref#96100 hot
- OEM ref#96101 cold

PART#	BULK PART#	DESCRIPTION
910	910Q	Hot
911	911Q	Cold

WALTEC CARTRIDGE PIONEER STYLE



- OEM ref#76763 hot
- OEM ref#76764 cold

PART#	BULK PART#	DESCRIPTION
945	945Q	Hot
946	946Q	Cold

WALTEC EXTENDED SEATS FOR TUB & SHOWER AND AUTO WASH



- 9/16 x 24 TPI x 1-1/2" long
- Chrome plated
- OEM ref#16392

PART#	BUPART#	DESCRIPTION
9478	9478Q	Extended seats

WALTEC SEAT ALSO FITS WALLACEBURG



- 9/16 x 24 TPI
- OEM ref#16500

PART#	BULK PART#	DESCRIPTION
947	947Q	Seat

OEM (Original Equipment Manufacturer) numbers, registered / non registered trademarks, faucet name, and manufacturer listed above are supplied and listed for your reference only. All LynCar items are precision made and tested to the highest standards, by qualified factories inspected and approved by LynCar.

WALTEC

WALTEC DIVERTER FOR STARBURST AND FLOTROL 4-1/4"



- Concealed tub & shower
- 4-1/4" long
- OEM ref#76655

PART#	BULK PART#	DESCRIPTION
938	938Q	Diverter

WALTEC DIVERTER FLOTROL TUB & SHOWER 4-7/8"



- 1970 -1973
- 4-7/8" long
- OEM ref#T25168

PART#	BULK PART#	DESCRIPTION
964	964Q	Diverter

WALTEC DIVERTER ASSEMBLY FOR STARBURST AND FLOTROL 2-5/8"



- Facemount tub & shower
- 2-5/8" long
- OEM ref#76305

PART#	BULK PART#	DESCRIPTION
951	951Q	Diverter assembly

WALTEC DIVERTER ASSEMBLY FOR STARBURST AND FLOTROL 2-3/4"



- Facemount tub & shower
- 2-3/4" long
- OEM ref#76341

PART#	BULK PART#	DESCRIPTION
952	952Q	Diverter assembly

FAUCET REPAIR

OEM (Original Equipment Manufacturer) numbers, registered / non registered trademarks, faucet name, and manufacturer listed above are supplied and listed for your reference only. All LynCar items are precision made and tested to the highest standards, by qualified factories inspected and approved by LynCar.

SPOUTS

**BELANGER KITCHEN DECK SPOUT
8" NEW STYLE AFTER 2005**



PART#	BULK PART#	DESCRIPTION
1173	1173Q	8" spout new style

**KITCHEN SPOUT FOR CUTHBERT
/BELANGER 8" OLD STYLE BEFORE
2005**



PART#	BULK PART#	DESCRIPTION
1174	1174Q	8" spout old style

**DELTA DECK SPOUT 8" FOR SINGLE
LEVER FAUCETS**



- OEM ref#RP-5654

PART#	BULK PART#	DESCRIPTION
12832	12832Q	8" spout

**EMCO KITCHEN REPLACEMENT
DECK SPOUT 8" SPOUT FOR
DORIC & CORONA DECK FAUCETS**



- OEM ref#51-1931005

PART#	BULK PART#	DESCRIPTION
1161	1161Q	8" spout

**MOEN REPLACEMENT DECK SPOUT
FITS CHATEAU SINGLE LEVER MODELS**



- OEM ref#7200 / 7500

PART#	BULK PART#	DESCRIPTION
12831	12831Q	Replacement deck

**FAUCET DECK SPOUTS FOR
MUELLER AND STERLING**



- 8" spouts

PART#	BULK PART#	DESCRIPTION
1164	1164Q	For MUELLER
1165	1165Q	For STERLING

**WALTEC 8" HIGHRISE DECK SPOUT
FITS MOST WALTEC PRODUCTS**



- Metal snap ring before 1977
- Nylon snap ring since 1977
- OEM ref#76363

PART#	BULK PART#	DESCRIPTION
1162	1162Q	Metal Ring
1163	1163Q	Nylon Ring

**WALTEC 8" NEW STYLE DECK SPOUT
FITS MOST WALTEC PRODUCTS
SINCE 1977**



- OEM ref#76541-1

PART#	BULK PART#	DESCRIPTION
1172	1172Q	8" new style

OEM (Original Equipment Manufacturer) numbers, registered / non registered trademarks, faucet name, and manufacturer listed above are supplied and listed for your reference only. All LynCar items are precision made and tested to the highest standards, by qualified factories inspected and approved by LynCar.

O-RING KITS

O - RING KIT 200 PIECES



PART#		DESCRIPTION			
2250		200 pc "o" ring kit contains 12 sizes			
Item	ID	OD	DIA	PCS	
44006	1/4	3/8	1/16	25	
44008	5/16	7/16	1/16	25	
44026	3/8	9/16	3/32	40	
44028	7/16	5/8	3/32	20	
44030	1/2	11/16	3/32	20	
44032	9/16	3/4	3/32	10	
44034	5/8	13/16	3/32	10	
44036	11/16	7/8	3/32	10	
44038	3/4	15/16	3/32	10	
44050	3/4	1	1/8	10	
44052	13/16	1-1/16	1/8	10	
44054	7/8	1-1/8	1/8	10	

O-RING KIT - 500 PIECES



PART#		DESCRIPTION			
2252		500 pc "o" ring kit contains 20 sizes plus 2oz faucet grease & o ring pick.			
Item	ID	OD	DIA	PCS	
44002	5/32	9/32	1/16	40	
44006	1/4	3/8	1/16	40	
44008	5/16	7/16	1/16	40	
44010	3/8	1/2	1/16	35	
44012	7/16	9/16	1/16	35	
44014	1/2	5/8	1/16	35	
44024	1-3/8	1-1/2	1/16	15	
44026	3/8	9/16	3/32	40	
44028	7/16	5/8	3/32	35	
44030	1/2	11/16	3/32	35	
44032	9/16	3/4	3/32	35	
44034	5/8	13/16	3/32	20	
44036	11/16	7/8	3/32	20	
44038	3/4	15/16	3/32	20	
44040	13/16	1	3/32	15	
44044	1-5/16	1-1/2	3/32	10	
44052	13/16	1-1/16	1/8	10	
44054	7/8	1-1/8	1/8	10	
44066	1-1/4	1-1/2	1/8	5	
44068	1-5/16	1-9/16	1/8	5	

FAUCET REPAIR

O-RINGS

O-RINGS - 1/16" THICK

Actual Size Selection Chart - 1/16" Thick

- The most popular o rings used in the plumbing industry
- Order by bags of 100 or mini packs of 25 pcs

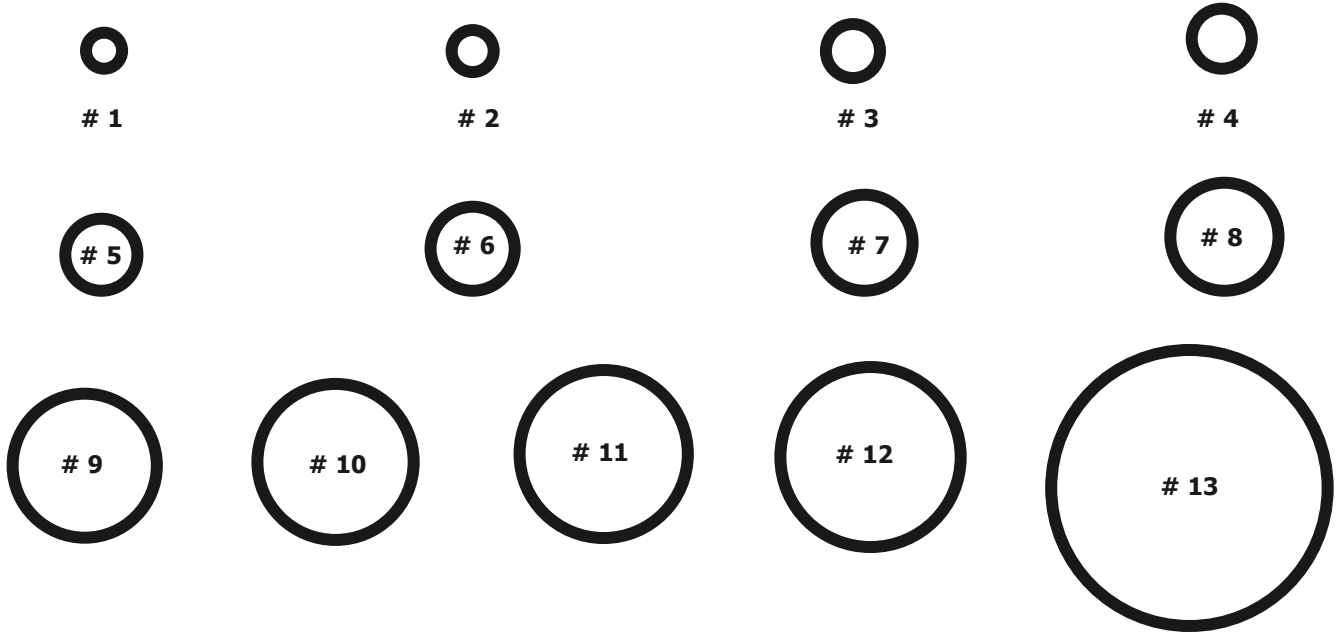

25 PK PART#	BULK PART#	PLANOGRAM	ID	OD	DIA	USED FOR
44000	44000Q	1	1/8	1/4	1/16	
44002	44002Q	2	5/32	9/32	1/16	CUTHBERT
44004	44004Q	3	7/32	11/32	1/16	
44006	44006Q	4	1/4	3/8	1/16	CUTHBERT, EMCO
44008	44008Q	5	5/16	7/16	1/16	CUTHBERT, MUELLER, WALLACEBURG
44010	44010Q	6	3/8	1/2	1/16	WALTEC
44012	44012Q	7	7/16	9/16	1/16	EMCO, WALLACEBURG
44014	44014Q	8	1/2	5/8	1/16	CUTHBERT
44016	44016Q	9	11/16	13/16	1/16	WALLACEBURG
44018	44018Q	10	3/4	7/8	1/16	WALTEC
44020	44020Q	11	13/16	15/16	1/16	
44022	44022Q	12	7/8	1	1/16	
44024	44024Q	13	1-3/8	1-1/2	1/16	

O-RINGS

D

O-RINGS - 3/32" THICK

Actual Size Selection Chart - 3/32" Thick

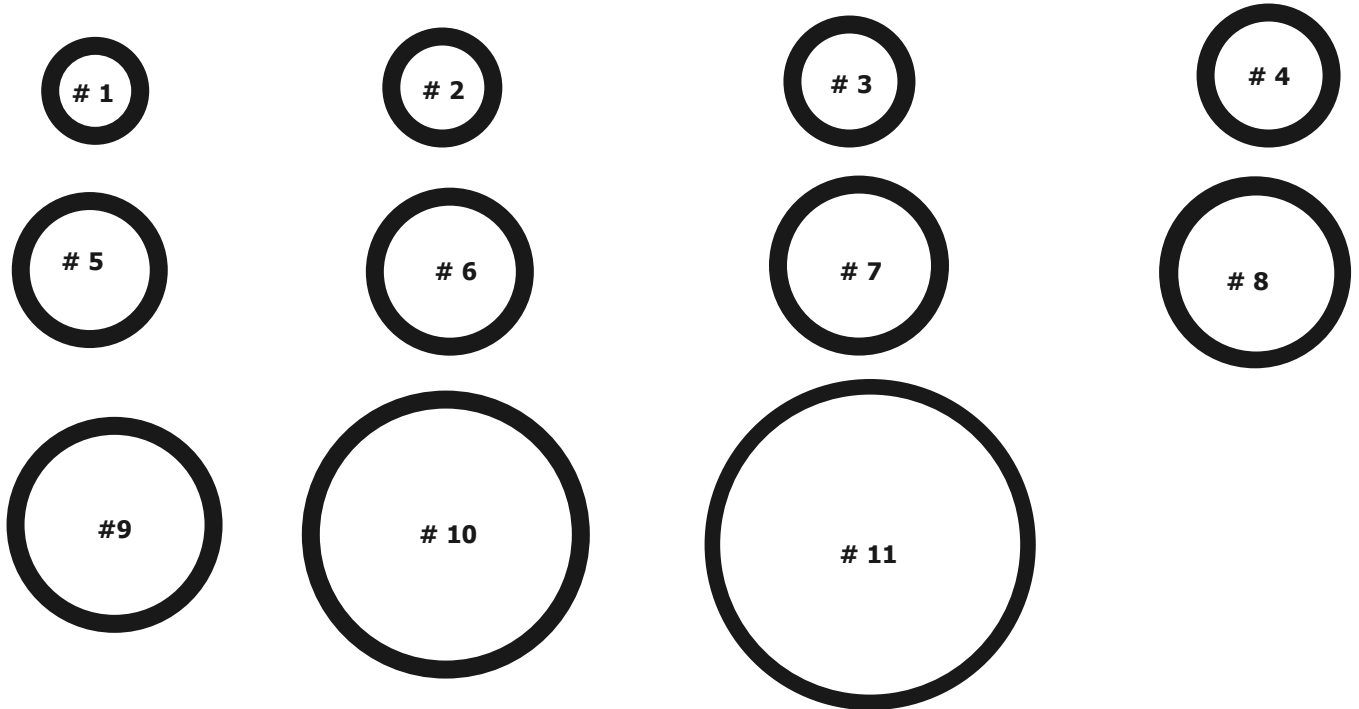

FAUCET REPAIR

25 PK PART#	BULK PART#	PLANOGRAM	ID	OD	DIA	USED FOR
44026	44026Q	1	3/8	9/16	3/32	CRANE, EMCO, CUTHBERT, JAMECO, STERLING, GALTMASTER, WALTEC
44028	44028Q	2	7/16	5/8	3/32	EMCO, WALTEC
44030	44030Q	3	1/2	11/16	3/32	
44032	44032Q	4	9/16	3/4	3/32	EMCO, MOEN, WALTEC
44034	44034Q	5	5/8	13/16	3/32	MOEN, GALTMASTER, WALTEC
44036	44036Q	6	11/16	7/8	3/32	
44038	44038Q	7	3/4	15/16	3/32	
44040	44040Q	8	13/16	1	3/32	EMCO
44042	44042Q	9	15/16	1-1/8	3/32	
44044	44044Q	10	1-5/16	1-1/2	3/32	
44046	44046Q	11	1-9/16	1-3/4	3/32	

O-RINGS

O-RINGS - 1/8" THICK

Actual Size Selection Chart - 1/8" Thick

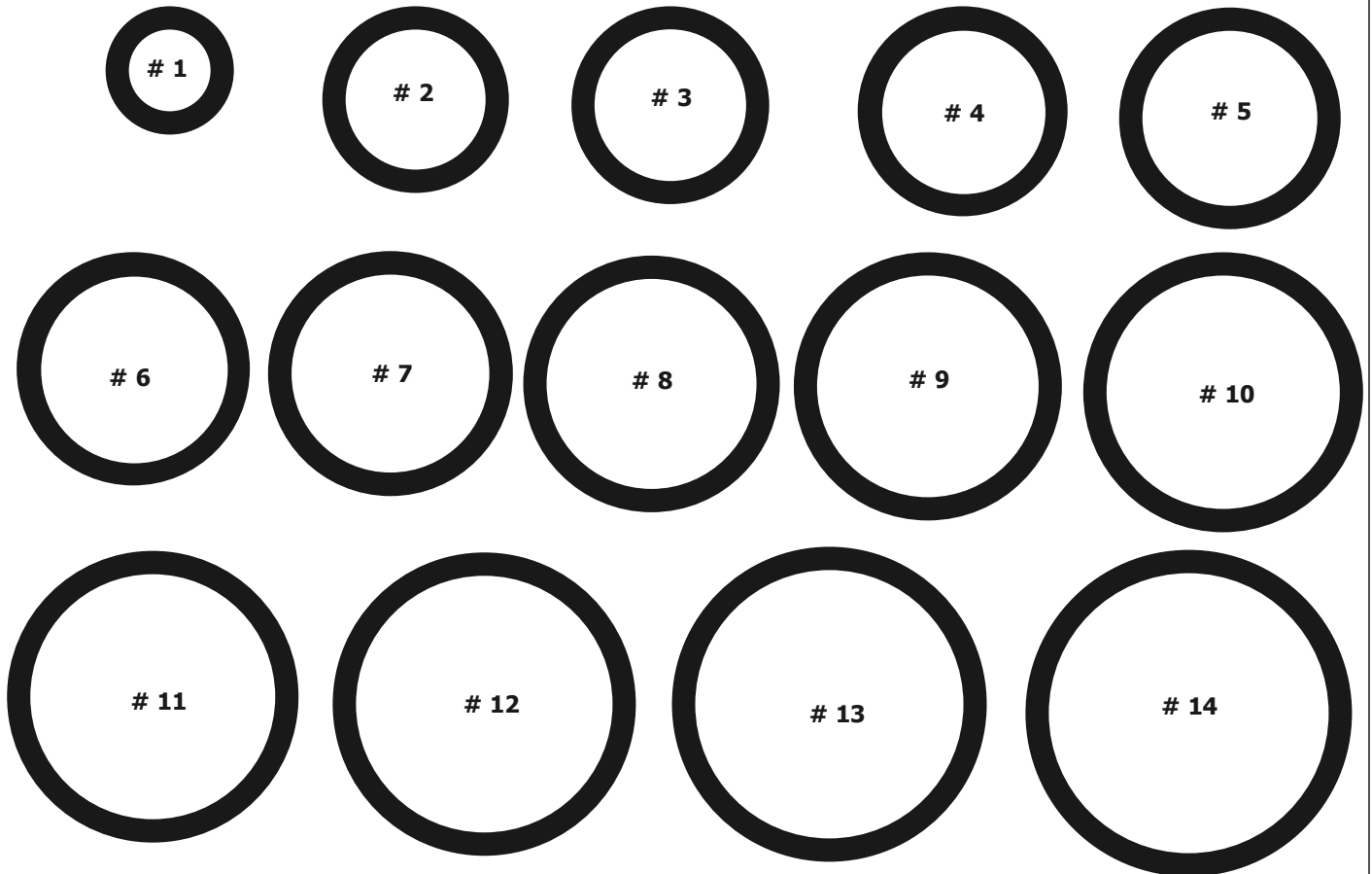

FAUCET REPAIR

25 PK PART#	BULK PART#	PLANOGRAM	ID	OD	DIA
44048	44048Q	1	7/16	11/16	1/8
44050	44050Q	2	3/4	1	1/8
44052	44052Q	3	13/16	1-1/16	1/8
44054	44054Q	4	7/8	1-1/8	1/8
44056	44056Q	5	15/16	1-3/16	1/8
44058	44058Q	6	1	1-1/4	1/8
44060	44060Q	7	1-1/16	1-5/16	1/8
44062	44062Q	8	1-1/8	1-3/8	1/8
44064	44064Q	9	1-3/16	1-7/16	1/8
44066	44066Q	10	1-1/4	1-1/2	1/8
44068	44068Q	11	1-5/16	1-9/16	1/8
44070	44070Q	12	1-3/8	1-5/8	1/8
44072	44072Q	13	1-7/16	1-11/16	1/8
44074	44074Q	14	1-1/2	1-3/4	1/8

O-RINGS

D

O-RINGS - 3/16" THICK

Actual Size Selection Chart - 3/16" Thick

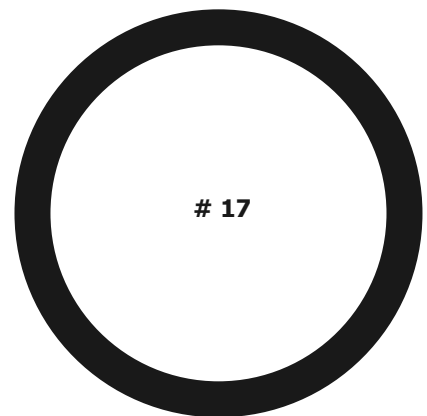
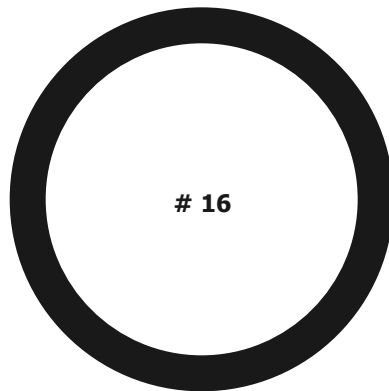
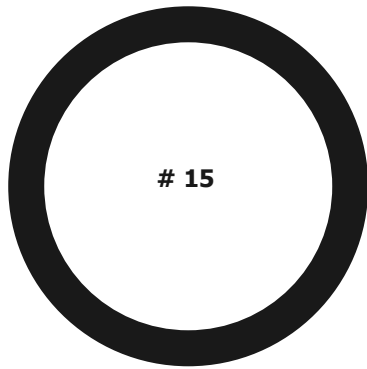

FAUCET REPAIR

25 PK PART#	BULK PART#	PLANOGRAM	ID	OD	DIA
44076	44076Q	15	1-1/2	1-7/8	3/16
44078	44078Q	16	1-5/8	2	3/16
44080	44080Q	17	1-3/4	2-1/8	3/16

FAUCET REPAIR

STEM GREASE



- Specially formulated for use on all metal faucets and valve stems carrying air, steam, and hot or cold water.
- Also lubricates ball cocks, plungers, packings and washers
- Can be used on potable water since it is safe and nontoxic

PART#	DESCRIPTION
3155	Stem grease

O-RING PICK



PART#	DESCRIPTION
5200	O-Ring pick

KORKY EASYSORT COLOURED FAUCET WASHERS



- KORKY coloured premium faucet washers
- Many sizes available
- Sold in retail pack, 6 pieces or bulk

FLAT PART#		BEVELED PART#		O.D.	TRADE DESCRIPTION	COLOUR
6 PK	BULK	6 PK	BULK			
12530	12530Q	12541	12541Q	1/2"	00	Dark brown
12531	12531Q	12542	12542Q	17/32"	0	Dark blue
12532	12532Q	12543	12543Q	9/16"	1/4	Dark green
12533	12533Q	12544	12544Q	19/32"	1/4L	Dark purple
12534	12534Q	12545	12545Q	5/8"	3/8	Grey
12535	12535Q	12546	12546Q	21/32"	3/8M	Violet
12536	12536Q	12547	12547Q	11/16"	3/8L	Orchid
12537	12537Q	12548	12548Q	3/4"	1/2	Hot pink
12538	12538Q			25/32"	1/2L	Teal
12539	12539Q	12555	12555Q	13/16"	5/8	Yellow
12553	12553Q			29/32"	5/8L	Light blue

BIBB WASHER KITS

FLAT WASHER KITS



- Flat washer kit
- 225 pieces
- LYNCAR black washers or KORXY premium coloured washers available

PART#	DESCRIPTION	PART#	DESCRIPTION			
2254	225 pcs, flat washer black 9 sizes	2254K	225 pcs, flat washer KORXY colour 9 sizes			
Item	Size	Pcs	Item	Colour	Size	Pcs
12500	00	35	12530	Dark Brown	00	35
12501	0	35	12531	Dark Blue	0	35
12502	1/4	35	12532	Dark Green	1/4	35
12503	1/4L	25	12533	Dark Purple	1/4L	25
12504	3/8	25	12534	Grey	3/8	25
12505	3/8M	25	12535	Violet	3/8M	25
12506	3/8L	15	12536	Orchid	3/8L	15
12507	1/2	15	12537	Hot Pink	1/2	15
12509	5/8	15	12539	Yellow	5/8	15

BEVELED WASHER KITS



- Beveled washer kit
- 215 pieces
- LYNCAR black washers or KORXY premium coloured washers available

PART#	DESCRIPTION	PART#	DESCRIPTION			
2256	215 pcs beveled washer black 9 sizes	2256K	215 pcs beveled washer KORXY colour 9 sizes			
Item	Size	Pcs	Item	Colour	Size	Pcs
12511	00	30	12541	Dark Brown	00	30
12512	0	30	12542	Dark Blue	0	30
12513	1/4	30	12543	Dark Green	1/4	30
12514	1/4L	25	12544	Dark Purple	1/4L	25
12515	3/8	25	12545	Grey	3/8	25
12516	3/8M	20	12546	Violet	3/8M	20
12517	3/8L	30	12547	Orchid	3/8L	30
12518	1/2	15	12548	Hot Pink	1/2	15
12520	5/8	10	12555	Yellow	5/8	10

BIBB & HANDLE

WASHER BIBB



FLAT PART#		BEVELED PART#		TRADE DESCRIPTION	O.D.
6 PK	BULK	6 PK	BULK		
12500	12500Q	12511	12511Q	00	1/2"
12501	12501Q	12512	12512Q	0	17/32"
12502	12502Q	12513	12513Q	1/4	9/16"
12503	12503Q	12514	12514Q	1/4L	19/32"
12504	12504Q	12515	12515Q	3/8	5/8"
12505	12505Q	12516	12516Q	3/8M	21/32"
12506	12506Q	12517	12517Q	3/8L	11/16"
12507	12507Q	12518	12518Q	1/2	3/4"
12508	12508Q	12519	12519Q	1/2L	25/32"
12509	12509Q	12520	12520Q	5/8	13/16"
12510	12510Q	12521	12521Q	5/8L	29/32"

SCREW - BULK BIBB & HANDLE SCREWS



25 PK PART#	BULK PART#	DESCRIPTION	HEAD
13300	13300Q	1/4" x 8-32	Round
13302	13302Q	3/8" x 10-32	Oval
13304	13304Q	1/2" x 10-24	Oval
13306	13306Q	1/2" x 10-24	Truss
13308	13308Q	1/2" x 8-32	Binding
13310	13310Q	1/2" x 8-32	Oval
13312	13312Q	1/2" x 8-32	Truss
13314	13314Q	3/4" x 10-24	Oval
13316	13316Q	3/4" x 10-32	Oval
13318	13318Q	3/4" x 8-32	Oval
13320	13320Q	3/4" x 10-32	Binding
13322	13322Q	3/4" x 10-24	Round
13324	13324Q	5/8" x 10-24	Oval
13326	13326Q	1" x 10-24	Truss
13328	13328Q	1" x 10-32	Truss

SCREW - BIBB & HANDLE SCREWS



25 PK PART#	BULK PART#	DESCRIPTION
13334	13334Q	3/8" x 8-32
13335	13335Q	1/2" x 8-32
13336	13336Q	3/8" x 10-32
13337	13337Q	1/2" x 10-32
13338	13338Q	3/8" x 10 -24
13339	13339Q	1/2" x 10-24

SIZING GAUGES

D

SEAT GAUGE



HANDLE GAUGE



PART#	DESCRIPTION
11320	Faucet seats gauge

PART#	DESCRIPTION
11321	Faucet handles gauge

AERATOR GAUGE



STEM GAUGE



PART#	DESCRIPTION
11322	Aerators gauge

PART#	DESCRIPTION
11325	Faucet stems gauge

FAUCET REPAIR

SCREW - BIBB & HANDLE KITS

HANDLE & BIBB SCREW KIT

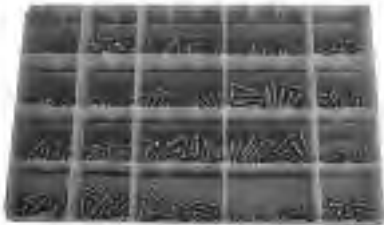

PART#	DESCRIPTION			
13330	300 pcs handle & bibb screw kit			
PART#	Use	Size	Head	Pcs
13300	Handle screw	1/4" x 8-32	Round	15
13302	Handle screw	3/8" x 10-32	Oval	15
13304	Handle screw	1/2" x 10-24	Oval	15
13306	Handle screw	1/2" x 10-24	Truss	15
13308	Handle screw	1/2" x 8-32	Binding	15
13310	Handle screw	1/2" x 8-32	Oval	15
13312	Handle screw	1/2" x 8-32	Truss	15
13314	Handle screw	3/4" x 10-24	Oval	15
13316	Handle screw	3/4" x 10-32	Oval	15
13318	Handle screw	3/4" x 8-32	Oval	15
13320	Handle screw	3/4" x 10-32	Binding	15
13322	Handle screw	3/4" x 10-24	Round	15
13324	Handle screw	5/8" x 10-24	Oval	15
13326	Handle screw	1" x 10-24	Truss	15
13328	Handle screw	1" x 10-32	Truss	15
13334	Bibb screw	3/8" x 8-32	Oval	15
13335	Bibb screw	1/2" x 8-32	Oval	15
13337	Bibb screw	3/8" x 10-32	Oval	15
13338	Bibb screw	1/2" x 10-32	Oval	15
13339	Bibb screw	3/8" x 10-24	Oval	15

BIBB SCREW KIT



PART#	DESCRIPTION		
13332	150 pc bibb screw kit		
PART#	Use	Size	Pcs
13334	Bibb screw	3/8" x 8-32	25
13335	Bibb screw	1/2" x 8-32	25
13336	Bibb screw	3/8" x 10-32	25
13337	Bibb screw	1/2" x 10-32	25
13338	Bibb screw	3/8" x 10-24	25
13339	Bibb screw	1/2" x 10-24	25

SHOWER HEADS

SHOWER HEAD - PEAR STYLE



- Chrome
- 3 function: spray, pulsating and jet settings
- Pear style
- Display packaged
- cUPC approved

PART#	DESCRIPTION
1201	3 function shower head

SHOWER HEAD - ADJUSTABLE, SOLID BRASS VANDAL RESISTANT



- Solid brass shower heads
- 2 sizes, 1-1/4" & 2-1/4"
- Vandal resistant models available
- Chrome finished
- cUPC approved

PART#	TYPE	FACE SIZE
2036	Standard	1-3/4" diameter
2037	Standard	2-1/4" diameter
2036VP	Vandal resistant	1-3/4" diameter
2037VP	Vandal resistant	2-1/4" diameter

SHOWER HEAD - DELUXE MASSAGE - CSA



- 1.5 GPM @ 60psi
- 3 function pulsating massage
- Fingertip control
- Display carded
- CSA approved

PART#	DESCRIPTION
1208	Chrome plated
1208BN	Brushed nickel

SHOWER HEADS

SHOWER HEAD - SUREFLOW



- 1/2" FPT
- Easily adjusts from fine to peppery spray
- Chrome plated brass ball joint
- 2.5 GPM @ 70 PSI
- Removable filter screen prevents clogging of spray
- SIMPLY THE BEST SHOWER HEAD
- CSA approved

SHOWER HEAD - SUREFLOW ALL CHROME



- 1/2" FPT
- Easily adjusts from fine to peppery spray
- Chrome plated brass ball joint
- 2.5 GPM @ 70 PSI
- Removable filter screen prevents clogging of spray
- SIMPLY THE BEST SHOWER HEAD
- CSA approved

PART#	DESCRIPTION
2001	Canadian style

PART#	DESCRIPTION
1167	All chrome

SHOWER HEAD - LYN CAR SUREFLOW ADJUSTABLE LOW FLOW AND VANDAL RESISTANT



- SUREFLOW model
- Low flow 1.5 GPM head
- Vandal resistant model
- CSA approved

SHOWER HEAD - SPEAKMAN STYLE



- Chrome plated brass
- 6 jet adjustment
- T handle spray adjustment
- 2.5 GPM output

PART#	DESCRIPTION
2002	Low flow, SUREFLOW head
2002VP	Low flow, SUREFLOW head, vandal resistant

PART#	DESCRIPTION
1204	Shower head - SPEAKMAN style

SHOWER HEADS

SHOWER HEAD - SUNFLOWER



- Solid brass
- 5" diameter
- 44 beads of spray
- Chrome or gold finish
- cUPC approved



PART#	DESCRIPTION
-------	-------------

- | | |
|-------------|---------------------|
| 3210 | Chrome plated brass |
| 3211 | Gold plated brass |

SHOWER HEAD NIAARA CONSERVATION



- 9-jet turbo massage is adjustable: gentle needle spray to forceful jet
- Consistent flow rate regardless of water pressure
- Saves 40% more water & energy than a standard 2.5 GPM showerhead
- Non-aerating spray means less temperature loss
- Self-cleaning & maintenance-free
- Corrosion-resistant, high-impact ABS thermoplastic body
- Meets or exceeds ANSI specifications
- 10-year guarantee
- CSA approved



PART#	DESCRIPTION
-------	-------------

- | | |
|---------------|--------------------------|
| 1169CH | Chrome |
| 1169 | White |
| 1169V | White - vandal resistant |

SHOWER HEAD HAND HELD NIAARA CONSERVATION



- Flow rate @ high PSI:1.5 GPM
- Flow rate @ low PSI:1.0 GPM
- Stream type:spray, massage & combo
- Adjustable angle:yes
- Type of control:pressure compensator
- Head length:3-5/16" (84 mm)
- Handheld length:8-11/16" (221 mm)
- Mounting type:hand held with wall mount bracket head
- Diameter:2-11/16" (68 mm)
- Nozzle quantity:9-45 (spray dependant)
- Finish:chrome



PART#	DESCRIPTION
-------	-------------

- | | |
|---------------|-----------|
| 2945CH | Hand held |
|---------------|-----------|

SHOWER HEAD ALL DIRECTIONAL ARM



- Downpour rainshower head
- Adjustable arm 9"
- 3-1/2" diameter head
- Adjustable arm
- Several finishes available

PART#	FINISH
-------	--------

- | | |
|-------------|--------------|
| 3200 | Chrome |
| 3201 | White |
| 3202 | Satin |
| 3203 | Polish brass |

SHOWER HEAD - ECONOMY



- 1/2" FPT
- 2.75 GPM @ 70 PSI
- Adjustable
- Chrome finish
- Economy CP plastic
- Brass ball



PART#	DESCRIPTION
-------	-------------

- | | |
|----------------|-----------------------|
| 1189CSA | Shower head - economy |
|----------------|-----------------------|

TUB AND SHOWER

SHOWER HOSE



- 1/2" x 1/2"
- Double lock hose with conical end in chrome
- Our armoured metal hoses are double locked
- Double lock makes for a much stronger, longer lasting hose
- Premium quality shower hose
- NSF approved



PART#	LENGTH	FINISH
55548	48"	Chrome
55560	60"	Chrome
55560BN	60"	Brushed nickel
55572	72"	Chrome
55572BN	72"	Brushed nickel
55584	84"	Chrome

SHOWER HIGH RISE ARM



- Increases height of any shower head
- Chrome plated brass
- 10" length x 1/2" IPS
- Sold less shower head

PART#	LENGTH
1190	10" - "S" arm & flange
1191	8" - "S" arm & flange

SHOWER - ADJUSTABLE ARM



- 1/2" MPT x 1/2" FPT
- 10" length
- Chrome plated brass
- Locking wingnuts allow
- Any height adjustment
- Shower head not included

PART#	DESCRIPTION
1192	Shower - adjustable arm

"L" BEND SHOWER ARM 1/2 IPS 90°



- 1.6 mm brass
- Highest quality
- Flange included

PART#	DESCRIPTION
1194	10" - "L" arm
119417	17" - "L" arm
119417BN	17" - "L" arm brushed nickel

TUB AND SHOWER

SHOWER ARMS



- 1.6 mm brass
- Highest quality

PART#	FINISH	SIZE
1185	Chrome	6"
1186	Chrome	8"
1193	Chrome	10"
1185PB	Polished brass	6"
1186PB	Polished brass	8"
1185BN	Brushed nickel	6"
1186BN	Brushed nickel	8"
1193BN	Brushed nickel	10"
1185ORB	Oil rub bronze	6"
1186ORB	Oil rub bronze	8"

ROUGH IN SHOWER TEST NIPPLE



- Performs your test before shower installation
- Threads into wing back 90 degrees
- Reusable plastic
- PEX drop ear elbow (**part#69521**) not included (**see page g-1**)

PART#	DESCRIPTION
4760	Shower test nipple

SHOWER ARM FLANGE SURE GRIP



- Slip on flanges
- For shower arms
- Several finishes available

PART#	FINISH
1182	Chrome
1182PB	Polished brass
1182BN	Brushed nickel

SHOWER ARM FLANGE SET SCREW



- Different finishes available
- With set screw

PART#	FINISH
1187	Chrome
1187PB	Polished brass
1187BN	Brushed nickel
1187ORB	Oil rubbed bronze

TUB AND SHOWER

SHOWER - ARM & FLANGE PACKS



- 1.6 mm thick 6" shower arm with SURE GRIP flange
- Shower packs with 6" brass shower arm & SURE GRIP shower flange

PART#	FINISH	DESCRIPTION
1189	Chrome	Arm & flange
1189BN	Brushed nickel	Arm & flange
11895	Polished brass	Arm & flange

SHOWER - HEAD, ARM & FLANGE PACKS



- Head, arm & flange packs with 6" brass shower arm, SURE GRIP shower flange & several choices of shower heads available
- Commonly known as builder kits
- CSA approved

PART#	DESCRIPTION	HEAD
1196CSA	With C.P. plastic CSA economy head(shown)	1189CSA
11964	With "SUREFLOW" head	2001
11965	With "SUREFLOW" all chrome head	1167
12085	With deluxe CSA chrome head	1208

SHOWER - COMPLETE TRIM PACKS, WITH ECONOMY HEAD



- All kits include: tub spout, shower arm 6", flange and shower head
- Boxed packaged kit
- Choose your spout and shower head
- CSA approved

PART#	SHOWER HEAD	TUB SPOUT	FINISH
1199CSA	Economy (part#1189CSA)	Slip fit (part#1142)	Chrome
1198	Economy (part#1189CSA)	Front mounting (part#1128)	Chrome
1199BN	Adjustable massage (part#1208BN)	Slip fit (part#1142BN)	Brushed Nickel

SHOWER - COMPLETE TRIM PACKS, WITH SUREFLOW HEAD



- CSA approved

PART#	SHOWER HEAD	TUB SPOUT
1199Tk	SUREFLOW (part#2001)	Slip fit (part#1142)
1198Tk	SUREFLOW (part#2001)	Front mounting (part#1128)
1167Tk	SUREFLOW (part#1167)	Slip fit (part#1142)

TUB AND SHOWER

SHOWER ARM EI BOW



- This brass elbow securely mounts a shower arm to a fiberglass shower stall
- Can be used to secure a tub spout nipple. Can be used with copper, iron pipe or compression fittings
- Prevents movement of shower arm & tub spout
- Locknuts secure elbow to fiberglass wall
- Requires 1-1/32" hole through fiberglass
- Outlet end 1/2" FIP
- Inlet end 1/2" CWT / MPT, 1/2 PEX
- PEX end also available in 1/2" & 3/4" (see page g-8)

PART#	dEScription
1195	1/2" CWT / MPT
1195Q	1/2" CWT / MPT - bulk

BATHCOCK EI BOW



- 1/2" MPT
- Satin finish brass
- Sold by the pair

PART#	dEScription
1793	Bathcock Elbow

SUPPLY - CRAWFOOT BATH TUBS



- 2 styles with nuts & washers
- 1/2" chrome plated copper
- Sold per pair in boxes

PART#	dEScription
1792	90° single bend For 3-3/8" centers
17925	Offset bend for 3-3/8" to 4" centers

ROUGH BRASS TWIN EI BOW



- Double quarter turn brass elbow
- 3/4" x 1/2" x 1/2"
- Use on diverter spout 3/4" to 1/2" shower

PART#	dEScription
1145	Rough brass twin elbow

TUB AND SHOWER

**PUSH CONTROL SHOWER
dIVERTER VALVE**



- Push-down, pull-up diverter valve changes the direction of water flow
- Very high quality construction & finish
- Standard 1/2" thread size
- Material: solid brass, all metal construction

SHOWER ARM SHUT OFF



- 1/2" MPT x 1/2" FPT
- Chrome plated brass
- Shower head will still dribble after shut off to prevent back flow

PART#	dESCRPTION
1166B	Push control shower diverter valve chrome plated brass

PART#	dESCRPTION
1168	Shower arm shut off

SHOWER ARM dIVERTER



- Two 1/2" MPT with one 1/2" FPT
- Chrome plated ABS plastic
- Allows connection of hand held shower

**SHOWER ARM / HOSE COMBO
dIVERTER**



- Two 1/2" MPT with one 1/2" FPT
- Chrome plated brass body, ABS handle
- Allows connection of hand held shower

PART#	dESCRPTION
1166	Shower arm diverter, ABS

PART#	dESCRPTION
2267	Shower arm & hose diverter

TUB SPOUTS

TUB SPOUT



- Chrome plated brass or die cast
- 5-5/8" length
- CSA approved



PART#	MATERIAL	FINISH	MOUNT	FPT	APPROVAL
1115	Brass	Chrome	Front	1/2"	-
1126	Brass	Chrome	Back	1/2" - 3/4"	-
1134	Die cast	Chrome	Front	1/2"	CSA
1134PB	Die cast	Pol. brass	Front	1/2"	CSA

TUB SPOUT WITH dIVERTER



- Thread in front
- Chrome plated brass or die cast
- 5-5/8" length front mount
- Front mount diverter
- CSA approved



PART#	MATERIAL	FINISH	FPT	APPROVAL
1117	Brass	Chrome	1/2"	-
1128	Die cast	Chrome	1/2"	CSA
1128PB	Die cast	Pol. brass	1/2"	-

TUB SPOUT - AdjUSTABLE



- Chrome plated die cast 5-5/8" Length
- With or without diverter (front)
- Several finishes available
- CSA approved



PART#	FINISH	AdjUST	dIVERTER	PIPE SIZE
1136	Chrome	2-1/4"	No	"SLIP FIT"
1136BN	Brushed nickel	2-1/4"	No	"SLIP FIT"
1142	Chrome	2-1/4"	Yes	"SLIP FIT"
1142BN	Brushed nickel	2-1/4"	Yes	"SLIP FIT"
1142PB	Polished brass	2-1/4"	Yes	"SLIP FIT"
1143	Chrome	1"	No	1/2" - 3/4" FPT
1144	Chrome	1"	Yes	1/2" - 3/4" FPT

HAND HEL d SHOWER SPOUT WITH dIVERTER



- Chrome plated die cast spouts
- With diverter, back
- With top or side adapter for shower hose
- 1/2" male hose adapter
- 1/2"-3/4" IPS back mount
- Protrusion from wall: 5-1/8"
- FPT: 1/2" or 3/4"

PART#	SHOWER OUTLET
1133	Top
1133S	Side

TUB SPOUTS

WALTEC STYLE TUB SPOUT



- Chrome plated die cast - 5-5/8" length
- With plastic insert to accept WALTEC tub nipple
- CSA approved

PART#	FINISH	divERTER
1135	Chrome	Yes
1132	Chrome	No

SPOUT - divERTER, BACK MOUNT



- Chrome plated brass or die cast
- 5-5/8" length back mount
- CSA approved

PART#	MATERIAL	FTP	APPROVAL
1127	Brass	1/2"	-
1129	Brass	3/4"	-
1137	Die cast	1/2"	CSA
1138	Die cast	3/4"	CSA
1140	Die cast	1/2"-3/4"	CSA

TUB SPOUT - 7" LONG



- Chrome or brushed nickel
- 7" spout, plated die cast, with or without diverter
- CSA approved

PART#	divERTER	FINISH	PIPE SIZE	STYLE
11287	Yes	Chrome	1/2" IPS	Front
11347	No	Chrome	1/2" IPS	Front
11367	No	Chrome	1/2" CWT	Slip
11367BN	No	Brushed nickel	1/2" CWT	Slip
11427	Yes	Chrome	1/2" CWT	Slip
11427BN	Yes	Brushed nickel	1/2" CWT	Slip

TUB SPOUT - 9" LONG, SOLID BRASS



- 9" spout, chrome plated brass
- Front style

PART#	divERTER	PIPE SIZE
1115E	No	1/2" IPS
1117E	Yes	1/2" IPS

TUB SPOUTS

dIy UNIVERSAI TUB SPOUT kITS



- Blister pack includes adapters, allen wrench & teflon tape
- Fits all existing plumbing: 3/4" thread, 1/2" thread, 1/2" copper slip fit, 1/2" thread in nose
- CSA approved



PART#	d ESCRIPTIONION
-------	-----------------

- | | |
|-------------|---------------|
| 1113 | No diverter |
| 1114 | With diverter |

MIXET STYI E SPOUTS



- Front spring diverter, for positive action shut
- CSA approved
- Slip on tub spout; with set screw
- Chrome plated finish
- CSA approved



PART#	d ESCRIPTIONION
-------	-----------------

- | | |
|--------------|-------------------|
| 1400 | 5-1/8" long model |
| 14001 | 7" long model |

dEI UxE STYI E TUB SPOUTS



- Deluxe style 6" tub spout
- With diverter at front
- Front thread or slip fit models
- CSA approved



PART#	d ESCRIPTIONION
-------	-----------------

- | | |
|----------------|---------------------------------------|
| 1403 | Front mounting connection |
| 1404 | Slip fit connection chrome |
| 1404BN | Slip fit connection brushed nickel |
| 1404ORB | Slip fit connection oil rubbed bronze |

WATERFAI I SPOUT



- Decorative waterfall spout with or without diverter
- CSA approved
- Fits all existing plumbing: 3/4" thread, 1/2" thread, 1/2" copper slip fit, 1/2" thread in nose
- 6" overall length
- 3-7/8" wide at the back and 3" wide at the front
- Chrome and brushed nickel available
- CSA approved



PART#	d ESCRIPTIONION
-------	-----------------

- | | |
|----------------|------------------------------|
| 11387 | Chrome with diverter |
| 11387BN | Brushed nickel with diverter |
| 11389 | Chrome less diverter |
| 11389BN | Brushed nickel less diverter |

TUB AND SHOWER

SPOUT RINGs



- LYNCAR spout rings take a standard LYNCAR tub spout (and most of our competitors models) & turns it into a decorative tub spout
- Two uses: for your customer its a decorative tub spout, for you, you have fixed the "gap" between the spout & the wall

PART#	dESCRIPTION
1116	Chrome
1116BN	Brushed nickel

dIVERTER I FT REPI ACEMENT



- Fits spouts: **part#1128, part#11287, part#11427, part#1142 & part#1144**
- Brass lift
- Rubber washer
- Plastic slide
- Installs in seconds

PART#	dESCRIPTION
1109	Diverter lift replacement

TUB SPOUT BUSHINGs



PART#	MATERIAI	SIZE
1139	Plastic	3/4" IPS x 1/2" IPS
1141	Brass	3/4" IPS x 1/2" IPS
1146	Brass	1/2" IPS x 3/8" IPS

TUB - FAUCET NIPPI ES



PART#	dESCRIPTION	MATERIAI
1110	1/2" x 3-1/4" use for EMCO (OEM ref#51-194387)	Brass
1111	1/2" x 4-1/2" all purpose	Brass
1112	1/2" x 7" use for BELANGER	Brass
11315	Multi use plastic 3 1/4" long, includes threads 3/8" for PRICE PFISTER, 5/8" x 18 TPI & 5/8" x 24 TPI - CRANE, KOHLER, STERLING 9/16" x 20 TPI for AM-STD, ELJER	Plastic

TUB AND SHOWER

TENSION SHOWER ROD



- Twist to expand tension shower rod
- Adjustable 36" - 63"
- 6 per carton
- Individually wrapped & bar coded

PART#	DESCRIPTION
1291	White
1292	Chrome
1293	Brass

SHOWER ROD - STRAIGHT



- 1" O.D. aluminum rod
- Polished aluminum shower rod with 5ft or 6ft lengths
- Packed 12 per box for your convenience
- Flange and hooks not included (see page E-15)

PART#	DESCRIPTION
1260	5ft long rod
1261	6ft long rod

BRASS SHOWER ROD, SPECIAL FINISHES



- Premium shower rods
- Brass pipe 1" diameter
- Plated & brushed
- Packed with flanges 1 set per box

PART#	DESCRIPTION
12608	Brushed nickel plated
12609	Oil rubbed bronze

BATHTUB SPIASH GUARDS



- White plastic
- 2 sizes available
- Packaged for display, sold by the pair

PART#	DESCRIPTION
15214	7" x 7"
15215	7" x 9"

TUB AND SHOWER

CURVED SHOWER ROD



- Very popular curved shower rod from LYNCAR is available in a retail box or as bulk contractor packs
- Increase the shower space in your bathtub
- Fits all standard tubs



PART#	DESCRIPTION	BOX PACK
1280	5 ft chrome steel with hardware	1
1280Q	5 ft chrome steel 12 unit contractor pack	12
1280BN	5 ft brushed nickel with hardware	1
1280BNQ	5 ft brushed nickel 12 unit contractor pack	12
1281	6 ft chrome steel with hardware	1
1281Q	6 ft chrome steel 12 unit contractor pack	12

RETROFIT PLATE FOR CURVED SHOWER ROD



- Part#1280Hk is included with 1 pack of the curved rod (shown above)
- Existing holes from previous shower rod installation are covered
- No additional fasteners are required

PART#	DESCRIPTION
1280Hk	4-3/4" wide x 3-1/2" height

CURVED SHOWER ROD - 3 PIECE



- Compact design for reduced shelf space
- Three sections 1" rod
- Fits standard 5ft tubs
- Chrome finish
- Box packaged

PART#	DESCRIPTION
1299	Curved shower rod 3 piece unit







QUICK VALVE PLATE

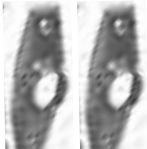

- Old ceramic tile is impossible to match
- The Quick Valve Plate covers the unsightly hole left in the tile after the shower valve is replaced
- Stainless steel
- Part#815 fits MOEN & DELTA & is our #1 seller
- Screws & brackets provided
- Polished stainless steel not affected by household cleaners 13" long x 7-1/4" wide

PART#	DESCRIPTION	HOLES	HOLE SIZE OR CENTRES
815	Stainless	1	5"
815PB	Polished brass	1	5"
815BN	Brushed nickel	1	5"
816	Stainless	2	5"
817	Stainless	3	8" centres
818	Stainless	1	3-1/2"
819	Stainless	1	4-1/2"
820	Stainless	0	No holes

TUB AND SHOWER

<p>PRESS FIT</p>  <ul style="list-style-type: none"> - Die cast metal or plastic - Press fit - Chrome or brushed nickel 	<p>FI ANgE</p>  <ul style="list-style-type: none"> - Oblong shower flange - Chrome plastic - With screws - 4-1/2" x 1-5/8" 																
<table border="1"> <thead> <tr> <th>PART#</th> <th>dEScription</th> </tr> </thead> <tbody> <tr> <td>1252</td> <td>Die cast, chrome</td> </tr> <tr> <td>1252BN</td> <td>Die cast, brushed nickel</td> </tr> <tr> <td>1253</td> <td>Plastic, chrome plated</td> </tr> </tbody> </table>	PART#	dEScription	1252	Die cast, chrome	1252BN	Die cast, brushed nickel	1253	Plastic, chrome plated	<table border="1"> <thead> <tr> <th>PART#</th> <th>dEScription</th> </tr> </thead> <tbody> <tr> <td>1255</td> <td>Oblong flange</td> </tr> <tr> <td>1255Q</td> <td>Oblong flange - bulk</td> </tr> </tbody> </table>	PART#	dEScription	1255	Oblong flange	1255Q	Oblong flange - bulk		
PART#	dEScription																
1252	Die cast, chrome																
1252BN	Die cast, brushed nickel																
1253	Plastic, chrome plated																
PART#	dEScription																
1255	Oblong flange																
1255Q	Oblong flange - bulk																
<p>SHOWER FI ANgE ROUND</p>  <ul style="list-style-type: none"> - Round chrome shower flanges - Stamped steel - 1-3/8" diameter - Shower rod has extra hold with set screw <table border="1"> <thead> <tr> <th>PART#</th> <th>dEScription</th> </tr> </thead> <tbody> <tr> <td>1254</td> <td>Shower rod metal</td> </tr> <tr> <td>1254Q</td> <td>Shower rod metal - bulk</td> </tr> <tr> <td>1254BN</td> <td>Shower rod metal brushed nickel</td> </tr> <tr> <td>1254BNQ</td> <td>Shower rod metal brushed nickel - bulk</td> </tr> </tbody> </table>	PART#	dEScription	1254	Shower rod metal	1254Q	Shower rod metal - bulk	1254BN	Shower rod metal brushed nickel	1254BNQ	Shower rod metal brushed nickel - bulk	<p>jUMBO STEEL</p>  <ul style="list-style-type: none"> - Oversized shower flange - Die cast steel - Shower rod has extra hold with set screw - 5-1/8" x 1-5/8" <table border="1"> <thead> <tr> <th>PART#</th> <th>dEScription</th> </tr> </thead> <tbody> <tr> <td>1257</td> <td>Jumbo CP die cast</td> </tr> <tr> <td>1257Q</td> <td>Jumbo CP die cast - bulk</td> </tr> </tbody> </table>	PART#	dEScription	1257	Jumbo CP die cast	1257Q	Jumbo CP die cast - bulk
PART#	dEScription																
1254	Shower rod metal																
1254Q	Shower rod metal - bulk																
1254BN	Shower rod metal brushed nickel																
1254BNQ	Shower rod metal brushed nickel - bulk																
PART#	dEScription																
1257	Jumbo CP die cast																
1257Q	Jumbo CP die cast - bulk																
<p>CURTAIN RINGs W/ BRASS ROl lERS</p>  <ul style="list-style-type: none"> - Solid brass - Shower curtain rings - Rust resistant roller balls make sliding shower curtains easy - 12 rings per package <table border="1"> <thead> <tr> <th>PART#</th> <th>dEScription</th> </tr> </thead> <tbody> <tr> <td>1184</td> <td>C.P. brass rollers</td> </tr> </tbody> </table>	PART#	dEScription	1184	C.P. brass rollers	<p>CURTAIN RINGs</p>  <ul style="list-style-type: none"> - Aluminum rings for shower curtain - Style #3 - 12 rings per package <table border="1"> <thead> <tr> <th>PART#</th> <th>dEScription</th> </tr> </thead> <tbody> <tr> <td>1188</td> <td>Plain #3 ring</td> </tr> </tbody> </table>	PART#	dEScription	1188	Plain #3 ring								
PART#	dEScription																
1184	C.P. brass rollers																
PART#	dEScription																
1188	Plain #3 ring																
<p>SHOWER HOOK UP kIT WITH OBl ONg FI ANgE</p>  <ul style="list-style-type: none"> - Complete shower curtain and rod hook up kit - Chain, hook, rings and flange - With part#1255 oblong flange <table border="1"> <thead> <tr> <th>PART#</th> <th>dEScription</th> </tr> </thead> <tbody> <tr> <td>1183</td> <td>Complete with oblong flange</td> </tr> </tbody> </table>	PART#	dEScription	1183	Complete with oblong flange	<p>SHOWER HOOK UP kIT WITH PRESS FIT FI ANgE</p>  <ul style="list-style-type: none"> - Complete shower curtain and rod hook up kit - Chain, hook, rings and flange - With part#1253 CP plastic fit flange <table border="1"> <thead> <tr> <th>PART#</th> <th>dEScription</th> </tr> </thead> <tbody> <tr> <td>1181</td> <td>Complete with press fit flange</td> </tr> </tbody> </table>	PART#	dEScription	1181	Complete with press fit flange								
PART#	dEScription																
1183	Complete with oblong flange																
PART#	dEScription																
1181	Complete with press fit flange																

TUB AND SHOWER ESCUTCHEONS

SHOWER ESCUTCHEONS - MOEN



- Replacement shower valve
- Escutcheons to fit MOEN
- Flat or recessed styles
- Replacement tube is **part#11290**

PART#	d DESCRIPTION
-------	---------------

11280	Escutcheon for MOEN 7" flat, chrome
11285	Escutcheon for MOEN 7" recessed, chrome
11290	Tube flange for MOEN escutcheon

SHOWER ESCUTCHEONS - d EI TA

part# 11240



part# 11245



- Replacement shower valve
- Escutcheons to fit DELTA
- 6-3/4" round OEM ref#RP5883
- Rectangular for SCALDGUARD OEM ref#RP6205

PART#	d DESCRIPTION
-------	---------------

11240	Escutcheon for DELTA 6-3/4" chrome
11245	Escutcheon for DELTA scaldguard

SHOWER ESCUTCHEON - MIXET



- Shower escutcheon for MIXET
- 5-1/2" diameter chrome plastic
- OEM ref#MTR-5CLR

PART#	d DESCRIPTION
-------	---------------

11281	Escutcheon 5-1/2" chrome plastic
--------------	----------------------------------

SHOWER ESCUTCHEON - POWERS CRANE



- Shower escutcheon for POWERS CRANE
- Fits 800/900 models

PART#	d DESCRIPTION
-------	---------------

11283	Round 6-1/2" shower plate
--------------	---------------------------

SHOWER ESCUTCHEONS - SyMMONS



- SYMMONS shower escutcheons
- Available with plate A, B or C
- Model A = diverter control OEM ref#T29
- Model B = shower only OEM ref#T29B
- Model C = volume control OEM ref#T29C

PART#	d DESCRIPTION
-------	---------------

11336	With model "A" plate
11332	With model "B" plate
11329	With model "C" plate

OEM (Original Equipment Manufacturer) numbers, registered / non registered trademarks, faucet name, and manufacturer listed above are supplied and listed for your reference only. All LynCar items are precision made and tested to the highest standards, by qualified factories inspected and approved by LynCar.

SHOWER TRIM KITS

DELTA SHOWER TRIM KITS



- Replacement trim kit for DELTA shower valves
- Available in chrome or brushed nickel
- Blister packaged
- Two handle options, round acrylic, or die cast lever
- Kit replaces DELTA 600 series (#70 or #212 ball) and DELTA MONITOR 14 series.
- Includes faceplate, 2 handles, screws, adapters and Allen wrench

PART#	DESCRIPTION
-------	-------------

- | | |
|----------------|----------------|
| 11368 | Chrome |
| 11368BN | Brushed nickel |

MIXET SHOWER TRIM KITS



- MIXET shower escutcheons
- 5-1/2" shower escutcheon, chrome
- Inner handle metal or plastic
- OEM ref#MTR4

PART#	DESCRIPTION
-------	-------------

- | | |
|--------------|--|
| 11362 | MIXET trim kit with clear plastic inner handle |
| 11363 | MIXET trim kit with chrome inner handle |

MOEN SHOWER TRIM KITS



- Replacement trim kit for DELTA shower valves
- Available in chrome or brushed nickel
- Blister packaged
- Two handle options, round acrylic, or die cast Lever
- Kit replaces MOEN legend mentrol 2200, 2400, 2600 and 2700 series
- MOEN POSI TEMP(R) series and CHATEAU models
- Includes faceplate, 2 handles, screws, adapters and Allen wrench

PART#	DESCRIPTION
-------	-------------

- | | |
|----------------|----------------|
| 11369 | Chrome |
| 11369BN | Brushed nickel |

SYMMONS SHOWER TRIM KITS



- SYMMONS trim kits
- Includes handle, lever, faceplate, escutcheon, dome, and hardware
- Less shower head/arm
- OEM ref#S-96 series

PART#	DESCRIPTION
-------	-------------

- | | |
|--------------|------------------------------------|
| 11364 | Model A with handle / lever / dome |
| 11365 | Model B with handle / lever / dome |
| 11366 | Model C with handle & dome |

SHOWER RODS

SHOWER - ROD CORNER



- 1" diameter
- Jumbo flanges & 36" ceiling support
- Individually boxed

PART#	ROD LENGTH	DESCRIPTION
1262	60" x 27"	Polished aluminum
1263	72" x 27"	Polished aluminum
1284	60" x 27"	Chrome plated brass
1285	72" x 27"	Chrome plated brass

SHOWER - ROD d STYLE



- 1" diameter
- Round flanges & 36" ceiling support
- Individually boxed

PART#	ROD LENGTH	DESCRIPTION
1264	54" x 27"	Polished aluminum
1265	60" x 27"	Polished aluminum
1286	54" x 27"	Chrome plated brass
1287	60" x 27"	Chrome plated brass

SHOWER - ROD RECTANGULAR



- 1" diameter
- 1-36" ceiling support
- 1-10" wall support
- Round flanges
- Individually boxed

PART#	LENGTH x WIDTH	DESCRIPTION
1271	48" x 27"	Polished aluminum
1272	54" x 27"	Polished aluminum
1288	48" x 27"	Chrome plated brass
1289	54" x 27"	Chrome plated brass

SHOWER ROD CEILING SUPPORT

36" FIT-ALL CEILING SUPPORT COMPLETE

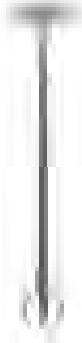

PART#	DESCRIPTION
1259	36" FIT-ALL ceiling support complete

HINGED CEILING SUPPORT FOR ANGLED CEILINGS



PART#	DESCRIPTION
1245	Hinged ceiling support for angled ceilings

1" LOOP



PART#	DESCRIPTION
1267	1" loop ONLY

ROD HOLDER, ANGLED



- Fits 1" shower rod

PART#	DESCRIPTION
1248	Angled ceiling rod holder

ADD-A-SHOWER RISER BRACKETS

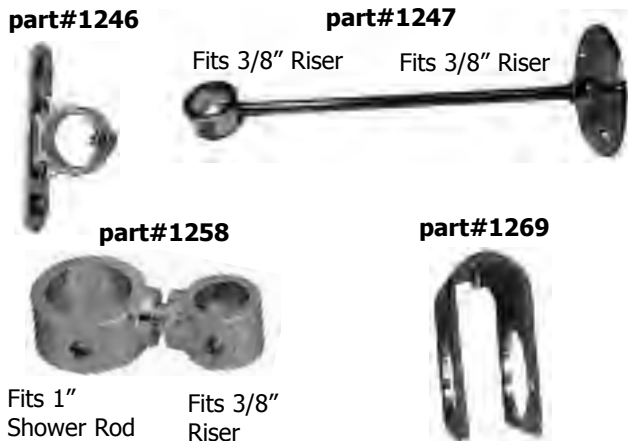

PART#	DESCRIPTION
1246	Fixed wall brackets for risers
1247	Bracket for risers
1258	Rod to riser coupling
1269	Rod coupling loop for part#1264 & part#1265

Add - A - SHOWER

Add - A - SHOWER OVER THE RIM



- Chrome plated die cast spout 1/2" IPS

PART#	d ESCRIPTION
2825	Over the rim supplied as shown
2831	Spout ONLY

Add - A - SHOWER REGUI AR STYl E



- Chrome plated brass bathcock
- Specifically for CLAWFOOT

PART#	d ESCRIPTION
2826	Regular style bathcock 3-3/8" centers supplied as shown
2832	Bathcock ONLY
Replacement parts	
1247	Wall bracket with rod
2836-3	3/8" x 60" CP brass riser
1189CSA	Shower head
1258	Rod-to-riser adapter
2837C	Cold stem
2837H	Hot stem
2838	Bathcock seats (pair)
2839	Hot & cold handle set











BATHCOck (ONI y)



- Supplied with adapter (**part#2830**) to connect shower hose
- Lever handles
- 3/4" male connections
- Chrome plated brass - 3-3/8" centers
- 3/8" riser connection
- cUPC approved

PART#	d ESCRIPTION
2832	Bathcock (only) for Add - A - Shower
2830	Adapter only for shower hose

BRASS & ABS SHOWER dRAINS

<p>BRASS SHOWER dRAIN QUICK SET</p>   <ul style="list-style-type: none"> - Use with Gelcoat & Acrylic shower stalls - Internal locknut & gasket for 2" DWV - Chrome plated brass strainer - Brass body & locknut - cUPC approved 		<p>ABS QUICK CAULK SHOWER</p>  <ul style="list-style-type: none"> - Use with Gelcoat & Acrylic shower stalls - Internal locknut & gasket for 2" DWV - Chrome plated strainer - ABS body & locknut - cUPC approved 	
<p>PART# d DESCRIPTION</p> <p>7980 Brass shower drain quick set 2"</p>	<p>PART# d DESCRIPTION</p> <p>8018 ABS quick caulk shower drain 2"</p>		
<p>2" PULL TIGHT SHOWER dRAIN COMPRESSION ABS</p>   <ul style="list-style-type: none"> - Unique pull tight design allows installation to be done from the top - Fits most 2" pipe installations - Being able to install with one person and tighten from inside shower stall saves time and money spent on labour 		<p>CLAMPING STYLE ABS SHOWER dRAIN</p>   <ul style="list-style-type: none"> - Comparable to "BABY BLUE" - Stainless steel grid - Fits 2" or 1-1/2" drains - cUPC approved 	
<p>PART# d DESCRIPTION</p> <p>8033 2" pull tight shower drain</p>	<p>PART# d DESCRIPTION</p> <p>8014 Clamping style ABS shower drain</p>		
<p>CLAMPING STYLE ABS SHOWER dRAIN SQUARE</p>   <ul style="list-style-type: none"> - Comparable to "BABY BLUE" - Stainless steel grid - Fits 2" or 1-1/2" drains - cUPC approved 		<p>SQUARE GRID FOR CLAMPING STYLE SHOWER dRAIN BRUSHED NICKEL</p>  <ul style="list-style-type: none"> - Square top cover shower drain in brushed nickel - Fits part#8013 or part#8014 	
<p>PART# d DESCRIPTION</p> <p>8013 Clamping style ABS shower drain</p>	<p>PART# d DESCRIPTION</p> <p>8015BN Square grid brushed nickel</p>		

TUB AND SHOWER

ABS OFFSET SOLVENT WELD DRAIN



- Use with Gelcoat & Acrylic shower stalls
- Internal locknut & gasket for 2" DWV
- Chrome plated strainer
- ABS body

ABS 2 PIECE SOLVENT WELD DRAIN



- Use with Gelcoat & Acrylic shower stalls
- Chrome plated strainer
- ABS body
- cUPC approved

PART#	DESCRIPTION
8032	ABS offset solvent weld drain

PART#	DESCRIPTION
8017	ABS 2 piece drain

ABS 2 PIECE SOLVENT WELD DRAIN



- Use with Gelcoat & Acrylic shower stalls
- White strainer
- ABS body
- cUPC approved

CLAMPING STYLE ABS SHOWER



- Wide body flange
- Fits 2" drains
- Stainless steel grid
- cUPC approved

PART#	DESCRIPTION
8019	ABS 2 piece drain

PART#	DESCRIPTION
8031	Clamping style ABS shower

TUB AND SHOWER

E

FLOOD GUARDS, BRASS



- LYNCAR brass flood guards.
- Available in either 3" or 4" sizes, brass body, rubber outer
- Boxed packaged

UTILITY DRAIN



- Brass utility drain
- 2" size

PART#	DESCRIPTION	PART#	IPS	MATERIAL
11400	3"	1171	2"	Brass
11405	4"			

STRAINER - REPLACEMENT



- Snap-in stainless steel

ABS SOLVENT WELD DRAINS



- Solvent weld drains
- Stainless steel or one piece PVC grid
- Fits inside pipe
- Use to cover any open-end-pipe

PART#	STRAINER SIZE	FITS	PART#	TYPE	FITS
1205	3"	2" DWV	8020	ABS grids	2" DWV
1206	4"	3" DWV	8021	ABS grids	3" DWV
1207	5"	4" DWV	8022	Stainless steel grids	3" DWV
			8023	Stainless steel grids	4" DWV

OVERFLOW STRAINER



- For claw foot or roll rim tubs
- 3" diameter

STRAINER - TUB THREE PRONG



- Stainless steel

PART#	DESCRIPTION	PART#	DESCRIPTION
1357	Overflow strainer CP brass	1342	1-7/8"
		1343	1-5/8"

TUB & SHOWER

SHOWER PAN LINER

SHOWER PAN LINER



- ASTM approved D4551
- PVC shower pan liner by LYNCAR
- LYNCAR is a leader in shower pan development
- Shower pan liner has been available since 1964 as a waterproofing alternative to the expensive hot mop, or lead sheet lining methods
- LYNCAR'S shower pan is used in shower stalls, gang showers, steam rooms, roman tubs, fountains, ornamental or reflecting pools, & other concealed waterproofing applications
- LYNCAR'S shower pan liner meets ASTM specifications, & is manufactured from 100% virgin poly vinyl chloride resin
- NO regrind or recycled materials are used in manufacturing this product
- Our shower pan liner is unaffected by concrete or cement, however should not be installed where it is exposed to direct sunlight
- LYNCAR'S shower pan liner is clearly marked with our LYNCAR part number, sheet size & the product is ruled every 6" for ease of measurement
- A full & detailed "How to install shower pan liners" is available at www.lyncar.com
- cUPC approved



PART#	WID TH	LENG TH	COI OUR	MI I	SQ/FT PER ROI I
3015	4 ft	50 ft	Black	30	200
3017	5 ft	40 ft	Black	30	200
3019	6 ft	50 ft	Black	30	300

PART#	d ESCRIPTION
3008	Shower Pan Cement 16 oz BT/can

LYNCAR TRUEGRIP STAINLESS STEEL GRAB BARS

E

GRAB BAR - STRAIGHT



- Professional quality
- 1-1/4" & 1-1/2" diameters
- Welded construction
- Concealed flange
- Polished stainless steel
- Knurled
- Boxed package

PART#	TYPE	LENGTH
5571412	1-1/4" diameter	12"
5571418	1-1/4" diameter	18"
5571424	1-1/4" diameter	24"
5571436	1-1/4" diameter	36"
5571212	1-1/2" diameter	12"
5571218	1-1/2" diameter	18"
5571224	1-1/2" diameter	24"
5571236	1-1/2" diameter	36"

GRAB BAR - "L" SHAPED



- 1-1/4" diameter grab bar
- Chrome plated finish
- 24" x 24" size
- Knurled
- 1 per box

PART#	TYPE	DESCRIPTION
557321	1-1/4" diameter	24 x 24" left chrome
557322	1-1/4" diameter	24 x 24" right chrome

GRAB BAR - 90°



- Left or right mounting
- Professional quality
- Welded construction
- Concealed flange
- Polished stainless steel
- Knurled
- Boxed package

PART#	TYPE	DESCRIPTION
557230	1-1/4" diameter	16 x 24" left hand
557231	1-1/4" diameter	16 x 24" right hand

TUB & SHOWER

TUB AND SHOWER

gRAB BAR 45°



- Left or right mounting
- Professional quality
- Welded construction
- Concealed flange
- Polished stainless steel
- Knurled
- Boxed package

PART#	TYPE	DESCRIPTION
557232	1-1/4" diameter	33 x 27" left hand
557233	1-1/4" diameter	33 x 27" right hand

BATHTUB ANgI Ed gRAB BAR 45°



- Small angled grab bar
- Professional quality
- Welded construction
- 2 concealed flanges of 1" diameter 45°
- Knurled

PART#	DESCRIPTION
557218	9" x 9" x 1" diameter

BATHTUB ANgI Ed gRAB BAR 80°



- Small angled grab bar
- Professional quality
- Welded construction
- 2 concealed flanges 1" diameter 80°
- Knurled

PART#	DESCRIPTION
557418	9" x 9" x 1-1/4" diameter

TUB AND SHOWER

TOWEL SHELF & RACK



- Commercial towel bar and top shelf
- 24" wide x 10" deep, with mounting hardware
- Chrome or brushed nickel finishes

TOWEL BARS



- LYNCAR'S towel bars & accessories offer a low cost series of products for the rental, maintenance & home owner
- You can stock the complete towel bar or its components depending on your needs
- All of LYNCAR'S towel bars are chrome plated zinc material, 3/4" bars

PART#	DESCRIPTION	PART#	DESCRIPTION	BRACKETS ONLY
557101	Chrome plated	4518	18" Complete unit	
557101BN	Brushed nickel	4518B	18" Bar only	
		4524	24" Complete unit	
		4524B	24" Bar only	4518BR
		4526	30" Complete unit	(Fits all size bars)
		4526B	30" Bar only	
		4527	36" Complete unit	
		4527B	36" Bar only	

TOILET PAPER HOLDER



- LYNCAR'S toilet paper holder are zinc chrome plated
- Sold as complete unit
- Also available replacement inserts sold bulk in bags of 100, white plastic

TOOTHBRUSH & GLASS HOLDER



- LYNCAR'S glass & toothbrush holder
- Chrome plated zinc

PART#	DESCRIPTION	PART#	DESCRIPTION
4519	Toilet paper holder complete	4520	Toothbrush & glass holder
4522	Replacement roller 3/8, 5/8 white plastic		

E

NOTES

TUB & SHOWER

BRAIDED SUPPLIES

BRAIDED SUPPLY - TOILET



- Stainless steel #304 braided supply
- PVC inner hose (CSA approved)
- Plated brass nuts
- 100% pressure tested
- Logo and lot stamps
- Won't kink or crease
- Meets CSA B125.3 and ASSE A112.18.6 standards
- NSF 61 and cUPC approved



PART#	DESCRIPTION
55513	7/8" ballcock nut x 3/8" OD comp. x 9"
55510	7/8" ballcock nut x 3/8" OD comp. x 12"
55511	7/8" ballcock nut x 3/8" OD comp. x 16"
55512	7/8" ballcock nut x 3/8" OD comp. x 20"

BRAIDED SUPPLY - FAUCET



- Stainless steel #304 braided supply
- PVC inner hose (CSA approved)
- Plated brass nuts
- 100% pressure tested
- Logo and lot stamps
- Won't kink or crease
- Meets CSA B125.3 and ASSE A112.18.6 standards
- NSF 61 and cUPC approved



PART#	DESCRIPTION
55503	1/2" IPS x 3/8" OD comp. x 9"
55500	1/2" IPS x 3/8" OD comp. x 12"
55501	1/2" IPS x 3/8" OD comp. x 16"
55502	1/2" IPS x 3/8" OD comp. x 20"
55504	1/2" IPS x 3/8" OD comp. x 30"

BRAIDED SUPPLY - ICE MAKER



- Stainless steel #304 braided supply
- PVC inner hose (CSA approved)
- Plated brass nuts
- 100% pressure tested
- Logo and lot stamps
- Braided stainless steel
- Won't kink or crease
- Meets CSA B125.3 and ASSE A112.18.6 standards
- NSF 61 and cUPC approved



PART#	DESCRIPTION
55530	1/4" OD comp. x 1/4" OD comp. x 12"
55532	1/4" OD comp. x 1/4" OD comp. x 36"
55534	1/4" OD comp. x 1/4" OD comp. x 48"
55536	1/4" OD comp. x 1/4" OD comp. x 60"
55538	1/4" OD comp. x 1/4" OD comp. x 72"

BRAIDED SUPPLIES

BRAIDED SUPPLY - WASHING MACHINE, STANDARD



- Stainless steel #304 braided supply
- PVC inner hose
- 100% tested
- Standard flow
- 1/4" I.D tube
- Logo & lot stamped
- Won't kink or crease
- Meets CSA B125.3
- cUPVC approved

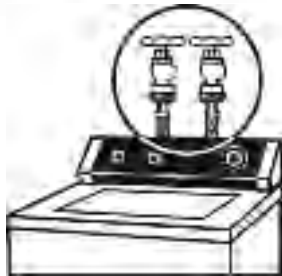

PART#	DESCRIPTION
55520	3/4" x 3/4" FGHT x 48"
55522	3/4" x 3/4" FGHT x 60"
55524	3/4" x 3/4" FGHT x 72"
55526	3/4" x 3/4" FGHT x 144"

BRAIDED SUPPLY - DISHWASHER



New style
part# 2155



Elbow with PEX fitting
part# 2159



Old style
part# 2161



- Stainless steel #304 braided supply
- PVC inner hose (CSA approved)
- Plated brass nuts
- 100% pressure tested
- Logo and lot stamps
- Won't Kink or crease
- Meets CSA B125.3 and ASSE A112.18.6 standards
- NSF 61 and cUPC approved

PART#	DESCRIPTION
55507	3/8" OD comp. x 3/8" OD comp. x 12"
55509	3/8" OD comp. x 3/8" OD comp. x 20"
55514	3/8" OD comp. x 3/8" OD comp. x 48" with 90° elbow
55516	3/8" OD comp. x 3/8" OD comp. x 60" with 90° elbow
55518	3/8" OD comp. x 3/8" OD comp. x 72" with 90° elbow
555141	3/8" OD comp. x 3/8" OD comp. x 48" with FHT/elbow
555161	3/8" OD comp. x 3/8" OD comp. x 60" with FHT/elbow
555181	3/8" OD comp. x 3/8" OD comp. x 72" with FHT/elbow
2155	Elbow 3/4" FHT x 3/8" MIP (available separately)
2159	Adaptor fitting 3/4" FHT x PEX brass elbow
2161	Connection fitting, 38 MIP x 3/8 comp. 90



BRAIDED SUPPLIES

BRAIDED SUPPLY - WASHING MACHINE, 90° ELBOW, PREMIUM



- Premium, oversized hose increased flow rates
- 90° elbow connect 3/4" FGHT
- Stainless steel #304 braided supply
- PVC inner hose
- 100% tested
- 3/8" I.D tube
- Logo & lot stamped
- Won't kink or crease
- Meets CSA B125.3
- NSF and cUPC approved



PART#	DESCRIPTION
55598	60" long
55599	72" long

BRAIDED SUPPLIES FOR FAUCET (COUPLING S)



- 1/2" IPS x 1/2" IPS
- Stainless steel #304 braided supply
- PVC inner hose (CSA approved)
- Plated brass nuts
- 100% pressure tested
- Logo and lot stamps
- Won't kink or crease
- Meets CSA B125.3 and ASSE A112.18.6 standards
- NSF 61 and cUPC approved



PART#	DESCRIPTION
55596	9" coupling connector
55597	12" coupling connector

BRAIDED SUPPLIES FOR FAUCET



- Used on builder series faucets
- Stainless steel #304 braided supply
- PVC inner hose (CSA approved)
- Plated brass nuts
- 100% pressure tested
- Logo and lot stamps
- Meets CSA B125.3 and ASSE A112.18.6 standards
- NSF 61 and cUPC approved



PART#	DESCRIPTION
55506	3/8" comp x 3/8" female comp x 12"
55508	3/8" comp x 3/8" female comp x 20"

BRAIDED SUPPLY - HOT WATER HEATER



- Meets CSA B125 standard
- Santoprene tube
- Stainless steel #304 braided supply
- NSF and cUPC approved



PART#	DESCRIPTION
55585	3/4" FIP x 3/4" FIP x 12" long
55586	3/4" FIP x 3/4" FIP x 18" long
55587	3/4" FIP x 3/4" FIP x 24" long

BRAIDED SUPPLIES - FLUIDMASTER

DISHWASHER STAINLESS STEEL SUPPLY



- FLUIDMASTER brand
- Sleeve or bulk
- No-burst
- CSA approved

PART# DESCRIPTION

FM480	48" bulk
FM481	48" sleeve
FM460	60" bulk
FM461	60" sleeve
FM720	72" bulk
FM721	72" sleeve

ICE MAKER STAINLESS STEEL SUPPLY



- FLUIDMASTER brand
- Sleeve packaged
- No-burst
- CSA approved

PART# DESCRIPTION

FM260	60" sleeve
FM272	72" sleeve
FM2120	120" sleeve

WASHING MACHINE S.S. SUPPLY



- FLUIDMASTER brand
- Bulk packaged
- No-burst
- CSA approved

PART# DESCRIPTION

FM360	60" bulk
--------------	----------

KITCHEN & LAUNDRY

LAVATORY COUPLING NUT



PART#	SIZE	MATERIAL
1322	1/2" x 7/16"	Brass
1322C	1/2" x 7/16"	CP brass
1326C	1/2" x 3/8"	CP die cast
1327C	1/2" x 7/16"	CP die cast
1327P	1/2" x 7/16"	Die cast
1328C	1/2" x 1/2"	CP die cast
1328P	1/2" x 1/2"	Die cast
1335	1/2" x 1/2"	Brass
1335C	1/2" x 1/2"	CP brass

PLASTIC SUPPLY TUBES

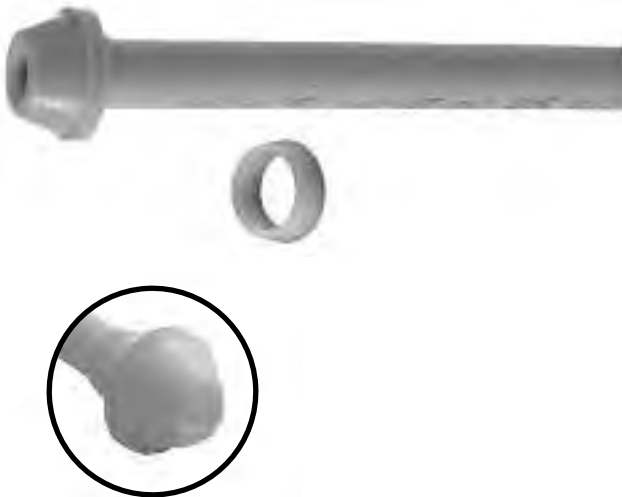

- PEX flexible supply tubes in 3/8" O.D. for faucets & toilet fill valves
- Pack 10 per bag
- With plastic ferrule

PART#	LENGTH	DESCRIPTION
55590	12"	For fill valve
55591	20"	For fill valve
55592	30"	For fill valve
55593	12"	For faucet valve
55594	20"	For faucet valve
55595	30"	For faucet valve

LAVATORY TAILPIECE



- 1/4" IPS x 1-1/2" long brass
- Sold per pair

PART#	DESCRIPTION
857	Lavatory tailpiece

INSTALLATION KITS

WATER CLOSET INSTALLATION KITS



Each package contains 1 of:
part#82 (Brass closet bolts 5/16" x 2-1/4")
part#55510 (12" toilet SS braided supply)

part#27082 includes **part#268** (wax gasket)
part#27083 includes **part#270** (wax gasket with horn)

PART#	DESCRIPTION
27082	Toilet installation kit
27083	Toilet installation kit, with wax gasket with horn

1/4 TURN STRAIGHT STOPS FAUCET HOOK UP KITS



Each package contains 2 of:
 1/4 turn straight stops
 Stainless steel braided supplies
part#1230 (1/2" flanges)

PART#	SUPPLY LENGTH	1/4 STRAIGHT STOPS
27085	12"	1/2" comp x 3/8" comp
27090	12"	1/2" sweat x 3/8" comp
27094	12"	1/2" PEX x 3/8" comp
27087	20"	1/2" comp x 3/8" comp
27091	20"	1/2" sweat x 3/8" comp
27095	20"	1/2" PEX x 3/8" comp

1/4 TURN ANGLE STOPS FAUCET HOOK UP KITS



Each package contains 2 of:
 1/4 turn angle stops
 Stainless steel braided supplies
part#1230 (1/2" flanges)

PART#	SUPPLY LENGTH	1/4 TURN ANGLE
27084	12"	1/2" comp x 3/8" comp
27092	12"	1/2" Sweat x 3/8 comp
27096	12"	1/2" PEX x 3/8 comp
27086	20"	1/2" comp x 3/8 comp
27093	20"	1/2" Sweat x 3/8 comp
27097	20"	1/2" PEX x 3/8 comp

DISHWASHER HOOK-UP KIT



Each package contains 1 of:
part#506065 teflon tape
part#3332 1/4 turn straight stop 1/2" compression x 3/8" compression
part#55516 60" stainless steel braided supply
part#27088 ABS fitting dw wye
 1-1/2" x 1-1/2" x 3/4" barb

PART#	DESCRIPTION
27089	Dishwasher hook up kit

3 WAY QUARTER TURN vALvES

QUARTER TURN vALvE WITH TEE FITTING



- Quarter turn valve
- With tee fitting
- Chrome plated
- 3/8" or 1/4" connected
- 1 per bag
- cUPC approved valve

PART#	DESCRIPTION
3406	3/8" O.D. x 3/8" female O.D. x 3/8" O.D.
3407	3/8" O.D. x 3/8" female O.D. x 1/4" O.D.

QUARTER TURN 3 WAY vALvE



- 3 way valve
- Chrome plated
- Quarter turn
- Brass plug included
- 1 per bag
- cUPC approved

PART#	DESCRIPTION
3404	5/8" O.D. x 3/8" O.D. x 1/4" O.D.
3405	3/8" O.D. x 3/8" O.D. x 1/4" O.D.

QUARTER TURN vALvE PEX TEE FITTING



- Quarter turn valve
- Chrome plated fitting
- Use on dishwasher
- Use on humidifier
- 1 per bag
- cUPC approved valve

PART#	DESCRIPTION
3410	1/2" PEX x 1/2" PEX x 3/8" O.D. comp.
3411	1/2" PEX x 1/2" PEX x 1/4" O.D. comp.

ADAPTER TEE - 3 WAY



- Brass adapter valve
- Retrofit applications
- 1 per bag

PART#	DESCRIPTION
3415	3/8" female O.D. comp. x 3/8" comp. x 1/4" comp.
3416	3/8" female O.D. comp. x 3/8" comp. x 3/8" comp.

STOP vALvES

**QUARTER TURN STOP
ANgLE 1/2" COPPER SWEAT**



- Chrome plated
- Smooth 1/4 turn on/off action
- Brass ball & body
- PTFE seats
- Premium quality
- NSF 61.9 approval
- cUPC approved

**QUARTER TURN STOP
ANgLE 3/8" FIP**



- Chrome plated
- Smooth 1/4 turn on/off action
- Brass ball & body
- PTFE seats
- Premium quality
- NSF 61.9 approval
- cUPC approved

PART#	DESCRIPTION
3334	1/2" copper sweat x 3/8" compression

PART#	DESCRIPTION
3333	3/8" FIP x 3/8" compression

**STOP vALvES ANgLE, COMPRESSION
1/2" SWEAT**



- Chrome plated
- Solid die cast plated handle
- Brass body
- Plated brass stem
- Premium quality
- cUPC approved

**STOP vALvES, COMPRESSION
ANgLE 3/8" FIP**



- Chrome plated
- Solid die cast plated handle
- Brass body
- Plated brass stem
- Premium quality
- cUPC approved

PART#	DESCRIPTION
12655	1/2" Sweat x 3/8" compression

PART#	DESCRIPTION
12651	3/8" FIP x 3/8" compression

STOP vALvES

**QUARTER TURN STOP STRAIgHT
3/8" F.I.P. INLET**



- Chrome plated
- Smooth 1/4 turn on/off action
- Brass ball & body
- PTFE seats
- Premium quality
- NSF 61.9 approval
- cUPC approved

**QUARTER TURN STOP STRAIgHT
1/2" COPPER SWEAT**



- Chrome plated
- Smooth 1/4 turn on/off action
- Brass ball & body
- PTFE seats
- Premium quality
- NSF 61.9 approval
- cUPC approved

PART#	DESCRIPTION
3329	3/8" F.I.P. inlet x 3/8" compression

PART#	DESCRIPTION
3331	1/2" copper sweat x 3/8" compression

**STOP vALvES, COMPRESSION
STRAIgHT 3/8" FIP**



- Chrome plated
- Solid die cast plated handle
- Brass body
- Plated brass stem
- Premium quality
- cUPC approved

**STOP vALvES STRAIgHT
1/2" SWEAT COMPRESSION**



- Brilliant chrome finish
- Solid die cast plated handle
- Brass body
- Plated brass stem
- Premium quality
- cUPC approved

PART#	DESCRIPTION
12650	3/8" FIP x 3/8" compression

PART#	DESCRIPTION
12654	1/2" sweat x 3/8" compression

STOP vALvES

**QUARTER TURN STOP
ANgLE 1/2" F.I.P. INLET**



- Chrome plated
- Smooth 1/4 turn on/off action
- Brass ball & body
- PTFE seats
- Premium quality
- NSF 61.9 approval
- cUPC approved

**QUARTER TURN STOP
STRAIghT 1/2" F.I.P. INLET**



- Chrome plated
- Smooth 1/4 turn on/off action
- Brass ball & body
- PTFE seats
- Premium quality
- NSF 61.9 approval
- cUPC approved

PART#	DESCRIPTION
3335	1/2" F.I.P. inlet x 3/8" compression

PART#	DESCRIPTION
3330	1/2" F.I.P. Inlet x 3/8" compression

**STOP vALvES ANgLE
1/2" FIP x COMPRESSION**



- Chrome plated
- Solid die cast plated handle
- Brass body
- Plated brass stem
- Premium quality
- cUPC approved

**STOP vALvES STRAIghT
1/2" FIP x COMPRESSION**



- Chrome plated
- Solid die cast plated handle
- Brass body
- Plated brass stem
- Premium quality
- cUPC approved

PART#	DESCRIPTION
12653	1/2" FIP x 3/8" compression

PART#	DESCRIPTION
12652	1/2" FIP x 3/8" compression

STOP vALvES

QUARTER TURN STOP ANgLE 5/8" OD COMPRESSION



- Chrome plated
- Smooth 1/4 turn on/off action
- Brass ball & body
- PTFE seats
- Premium quality
- NSF 61.9 approval
- cUPC approved

QUARTER TURN STOP STRAIgHT 5/8" COMPRESSION



- Chrome plated
- Smooth 1/4 turn on/off action
- Brass ball & body
- PTFE seats
- Premium quality
- NSF 61.9 approval
- cUPC approved

PART#	DESCRIPTION	PART#	DESCRIPTION
3336	5/8" compression x 3/8" compression	3332	5/8" compression x 3/8" compression

STOP vALvES ANgLE 5/8" COMPRESSION



- Chrome plated
- Solid die cast plated handle
- Brass body
- Plated brass stem
- Premium quality
- cUPC approved

STOP vALvES STRAIgHT 5/8" COMPRESSION



- Chrome plated
- Solid die cast plated handle
- Brass body
- Plated brass stem
- Premium quality
- cUPC approved

PART#	DESCRIPTION	PART#	DESCRIPTION
12657	5/8" compression x 3/8" compression	12656	5/8" compression x 3/8" compression

STOP vALvES

ADD A STOP RETROFIT 1/4 TURN vALvE - STRAIgHT



- 1/4" turn smooth on/off
- Don't spend time removing an existing stop or fitting, especially in tight places
- It only takes seconds to thread the 1/4 turn retrofit ball stop onto an existing fitting or seized stop
- Premium quality
- cUPC approved

ADD A STOP RETROFIT 1/4 TURN vALvE - ANgLE



- 1/4" turn smooth on/off
- Don't spend time removing an existing stop or fitting, especially in tight places
- It only takes seconds to thread the 1/4 turn retrofit ball stop onto an existing fitting or seized stop
- Premium quality
- cUPC approved

PART#	DESCRIPTION
3326	3/8" compression x 3/8" compression

PART#	DESCRIPTION
3325	3/8" compression x 3/8" compression

QUARTER TURN STOP ANgLE, WITH 1/4" MALE THREAD



- 1/4 turn on/off valves
- Brass ball & body
- Forged quarter turn angle stops with 1/4" MPT connection
- Premium quality
- cUPC approved

QUARTER TURN STOP STRAIgHT WITH 1/4" MALE THREAD



- 1/4 turn on/off valves
- Brass ball & body
- Forged quarter turn angle stops with 1/4" MPT connection
- Premium quality
- cUPC approved

PART#	DESCRIPTION
3560	1/4" MPT x 3/8" compression

PART#	DESCRIPTION
3562	1/4" MPT x 3/8" compression

AERATORS

AERATOR PREMIUM QUALITY



PART#	THREADS	STYLE	g PM @ 60 PSI
2100	Male 15/16" -27	Slotted	2.0
2103	Female 55/64" -27	Slotted	2.0
2105	Dual 15/16" - 55/64" -27	Slotted	2.0
2105BN	Dual 15/16" - 55/64" - 27	Slotted brushed nickel	2.0
2105PB	Dual 15/16" - 55/64" - 27	Slotted polished brass	2.0
2104	Dual 15/16" - 55/64"- 27	Slotted WS	1.5

AERATOR ECONOMY QUALITY



PART#	THREADS	STYLE	g PM @ 60 PSI
2120	Male 15/16" -27	Non-slotted	2.0
2122	Female 55/64" -27	Non-slotted	2.0
2124	Dual 15/16" -55/64" -27	Non-slotted	2.0
2130	Male 13/16" -27	Non-slotted	2.0
2131	Female 13/16" -27	Non-slotted	2.0
2132	Male 15/16" -27	Non-slotted WS	1.5
2133	Female 55/64" -27	Non-slotted WS	1.5
2134	Dual 15/16" -55/64" -27	Non-slotted WS	1.5
2135	Female 55/64" -27	Non-slotted WS	1
2137	Dual 15/16" -55/64" -27	Non-slotted WS	1
2138	Male 15/16" -27	Non-slotted WS	1

AERATOR - 6 PACK TUBES



PART#	TYPE	STYLE	g PM @ 60 PSI
2103T	Premium - female 55/64" -27	Slotted	2.0
2105T	Premium - dual 15/16"-55/64" - 27	Slotted	2.0
2104T	Premium - dual 15/16"-55/64" - 27	Slotted WS	1.5
2120T	Economy - male 15/16" - 27	Non-slotted	2.0
2122T	Economy - female 55/64" - 27	Non-slotted	2.0
2124T	Economy - dual 15/16"-55/64" - 27	Non-slotted	2.0
2130T	Economy - male 13/16" - 27	Non-slotted	2.0
2132T	Economy - male 15/16" -27	Non-slotted	1.5
2133T	Economy - female 55/64" - 27	Non-slotted WS	1.5
2134T	Economy - dual 15/16"-55/64" - 27	Non-slotted WS	1.5

AERATORS

AERATOR - COUNTER DISPLAYS

24
Tubes
6 Aerators
per tube



- These displays are guaranteed to trigger an impulse purchase by the plumber!
- Small display generates BIG profits!

Slotted premium quality

PART#	DUAL THREADS
2106	Contains 144 - part#2105
2107	Contains 144 - part#2104 (water saver)

Non-slotted economy quality

PART#	DUAL THREADS
2125	Contains 144 - part#2124
2136	Contains 144 - part#2134 (water saver)

AERATOR - vANDAL RESISTANT



- Chrome plated brass
- Special key wrench included

PART#	TYPE	FLOW	g PM @ 60PSI
2126	Female - 55/64" - 27T	Water saver	.50
21261	Female - 55/64" - 27T	Water saver	1.0
2127	Male - 15/16" - 27T	Water saver	.50
21271	Male - 15/16" - 27T	Water saver	1
2128	Female - 55/64" - 27T	Standard	2.2
2129	Male - 15/16" - 27T	Standard	2.2
2126K	Replacement key only		

AERATOR - SWIVEL



- Popular double jointed swivel aerators
- All white or white with chrome trim
- Counter display with 36 units

PART#	TYPE	DESCRIPTION
2002	Shower head - low flow	1.5 gpm, CSA approved
2002A	Single aerators - double	White with chrome trim
2002B	Single aerators - double	All White
2002D	Point of sale counter display	18 - 2002A & 18 - 2002B
2002DC	Point of sale counter display	36 - 2002A
2002vP	Shower head - low flow vandal proof	1.5 gpm, CSA approved

AERATORS & AERATOR ADAPTERS

PREMIUM DECORATIVE AERATOR , PYRAMID



- Pyramid style premium aerator
- Chrome finish
- 15/16 male thread
- 2.0 GPM
- Perfect match to classical & decorative faucets

PART#	DESCRIPTION
1995	Pyramid style aerator

PREMIUM DECORATIVE, BELL



- Bell style premium aerator
- Chrome finish
- 15/16 male thread
- 2.0 GPM
- Perfect match to classical & decorative faucets

PART#	DESCRIPTION
1996	Bell style aerator

PREMIUM DECORATIVE AERATOR , FLUTE



- Flute style aerator
- Chrome finish
- 15/16 male thread
- 2.0 GPM
- Perfect match to classical & decorative faucets

PART#	DESCRIPTION
1997	Flute style aerator

AERATOR ADAPTER, DUAL THREAD FAUCET TO HOSE THREAD



- Threadsize: 55/64-27, 1516-24 x 3/4GHT

PART#	DESCRIPTION
2260	Faucet to hose thread

AERATOR ADAPTER, W/ gARDEN HOSE THREAD

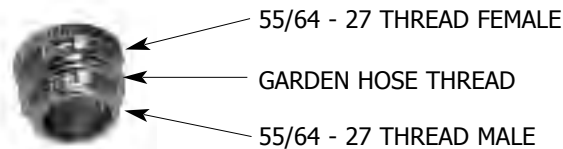

PART#	DESCRIPTION
2261	Garden hose thread

MALE ADAPTER, 15/16" - 27 TPI X 55/64" - 27 TPI



PART#	DESCRIPTION
2262	15/16" - 27 TPI x 55/64" - 27 TPI

KITCHEN & LAUNDRY

MALE ADAPTER, 13/16" - 27 TPI x 55/64" - 27 TPI



PART#	DESCRIPTION
2263	13/16" - 27 TPI x 55/64" - 27 TPI

FEMALE x MALE 55/64" - 27 TPI



PART#	DESCRIPTION
2264	Female 3/4" x male 55/64 x 27 TPI
2265	Female 13/16" x male 55/64 x 24 TPI

FEMALE 55/64" - 27 TPI x FEMALE 15/16" - 24 TPI



PART#	DESCRIPTION
2177	Chrome plated brass female 55/64" - 27 TPI x female 15/16" - 24 TPI

DISHWASHER ADAPTER



PART#	DESCRIPTION
2266	Dual thread dishwasher adapter w/aerator
2178	Female thread dishwasher adapter w/aerator
2180	Dual thread dishwasher adapter non-aerator

LAVATORY LEGS

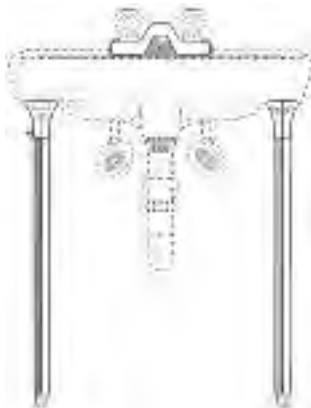

- Chrome plated
- 2" adjustment
- 30" overall length
- Boxed by the pair
- Installation instructions with each pair
- Adjustable to fit a variety of china & enamel lavatories

PART#	DESCRIPTION
1250	Lavatory legs

KITCHEN & LAUNDRY

F

DEEP BASIN ROSETTE



- Stamped steel

FLAT BASIN ROSETTE



- Stamped steel

PART#	DESCRIPTION
1266	Deep basin rosette

PART#	DESCRIPTION
1268	Flat basin rosette

FAUCET HOLE COVERS



- Covers pre drilled holes on sink and counters

NUT - LOCK



- Sink strainer replacement nut in brass

PART#	SIZE
1274	2"
1275	1-3/4"

PART#	SIZE	MATERIAL
1312	3-3/8"	Brass basket strainer

SNAP-IN FAUCET HOLE COVER



- Chrome plated
- Fits 1-1/2" hole
- Holes in china or stainless steel fixtures vary in diameter
- This cover fits most but not all manufacturers

SINK HOLD DOWN BOLT



- Hold down sinks
- Pack of 4 or bulk available
- 3-5/16" long x 1/4" diameter
- With side clip

PART#	DESCRIPTION
1279	Snap-in faucet hole cover

PART#	DESCRIPTION
4517	Sink hold down bolt - 4 pack
4517Q	Sink hold down bolt - bulk

KITCHEN & LAUNDRY

KITCHEN & LAUNDRY

STOPPER - FIT ALL RUBBER



PART#	BULK PART#	DESCRIPTION
12000	12000Q	Basin 1" to 1-3/8"
12001	12001Q	Tub 1-1/2" to 2"

RUBBER STOPPER



PART#	BULK PART#	SIZE
12005	12005Q	1"
12006	12006Q	1-1/8"
12007	12007Q	1-1/4"
12008	12008Q	1-3/8"
12009	12009Q	1-1/2"
12010	12010Q	1-5/8"
12011	12011Q	1-3/4"
12012	12012Q	1-7/8"

BEAD CHAIN # 10



PART#	MATERIAL	DESCRIPTION
1122	Plated steel	250 ft. roll
1124	Plated brass	250 ft. roll
1130	Plated steel	Connector type "B"
1131	Plated steel	Connector type "A"

BATH & BASIN STOPPER CHAIN

- "B" Connector with loop ring
- Stoppers not included



PART#	MATERIAL	DESCRIPTION
1123	Plated steel	11" - basin w/ "B" connector
1123A	Plated steel	11" - basin w/ "B" connector & loop ring
1125	Plated steel	15" - bath w/ "B" connector
1125A	Plated steel	15" - bath w/ "B" connector & loop ring
1118	Plated brass	11" - basin w/ "B" connector
1118A	Plated brass	11" - basin w/ "B" connector & loop ring
1119	Plated brass	15" - bath w/ "B" connector
1119A	Plated brass	15" - bath w/ "B" connector & loop ring

KITCHEN & LAUNDRY

F

SINK STRAINER, WIRE MESH



- Chrome plated wire mesh screens
- Contains 3 strainers, 2", 2 3/4" and 3 1/2" wide
- For use in sinks & bathtubs
- Allows water to drain while catching debris, food, hair etc.
- Displayed packaged

SINK STRAINER, PLASTIC



- White plastic screens for sink and bath
- Contains 2" and 2-3/4" sizes
- Allows water to drain while catching debris, food, hair etc.
- Display packaged

PART#	DESCRIPTION
21822	Wire mesh, 3 piece set

PART#	DESCRIPTION
21820	Plastic strainers, large and small

HAIR SNARE



- LYNCAR'S hair snare
- White PVC
- Packaged for display
- Use in household drains

HOSE CLAMP



- All stainless steel hose clamp
- Stainless housing and screw
- 10 pieces per box
- For full line of LYNCAR'S hose clamps see **page J-5**

PART#	DESCRIPTION
21817	Hair snare

PART#	DESCRIPTION
63010	5/8" clamp
63016	7/8" clamp

DISHWASHER DRAIN HOSE



- Box packaged
- Made of braided rubber with a rayon tire grade cord
- It is an extremely durable hose & resists kinking

DISHWASHER CONNECTOR KIT



- Rigid construction
- Will not collapse

PART#	SIZE	LENGTH
506	5/8"	50'
507	7/8"	50'

PART#	DESCRIPTION
496	Dishwasher connector kit

KITCHEN & LAUNDRY

DUCTING

FRESH AIR INTAKES W/ SCREEN



- To allow fresh air to enter the home
- 1/4" galvanized screen included.
- For fireplaces, H.E. furnaces



PART#	DESCRIPTION
1716W	3" new style - white
1716B	3" new style - brown
1717W	4" new style - white
1717B	4" new style - brown

DRYER vENT KIT - PRO FLEX



- With 4" x 8' aluminum duct pipe, wall flange & clamps
- UL listed recommended for gas & electric dryers



PART#	DESCRIPTION
1716	Dryer vent kit - pro flex

vENT CAPS REPLACEMENT



- Flat screen(louvered) or traditional



PART#	DESCRIPTION
1696W	4" traditional - white
1696B	4" traditional - brown
1697W	4" louvered - white
1697B	4" louvered - brown
1698W	4" fresh air (molded screen) - white
1698B	4" fresh air (molded screen) - brown

vENT HOOD- TRADITIONAL STYLE



- With 4" aluminum duct pipe
- Weather resistant
- Paintable
- Narrow profile
- Prevents drafts



PART#	COLOUR
1718W	White
1718B	Brown

vENT HOOD - LOUVERED STYLE



- With 4" aluminum duct pipe



PART#	DESCRIPTION
1721W	White
1721B	Brown

DUCTING

DUCT - PRO FLEX DRYER TRANSITION



- Box packaged
- 4" diameter x 8 feet long
- UL approved, listed & marked

PART#	DESCRIPTION
1714	Duct - PRO FLEX Dryer transition

DUCT - FLEXIBLE ALUMINUM FOIL



- Box packaged
- 4" diameter x 25 feet long
- Recommended for venting electric dryer & air intake
- cUL listed

PART#	DESCRIPTION
1720	4" x 25' boxed

DUCT - FLEXIBLE ALUMINUM



- Box packaged
- 4" diameter x 10' long
- Recommended for venting gas dryer
- cUL listed

PART#	DESCRIPTION
1694	4" x 10' boxes

DUCT - RESIDENTIAL INSULATED



- 4" diameter x 25 feet long
- Bulk packaged
- Recommended for venting
- cUL, UL approved, listed & marked

PART#	DESCRIPTION
16955	4" x 25'

DUCTING

DRYER vENT KIT - INDOOR



- Used for electric dryers when outdoor venting is not possible
- Great for apartments and R.V's
- 1 per box & 12 per case
- cUL approved PROFLEX dryer duct included



PART# DESCRIPTION

1719 Dryer vent kit - indoor

CLAMPS FOR DRYER DUCTS



- Extra clamps for mounting dryer duct



PART# DESCRIPTION

1724 3"- 4" adjustable plastic clamp

1723 4" tension metal clamp

DRAIN COvER ALUMINUM



- Aluminum floor drain cover
- Heavy duty construction
- 1/4" thick x 4-1/2" diameter

PART# DESCRIPTION

1216 Drain cover replacement

WASHING MACHINE PAN



- High impact white polypropylene Plastic Matte finish
- Will not rust, corrode or crack
- Includes PVC drain fitting
- Bottom or side outlet (not pre-cut)
- 1" drain can pass all codes
- Easy to install
- OD 27" x 30" x 2-1/8"
- Only sold as boxes of 6

PART# DESCRIPTION

11506 Washing machine pan

LAUNDRY HOOKS - ALUMINUM



- Aluminum hooks for drain on laundry
- Available in 3/4" or 1" diameter sizes

PART# SIZE

12605 3/4" x 11"

12610 1" x 11"

MOLDED HOOK DRAIN HOSE



- Molded rubber drain hose
- With expanded end
- Will fit drain outlets of 3/4", 7/8" & 1" sizes

PART# DESCRIPTION

12600 Molded hook drain hose

FAUCET - BAR & LAUNDRY

FAUCET - LAUNDRY TRAY



- Laundry tray faucet, 4" centres
- Full metal construction, brass waterways
- Double O-Ring Spout
- Tubular spout with hose threads
- Metal chrome handles
- Trap seal primer
- Removeable aerator
- Compression cartridges



PART#	DESCRIPTION
-------	-------------

- | | |
|--------------|----------------------|
| 33200 | Faucet complete |
| 33201 | Handles - hot & cold |
| 33202 | Cartridge |

FAUCET - LAUNDRY BRASS



- All brass laundry tray faucet
- 4" centres
- 6" tubular spout with hose threads
- EMCO style red & blue laundry handles
- Mounting bracket included
- Trap seal primer
- Removeable aerator
- Compression cartridges
- CSA approved



PART#	DESCRIPTION
-------	-------------

- | | |
|--------------|-----------------|
| 33205 | Faucet complete |
| 2013 | Red handle |
| 2014 | Blue handle |
| 899 | Cartridge |

FAUCET - WALL MOUNT WITH SOAP DISH



- Chrome plated cast brass body
- 6" cast spout
- Complete with soap dish
- Lever handles
- Rear flanges

PART#	DESCRIPTION
-------	-------------

- | | |
|--------------|------------------------------------|
| 21815 | Faucet - wall mount with soap dish |
|--------------|------------------------------------|

BAR FAUCET



- Polished chrome plated metal
- 4" centres
- 6" goose neck spout
- Brass waterways
- Metal handles
- CSA approved



PART#	DESCRIPTION
-------	-------------

- | | |
|--------------|----------------------|
| 34295 | Faucet complete |
| 33201 | Handles - hot & cold |
| 33202 | Cartridge |

PANTRY FAUCETS

PANTRY FAUCET - LONG REACH

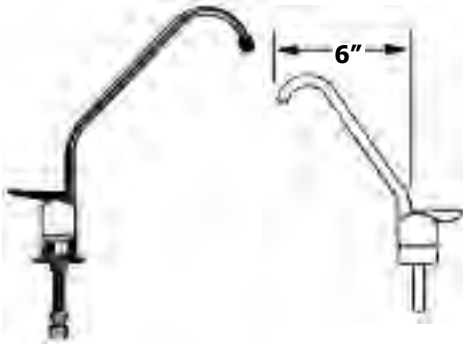

- 7/16" diameter hole required
- 1/4" compression connection
- Chrome
- cUPC approved

PART#	DESCRIPTION
2040LR	Pantry faucet - long reach

PANTRY FAUCET - TALL SPOUT

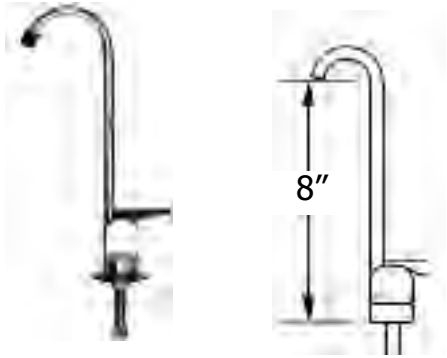

- 7/16" diameter hole required
- 1/4" compression connection
- Chrome

PART#	DESCRIPTION
2040TS	Pantry faucet - tall spout

PANTRY FAUCET - THE ORIGINAL

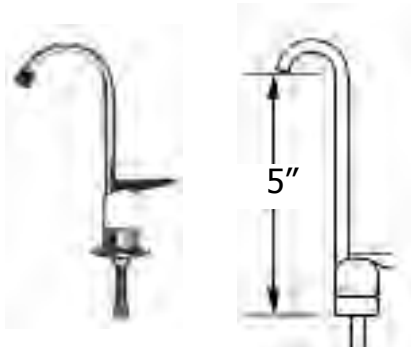

- 7/16" diameter hole required
- cUPC approved

PART#	FINISH	COMPRESSION CONNECTION
2040	Chrome	1/4"
2040BN	Brushed nickel	1/4"
2041	Chrome	3/8"

LIQUID SOAP DISPENSER UNIVERSAL QUALITY REPLACEMENT



- 2" spout
- 10" length
- Chrome plated or brushed nickel brass pump
- Mounts through counter
- Unbreakable poly bottle
- Holds 7 oz.

PART#	DESCRIPTION
2042	Chrome
2042BN	Brushed nickel
2042P	Replacement pump

KITCHEN & LAUNDRY

F

QUICK DECK PLATE

Retrofit Deck Repair Plate



Deck Repair Plate

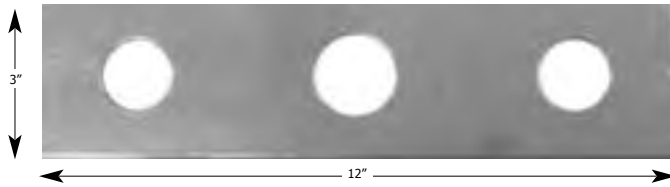

- 2 great time savers for the maintenance plumber 8" faucet deck repair plate
- This deck backer plate provides a solid foundation to secure 8" centre faucets.
- Ideal for securing faucets to counter tops with over size & irregular holes or uneven under-the counter mounting surfaces. 14GA
- Galvanized steel
- Select the retrofit deck repair plate for those situations when removing & reinstalling the supply lines are not practical
- Finish: galvanized steel painted red

PART#	DESCRIPTION
1214R	Retrofit repair plate
1214	Deck repair plate

FAUCET LOCKNUT



- Plastic 1/2 IPS
- For bottom thread on faucet

PART#	DESCRIPTION
4410	Faucet Locknut - pair
4410Q	Faucet Locknut - bulk

SHANK EXTENDERS



- Add additional threads to faucet to get below deep counters
- Answer to a common problem "I need more length to fit the granite top"
- 1-1/2" overall
- Seals with ID O-Rings
- Solid brass

PART#	DESCRIPTION
33216	Shank extenders, pair

KITCHEN & LAUNDRY

ICE MAKER HOOK-UP KITS

ICE MAKER KIT WITH POLY TUBING



For use on refrigerators with automatic icemakers. Also use on humidifiers.

KIT CONTAINS

- 1. 1/4" x 25' poly tubing
- 1. self-piercing needle valve
- 1. 1/4" compression union
- 2. 1/4" brass insert sleeves
- 2. 1/4" delrin insert sleeves

PART#	DESCRIPTION
2045	Poly hook - up kit

ICE MAKER KIT WITH COPPER TUBING



For use on refrigerators with automatic icemakers. Also use on humidifiers.

KIT CONTAINS

- 1. 1/4" x 25' copper tubing
- 1. self piercing needle valve
- 1. 1/4" compression union
- 1. 1/4" compression male
- 1. 1/4" 90° compression elbow

PART#	DESCRIPTION
2049	Copper hook up kit

ICEMAKER ACCESSORIES

SELF PIERCING NEEDLE VALVES



- For 3/8" To 1" copper tube
- KIT CONTAINS:
 Needle valve
 Saddle clamp
 Nuts
 Bolts

PART#	DESCRIPTION
2162	Self piercing needle valves
2162Q	Self piercing needle valves - bulk

VALVE - SELF-PIERCING SADDLE / HUMIDIFIER



- Easy to install
- Will not flatten pipe
- 1/4" compression outlet
- Fits 3/8", 7/16", 5/8" copper

PART#	DESCRIPTION
2165	Self piercing saddle valve
2165Q	Self piercing saddle valve - bulk

CARBON FILTER - GRANULATED



- Filters contain granulated carbon for taste & odor removal from municipal drinking water.
- Container - Polypropylene
- Media- activated carbon
- Filter/screen - Polyester Felt
- Micron size - 20
- Flow rate - 1 GPM @ 60 PSI
- Life span - 3-6 months
- Effective filtering - 2000 GAL.
- Temp rating - 120° F
- Pressure rating - 125 PSI

PART#	DESCRIPTION
2060	Carbon filter

FITTING ADAPTERS

COMPRESSION x COMPRESSION



- Chrome brass finish

PART#	TYPE	DESCRIPTION
12770	Straight body	3/8" compression x 5/8" compression
12771	Straight body	1/2" compression x 5/8" compression
12772	Angle body	3/8" compression x 5/8" compression
12773	Angle body	1/2" compression x 5/8" compression

SWEAT x COMPRESSION



- Brass finish

PART#	TYPE	DESCRIPTION
12777	Straight body	1/2" sweat x 3/8" compression
12778	Angle body	1/2" sweat x 3/8" compression

FIP x COMPRESSION



- Chrome brass finish

PART#	TYPE	DESCRIPTION
12779	Straight body	3/8" FIP x 3/8" compression
12783	Straight body	1/2" FIP x 3/8" compression
12780	Angle body	3/8" FIP x 3/8" compression
12784	Angle body	1/2" FIP x 3/8" compression

MIP x SWEAT



- Rough brass finish

PART#	DESCRIPTION
12804	1/2" MIP x 1/2" sweat
12805	3/4" MIP x 1/2" sweat
12806	3/8" MIP x 1/2" sweat
12807	3/8" MIP x 3/8" sweat

SEE PAGE g-6 FOR PEX X COMPRESSION

FITTING ADAPTERS

FAUCET ADAPTER



- Chrome brass finish

PART#	DESCRIPTION
12776	1/2" FIP x 5/8" compression

COMPRESSION UNION



- Chrome brass finish

PART#	DESCRIPTION
12775	1/4" compression x 1/4" compression
12774	3/8" compression x 3/8" compression
12789	1/2" compression x 1/2" compression
12790	5/8" compression x 5/8" compression

FIP x SWEAT



- Rough brass finish

PART#	DESCRIPTION
12800	1/2" FIP x 1/2" sweat
12801	3/8" FIP x 3/8" sweat
12802	3/4" FIP x 1/2" sweat
12803	3/8" FIP x 1/2" sweat

MIP x COMPRESSION



- Chrome brass finish

PART#	TYPE	DESCRIPTION
12787	Straight body	1/4" MIP x 3/8" compression
12781	Straight body	3/8" MIP x 3/8" compression
12785	Straight body	1/2" MIP x 3/8" compression
12788	Straight body	1/4" MIP x 1/4" compression
12782	Angle body	3/8" MIP x 3/8" compression
12786	Angle body	1/2" MIP x 3/8" compression

NOTES

PUSHFIT STOP VALVES

EASYGRIP STOP VALVE ANGLE 3/8" COMP



- Designed to simplify pipe installation
- Allows users to connect pipe in seconds
- Instant pushfit connection for ease of use
- Certified to 200 PSI and 200°F (93°C)
- Fits OD controlled CPVC, PEX and copper pipe
- Body composed of solid DZR brass
- Chrome plated
- Supplied with insert(s)
- 1 per bag packaging
- cUPC approved

EASYGRIP STOP VALVE STRAIGHT 3/8" COMP



- Designed to simplify pipe installation
- Allows users to connect pipe in seconds
- Instant pushfit connection for ease of use
- Certified to 200 psi and 200°F(93°C)
- Fits OD controlled CPVC, PEX and copper pipe
- Body composed of solid DZR brass
- Chrome plated
- Supplied with insert(s)
- 1 per bag packaging
- cUPC approved

PART#	DESCRIPTION	PART#	DESCRIPTION
69740	1/2" pushfit x 3/8" compression	69742	1/2" pushfit x 3/8" compression
<h3>EASYGRIP STOP VALVE, 3 WAY</h3> <div style="display: flex; justify-content: space-between; align-items: center;"> <div style="font-size: small;"> <ul style="list-style-type: none"> - Designed to simplify pipe installation - Allows users to connect pipe in seconds - Instant pushfit connection for ease of use - Certified to 200 PSI and 200°F (93°C) - Fits OD controlled CPVC, PEX and copper pipe - Body composed of solid DZR brass - Chrome plated - Supplied with insert(s) - 1 per bag packaging - cUPC approved </div> </div>		<h3>EASYGRIP STOP VALVE, 3 WAY</h3> <div style="display: flex; justify-content: space-between; align-items: center;"> <div style="font-size: small;"> <ul style="list-style-type: none"> - Designed to simplify pipe installation - Allows users to connect pipe in seconds - Instant pushfit connection for ease of use - Certified to 200 PSI and 200°F(93°C) - Fits OD controlled CPVC, PEX and copper pipe - Body composed of solid DZR brass - Chrome plated - Supplied with insert(s) - 1 per bag packaging - cUPC approved </div> </div>	
69747	1/2" pushfit x 3/8" x 3/8" compression	69748	1/2" pushfit x 1/4" x 3/8" compression
<h3>EASYGRIP STOP VALVE STRAIGHT 1/4" COMP</h3> <div style="display: flex; justify-content: space-between; align-items: center;"> <div style="font-size: small;"> <ul style="list-style-type: none"> - Designed to simplify pipe installation - Allows users to connect pipe in seconds - Instant pushfit connection for ease of use - Certified to 200 PSI and 200°F (93°C) - Fits OD controlled CPVC, PEX and copper pipe - Body composed of solid DZR brass - Chrome plated - Supplied with insert(s) - 1 per bag packaging - cUPC approved </div> </div>		<h3>EASYGRIP STOP VALVE ANGLE 1/4" COMP</h3> <div style="display: flex; justify-content: space-between; align-items: center;"> <div style="font-size: small;"> <ul style="list-style-type: none"> - Designed to simplify pipe installation - Allows users to connect pipe in seconds - Instant pushfit connection for ease of use - Certified to 200 PSI and 200°F (93°C) - Fits OD controlled CPVC, PEX and copper pipe - Body composed of solid DZR brass - Chrome plated - Supplied with insert(s) - 1 per bag packaging - cUPC approved </div> </div>	
PART#	DESCRIPTION	PART#	DESCRIPTION
69746	1/2" pushfit x 1/4" compression	69744	1/2" pushfit x 1/4" compression

PUSHFIT FITTINGS

EASYGRIP TEE



- Designed to simplify pipe installation
- Allows users to connect pipe in seconds
- Instant pushfit connection for ease of use
- Certified to 200 PSI and 200°F (93°C)
- Fits OD controlled CPVC, PEX and Copper pipe
- Body composed of solid DZR Brass
- Supplied with insert(s)
- cUPC and NSF approved

EASYGRIP END CAP



- Designed to simplify pipe installation
- Allows users to connect pipe in seconds
- Instant pushfit connection for ease of use
- Certified to 200 PSI and 200°F (93°C)
- Fits OD controlled CPVC, PEX and Copper pipe
- Body composed of solid DZR Brass
- Supplied with insert(s)
- cUPC and NSF approved

PART#	DESCRIPTION
69713	1/2" x 1/2" x 1/2" tee
69714	3/4" x 3/4" x 3/4" tee
69715	3/4" x 3/4" x 1/2" red - tee
69716	3/4" x 1/2" x 3/4" red - tee
69717	3/4" x 1/2" x 1/2" red - tee
69720	1" x 1" x 1" tee
69723	1" x 1" x 3/4" red - tee

PART#	DESCRIPTION
69718	1/2" end cap
69719	3/4" end cap
69727	1" end cap

EASYGRIP STRAIGHT COUPLING



- Designed to simplify pipe installation
- Allows users to connect pipe in seconds
- Instant pushfit connection for ease of use
- Certified to 200 PSI and 200°F (93°C)
- Fits OD controlled CPVC, PEX and copper pipe
- Body composed of solid DZR brass
- Supplied with insert(s)
- cUPC and NSF approved

EASYGRIP LONG REPAIR SLIP COUPLING



- Designed to simplify pipe installation
- Allows users to connect pipe in seconds
- Instant pushfit connection for ease of use
- Certified to 200 PSI and 200°F (93°C)
- Fits OD controlled CPVC, PEX and copper pipe
- Body composed of solid DZR brass
- Supplied with insert(s)
- cUPC and NSF approved

PART#	DESCRIPTION
69700	1/2" coupling
69701	3/4" coupling
69722	1" coupling
69702	3/4" x 1/2" reducing coupling
69721	1" x 3/4" reducing coupling

PART#	DESCRIPTION
69735	1/2" repair slip
69736	3/4" repair slip
69737	1" repair slip

PUSHFIT FITTINGS

EASYGRIP FEMALE IPS STRAIGHT CONNECTOR



- Designed to simplify pipe installation
- Allows users to connect pipe in seconds
- Instant pushfit connection for ease of use
- Certified to 200 PSI and 200°F (93°C)
- Fits OD controlled CPVC, PEX and copper pipe
- Body composed of solid DZR brass
- Supplied with insert(s)



PART#	DESCRIPTION
69703	1/2" x 1/2" FNPT
69704	3/4" x 3/4" FNPT
69705	1/2" x 3/4" FNPT
69725	1" x 1" FNPT

EASYGRIP MALE IPS STRAIGHT CONNECTOR



- Designed to simplify pipe installation
- Allows users to connect pipe in seconds
- Instant pushfit connection for ease of use
- Certified to 200 PSI and 200°F (93°C)
- Fits OD controlled CPVC, PEX and copper pipe
- Body composed of solid DZR brass
- Supplied with insert(s)



PART#	DESCRIPTION
69706	1/2" x 1/2" MNPT
69707	3/4" x 3/4" MNPT
69708	1/2" x 3/4" MNPT
69726	1" x 1" MNPT

EASYGRIP DROP EAR ELBOW



- Designed to simplify pipe installation
- Allows users to connect pipe in seconds
- Instant pushfit connection for ease of use
- Certified to 200 psi and 200°F (93°C)
- Fits OD controlled CPVC, PEX and copper pipe
- Body composed of solid DZR brass
- Supplied with insert(s)



PART#	DESCRIPTION
69712	1/2" x 1/2" FNPT

EASYGRIP ELBOW



- Designed to simplify pipe installation
- Allows users to connect pipe in seconds
- Instant pushfit connection for ease of use
- Certified to 200 psi and 200°F (93°C)
- Fits OD controlled CPVC, PEX and copper pipe
- Body composed of solid DZR brass
- Supplied with insert(s)



PART#	DESCRIPTION
69709	1/2" x 1/2" elbow
69710	3/4" x 3/4" elbow
69711	3/4" x 1/2" elbow
69724	1" x 1" elbow

EASYGRIP DISCONNECT TOOL



- Easy to use for removal of pipe from EASYGRIP fittings

PART#	DESCRIPTION
69731	1/2"
69732	3/4"
69733	1"

PUSHFIT FITTINGS

EASYGRIP BALL VALVE



- Designed to simplify pipe installation
- Allows users to connect pipe in seconds
- Instant pushfit connection for ease of use
- Certified to 200 PSI and 200°F (93°C)
- Fits OD controlled CPVC, PEX and copper pipe
- Body composed of solid DZR brass
- Supplied with insert(s)
- cUPC and NSF approved



PART#	DESCRIPTION
69728	1/2" ball valve
69729	3/4" ball valve
69730	1" ball valve

EASYGRIP BALL VALVE IPS WITH DRAIN



- Designed to simplify pipe installation
- Allows users to connect pipe in seconds
- Instant pushfit connection for ease of use
- Certified to 200 PSI and 200°F (93°C)
- Fits OD controlled CPVC, PEX and copper pipe
- Body composed of solid DZR brass
- Supplied with insert(s)
- cUPC and NSF approved



PART#	DESCRIPTION
69739	1/2" ball valve with drain

EASYGRIP CHECK VALVE



- Designed to simplify pipe installation
- Allows users to connect pipe in seconds
- Instant pushfit connection for ease of use
- Certified to 200 PSI and 200°F (93°C)
- Fits OD controlled CPVC, PEX and copper pipe
- Body composed of solid DZR brass
- Supplied with insert(s)
- cUPC approved



PART#	DESCRIPTION
69690	1/2" check valve
69691	3/4" check valve
69692	1" check valve

EASYGRIP FLEXIBLE BRAIDED STAINLESS STEEL WATER HEATER SUPPLY CONNECTORS



- Used in residential and commercial applications
- Connects the hot and cold supply lines to the water heater
- Connectors are EPDM knitted with braided stainless steel
- Connectors are 3/4" FIP x 3/4"
- Can connect to copper (ASTM B88), PEX (ASTM F876) and CPVC (ASTM D2846) tubing (eliminates the need for additional transition fitting)
- cUPC approved



PART#	DESCRIPTION
55588	3/4" FIP x 3/4" push fit x 18"
55589	3/4" FIP x 3/4" push fit x 24"

PEX ELBOWS - BRASS

PEX ELBOW



- PEX brass elbows make tight 90-degree connections for PEX tubing in supply and return mains

PART#	DESCRIPTION
69500	1/2"
69501	1/2" x 3/4"
69502	3/4"
69503	1"

PEX DROP EAR ELBOW



- PEX drop ear brass elbow provides rigid 90-degree connections and the ability to secure PEX tubing

PART#	DESCRIPTION
69521	1/2" PEX x 1/2" FPT

PEX SWEAT ELBOW



- PEX sweat elbows make tight 90-degree connections for PEX tubing in supply and return mains

PART#	DESCRIPTION
69535	1/2" PEX x 1/2" male sweat
69536	1/2" PEX x 1/2" female sweat

PEX MALE THREAD ELBOW



- PEX male thread elbow provides rigid 90-degree connections and the ability to secure PEX tubing

PART#	DESCRIPTION
69537	1/2" PEX x 1/2" male thread

FOR A WIDE SELECTION OF PEX TOOLS SEE PAGE L-1

PEX FITTINGS - BRASS

PEX TEE



- Tee Descriptions = (end) x (end) x (middle)
- PEX brass tees make diverting connections for PEX tubing in supply and return mains
- CSA approved

PART#	END	END	MIDDLE
69504	1/2"	1/2"	1/2"
69505	1/2"	1/2"	3/4"
69506	3/4"	1/2"	1/2"
69507	3/4"	1/2"	3/4"
69508	3/4"	3/4"	1/2"
69509	3/4"	3/4"	3/4"
69510	1"	3/4"	3/4"
69511	1"	1"	3/4"
69512	1"	1"	1"

FITTING ADAPTERS 1/2" PEX X 3/8" COMPRESSION



part#12765



part#12766

- Chrome brass fittings
- Straight or angle
- One per hang tag bag package

PART#	DESCRIPTION
12765	Straight, 1/2" PEX x 3/8 comp.
12766	Angle, 1/2" PEX x 3/8 comp.

PEX COUPLING



- PEX Brass Coupling makes PEX-to-PEX connections for PEX tubing
- CSA approved

PART#	DESCRIPTION
69513	1/2" x 1/2" PEX
69514	1/2" x 3/4" PEX
69515	3/4" x 3/4" PEX
69516	1" x 1" PEX
69517	1/2" PEX x 1/2" poly b.
69518	3/4" PEX x 3/4" poly b.

PEX FITTINGS - BRASS

PEX FEMALE ADAPTERS



- PEX to brass female NPT threaded adapter connects PEX tubing to male NPT threads
- CSA approved

PEX MALE ADAPTERS



- PEX to brass male NPT threaded adapter connects PEX tubing to male NPT threads
- CSA approved

PART#	DESCRIPTION
69531	1/2" PEX x 1/2" FPT
69532	1/2" PEX x 3/4" FPT
69533	3/4" PEX x 3/4" FPT
69534	3/4" PEX x 1" FPT

PART#	DESCRIPTION
69527	1/2" PEX x 1/2" MPT
69528	1/2" PEX x 3/4" MPT
69529	3/4" PEX x 3/4" MPT
69530	1" PEX x 1" MPT

PEX FEMALE SWEAT ADAPTERS



- PEX brass sweat adapter transitions PEX tubing to copper pipe
- CSA approved

PEX MALE SWEAT ADAPTERS



- PEX brass sweat adapter transitions PEX tubing to copper pipe
- CSA approved

PART#	DESCRIPTION
69524	1/2" x 1/2" sweat
69525	3/4" x 3/4" sweat
69526	1" x 1" sweat

PART#	DESCRIPTION
69522	1/2" x 1/2" sweat
69523	3/4" x 3/4" sweat

PEX BEND SUPPORT



- Plastic bend supports provide rigid 90 degree bend for PEX tubing
- Made of reinforced nylon

PEX PLUG



- PEX brass plugs terminate the end of PEX tubing
- Plugs are installed for temporary or permanent usage
- CSA approved

PART#	DESCRIPTION
1096	1/2" support
1097	3/4" support

PART#	DESCRIPTION
69519	1/2" plug
69520	3/4" plug

PEX FITTINGS - BRASS

PEX SHOWER ELBOW



- Brass elbow for fiberglass / acrylic showers
- Securely mounts the shower arm or tub spout nipple to the shower
- Locknuts secure elbows to wall of shower
- 1-1/32" hole required in shower for use
- PEX connection in 1/2" or 3/4" PEX
- For IPS & sweat equivalent see **page E-7**

PART#	DESCRIPTION
-------	-------------

1196	1/2" PEX - packaged
1197	3/4" PEX - packaged
1196Q	1/2" PEX - bulk
1197Q	3/4" PEX - bulk

PEX CLAMP CTS 2H SUSPENSION



- Black Poly PEX clamps

PART#	DESCRIPTION
-------	-------------

69606	1/2"
69607	3/4"
69608	1"
69609	1-1/4"
69610	1-1/2"
69611	2"

PEX CLAMP SUSPENSION PIPE



- Black poly PEX clamps

PART#	DESCRIPTION
-------	-------------

69600	1/2"
69601	3/4"
69602	1"
69603	1-1/4"
69604	1-1/2"
69605	2"

PEX J CLAMP



- J clamps connect PEX tubing to wood surfaces

PART#	DESCRIPTION
-------	-------------

1093	1/2"
1094	3/4"
1095	1"

PEX FITTINGS - PLASTIC

PEX ELBOW



- Poly alloy plastic
- Certified to CSA B137.5
- Resistant to chlorine and scaling
- Off white in colour
- Poly bag packaged
- Warnock Hersey approved

PART#	DESCRIPTION
69802	3/4" x 1/2" elbow
69803	1/2" elbow
69804	3/4" elbow

PEX PLUG



- Poly alloy plastic
- Certified to CSA B137.5
- Resistant to chlorine and scaling
- Off white in colour
- Poly bag packaged
- Warnock Hersey approved

PART#	DESCRIPTION
69813	1/2" plug
69814	3/4" plug

PEX FEMALE PLASTIC ADAPTORS SWIVEL



- Poly Alloy Plastic
- Certified to CSA B137.5
- Resistant to chlorine and scaling
- Off white in colour
- Poly bag packaged
- Warnock Hersey approved

PART#	DESCRIPTION
69815	1/2" FPT swivel x 1/2" adaptor
69816	3/4" FPT swivel x 3/4" adaptor

PEX MALE PLASTIC ADAPTORS



- Poly Alloy Plastic
- Certified to CSA B137.5
- Resistant to chlorine and scaling
- Off white in colour
- Poly bag packaged
- Warnock Hersey approved

PART#	DESCRIPTION
69809	1/2" MPT x 1/2" adaptor
69810	3/4" MPT x 3/4" adaptor
69811	3/4" MPT x 1/2" adaptor
69812	1/2" MPT x 3/4" adaptor

PEX FITTINGS

PEX TEE



- Poly alloy plastic
- Certified to CSA B137.5
- Resistant to chlorine as scaling
- Off white in colour
- Use same tools and brass fittings
- Poly bag packaged
- Warnock Hersey approved

PART#	DESCRIPTION
69800	1/2" tee
69801	3/4" tee

PEX REDUCING TEE



- Poly alloy plastic
- Certified to CSA B137.5
- Resistant to chlorine and scaling
- Off white in colour
- Use same tools and brass fittings
- Poly bag packaged
- Warnock Hersey approved

PART#	DESCRIPTION
69817	1/2" x 1/2" x 3/4" tee
69818	3/4" x 1/2" x 1/2" tee
69819	3/4" x 1/2" x 3/4" tee
69820	3/4" x 3/4" x 1/2" tee

PEX SWIVEL ELBOW



- Poly alloy plastic
- Certified to CSA B137.5
- Resistant to chlorine and scaling
- Off white in colour
- Use same tools and brass fittings
- Poly bag packaged
- Warnock Hersey approved

PART#	DESCRIPTION
69805	1/2" FPT swivel x 1/2" elbow

PEX COUPLING



- Poly alloy plastic
- Certified to CSA B137.5
- Resistant to chlorine and scaling
- Off white in colour
- Use same tools and brass fittings
- Poly bag packaged
- Warnock Hersey approved

PART#	DESCRIPTION
69806	1/2" coupling
69807	3/4" coupling
69808	3/4" x 1/2" coupling

PEX FITTINGS

OETIKER PEX CLINCH CLAMP



- LYNCAR offers the OETIKER clinch clamp
- Stainless steel - 530400 Grade
- Made in the U.S.A
- NSF approved



PART#	DESCRIPTION
-------	-------------

1090	1/2"
1089	5/8"
1092	3/4"
1098	1"

PEX RING STAINLESS STEEL CLAMP



- LYNCAR "Clinch Clamp"
- Stainless steel
- Meets CSA B137.5 and ASTM F2098 standards
- Sold 100 per bag
- NSF approved



PART#	DESCRIPTION
-------	-------------

109212	1/2" Stainless steel PEX clamp
109234	3/4" Stainless steel PEX clamp

PEX COPPER COMPRESSION RING



- Packs as 100 per bag for contractor use
- WARNOCK HERSEY approved to CSA B137.5



PART#	DESCRIPTION
-------	-------------

7994	3/8"
7991	1/2"
7992	3/4"
7993	1"

PEX STUB OUT ELBOWS WITH STRAPS



- Quality assurance
- 100% air-pressure tested
- Guaranteed leak-proof
- Perfect bending (no deformation) ensure better flow
- 1-1/4 radius bend for better fit inside 2 x 4 walls
- NSF, CSA and cUPC approved



PART#	CONNECTION	A	B	C	D
69757	3/8" PEX	3-1/2"	6"	1-1/4"	1-3/4"
69758	1/2" PEX	3-1/2"	6"	1-1/4"	1-3/4"
69759	1/2" PEX	3-1/2"	8"	1-1/4"	1-3/4"
69760	3/4" PEX	4"	8"	1-3/4"	2"

PEX BALL VALVES

PEX 1/4 TURN STOP - ANGLE



- 1/4 turn stop valves for PEX
- Chrome plated
- CSA approved

PART#	DESCRIPTION
3346	1/2" PEX x 3/8" comp.
3350	1/2" PEX x 1/4" OD comp.

PEX 1/4 TURN STOP - STRAIGHT



- 1/4 turn stop valves for PEX
- Straight or angle
- Chrome plated
- CSA approved

PART#	DESCRIPTION
3344	1/2" PEX x 3/8" comp.
3343	1/2" PEX x 1/2" PEX
3349	1/2" PEX x 1/4" OD comp.

PEX STOP - ANGLE



- Compression stops for PEX
- Chrome plated
- CSA approved

PART#	DESCRIPTION
12662	1/2" PEX x 3/8" comp.

PEX STOPS - STRAIGHT



- Compression stops for PEX
- Chrome plated
- CSA approved

PART#	DESCRIPTION
12666	1/2" PEX x 3/8" comp.
12667	1/2" PEX x 1/2" PEX

PEX BALL VALVES

PEX BALL VALVE



- LYNCAR'S ball valve with PEX ends
- Available in two sizes
- Brass body
- 600WOG

PEX BALL VALVE - WITH DRAIN



- LYNCAR'S ball valve with PEX ends
- Available in two sizes
- Brass body
- 600WOG
- With drain

PART#	DESCRIPTION
3347	1/2" PEX
3348	3/4" PEX

PART#	DESCRIPTION
3347D	1/2" PEX with drain
3348D	3/4" PEX with drain

PEX BALL VALVE - BRASS MINI



- LYNCAR'S mini ball valve with PEX ends
- Available in three sizes
- Brass body chrome brass handle
- CSA approved

PEX BALL VALVE - BRASS MINI



- LYNCAR'S mini ball valve with PEX ends
- Available in three sizes
- Brass body chrome brass handle
- CSA approved

PART#	SIZE
3345	1/2" PEX, angle

PART#	SIZE
3340	3/8" PEX, straight
3341	1/2" PEX, straight
3342	3/4" PEX, straight

SWEAT x PEX BALL VALVE



- LYNCAR'S ball valve with copper x PEX ends
- Available in two sizes
- Brass body
- 600WOG

PEX FROST FREE FAUCET WITH BUILT IN BREAKER



- Chrome Brass
- Frost Free with Breaker
- Self Draining
- 1/2" PEX
- CSA Approved

PART#	DESCRIPTION
3347CXP	1/2" copper x PEX
3348CXP	3/4" copper x PEX

PART#	DESCRIPTION
806508P	8" long
806510P	10" long
806512P	12" long
806514P	14" long

PEX VALVES

SEDIMENT FAUCET WITH PEX



- 1/2" thread or PEX connection
- 3/4" MHT outlet
- NSF61 listed

PART#	DESCRIPTION
3389	Boiler drain valve

SILCOCK VALVE WITH PEX



- 1/2" PEX end connection
- 3/4" MHT
- With flange

PART#	DESCRIPTION
3388	Sillcock valve, PEX end

SILCOCK VALVE WITH PEX 1/4 TURN



- 1/2" PEX end connection
- 3/4" MHT
- With flange
- cUPC approved

PART#	DESCRIPTION
3390	Sillcock valve, PEX end 1/4 turn

GEL GLOSS PRODUCTS

GEL-GLOSS

Retail Friendly Size



- Combines the most powerful non-abrasive cleaning agents with the most effective Carnauba waxes to produce the highest surface luster possible
- Removes surface scratches and oxidation while providing a long lasting protective finish. Excellent for sinks, basins, countertops, tubs, spas, RV's, boats, shower doors, stainless steel and porcelain
- Recommended for cleaning and maintenance of gel-coated surfaces

PART#	SIZE FORMAT
31308	8 oz squeeze bottle
3129	2 oz squeeze bottle

GEL-GLOSS ORIGINAL FORMAT



- GEL GLOSS in 16 oz can or 12 oz aerosol

PART#	SIZE FORMAT
3130	16 oz can
3131	12 oz aerosol spray

FAUCET BRITE



- For use on decorator bath fixtures
- Use with confidence on decorative bath fixtures, chrome and painted surfaces
- Faucet Brite cleans and seals, leaving behind a protective coating that resists tarnishing and improves water repellence
- This is a specially formulated utilizing polymer resin technology to enhance the beauty and protect the surface of coated fixtures

PART #	SIZE FORMAT
3127	2 oz squeeze bottle
31288	8 oz bottle

GEL GLOSS DISPLAYS



- Great for impulse sales at your counter or store

PART#	SIZE
31310	2 oz squeeze bottle
	18 pcs GEL GLOSS
	9 pcs faucet brite polisher 9 pcs no streak glass cleaner
31315	8 oz bottles
	12 pcs GEL GLOSS
	6 pcs faucet brite polisher
	6 pcs no streak glass cleaner

CHIMNEY BRUSHES

NO STREEK



- Amazing NO STREEK glass polish cleans and polishes in one convenient, easy application - keeping the promise that ordinary spray cleaners cannot
- Use NO STREEK for superior finishes on all glass, chrome and metal surfaces
- Fantastic on mirrors, too! a true professional grade polish, NO STREEK cleans cleaner and shines better - and works harder on hard water spots
- IT WORKS...EVEN IN DIRECT SUNLIGHT!

PART #	DESCRIPTION
3133	2 oz squeeze bottle
3138	8 oz bottle

POWER FITTING BRUSH



- Carbon steel - single spiral / single stem
- Power fitting brush with hex shaft. Hex locks into all standard and quick lock type chucks for easy change over

PART #	DESCRIPTION
5134	1/2" size
5135	3/4" size
5136	1" size

MASTER CLEAN - DOUBLE SPIRAL / DOUBLE STEM

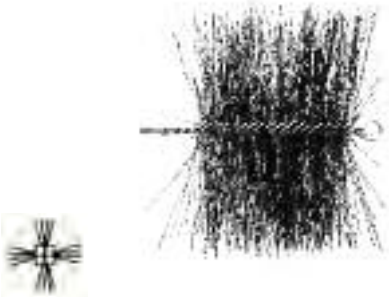

- Double spiral tempered steel wire brush with heavy duty stem and 3/8" male pipe thread.
- Double spiral/double stem (4 wires)
- Brush bristles are twisted between four stem wires with two layers of bristles
- Each layer is perpendicular to the other with a single stem wire in each quadrant

PART #	DESCRIPTION
43401	Round - 8"
43405	Square - 8"

**FIBRE FILLED FURNACE & BOILER BRUSHES
SINGLE SPIRAL / SINGLE STEM**



- Extra heavy fill, 6" long brush part with wooden handle.
- Single spiral / single stem (2 wires)
- Brush bristles are twisted between two stem wires with a single wire on each side

PART #	DESCRIPTION
43370	2" x 27" brush size
43371	3" x 27" brush size
43372	2" x 42" brush size
43373	3" x 42" brush size

CHIMNEY BRUSHES

PREMIUM BRUSH - SINGLE SPIRAL / DOUBLE STEM

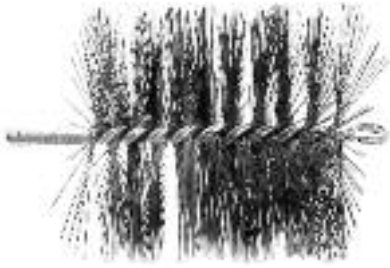

- Single spiral polypropylene bristle brush with heavy duty stem and 3/8" male pipe thread.
- Single spiral/double stem (4 wires)
- Brush bristles are twisted between four stem wires with two stem wires on each side

PART #	TYPE	SIZE
43391	Round	6"
43392	Round	7"
43393	Round	8"
43394	Square	7"
43395	Square	8"

MASTER CLEAN - DOUBLE SPIRAL / DOUBLE STEM

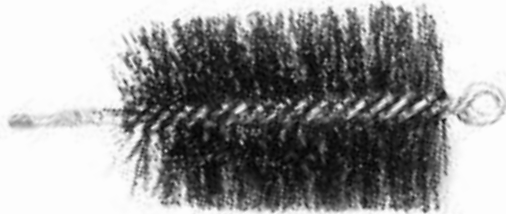

- 4-1/2" long spring grade tempered wire brush part, 1/4" male pipe thread.
- Double spiral/double stem (4 wires)
- Brush bristles are twisted between four stem wires with two layers of bristles
- Each layer is perpendicular to the other with a single stem wire in each quadrant

PART#	FLUE SIZE	BRUSH DIAMETER
43306	1"	3/4"
43308	1-1/4"	1"
43312	1-1/2"	1-1/4"
43314	1-3/4"	1-1/2"
43316	2"	1-3/4"
43326	3"	2-3/4"
43336	4"	3-3/4"

PREMIUM BRUSH - SINGLE SPIRAL / DOUBLE STEM



- 4-1/2" long spring grade tempered wire brush part, 1/4" male pipe thread
- Other sizes are available, please call. Brushes are also available in stainless steel
- Single spiral/double stem (4 wires)
- Brush bristles are twisted between four stem wires with two stem wires on each side.

PART #	FLUE SIZE	BRUSH DIAMETER
43206	1"	3/4"
43208	1-1/4"	1"
43212	1-1/2"	1-1/4"
43214	1-3/4"	1-1/2"
43216	2"	1-3/4"
43226	3"	2-3/4"
43236	4"	3-3/4"

BRuSHES

BRuSH RODS & HANDLES

- For brushes we offer both handles and extensions in steel & fiberglass to complete your requirements



Loop Steel Handle



Steel Extension Rod



Fiberglass Rod

PART#	FLuE SIZE	BRuSH DIAMETER
43375	48"	Loop steel handle - female 1/4" IPS end
43376	72"	Loop steel handle - female 1/4" IPS End
43377	48"	Steel extension rod - male x female 1/4" IPS
43378	72"	Steel extension rod - male x female 1/4" IPS
43384		T-handle 1/4" IPS
43380	48"	Fiberglass rod - female 1/4" IPS
43381	72"	Fiberglass rod - female 1/4" IPS
43382	48"	Fiberglass rod - female 3/8" IPS
43383	72"	Fiberglass rod - female 3/8" IPS
43384		T-handle 1/4" IPS
43385		T-handle 3/8" IPS

BRuSH - uTILITY (CHIP & OIL)



- White chinese bristle, metal ferrule, plain sanded wood handle
- Low priced economy import.

PART #	DIAMETER
4645	1/2"
4647	1"
4649	2"

DOPE BRuSH - wOOD HANDLE



- Select horsehair bristles secured tightly in metal ferrule, round sanded wood handle
-#7 brushes sold 36 pieces per box

PART #	SIZE	LENGTH
4653	# 7 wood	5-13/16"

BRuSHES

ACID BRuSH - NATuRAL BRISTLE

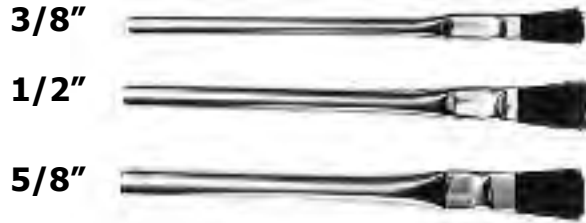

- Select horsehair bristles are pressed securely in tin handles.
 - #1, #2, #4 Brushes sold 144 pieces per box

PART #	SIZE	BRISTLE wIDTH	HANDLE LENGTH
4650	# 1	3/8"	5-1/4"
4651	# 2	1/2"	5-1/2"
4652	# 4	5/8"	6-7/8"

wIRE BRuSH - CuRvED HANDLE



- 14" hardwood block filled with 3 Rows x 19
 - Tufts of tempered steel bristles

PART #	DESCRIPTION
4480	Wire brush - curved handle

BRuSH - uTILITy



- 3 x 7 rows, 1/2" trim
 - 7" long plastic block with 1-1/2" long brush end

PART #	DESCRIPTION
5137	Steel bristles
5138	Brass bristles

wIRE BRuSH - SHOe HANDLE



- 10" hardwood block filled with 4 Rows x 17
 - Tufts of tempered steel bristles

PART #	DESCRIPTION
4482	Wire brush - shoe handle

PIPE DOPE

PROSEAL PLUS TEFLON PASTE



- Approved for BLAZEMASTER®
- PSI: 0 - 10,000psi
- Temperature range: -50°F to +500°F
- Colour: off white
- Shelf life: infinite
- Material: Teflon filled, synthetic compound
- Resists:
 - Water
 - Steam
 - Air
- Not suitable for use with oxygen
- Anti-seizing, chemically inert, non-hardening, non-corrosive, non drying
- Lubricates, protects and seals threads and fittings of:
 - Stainless Steel
 - Nickel
 - Synthetic rubbers
 - Brass
 - Galvanized iron
 - Monel
 - Aluminum
 - Alloys
 - Coppers
 - Plastics

PART #	DESCRIPTION	UNITS
506250PBT	250ml BT can	24
506500PBT	500ml BT can	12
506000P	1 litre can	12

THREADING OIL & THREADING COMPOUND

PROBLUE THREAD COMPOUND



NONTOXIC  NUN-TOXIQUE

LYNCAR Products

ProBlue Industrial 

PIPE THREAD COMPOUND

“For a Positive Leakproof Seal”
“Pour un joint sûr et ultra-étanche”



- PROBLUE is a non teflon based pipe thread sealant that can be used on PVC, ABS & CPVC plastic pipe, and also metal pipe
- Lubricates during assembly! Non hardening
- ULC Approved

PART #	SIZE	uNITS
509250	250ml BT can	24
509500	500ml BT can	12
509100	1 litre can	12

CHEMICAL & SHOP

THREADING OIL



LYNCAR Products

ProThread Industrial

Pipe Threading Oil
Huile A Filage

*Better Quality Threads
& Longer Die Life*



- LYNCAR'S pipe threading oil is NOT cutting oil
- It is formulated for threading pipe. Either hand threading or machine threading our formula will result in better quality threads and longer die life !

PART #	SIZE	uNITS
506011	1 litre bottle	12
506010	4 litre jug	4
506015	20 litre pail	1
5060205	205 litre drum	1

CHEMICALS & SHOP SUPPLIES

TEFLON TAPE - WHITE



- Superior quality teflon tape

TEFLON TAPE - PINK



- Heavy duty tape
- Superior density & thickness

PART#	DESCRIPTION	CASE
506065	1/2" x 480	100
506034	3/4" x 520	70
506080	1" x 520	50

PART#	DESCRIPTION	CASE
506070	1/2" x 520	250
506072	3/4" x 520	70

TEFLON TAPE - yellow GAS LINE



- 1/2" x 260" yellow
- Heavy duty tape
- Superior density & thickness
- 100 rolls-per-box
- Specifically designed to seal threads in natural gas, propane, butane, kerosene and petroleum oil lines
- For use on threads not exceeding 1-1/2"
- CSA approved

TEFLON TAPE - ORANGE



- Premium teflon tape in orange
- High density and extra thick
- For natural and LP gases
- CSA approved

PART#	DESCRIPTION	CASE
506075	1/2" x 260	100

PART#	DESCRIPTION	CASE
506090	1/2" x 540	50
506095	1/2" x 1296	50

ANAEROBIC TEFLON PASTE - ALL PURPOSE



- This is a general purpose all use anaerobic teflon paste product
- Use in many different applications.
- Instant seal up to 100 PSI, full cure up to 10,000 PSI
- No drip consistency, can be applied directly to hot and oily pipe threads

ANAEROBIC TEFLON PASTE - LOW STRENGTH



- This is a special formula anaerobic teflon paste used mainly for fire sprinkler head installation
- It will easily disassemble after setting, for repositioning and adjusting of wall mount sprinkler heads
- Will not break CPVC reducers or crack pipe

PART #	DESCRIPTION	CASE
501635	350ml BT can	12
501675	750 BT can	8

PART#	DESCRIPTION	CASE
501735	350ml BT can	12
501775	750 BT can	8

DISPOSABLE GLOVES

LATEX DISPOSABLE GLOVES - INDUSTRIAL GRADE



- Premium quality
- Excellent resistance to a variety of chemicals
- First rate elasticity and flexibility
- Good touch sensitivity providing a strong grip
- 100 Per box, Sold by the box
- XL size

PART#	DESCRIPTION
950	Latex disposable gloves - industrial grade

VINYL DISPOSABLE GLOVES - INDUSTRIAL GRADE



- Latex free
- Tan colour
- Made from premium quality vinyl
- Excellent resistance to a variety of chemicals
- Stretches more than conventional vinyl gloves
- 100 Per box, sold by the box

PART#	DESCRIPTION
9552	Vinyl disposable gloves - industrial grade

NITRILE DISPOSABLE GLOVES



- Dark blue colour
- Premium medical quality
- Nitrile, 4mil thick
- 100/box, sold by the box

PART#	DESCRIPTION
9596	Nitrile gloves

BLACK NITRILE EXAMINATION DISPOSABLE GLOVE



- Powder free, chlorinated, textured
- Resistant to oils, detergents and solvents
- Stronger and more tear and puncture resistant than vinyl or latex gloves
- 4 mil thick, 9-1/2" long, 100 pairs per box

PART#	DESCRIPTION
9570	Large
9571	XL
9572	XXL (90/box)

CHEMICALS & SHOP SUPPLIES

NITRILE FOAM COATED NYLON GLOVES



- Foam Nitrile Coated Nylon Gloves
- Black on black
- Ideal for handling sensitive parts & materials
- Sold 12 per box

PART#	DESCRIPTION
9561	Nitrile coated gloves

LIGHT DUTY, NATURAL LATEX GLOVES - LINED



- 16 mil
- 100% cotton lined for added comfort
- Good strength for a longer lasting glove
- Excellent resistance to a variety of chemicals
- 12 pair per bag / 24 per carton

PART#	DESCRIPTION
9553	Light duty, natural latex gloves - lined

NITRILE GLOVES - UNLINED



- 15 mil
- Latex Free
- Excellent resistance to abrasion, cuts, snags, punctures, aging and gas.
- High level of flexibility and easy finger movement
- 12 pair per bag

PART#	DESCRIPTION
9554	Nitrile gloves - unlined

CHEMICALS & SHOP SUPPLIES

H

DuST MASK - DISPOSABLE



- Cone shaped mask
- Elastic strip
- 50 per box

PART#	DESCRIPTION
EDM50	Dust mask - disposable

SHOE COVERS, DISPOSABLE



- Non-woven polypropylene shoe covers
- Textured bottom for skid resistance
- Elastic on top for easier on/off
- Extra pliable material for greater flexibility in movement
- 100 per bag, sold by the bag

PART#	DESCRIPTION
9550	Shoe covers, disposable

CLEANING RAGS



- LYNCAR mixed cotton rags.
- Use in your shop, van

PART#	SIZE
608506	25 LB bag
608507	10 LB bag

EAR PLUGS - DISPOSABLE



- Cylindrical earplugs are made from a higher tech, brand new premium PVC foam
- It generates lower inner ear pressure.
- Military approved for its lack of moisture susceptibility
- Slower "recovery time" allows for deeper insertion and a more secure fit
- Plugs are uncorded.
- NRR 29 noise reduction rating
- 200 pairs per box, packaged in poly bags

PART#	DESCRIPTION
EAR100	Ear plugs - disposable

CHEMICAL & SHOP

GLOVES

LATEX COATED KNITTED GLOVE



- Comfortable
- Excellent wet or dry grip
- Blue colour latex coating
- 12 pairs per bag

SPLIT LEATHER GLOVES



- # 1 best seller
- Grey leather palm with 100% cotton back
- Reinforced finger tips and knuckle strap
- 2-1/2 safety cuff

PART#	DESCRIPTION
9555	Latex coated knitted glove

PART#	DESCRIPTION
5232	Split leather gloves

COTTON GLOVES



- 8 oz. canvas cotton glove
- Chute cut with knit wrist,
- Can be washed and reused

GLOVES - DRIVER'S



- Rich grain cowhide face and back with cotton shirring
- Large ONLY

PART#	DESCRIPTION
641	Cotton gloves

PART#	DESCRIPTION
1213	Gloves - driver's

GLOVES - PLASTIC DOT



- 8 oz. cotton glove
- Stronger grip with PVC dots
- Glove breathability pulls sweat away from hands for comfort

KNIT ANTI-SLIP GRIP GLOVES



- Black dot coating on seamless cotton knit
- Standard weight
- Unique PVC coating processes provide sure gripping ability and excellent abrasion resistance for gloves that are comfortably pliable and reduce hand, arm and back fatigue.

PART#	DESCRIPTION
5501	Gloves - plastic dot

PART#	DESCRIPTION
640	Knit anti-slip grip gloves

LINED SPLIT LEATHER GLOVES



- Lined with 3M "Thinsulate Lining"
- Grey leather palm with 100% cotton back
- Reinforced finger tips and knuckle strap
- 2-1/2 safety cuff

JERSEY GLOVE



- Knit wrist jersey in seal brown 9oz. fabric
- Cold weather favourite!

PART#	DESCRIPTION
5233	Lined split leather gloves

PART#	DESCRIPTION
403	Jersey glove

kNEE PADS & SuPPORT

kNEE PAD - HEAVy DuTy



- Super lightweight comfort
- Single adjustable 1-1/2" wide velcro strap
- Thick, soft inner lining
- Blue colour

PART#	DESCRIPTION
9223	Knee pad - heavy duty

kNEE PAD - TRADESMAN



- Super lightweight comfort
- Double adjustable straps
- Extra foam protection
- Thick, soft inner lining
- Blue colour

PART#	DESCRIPTION
9224	Knee pad - tradesman

kNEE PAD - BuILDERS



- Accordion top design helps secure the kneepad in position as you get up and down
- Straps are comfortable/easy to adjust
- Durable outer cover
- Upper strap eliminates debris from entering the top of the kneepad

PART#	DESCRIPTION
9220	Knee pad - builders

CHEMICALS & SHOP SUPPLIES

GAS LEAK DETECTOR - By LynCAR



Formulated to locate gas leaks in pipe lines, valves, pressure vessels, cylinders, tanks, etc. After applying leak detector directly from container to exterior surface, large bubbles will appear if there is gas escaping. May be used to find leaks of air, natural gas, refrigerants, CO2 and most other gases. This product is non-toxic, non-flammable and non-freezing to 10°F.

PART#	DESCRIPTION
59082	1oz bottle
59083	237ml dabber top
59085	473ml spray top

EASE - ON COUPLING GREASE



- LYNCAR'S EASE-ON grease, for mechanical couplings.
- 908 gram tubs and 12 per case
- NSF ANSI N5F61

PART#	DESCRIPTION
506060	EASE - ON coupling grease

LuBRICATING OIL



- An all purpose oil for use on motors, bearings and wherever metal lubrication is desired.
- Contains rust and corrosion preventatives
- Not for use on internal combustion engines or extreme heat producing operations
- Packaged with a telescopic spout so oil can be applied in hard to reach places

PART#	DESCRIPTION
59084	4 oz. bottle

CHEMICALS & SHOP SUPPLIES

H

PROTOWEL - TOUGH WIPE



- A strong abrasive towel impregnated with hand cleaner
- Formulated to remove adhesives, sealants, spray paints, enamels, latex paint, grease tar, ink and much more
- Can be used to clean hands, tools, equipment, desk tops, etc.
- Size: 10" x 12-1/2"
- 70 count rolls

PART#	DESCRIPTION	CASE
59080	70 wipes	6

STEM LUBE HEAT PROOF GREASE



- Specially formulated for use on all metal faucets and valve stems carrying air, steam, and hot or cold water
- Also lubricates ballcocks, plungers, packings and washers
- Can be used on potable water since it is safe and nontoxic

PART#	DESCRIPTION
3155	Stem lube heat proof grease

**x SEAL 3C AF (ASBESTOS FREE)
COLD CAULKING COMPOUND CORD**



- Asbestos-free
- Sulphate resistant
- Ready for use - no mixing
- Quick and easy to apply
- Can be used in damp conditions
- Provides an immediate seal
- Withstands pressures in excess of 6.9 N/Mm² (1000 Lbf/In²)
- Accommodates vibration and limited expansion and deflection movement
- Resistant to biological degradation
- Cord eliminates wastage
- Product previously known as PC4

PART#	DESCRIPTION
2895	2 m. length
2896	3k tin, 14m. approximately

CHEMICAL & SHOP

SILICONE SEALANTS

SILICONE SEALANT



- LYNCAR'S 100% Silicone, and kitchen and bath comes in 300ml tubes in white, clear, and grey. stays flexible, won't crack or peel, 40 year expected lifetime
- Adheres to most surfaces
- Kitchen & bath features a watertight & mildew resistance
- Siliconized is a lower cost product with a 25 year expected lifetime
- All Silicone products are in a 12 tube (300ml) display box

PART#	DESCRIPTION	COLOuR
39001	Silicone	CLEAR
39002	Silicone	WHITE
39003	Silicone	GREY
39301	Kitchen & bath	CLEAR
39302	Kitchen & bath	WHITE
39303	Kitchen & bath	GREY
39304	Kitchen & bath	ALMOND
39401	Siliconized	CLEAR
39402	Siliconized	WHITE

SILICONE TuBE



- Super soft
- Stainless
- Never hardens
- White colour

PART#	SIZE	CASE
39222	162ml tube silicone	12/case

uNIvERSAL wATER SOLuBLE SOLDER FLux



- LYNCAR'S "S-39" is a completely water soluble, flushable, self cleaning flux for soldering copper lines in plumbing.
- "S-39" is an acid free, lead free, liquid soldering flux, that is suitable on all types of tin solder (from 40/60 to lead free), copper, brass, polished chrome, steel, zinc, nickel, galvanized iron, silver, tin, lead and their alloys

PART#	SIZE	CASE
506057	80 ml	16
506058	320 ml	12

MAGIC wRAP



- Emergency repair kit on a roll
- 1" x 16' roll
- Stretches to 3 times its length
- Non adhesive
- Soft bonding
- Water & air tight
- Temperature resistant

PART#	DESCRIPTION
59054	Magic wrap

CHEMICALS & SHOP SUPPLIES

H

CANDLE WICKING



- Seals bonnet nuts
- Lubricates stems
- Random length

PART#	DESCRIPTION
2872	Candle wicking

GRAPHITE PACKING



- A round cord formable and flexible gasketing material made from pure 100% P.T.F.E. It is used for valve stem packing and flange gasketing applications
- Highly conformable will not seize, has excellent chemical resistance and operates from temperatures -400° F to +600° F
- Not intended for food contact applications

PART#	SIZE
1886	3/32" x 10'
1887	5/32" x 10'

TEFLON PACKING



- 1/16" x 24" Length

PART#	DESCRIPTION
2290	Graphite packing

OAKUM - CuT LENGTH



- Convenient, labour saving cut lengths
- Non-splitting
- Contains no tar
- Made to pack well, caulks tight
- Treated with a special compound so that it expands when wet
- Lead ladles, Lead pots, Joint runners and caulking tools are also available

PART#	DESCRIPTION
2899	1lb bag
2897	5lbs box

Sw IFT SET CEMENT



- Cement patching compound
- Sets in minutes
- For concrete & masonry repairs
- For floors, precast & drain rework
- For repairs up to 2" thick
- Clean up tools with water

PART#	DESCRIPTION
2893	2kg tub

PLUG TITE CEMENT



- Stops flow of water through breaks in concrete & masonry
- Works on basement walls, floor, pools etc.
- Fills cracks 3-5 minutes set-time
- Clean up tools with water

PART#	DESCRIPTION
2894	2kg tub

CHEMICAL & SHOP

CHEMICALS & SHOP SUPPLIES

PVC CEMENT wET/DRY



- One stop cement
- Low VOC
- All weather
- Fast set time 20 seconds
- NSF61, NSF14 approved
- Meets ASTM D2564

PART#	DESCRIPTION	CASE
506059	237ml BT can	24

SOLDER FLUX PASTE



- Self cleaning
- Noncorrosive
- Lead free
- Use on Copper, Iron, Steel
- Not recommended for Aluminum

PART#	DESCRIPTION	CASE
59110	4oz jar	24

WATER SOLUBLE PASTE FLUX



- AQUA PRO 2000
- Water soluble flux
- Non fuming and lead free
- Meets ASTM B813

PART#	DESCRIPTION	CASE
59115	4oz	24

PLUMBER'S PUTTY



- Does not harden
- Cream colour

PART#	DESCRIPTION	CASE
59100	14oz	24
59105	5lb tub	6

BRUSH IN CAN



- LYNCAR offers the popular brush in can with either a metal OR plastic jug.
- Available in two sizes 500ml or 1 litre containers
- Our brush offers the "Click It" feature a natural bristle adjustable brush that is leak proof, and the handle adjusts in the cap.

PART#	DESCRIPTION
78810	Click it brush w/ 500 ml metal can
78812	Click it brush w/ 1 litre plastic can
78814	Click it brush w/ 500 ml plastic can
4656	"Click it" brush ONLY

CHEMICALS & SHOP SUPPLIES

H

FLOW CLEAN DESCALER SOLUTION TANKLESS WATER HEATER CLEANER & KIT



- Cleaner for potable water systems
- Non corrosive, non toxic
- Biodegradable and zero VOC
- Dissolves water scale, lime, rust and other deposits
- In tankless water heaters, also in ice machines, boilers, chillers, exchangers etc.
- NSF approved

DESCALER KIT

- 350 GPH pump
- 2 pcs 60" rubber hoses
- 1 litre solution bucket with lid

PART#	DESCRIPTION	CASE
15150	32oz (1 litre) plastic jug	12
15151	4 litre jug	6
15152	Descaler kit	1

PIPE WRAP TAPE - PVC



- LYNCAR all weather pipe protection tape is a pure physical barrier that is moisture proof, inert and non-conducting. Whether the need is to protect overhead piping in industrial applications, exposed pipe anywhere, or direct burial piping. This tape gives a completely uniform coating all around.
- Tough PVC plastic tape with special high tack adhesives formulated to resist corrosion
- Easy to apply by hand with no special tools or equipment
- Positive protection against abrasion and corrosive action for steel pipe, fittings and electrical conduit systems
- Corrosion protection for metal piping systems above and below ground
- Corrosion protection for fittings and joints on mill coated pipe
- Corrosion protection of electrical conduct and fittings
- Resists corrosive action by salt water, soil acids, alkalies and salts
- Prevents dielectric corrosion between buried steel pipe and soil minerals
- Resists the effects of outdoor weathering and sunlight exposure
- High abrasion resistance
- Highly conformable over a wide temperature range
- Excellent insulating properties
- Resists commonly encountered chemicals and chemical vapors
- Protects against fungus and bacteria

The type printed on the actual tape as shown below.

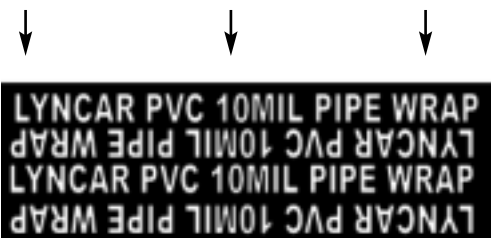

PART#	w IDTH	MILL	LENGTH	CASE
9051	1"	10	100'	48
9052	2"	10	100'	24
9054	4"	10	100'	12

CHEMICAL & SHOP

TAPES

DuCT TAPE



- Contractor grade quality
- 48mm x 55m
- Each roll retail packaged
- 24 rolls per case

PART#	DESCRIPTION
8518	Duct Tape

ELECTRICAL TAPE



- Contractor grade quality
- 3/4" x 60' Roll
- Each roll retail packaged, 10 rolls per sleeve
- CSA

PART#	DESCRIPTION
8520	Electrical Tape

ALuMINuM FOIL TAPE



- Contractor grade quality
- 48mm x 50m
- Each roll retail packaged
- 24 rolls per case

PART#	DESCRIPTION
8519	Aluminum Foil Tape

FILAMENT TAPE



- Fiberglass reinforced tape for general strapping and bundling applications.

PART#	DESCRIPTION
8510	12mm x 55m
8514	48mm x 55m

CHEMICALS & SHOP SUPPLIES

H

GREEN BLASTER DRAIN OPENER



- Drain opener
- Dry granular drain opener for clearing grease, hair and other organic matter from drains.
- Will not harm Chrome, Polished Brass or Plastic. Safe for Septic tanks
- 454 grams
- Product only available in English at this time

PART#	DESCRIPTION	CASE
59005	Professional strength	24

PLUMBER'S GLOOZIT



- Secure or resecure towel bars that are loose: apply to the threads of stripped screws
- Patch leaks in plastic, copper, steel and cast iron pipes
- Attach ceramic soap dishes to tile - no screws needed!
- Repair garden hoses
- Repair leaks in gutter, down pipe and seams on eavestroughing
- Cement plastic pipe together
- Attach decorations to mirror, attach mirrors to any wall, whether tile, wood, cement or gyprock
- 90 mil tube

PART#	DESCRIPTION
1711	Plumber's gloozit

EPOxy PuTTY, STIk-IT



- STIK-IT EPOXY PUTTY is a hand kneadable fast curing epoxy putty that mixes in one minute to provide permanent repairs to many surfaces including metals, wood, glass, concrete, ceramics and numerous plastics
- One hour after mixing, STIK-IT EPOXY PUTTY can be drilled, sawed, sanded, filed, tapped, machined or painted
- It comes in a handy "tootsie roll" form with the curing agent encapsulated in the contrasting colour base material
- Its remodeling clay-like consistency eliminates drips and runs, provides "no mess" application with no tools required for use
- STIK-IT EPOXY PUTTY is a general purpose epoxy putty.

PART#	SIZE
59070	2 oz.
59075	4 oz.

SOAPSTONE



- Temporary marking of welding & cutting lines
- Made of natural soapstone
- 144 pcs per box
- Flat 1/2" x 3/16" x 5"

PART#	DESCRIPTION
5190	Soapstone

CHEMICAL & SHOP

CHEMICALS & SHOP SUPPLIES

GLUE WASH HAND CLEANER



- "GLUE-WASH" solvent cement hand cleaner lotion is a nontoxic hand cleaner that safely removes ABS and PVC plastic solvent cements from skin

PART#	SIZE	CASE
506055	118 ml	24
506056	473 ml	12

LYNCAR CITRUS HAND CLEANER



- LYNCAR citrus HC contains the superior power of pure natural citrus oils
- Fresh citrus scent from real lemons, limes, and oranges is pleasant while cleaning up, yet it vanishes quickly and does not linger
- Contains no artificial fragrances and is readily biodegradable, non-toxic and petroleum solvent free.
- Natural citrus oils make LYNCAR Citrus HC a TOUGH, hard working hand cleaner that performs and hates grime, yet treats your hands with the care they deserve.
- Conditions your skin to help prevent drying and cracking

PART#	SIZE	CASE
59001	473 ml	12
59002	4 litre	6
59003	118 ml	24

PIPE MARKERS (BALL TYPE)



- LYNCAR'S paint markers are ideal for writing notes, job # or other information on pipe
- The ball point is a marker that liquid flows on to the point after pressing the top bubble
- Yellow & white stocked, other colours are available if requested

PART#	COLOUR	CARTON
608520w	White	12
608520y	Yellow	12

PIPE MARKERS (FELT TIP)



- LYNCAR'S paint markers are ideal for writing notes, job # or other information on pipe
- The fiber point is a marker that liquid flows on to the fiber tip after marker is shaken
- Available in packs of 12 yellow & white stocked, other colours are available if requested

PART#	COLOUR	CARTON
608522w	White	12
608522y	Yellow	12

PACKAGING & STORAGE PRODUCTS

CRAYON - wATERPROOF LuMBER



PART#	DESCRIPTION
5333	12 x yellow
5334	12 x red

BIN BOXES



- Corrugated bin boxes, no staples or tape needed
- Heavy duty boxes made from corrugated fiberboard, use them many times
- Fits standard 12" and 18" shelving units for storage of all your plumbing parts
- Many sizes available, call if we don't list your required size

PART#	DEPTH	SIZE	HEIGHT
BB212	12" deep	2"	4-1/2"
BB412	12" deep	4"	4-1/2"
BB812	12" deep	8"	4-1/2"
BB218	18" deep	2"	4-1/2"
BB418	18" deep	4"	4-1/2"
BB818	18" deep	8"	4-1/2"

BAG - ZIP LOCK PLASTIC



- LYNCAR can supply you with a wide selection of plastic bags for your inventory
- All bags are zip lock bags with a hanging hole and are 4 mil thick

PART#	wIDTH	LENGTH
BAG01	5"	8"
BAG04	4"	6"
BAG05	6"	9"
BAG21	4"	12"
BAG34	3"	4"
BAG35	3"	5"
BAG66	6"	6"
BAG69	6"	9"

TwINE - NyLON SEINE



- 275' of #18, 179 lb. test
- For plumb line, seine line, fishing line, chalk line, mason line and lead line
- To stop fraying when cut, apply flame to cut end (nylon melts)

PART#	DESCRIPTION
4115	Twine - nylon seine

ANTIFREEZE TESTER



- LYNCAR'S antifreeze tester (refractometers) is high quality, impact resistant and comes in its own carrying case
- Provides accurate direct reading in both fahrenheit and centigrade of glycol coolants

PART#	DESCRIPTION
996055	Antifreeze tester

HEAT TRANSFER FLUIDS

LyNCAR PG 95/5



- **LCPG 95/5** is a safe and odorless non-flammable premium heat transfer fluid with special corrosion inhibitors added. Contains 95% Propylene Glycol & 5% corrosion inhibitors (Dipotassium Hydrogen Phosphate and Inert Ingredients) Suitable for hydronic heating, and other process piping systems. Available in 4, 20 and 205 Litre containers.
- **ATTENTION**
Not for use with aluminum, galvanized or CPVC piping systems.

PART#	SIZE
506032	4 litre jug
506031	20 litre pail
506030	205 litre drum

LyNCAR PG PuRE



- **LCPG Pure** is a safe and odorless non-flammable premium antifreeze fluid. Contains 100 % Propylene Glycol. Suitable for Fire Sprinkler Systems. Conforms to the NFPA 13, 2007 edition. Colourless, odorless, available in 4, 20 and 205 Litre containers.
- **ATTENTION**
Not for use with aluminum, galvanized or CPVC piping systems

PART#	SIZE
506004	4 litre jug
506020	20 litre pail
506025	205 litre drum

RHOGARD ALUMINUM ANTIFREEZE



- Burst protection to -100°F
- Environmentally friendly
- Non-hazardous
- Hydronic and solar system heat transfer fluid
- Freeze and corrosion protection, contains multi-metal corrosion inhibitors

PART#	SIZE
506033	20kg pail

LyNCAR GL PRE-MIXED ANTIFREEZE



- **LCGL48** is a safe and odourless non flammable premium premixed antifreeze fluid for fire sprinkler systems
- Contains Glycerine Antifreeze 48% by volumed conforms to the 2010 edition of NFPA. Available in 4,20 and 205 litre containers

PART#	SIZE
50610448	4 litre jug
50612048	20 litre pail
50612548	205 litre drum

LyNCAR PG PRE-MIXED ANTIFREEZE



- **LCPG38** is a safe and odourless non flammable premium premixed antifreeze fluid for fire sprinkler systems
- Contains Propylene Glycol 38% by volumed conforms to the 2010 edition of NFPA. Available in 4,20 and 205 litre containers

PART#	SIZE
50600438	4 litre jug
50602038	20 litre pail
50602538	205 litre drum

FLEXIBLE RUBBER PIPE COUPLINGS

J



- LYNCAR'S TRUEFLEX Couplings
- Connects cast iron, plastic, steel, copper and tubular piping
- Manufactured to ASTM 1173 and CSA B602 Standards
- No glue, welding or soldering
- Compensate for misaligned pipe
- Tight seal every time
- Sizes from 1-1/4" to 8"
- cUPC approved

CI = Cast Iron Pipe	PL = Plastic Pipe	CLAY = Clay Pipe
----------------------------	--------------------------	-------------------------

PART#	DESCRIPTION	APPLICATION	CARTON QTY
FC1250	TrueFLEX cUPC 1-1/4"	1-1/4" CI, PL x 1-1/4" CI, PL	100
FC1514	TrueFLEX cUPC 1-1/2" x 1-1/4"	1-1/2" CI, PL x 1-1/4" CI, PL	100
FC1515	TrueFLEX cUPC 1-1/2"	1-1/2" CI, PL x 1-1/2" CI, PL	100
FC2000	TrueFLEX cUPC 2"	2" CI, PL x 2" CI, PL	100
FC2150	TrueFLEX cUPC 2" x 1-1/2"	2" CI, PL x 1-1/2" CI, PL	100
FC3000	TrueFLEX cUPC 3"	3" CI, PL x 3" CI, PL	80
FC3020	TrueFLEX cUPC 3" x 2"	3" CI, PL x 2" CI, PL	80
FC3150	TrueFLEX cUPC 3" x 1-1/2"	3" CI, PL x 1-1/2" CI, PL	80
FC4000	TrueFLEX cUPC 4"	4" CI, PL x 4" CI, PL	60
FC4015	TrueFLEX cUPC 4" x 1-1/2"	4" CI, PL x 1-1/2" CI, PL	60
FC4020	TrueFLEX cUPC 4" x 2"	4" CI, PL x 2" CI, PL	60
FC4030	TrueFLEX cUPC 4" x 3"	4" CI, PL x 3" CI, PL	60
FC5000	TrueFLEX cUPC 5"	4" CLAY x 4" CLAY	30
FC5030	TrueFLEX cUPC 5" x 3"	4" CLAY x 3" CI, PL	30
FC5040	TrueFLEX cUPC 5" x 4"	4" CLAY x 4" CI, PL	30
FC6000	TrueFLEX cUPC 6"	6" CI, PL x 6" CI, PL	20
FC6030	TrueFLEX cUPC 6" x 3"	6" CI, PL x 3" CI, PL	20
FC6040	TrueFLEX cUPC 6" x 4"	6" CI, PL x 4" CI, PL	20
FC6050	TrueFLEX cUPC 6" x 5"	6" CI, PL x 4" CLAY	20
FC8000	TrueFLEX cUPC 8"	8" CI, PL x 8" CI, PL	10
FC8040	TrueFLEX cUPC 8" x 4"	8" CI, PL x 4" CI, PL	10
FC8060	TrueFLEX cUPC 8" x 6"	8" CI, PL x 6" CI, PL	10

SPECIALTIES

PROSEAL TRANSITION COUPLINGS



- LYNCAR'S PROSEAL transition couplings
- Creates rigid pipe connections
- Connects cast iron, plastic, steel, copper and tubular
- Each clamp is marked with size and use
- Meets ASTM C1460-2008 and CSA B602-05
- cJPC approved

CAST IRON, PLASTIC OR STEEL TO TUBULAR

PART#	DESCRIPTION
PC02150	1-1/2" CI, PL. or ST. to 1-1/2" tubular
PC02215	2" CI, PL. or ST. to 1-1/2" tubular
PC02155	1-1/2" tubular to 1-1/2" tubular

COPPER TO TUBULAR

PART#	DESCRIPTION
PC10150	1-1/2" copper to 1-1/2" tubular
PC10215	2" copper to 1-1/2" tubular

CAST IRON, PLASTIC STEEL OR STEEL TO COPPER

PART#	DESCRIPTION
PC011125	1-1/2" CI, PL. or ST. to 1-1/4" copper or 1" PL.
PC01150	1-1/2" CI, PL. or ST. to 1-1/2" copper or 1 1/4" PL.
PC012125	2" CI, PL. or ST. to 1-1/4" copper or 1" PL.
PC01215	2" CI, PL. or ST. to 1-1/2" copper or 1 1/4" PL.
PC0122	2" CI, PL. or ST. to 2" copper
PC01315	3" CI to 1-1/2" copper or 1-1/4" PL.
PC0132	3" CI to 2" copper
PC0133	3" CI to 3" copper
PC0143	4" CI to 3" copper
PC0144	4" CI to 4" copper

CAST IRON TO PLASTIC STEEL OR EXTRA HEAVY CAST IRON

PART#	DESCRIPTION
PC00150	1-1/2" CI, PL. or ST. to 1-1/2" CI, PL. or ST.
PC0022	2" CI, PL. or ST. to 2" CI, PL. or ST.
PC00215	2" CI, PL. or ST. to 1-1/2" CI, PL. or ST.
PC0033	3" CI to 3" PL, ST, or XH CI.
PC0043	4" CI to 3" PL, ST, or XH CI.
PC0044	4" CI to 4" PL, ST, or XH CI.

CAST IRON TO CAST IRON, PLASTIC OR STEEL

PART#	DESCRIPTION
PC04320	3" CI to 2" CI, PL or ST.
PC04420	4" CI to 3" CI, PL or ST.
PC04430	4" CI to 3" CI

COPPER TO COPPER

PART#	DESCRIPTION
PC03150	1-1/2" copper to 1-1/2" copper or 1-1/4" PL.
PC0322	2" copper to 2" copper
PC03215	2" copper to 1-1/2" copper or 1-1/4" PL.
PC0333	3" copper to 3" copper

DRAIN & TUBULAR REPAIR CONNECTORS

DRAIN & TRAP CONNECTORS



- 1 per bag packaged
- Grey in colour
- Stainless Steel clamps
- For drains & tubular application

PART#	DESCRIPTION
FC150DT	1-1/4" or 1-1/2" tubular traps to all 1-1/4" - 1-1/2" drain piping
FC215DT	1-1/4" or 1-1/2" tubular traps to all 1-1/4" or 2" drain piping (not copper)

DRAIN & TRAP CONNECTORS



- 1 per bag packaged
- Grey in colour
- Stainless steel clamps
- For drains & tubular application

PART#	DESCRIPTION
FC150TC	1-1/4" or 1-1/2" drain piping
FC100PC	1" plastic - 1-1/4" plastic/copper

DRAIN & TRAP CONNECTORS



- Fits 1-1/2" or 2" standpipes
- 1 per bag packaged
- Grey in colour
- Stainless steel clamps
- For drains, tubular and washing machine hose application

PART#	DESCRIPTION
FCHG1	2" or 1-1/2" standpipe to 1" through 1-7/16" washer hose

EASY TEE



- Make 90 degree connections easily
- Flexible PVC material
- Ideal replacement or repair fittings
- Stainless steel hose clamp
- cUPC approved



PART#	DESCRIPTION
FCY150	Easy PVC tee 1-1/2"
FCY200	Easy PVC tee 2"
FCY300	Easy PVC tee 3"
FCY400	Easy PVC tee 4"

EASY ELBOW



- Make 90 degree connections easily
- Flexible PVC material
- Ideal replacement or repair fittings
- Stainless steel hose clamp
- cUPC approved



PART#	DESCRIPTION
FCE150	Easy PVC elbow 1-1/2"
FCE200	Easy PVC elbow 2"
FCE300	Easy PVC elbow 3"
FCE400	Easy PVC elbow 4"

SPECIALTIES

NO-HUB COUPLING / MJ COUPLING



Size 1-1/2" Thru 4"

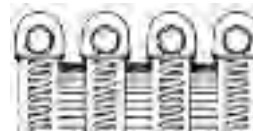

Size 5", 6" & 8"

- Clamp & shield all AISI 300 series stainless steel, no-hub gasket is neoprene
- CSA & ULC approved **CAN / ULC-S102 approval for "Surface Burning Characteristics of No Hub Coupling"** This is in addition to our CSA listing.

PART#	SIZE
64102	1-1/2" x 2"
64103	2" x 3"
64105	3" x 4"
64106	1-1/2" x 1-1/2"
64107	2" x 2"
64108	3" x 3"
64109	4" x 4"
64110	5" x 5"
64111	6" x 6"
64112	8" x 8"

SPECIALTIES

TRUE-FLEX SOCKET COUPLINGS



- LYNCAR'S TRUE-FLEX plastic to socket couplings
- Repair or alter plastic pipe joints. Fits over plastic pipe & fittings
- Hose clamp connections
- Up to 4"

PART#	IPS
FC59150	Socket to pipe coupling 1-1/2"
FC59220	Socket to pipe coupling 2"
FC59330	Socket to pipe coupling 3"
FC59440	Socket to pipe coupling 4"
FC60150	Socket to socket coupling 1-1/2"
FC60220	Socket to socket coupling 2"
FC60330	Socket to socket coupling 3"
FC60440	Socket to socket coupling 4"

TUBULAR REPAIR TRAP



- PVC repair trap for 1-1/4" or 1-1/2" drains
- Easy to repair and replace plastic or metal traps
- Simply clamp on

PART#	DESCRIPTION
FC150FT	PVC drain trap

SPECIALTIES

NO-HUB TORQUE WRENCH



- Measures torque when turned in a clockwise direction & ratchets when turned counterclockwise
- When the brand screw is tightened to the correct torque, the wrench ratchets so the handle will continue to turn but the drive socket will not
- Chrome vanadium socket for 5/16" Hex Head Screw
- 6" Long, Torques to 60 inch lbs. with retractable reversing lever

PART# DESCRIPTION

7020 No-hub torque wrench

HOSE CLAMPS



- Highest grade 1/2" bandwidth
- 100% stainless steel, 5/16" Hex head screw
- Highly corrosion resistant for marine or underground use
- 63K series, 300 series stainless steel band and housing, with a 302 grade stainless steel, slotted hex head screw
- All stainless steel marine or underground

PART#	BEST FITS	HOSE ID	OD SIZE RANGE	PART#	BEST FITS	HOSE ID	OD SIZE RANGE
63006	3/8"		7/16"-25/32"	63044	2-3/4"		2-51/6"-3-1/4"
63008	3/8"		1/2"-29/32"	63048	3"		2-9/16"-3-1/2"
63010	5/8"		9/16"-1-1/16"	63052	3-1/4"		2-13/16"-3-3/4"
63012	3/4"		1-1/16"-1-1/4"	63056	3-1/2"		3-1/6"-4"
63016	1"		13/16"-1-1/2"	63064	4"		3-9/16"-4-1/2"
63020	1-1/4"		13/16"-1-3/4"	63072	4-1/4"		4-1/8"-5"
63024	1-1/2"		1-1/16"-2"	63080	4-1/2"		4-5/8"-5-1/2"
63028	1-3/4"		1-5/16"-2-1/4"	63088	5"		5-1/8"-6"
63032	2"		1-9/16"-2-1/2"	63096	5-1/2"		5-5/8"-6-1/2"
63036	2-1/4"		1-13/16"-2-3/4"	63104	6"		6-1/8"-7"
63040	2-1/2"		2-1/16"-3"				

MINIATURE HOSE CLAMP



- 37K SERIES 3/8" bandwidth
- 1/4" Hex head screw
- Marine grade, 100% stainless steel
- Screw - 305 stainless, band 300 series stainless, housing 300 series stainless

Part# BAND WIDTH SIZE RANGE

37004	5/16"	7/32"-5/8"
37006	3/8"	7/16"-25/32"
37008	3/8"	1/2"-29/32"
37010	1/2"	1/2"-1"

TEST CAP & CLEAN OUT

**HIGHEST GRADE
100% STAINLESS
STEEL
1/4" HEX HEAD
SCREW**



- Fits plastic and hubless cast iron DWV pipe
- Made from high quality rubber with a stainless steel clamp
- Rubber has cross rib for extra strength and inside knurling grips pipe



PART # SIZE

4417	1-1/2"
4418	2"
4419	3"
4422	4"
4840	5"
4841	6"

STAINLESS STEEL REPAIR CLAMPS

ONE BOLT TYPE 3" LENGTH



- Stainless steel body with malleable iron lugs, neoprene gasket, carriage bolt & nuts

PART#	IPS
2660	1/2"
2661	3/4"
2662	1"
2663	1-1/4"
2664	1-1/2"
2665	2"
2666	2-1/2"
2667	3"
2669	4"

TWO BOLT TYPE 6" LENGTH



- Stainless steel body with malleable iron lugs, neoprene gasket, carriage bolt & nuts

PART#	IPS
2674	1/2"
2675	3/4"
2676	1"
2677	1-1/4"
2678	1-1/2"
2679	2"
2680	2-1/2"
2681	3"
2683	4"

HINGE TYPE-ECONOMICAL



- Plated steel, supplied with gasket that provides temporary repairs for split pipe

PART#	IPS
1680	1/2"
1681	3/4"
1682	1"
1683	1-1/4"
1684	1-1/2"
1685	2"

LYNCAR'S TRUEHUGGER REPAIR CLAMPS



- Professional temporary repairs for split pipe, TrueHUGGER is a reuseable repair clamp
 - Similar to a MJ Coupling, split rubber core easily wraps around damaged pipe
 - Open to allow wrap around pipe
 - Twin stainless gear clamps and stainless steel backer housing with split neoprene rubber gasket

PART#	IPS
2700	1/2"
2701	3/4"
2702	1"
2703	1-1/4"
2704	1-1/2"
2705	2"

PLUMBING VALVES

SWING CHECK VALVE - IPS



- Brass swing check valve
- 200 WOG
- IPS threads

PART#	DESCRIPTION
81012	1/2"
81034	3/4"
81100	1"

VALVE - SWING CHECK CXC



- Brass swing check valve
- 200 WOG
- Sweat ends

PART#	DESCRIPTION
82012	1/2"
82034	3/4"

SEDIMENT FAUCET



- Brass sediment faucet male hose outlet
- CSA approved

FOR PEX EQUIVILANT SEE PAGE G-14

PART#	DESCRIPTION
89012	1/2", red handle
89012B	1/2", blue handle
89034	3/4", red handle

BOILER DRAIN VALVE



- Brass boiler drain valve
- IPS threads
- CSA approved

FOR PEX EQUIVILANT SEE PAGE G-14

PART#	DESCRIPTION
90112	1/2"
90034	3/4"

FOOT VALVE



- Chrome brass foot valve

PART#	DESCRIPTION
804012	1/2"
804034	3/4"
804100	1"
804114	1-1/4"
804115	1-1/2"
804200	2"

VALVE - HOSE BIBB



- Brass body
- Male IPS threads
- 3/4" garden hose outlet

PART#	DESCRIPTION
92012	1/2"
92034	3/4"

PLUMBING VALVES - QUARTER TURN

HOSE BIBB / BOILER DRAIN Q/TURN VALVE



- 1/4 turn brass valve
- Red handle
- Male hose outlet
- CSA approved

PART#	DESCRIPTION
97012	1/2" male or 1/2" C x C x 3/4" MHT
97034	3/4" male x 3/4" MHT

SEDIMENT FAUCET VALVE, Q/TURN



- 1/4 turn brass valve
- Red handle
- Male hose outlet
- cUPC approved

PART#	DESCRIPTION
98012	1/2" male or 1/2" C x C x 3/4" MHT, red handle
98012B	1/2" male or 1/2" C x C x 3/4" MHT, blue handle
98034	3/4" male x 3/4" MHT, red handle

FOR PEX EQUIVILANT SEE PAGE G-14

BOILER DRAIN HOSE BIBB VALVE Q/TURN



- 1/4 turn brass valve
- Red handle
- Male hose outlet
- CSA approved

PART#	DESCRIPTION
99012	1/2" male x 3/4" MHT
99034	3/4" male x 3/4" MHT

SPECIALTIES

SPECIALTIES

HOSE FAUCET TIMER



- Orbit 2-hour hose faucet controller, easy to install to any outdoor hose faucet
- Battery-operated (three AA batteries Not Included; 18 VAC, 60 Hz) automatic water controller & valve combination
- Standard 3/4" and 3/4" BSP (international) hose thread connections
- Water-resistant design
- Manual on feature for quick temporary watering
- High quality diaphragm valve
- Flexible timer settings for the water to come on every: 2 hours, 4 hours, 8 hours, 12 hours, daily, every second day, every third day, every fourth day or once a week

PART# DESCRIPTION

91600 Hose faucet timer

VACUUM BREAKER



- Brass vacuum breaker
- 3/4 FHT x 3/4 MHT
- Vandal proof breakoff screw
- Box packed
- CSA approved



PART# DESCRIPTION

2139 Vacuum breaker

FROST FREE FAUCET



- Chrome brass
- 1/2" IPS
- CSA approved



PART# SIZE

806008 8"
806010 10"
806012 12"
806014 14"

FAUCET - FROST FREE W/ BUILT IN VACUUM BREAKER



- Chrome body and tube
- Garden hose outlet
- Built in breaker, self draining
- Complete with plastic insert
- 1/2" MPT or 1/2" PEX ends
- CSA approved



PART# PEX PART# SIZE

806508 **806508P** 8"
806510 **806510P** 10"
806512 **806512P** 12"
806514 **806514P** 14"

SPECIALTIES

WASHER - GARDEN HOSE



- Fits 3/4" FHT

PART#	DESCRIPTION
2224	Washer - garden hose

WASHER - CONE FILTER



- Fits 3/4" FHT

PART#	DESCRIPTION
2244	Washer cone filter

HOSE CAP



- Brass
- Light duty
- With gasket

PART#	DESCRIPTION
2152	Hose cap

BRASS HEX HOSE CAP & CHAIN



- 3/4 hose thread
- Hose cap-hex, brass
- Heavy duty
- With chain
- With gasket

PART#	DESCRIPTION
2154	Hex hose cap and chain

GARDEN HOSE SHUTOFF VALVE



- Plastic, positive ball shutoff
- 3/4" MHT x 3/4" FHT

PART#	DESCRIPTION
2157	Straight shut off
2158	Wye shut off

SHUT OFF BRASS, WYE



- 3/4" MHT x 3/4" MHT x 3/4" FHT
- With shut offs
- Brass

PART#	DESCRIPTION
2160	Brass wye with shutoff

PLUMBING BALL VALVES



BALL VALVE - FULL PORT IPS



- Premium quality valve
- Full port, brass body, teflon seat 600WOG
- IPS threads
- CSA, UL approved

PART#	DESCRIPTION	PART#	DESCRIPTION
806912	1/2"	806914	1-1/4"
806934	3/4"	806915	1-1/2"
806910	1"	806920	2"

VALVE - BALL 600 WOG FULL PORT CxC



- Premium quality valve
- Full port
- Brass body, teflon seat, 600 WOG
- Sweat ends
- CSA approved

PART#	DESCRIPTION	PART#	DESCRIPTION
807712	1/2"	3347CXP	1/2" copper x PEX see page G-13
807734	3/4"	3347CXP	3/4" copper x PEX see page G-13
807710	1"		

BALL VALVE - CxC W/ DRAIN



- Good quality utility valve
- Full port, sweat ends
- Brass body, teflon seat, 600 WOG

PART#	SIZE	PART#	DESCRIPTION
806712	1/2"	69739	1/2" PUSHFIT see page G-4
806734	3/4"	3347D	1/2" PEX see page G-13
806710	1"	3348D	3/4" PEX see page G-13

BALL VALVE - BARB x SWEAT



- Premium quality valve
- Barb x sweat
- 600 WOG body

PART#	DESCRIPTION	PART#	DESCRIPTION
806612	1/2" barb x sweat	3348	3/4" PEX see page G-13
806634	3/4" barb x sweat	69728	1/2" PUSHFIT see page G-4
806610	1" barb x sweat	69729	3/4" PUSHFIT see page G-3
3347	1/2" PEX see page G-13	69730	1" PUSHFIT see page G-4

FOR PEX EQUIVILANT SEE PAGE G-13

PLUMBING VALVES & SHUT-OFF VALVES

J

LOCKING BALL VALVE FOR GAS



- Full Port
- 600 WOG
- Lockable lever handle
- CAN 3.16 approved
- FM, cUL, CSA approved



PART#	SIZE
-------	------

807812	1/2"
807834	3/4"
807810	1"
807814	1-1/4"
807815	1-1/2"
807820	2"

VALVE - BALL COMPRESSION



- Compression Connections
- Brass Body, Teflon Seat, 600 WOG, Full port
- Side Drain

PART#	SIZE
-------	------

806812	1/2"
806834	3/4"
806810	1"

VALVE - FEMALE x MALE PIPE



Do not use with liquified petroleum, natural gas, oxygen or similar explosive or combustible medium.

PART#	FPT	MPT
-------	-----	-----

7900	1/8"	1/8"
7901	1/4"	1/4"
7902	3/8"	3/8"

VALVE - MALE x MALE PIPE



Do not use with liquified petroleum, natural gas, oxygen or similar explosive or combustible medium.

PART#	MPT	MPT
-------	-----	-----

7903	1/8"	1/8"
7904	1/4"	1/4"
7905	3/8"	3/8"

VALVE - FEMALE x FEMALE PIPE



Do not use with liquified petroleum, natural gas, oxygen or similar explosive or combustible medium.

PART#	FPT	FPT
-------	-----	-----

7906	1/8"	1/8"
7907	1/4"	1/4"
7908	3/8"	3/8"

SPECIALTIES

SHUT OFF VALVES

VALVE - COMPRESSION



Do not use with liquified petroleum, natural gas, oxygen or similar explosive or combustible medium

PART#	MPT
7910	1/8"
7914	1/4"
7916	3/8"
7918	1/2"
7919	1/2"

VALVE - T-HANDLE DRAIN



Do not use with liquified petroleum, natural gas, oxygen or similar explosive or combustible medium.

PART#	MPT
7947	1/8"
7948	1/4"
7949	3/8"

COMPRESSION - 74 SERIES x MIP ANGLE VALVE



PART#	DESCRIPTION
7-74542	1/4" x 1/8"

COMPRESSION - 75 SERIES x MIP VALVE



PART#	DESCRIPTION
7-75042	1/4" x 1/8"

COMPRESSION - 78 SERIES NEEDLE VALVE



PART#	DESCRIPTION
7-7834	1/4"
7-7836	1/8"

SPECIALTIES

RADIATOR AIR VALVE WHEEL KEY



- Wood handle threaded
- Plated body
- 24 pcs per box

PART#	DESCRIPTION
607	Valve complete
608	Handle only
605LK	Radiator Valve only

RADIATOR AIR VALVE COIN VENT STYLE



PART#	DESCRIPTION
605	Valve complete
606	Handle only

RADIATOR HANDLE 4 IN 1



- 4 in one handle sockets
- Fits 4 stem sizes
- One per bag

PART#	DESCRIPTION
4951	4 in one handle sockets

PIGTAIL SIPHONS



- 1/4" IPS steel
- Complies with ASTM B-53
- 600 PSI 750°F

PART#	DESCRIPTION
1459	Straight
1460	Angle

SPECIALTIES

GAUGE - LIQUID FILLED PRESSURE



- For use where gauge is exposed to corrosion, vibration, pulsation or metal fatigue such as pumps, compressors, hydraulic equipment and machine tools.
- Dual scale dial (KPA and PSI)
- 2-1/2" face in various pressure ranges
- 4" Face – 0 to 300 PSI
- 1/4" bottom mount brass connection

PART#	TYPE	PSI	PART#	TYPE	PSI
1772	2-1/2" dial face	0-30#	1773-4	4" dial face	0-60#
1773	2-1/2" dial face	0-60#	1774-4	4" dial face	0-100#
1774	2-1/2" dial face	0-100#	1776-4	4" dial face	0-200#
1776	2-1/2" dial face	0-200#	1777-4	4" dial face	0-300#
1777	2-1/2" dial face	0-300#	1779-4	4" dial face	0-600#

GAUGE - PRESSURE



- Dual scale dial (KPA & PSI)
- Steel case
- 1/4" MPT brass connection
- Plastic face
- 2-1/2" & 4" face sizes
- 1/4" bottom mount brass connection

PART#	TYPE	PSI	PART#	TYPE	PSI
1739	2-1/2" dial face	30#	1764	4" dial face	60#
1740	2-1/2" dial face	60#	1765	4" dial face	100#
1741	2-1/2" dial face	100#	1766	4" dial face	160#
1742	2-1/2" dial face	160#	1767	4" dial face	200#
1743	2-1/2" dial face	200#	1768	4" dial face	300#
1744	2-1/2" dial face	300#			

GAUGE - COMPOUND & VACUUM



- 2-1/2" diameter
- 1/4" MPT brass connection
- Steel case
- 1/4" bottom mount brass connection

PART#	DESCRIPTION
1422	30" vacuum

GAUGE - FIRE PROTECTION SPRINKLER



- 3-1/2" diameter
- 1/4" MPT brass connection
- 1/4" bottom mount brass connection
- FM approved
- UL and ULC listed

PART#	SYSTEM	PSI
307600	Wet	0-300#
307605	Dry	0-250#
307601	Combo	0-300#

FOR PLUMBING TEST GAUGES SEE PAGE L-18

GAUGES

BOILER GAUGES PRESSURE



- Specially constructed for use on hot water heater boilers
- Gives accurate indication of temperature and pressure
- Dual scale: 40° - 260° F, 20° - 120° C
- 2-3/4" diameter
- 1/2" MPT brass connection
- Steel case
- Glass face

PART#	PSI	TEMP	CONNECTION & ELEMENT LENGTH
1451	0-50#	60° - 260°	2-3/4" bottom mount
1452	0-50#	60° - 260°	2-3/4" back mount

BOILER GAUGES TEMPERATURE



- Specially constructed for use on hot water heater boilers
- Gives accurate indication of temperature and pressure
- Dual scale: 60° - 320° F, 16° - 160°C, 2-3/4" diameter
- 1/4" MPT Brass connection
- Centre backmount
- Polycarbonate face

PART#	PSI	TEMP	CONNECTION & ELEMENT LENGTH
1435	0-75#	60° - 320°	2-1/2"
1437	0-75#	60° - 320°	3-1/2"
1435BTM	0-75#	60° - 320°	2-1/2" bottom mount

THERMOMETER - DIAL TYPE



- Economical, back mount
- Dual scale: 40°-250°F, 0-120°C, accuracy to 1°, 5° Increments, 2-1/2" face
- Brass wells, recalibration feature,
- Choice of adapters
- Thermometer can be removed from adapter for easy installation

PART#	DESCRIPTION
1449	1/2" MPT CBM connection
1449C	MPT CBM well only
1450	3/4" CWT Solder connection
1450W	CWT Solder well only



THERMOMETER - HOT WATER



- Dual scale: 40°-280°F, 0°-130°C
- 1/2" Brass MPT connection

PART#	STYLE
1444	Angle
1445	Straight

SPECIALTIES

THERMOMETER - DIAL TYPE



- Dial type
- Back mount
- Dual scale: 32°-250°F, 0°-120°C
- 3-1/2" diameter
- 1/2" MPT brass connection
- 2-1/2" brass element (beyond MPT)
- Corrosion resistant steel case

PART#	DESCRIPTION
1455	1/2" MPT CBM connection

RED RUBBER GASKETS



- LYNCAR's red rubber gaskets and rolls
- All gaskets are packaged in 10's, wrapped and labeled
- Choose either ring or full face types
- We also offer square gaskets or rolls if you or your customer prefers to make your own

FULL-FACE PART#	RING PART#	SIZE
80201	80200	2"
80213	80212	2-1/2"
80301	80300	3"
80401	80400	4"
80601	80600	6"
80801	80800	8"

RED RUBBER SHEET



PART# 12551



PART# 12550

- 1/8" rubber sheet to make your own gasket

PART#	DESCRIPTION
12550	Make a gasket sheet 6" x 6" x 1/8"
12551	Roll of red rubber 3 ft x 15 ft x 1/8"

FLANGE REPAIR KIT



- All kits come with two ring gaskets, bolts and nuts
- Packaged, ready to install

PART#	RING GASKET	SIZE OF BOLTS
80201K	Kit 2"	5/8" x 2-1/2" x 4 pcs
80301K	Kit 3"	5/8" x 2-3/4" x 4 pcs
80401K	Kit 4"	5/8" x 3" x 8 pcs
80601K	Kit 6"	3/4" x 3-1/2" x 8 pcs

SPECIALTIES

POTABLE WATER & HYDRONIC EXPANSION TANKS



- Welded Steel construction
- Rugged flexible diaphragm
- Pre-charged at 12 PSIG
- Compact design saves energy and space
- Glycol compatible
- Maximum working pressure: 150 PSIG
- Ideal for peak use systems such as car washes, processing plants, hotels/motels, commercial laundries Pressure relief valves relieve excess pressure in cold water storage tanks and water supply lines

PART#	DESCRIPTION
80902A	Potable water 2.0 gallon
80905A	Potable water 4.4 gallon
80913A	Potable water 10.3 gallon

PRESSURE RELIEF VALVE



- Bronze pressure only relief valves for supply lines and cold water storage tanks
- 50 to 160 PSIG
- 125 PSIG standard set pressure
- Adjustable by-pass relief valve available
- Protects equipment by allowing excess volume to be discharged to storage tank or back to the source

PART#	DESCRIPTION
80530	1/2"
80530A	3/4"

SUMP PUMP CHECK VALVE



- ABS material, rubber coupling ends with stainless steel clamps
- Fast and easy installation
- Eliminates backflow

PART#	DESCRIPTION
29114	1-1/2"
29112	2"

SILENCER SUMP PUMP CHECK VALVE



- ABS material, rubber coupling ends with stainless steel clamps
- A silencer check valve eliminates hammering noises with pump cycling
- Vertical or horizontal

PART#	DESCRIPTION
29121	1-1/2"
29122	2"

SPECIALTIES

LYNCAR'S TRUEARRESTOR WATER HAMMER ARRESTOR

J

1/2" MIP



- Stops banging and thumping in water lines
- Can be installed at any angle
- "AA" size
- Carded for display
- cUPC approved
- ASSE 1010 approved



MALE SWEAT



- Stops banging and thumping in water lines
- Can be installed at any angle
- "AA" size
- Carded for display
- cUPC approved
- ASSE 1010 approved



PART#	DESCRIPTION
8030001	1/2" MIP

PART#	DESCRIPTION
8030002	1/2" male sweat
8030003	3/4" male sweat

PEX TEE



- Stops banging and thumping in water lines
- Can be installed at any angle
- "AA" size
- Carded for display
- cUPC approved
- ASSE 1010 approved



SJ TEE



- Stops banging and thumping in water lines
- Can be installed at any angle
- "AA" size
- Carded for display
- cUPC approved
- ASSE 1010 approved



PART#	DESCRIPTION
8030007	1/2" PEX tee

PART#	DESCRIPTION
8030013	1/2" OD

OD FEMALE COMP X OD COMP



- Stops banging and thumping in water lines
- Can be installed at any place
- "AA" size
- Carded for display
- cUPC approved
- ASSE 1010 approved



TEE



- Stops banging and thumping in water lines
- Can be installed at any place
- "AA" size
- Carded for display
- cUPC approved
- ASSE 1010 approved



PART#	DESCRIPTION
8030014	3/8" OD female comp x 3/8 OD comp.

PART#	DESCRIPTION
8030009	3/8" OD compression tee
8030010	1/2" OD compression tee

PEX, STRAIGHT



- Stops banging and thumping in water lines
- Can be installed at any place
- "AA" size
- Carded for display
- cUPC approved
- ASSE 1010 approved



LAUNDRY MINI-RESTER



- Stops banging and thumping in water lines
- Can be installed at any angle
- "AA" size
- Carded for display
- cUPC approved
- ASSE 1010 approved



PART#	DESCRIPTION
8030016	1/2" PEX

PART#	DESCRIPTION
8030012	3/4" MHT x 3/4" swivel FHT

SPECIALTIES

BRASS HOSE TO PIPE ADAPTERS

EVAPORATIVE COOLER ADAPTER



MHT	= MALE HOSE THREADS
MPT	= MALE PIPE THREADS
FHT	= FEMALE HOSE THREADS
FGHT	= FEMALE GARDEN HOSE THREAD
FPT	= FEMALE PIPE THREADS

PART#	MPT	FPT	FPT SIDE TAP
7-3098	1/2"	1/2"	1/8"
7-30912	3/4"	3/4"	1/8"

HOSE WYE



PART#	MHT	MHT	FHT
2156	3/4"	3/4"	3/4"

ADAPTER MALE HOSE - MALE PIPE



Tapped 1/2" FPT inside 3/4" MPT.

PART#	MHT	MPT
2140	3/4"	3/4"

ADAPTER MALE HOSE - MALE PIPE



The 1/2" copper connection is inside the 1/2" MPT.

PART#	MHT	MPT	FEMALE COPPER SWEAT
2143	3/4"	1/2"	1/2"

FEMALE SWIVEL ADAPTER



PART#	FHT SWIVEL	FPT
2141	3/4"	1/2"
2142	3/4"	3/4"

ADAPTER FEMALE HOSE - MALE PIPE



Tapped 1/2" FPT inside 3/4" MPT

PART#	FHT	MPT	FIP
2150	3/4"	3/4"	1/2"

ADAPTER FEMALE HOSE - FEMALE PIPE



PART#	FHT	FPT
2147	3/4"	1/2"
2148	3/4"	3/4"

BRASS HOSE TO PIPE ADAPTERS

ADAPTER FEMALE HOSE - MALE PIPE



- The 1/2" copper connection is inside the 1/2" MPT

PART#	FHT	MPT	FEMALE COPPER SWEAT
2144	3/4"	1/2"	1/2"

ADAPTER MALE HOSE (BOTH ENDS) - FEMALE PIPE



One end tapped 1/2" FPT

PART#	MHT	MHT	FPT
2151	3/4"	3/4"	1/2"

EVAPORATIVE COOLER DRAIN



- With washer & locknut

PART#	MHT	FPT
2145	3/4"	1/2"

ADAPTER MALE HOSE - FEMALE PIPE



PART#	MHT	FPT
2146	3/4"	3/4"

ADAPTER, 3/4" FHT x 3/4" FHT



PART#	FHT	FHT
2149	3/4"	3/4"

ADAPTER DUAL SWIVEL - FEMALE HOSE



PART#	FHT	FHT
2153	3/4"	3/4"

ACCESS DOORS - METAL

GENERAL PURPOSE
ACCESS PANELS

Non-Rated Flush Door For Drywall, Masonry, & Tile



Wall Opening: Allow additional 1/8"
- 3/8" for rough wall opening.

- Door: 14 gauge steel (0.078 inch thick)
- Frame: 16 gauge steel (0.060 inch thick), 1" Wide
- Hinge: Pin hinge
- Latch: Screwdriver operated cam latch
- Finish: Phosphate dipped with grey prime coat
- Packaging: one panel per carton

PART#	SIZE	CAM LOCKS
350606	6" x 6"	1
350808	8" x 8"	1
351010	10" x 10"	1
351212	12" x 12"	1
351414	14" x 14"	1
351616	16" x 16"	1
351818	18" x 18"	1
352424	24" x 24"	5
353030	30" x 30"	5
353636	36" x 36"	5

FIRE RATED ALL PURPOSE INSULATED ACCESS DOOR



- **Door:** 20 gauge cold rolled steel
- **Frame:** 16 gauge cold rolled steel with 1" flange
- **Hinge:** Flush continuous piano hinge
- **Latch:** Knurled knob/key operated latch bolt
- **Finish:** Phosphate dipped and prime coated
- **Insulation:** 2" thick fire rated mineral fiber
- UL listed "B" label for 1-1/2 hours in walls (maximum temperature rise to 250° F in 30 min.)
- Warnock-Hersey listed for 3 hours in ceilings
- Call LYNCAR for sizes not listed



PART#	SIZE
361212	12" x 12"
361818	18" x 18"
362424	24" x 24"

FIRE RATED ALL PURPOSE UNINSULATED ACCESS DOOR



- **Door:** 14-gauge cold rolled steel
- **Frame:** 16-gauge cold rolled Steel with 1" flange
- **Hinge:** Flush continuous piano hinge
- **Latch:** Knurled knob/key operated latch bolt
- **Finish:** Phosphate dipped and prime coated
- **Insulation:** None
- UL listed for 1-1/2 hours in walls only
- No temperature rise rating.No ceiling rating
- Call LYNCAR for sizes not listed



PART#	SIZE
370808	8" x 8"
371212	12" x 12"
371818	18" x 18"
372424	24" x 24"

SPECIALTIES

ACCESS DOORS - PLASTIC

ACCESS PANEL - ABS PLASTIC



- Made from UV stabilized high-impact ABS, the textured panel surface can be painted, wallpapered or tiled to match any décor and are approved for indoor or outdoor use
- Panels fasten on all four sides to prevent sagging
- Panels can be flush or surface mounted

PART#	SIZE
300808	8" x 8"
300609	6" x 9"
301414	14" x 14"

ACCESS PANEL, PLASTIC, SNAP



- No framing required
- Fast Installation
- Paint or wallpaper after installation
- Easy to cover up plumbing valves or electrical cables etc.
- Retail packaged

PART#	SIZE
310808	8" x 8"
311212	12" x 12"

ACCESS PANEL - FLUIDMASTER



- FLUIDMASTER, no framing access panel
- Fast installation
- Easy to cover up plumbing valves or electrical cables etc.

PART#	DESCRIPTION
FM0808	8" x 8"
FM1414	14" x 14"

WATER HEATER PARTS

REPLACEMENT CORDS

Disposer / Furnaces / Timers/ Etc.



- LYNCAR replacement cords for disposer, timers, & furnaces are CSA approved
- Available with an angle or straight plug cap
- Free and split ends, ends stripped at 5/8"
- 13A rating with 16/3 cords



PART#	TYPE	LENGTH
8121	Angle plug	3 ft
8122	Angle plug	4 ft
8124	Angle plug	6 ft
8125	Angle plug	8 ft
8130	Straight plug	3 ft
8131	Straight plug	4 ft
8133	Straight plug	6 ft
8134	Straight plug	8 ft

HEAVY DUTY ELEMENT WRENCH



- Removes stubborn water heater elements
- Heavy duty construction
- 1-1/2" elements

PART#	DESCRIPTION
4946	Heavy duty element wrench

BOILER PLUG



- Screw on boiler plug

PART#	DESCRIPTION
4950	Boiler plug

THERMOCOUPLES - COPPER



- All thermocouples are furnished with universal adapters

PART#	LENGTH
9500	18"
9501	24"
9502	30"
9503	36"
9504	48"

ELEMENT GASKET

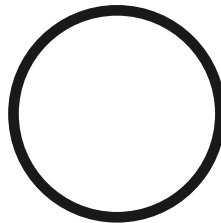

- Gaskets for replacement elements

PART#	DESCRIPTION
15520	Bolt on element gasket
15521	Screw on element gasket

SPECIALTIES

WATER HEATER PARTS

WATER HEATER ELEMENT

Element Style for 1500 Watt



Element Style for 3000 & 4500 Watt



- LYNCAR's quality hot water elements are manufactured to OEM standards
- Available in several voltages and styles
- Screw in, four bolt

FOUR BOLT	SCREW IN	WATTS / VOLTAGE / DENSITY
15500	15550	1500 watt / 120 volt / 75 density
15510	15560	3000 watt / 240 volt / 75 density
15515	15565	4500 watt / 240 volt / 75 density

WATER HEATER PAN - PLASTIC



- For electric water heaters ONLY
- Durable plastic pans will not rust, corrode or crack
- 1" drain fitting included- 2-1/2" high sides
- Pre-cut side opening for drain fitting
- Box quantity only

PART#	MATERIAL	SIZE
11500	Plastic	24"
11501	Plastic	26"
11502	Plastic	30"

WATER HEATER PAN - ALUMINUM



- For gas or electric water heaters
- Will not rust, corrode or crack
- 1" drain fitting included
- Pre-cut side opening for drain fitting
- Box quantity only

PART#	MATERIAL	SIZE
11503	Aluminum	24"
11504	Aluminum	26"
11505	Aluminum	30"

WATER HEATER ANODE ROD



11509 Aluminum Flexible (3 Section)



- Box quantity only



PART#	OD	SIZE	DESCRIPTION
11507	5/8"	42"	Aluminum
11508	3/4"	42"	Aluminum
11509	3/4"	42"	Aluminum flexible (3 Section)
11510	3/4"	42"	Aluminum with dielectric nipple

SPECIALTIES

WALL PLATES

SPLIT PLASTIC FLOOR & CEILING PLATE

- Simply bend and place around pipe.
- Chrome or white finish 100% rustproof
- Non-corrosive, non-breakable



IF WHITE IS REQUIRED ADD SUFFIX "W" TO PART#

PART#	IPS	CWT	OD
202856	1/2"		2-3/4"
202857	3/4"		3"
202858	1"		3-1/4"
202859	1-1/4"		3-1/2"
202860	1-1/2"		4-1/4"
202861	2"		4-1/4"
202862	2-1/2"		5-1/4"
202863	3"		5-3/4"
202864	4"		6-3/4"
202865	5"		8-1/2"
202866	6"		9-3/4"
202868	8"		12-3/4"
202873		1/2"	2-1/2"
202874		3/4"	2-3/4"
202875		1"	3"
202876		1-1/4"	3-1/4"
202877		1-1/2"	3-1/2"
202878		2"	4-1/2"

PLATE - FLOOR & CEILING - SURE GRIP

- Chrome plated steel
- Light pattern - no springs



PART#	IPS	CWT	OD
NA	3/8"		3"
207800	1/2"		2-3/4"
207805	3/4"		2-3/4"
207810	1"		3-1/2"
207815	1-1/4"	1-1/4"	3-1/2"
207820	1-1/2"	1-1/2"	3-1/2"
207825	2"		4-1/2"
207830		1/2"	3"
207835		3/4"	2-3/4"
207840		1"	2-3/4"
207845		1-1/4"	3-1/2"
207850		1-1/2"	

PLATE - FLOOR & CEILING - HEAVY PATTERN W/ SPRINGS

- Chrome plated steel



PART#	IPS	OD
207700	1/2"	2-3/4"
207705	3/4"	2-3/4"
207710	1"	3-1/4"
207715	1-1/4"	3-1/2"
207720	1-1/2"	4"
207725	2"	4-1/2"
207730	2-1/2"	5-1/2"
207735	3"	6"
207740	4"	6-1/2"
207745	5"	9"
207750	6"	9-3/4"
207755	8"	13"
207760	10"	16"

SPECIALTIES

**CAST IRON WALL
PLATE W/ SET SCREW**



- LYNCAR's cast iron wall plate is comparable to the GRINNELL 395 wall plate
- Available from 1/2" to 4" plated finish
- Galvanized finish

PART#	SIZE
95100G	1"
95114G	1-1/4"
95112G	1-1/2"
95200G	2"
95212G	2-1/2"
95300G	3"
95400G	4"

CAST IRON DRAIN CAP



- Sewer cap
- Clamps to soil pipe spigot
- Fits 3" or 4" pipe

PART#	DESCRIPTION
60005	Cast iron drain cap, painted

CLEANOUT - COVER PLATES



- Polished stainless steel
- Countersunk hole will accept both 1/4" and 5/16" bolts
- Covers unsightly waste cleanouts
- Polished face covered with protective paper
- 22 gauge metal

PART#	TYPE	PIPE SIZE
1629	Cover plate screw ONLY	1/4" x 20" x 2-1/2"
1649	Cover plate screw ONLY	1/4" x 20" x 4"
1659	Cover plate screw ONLY	5/16" x 18" x 4"
1840	Cover plate w/ 1/4" x 20" x 4" bolts	3"
1841	Cover plate w/ 1/4" x 20" x 4" bolts	4"
1842	Cover plate w/ 1/4" x 20" x 4" bolts	5"
1843	Cover plate w/ 1/4" x 20" x 4" bolts	6"
1844	Cover plate w/ 1/4" x 20" x 4" bolts	7"
1845	Cover plate w/ 1/4" x 20" x 4" bolts	8"

DIELECTRIC UNIONS



PART#	TYPE	SIZE
2590	FPT x sweat	3/4" FIP x 1/2" CWT
2592	FPT x sweat	1/2" FIP x 1/2" CWT
2594	FPT x sweat	3/4" FIP x 3/4" CWT
2596	FPT x sweat	1" FIP x 1" CWT
2597	FPT x sweat	1-1/4" FIP x 1-1/4" CWT
2598	FPT x sweat	1-1/2" FIP x 1-1/2" CWT
2599	FPT x sweat	2" FIP x 2" CWT
2589	MPT x sweat	3/4" MIP x 3/4" CWT
2591	MPT x sweat	3/4" MIP x 1/2" CWT

CLEANOUT PLUGS

BRASS PLUGS CLEANOUT - SOUTHERN STYLE



PART#	SIZE	DESCRIPTION
1846	1-1/2"	Raised head
1847	2"	Raised head
1848	2-1/2"	Raised head
1849	3"	Raised head
1850	3-1/2"	Raised head
1851	4"	Raised head
1875	5"	Raised head
1876	6"	Raised head
1852	1-1/2"	Countersunk square
1853	2"	Countersunk square
1854	2-1/2"	Countersunk square
1855	3"	Countersunk square
1856	3-1/2"	Countersunk square
1857	4"	Countersunk square
1878	5"	Countersunk square
1879	6"	Countersunk square

- Countersunk plugs can be tapped with 5/16" threads upon request.
- Countersunk plugs may be ordered "not tapped through" by adding -NT to the PART#

BRASS PLUGS CLEANOUT - UPC STYLE



PART#	SIZE	DESCRIPTION
1858	1-1/2"	Raised head
1859	2"	Raised head
1860	2-1/2"	Raised head
1861	3"	Raised head
1862	3-1/2"	Raised head
1863	4"	Raised head
1890	5"	Raised head
1864	1-1/2"	Countersunk slotted
1865	2"	Countersunk slotted
1866	2-1/2"	Countersunk slotted
1867	3"	Countersunk slotted
1868	3-1/2"	Countersunk slotted
1869	4"	Countersunk slotted
1891	5"	Countersunk slotted

- Countersunk plugs can be tapped with 5/16" threads upon request.
- Countersunk plugs may be ordered "not tapped through" by adding -NT to the PART#

UNIFORM SCHEME FOR THE IDENTIFICATION OF PIPING SYSTEMS APPLICATIONS

Positive identification of a piping system shall be done by lettered legend and colour. The name of a given content shall be spelled in full or abbreviated. Colour bands cannot be used alone without a legend.

The markers (hereafter referred to as a legend on a colour band) should be applied to pipe to designate the four main classifications and should be installed at frequent intervals, close to all valves, adjacent to all changes in direction where pipe passes through walls and floors or at junction points of distribution.

When arrows are used they must point away from pipe marker legend and in direction of flow. Double arrows should be used if flow can be in either direction.

These Markers are colour coded according to American National Standard Institute Specifications ANSI A- 13.1, along with a legend on the colour markers insures double identification protection (OSHA 1910.144, 1910.147, and 1910.261, 1910.262 and 1910.264, ANSI A-31.1.1981)

Material is a high quality performance 6 mil stabilized vinyl. Will not tear, durable and PRINTING IS BURIED under a protective cover. Will take temperatures up to 260°F. For Indoor or outdoor use.

Recommend Label Selection		
Outside Diameter Pipe System	Size of Letters	Label Style
1" to 2-1/2"	1"	A
2 - 1/2" to 7"	2"	B

Style "A"
1" Letters on a
1-1/8" x 14-1/2" Backer
4 per card

NATURAL GAS	NATURAL GAS
NATURAL GAS	NATURAL GAS

Style "B"
2" Letters on a
2-1/4" x 14-1/2" Backer
1 per card

NATURAL GAS

STANDARD COLOUR SYSTEMS PER OSHA & ANSI



DANGEROUS MATERIALS. This group includes materials which are hazardous to life or property because they are easily ignited, toxic, corrosive at high temperatures and pressures, productive of poisonous gases or are in themselves poisonous. It also includes materials that are known ordinarily as fire producers or explosives.

FIRE PROTECTION, MATERIALS AND EQUIPMENT. This classification includes sprinkler systems and other firefighting or fire protection equipment. The identification for this group of materials may also be used to identify or locate such equipment as alarm boxes, extinguishers, fire blankets, fire doors, hose connections, hydrants and any other fire-fighting equipment.

PROTECTIVE MATERIALS. This group includes materials which are piped through plants for the express purpose of being available to prevent or minimize the hazard of the dangerous materials above mentioned. It would include certain special gases which are antidotes, to counteract poisonous fumes, piped for the express purpose of release in case of danger. This classification also covers protective materials for purposes other than for fire protection which is covered under the section Fire Protection Materials and Equipment.

SAFE MATERIALS. This group includes those materials involving little or no hazard to life or property in their handling. This classification includes materials at low pressures and temperatures which are neither toxic nor poisonous and will not produce fire or explosions. People working on piping systems carrying these materials run little risk even though the system had not been emptied.

PIPE LABELS - PRESSURE SENSITIVE



Many other phrases available now at LYNCAR.
Please let us know your requirements.
All pipe markers can be customer made (min 25 cards)

Label Style "A"
1" Letters on a
1-1/8" x 7-1/4" Backer
4 per card

Label Style "B"
2" Letters on a
2-1/4" x 14-1/2" Backer
1 per card

SPECIALTIES

PART#	LABEL STYLE	WORDING	LETTER COLOUR	CARD COLOUR
75105	A	Chilled Water Ret.	White	Green
75104	B	Chilled Water Ret.	White	Green
75107	A	Chilled Water Sup.	White	Green
75106	B	Chilled Water Sup.	White	Green
75101	A	City Water	White	Green
75100	B	City Water	White	Green
75128	2 per card	CO2	Black	Yellow
75103	A	Compressed Air	Black	Yellow
75102	B	Compressed Air	Black	Yellow
75222	A	Condensate	White	Green
75121	A	Diesel Fuel	Black	Yellow
75120	B	Diesel Fuel	Black	Yellow
75109	A	Dom. Cold Water	White	Green
75108	B	Dom. Cold Water	White	Green
75109R	A	Dom. C.W. Return	White	Green
75108R	B	Dom. C.W. Return	White	Green
75108S	B	Dom. C.W. Supply	White	Green
75111	A	Dom. Hot Water	Black	Yellow
75110	B	Dom. Hot Water	Black	Yellow
75099	B	Dom. H.W. Recirc.	Yellow	Black
75113	A	Dom. H.W. Recirc.	Black	Yellow
75112	B	Dom. H.W. Recirc.	Black	Yellow
75115	A	Dom. H.W. Recirc.	White	Green
75114	B	Dom. H.W. Recirc.	White	Green
75119	A	Dom. H.W. Supply	White	Green
75118	B	Dom. H.W. Supply	White	Green
75119R	A	Dom. H.W. Return	White	Green
75118R	B	Dom. H.W. Return	White	Green
75116	B	Drain	White	Green
75117	A	Drain	White	Green
75183	A	Eau Gicleur	Red	White
75184	B	Eau Gicleur	Red	White
75123	A	Fan Coil Return	Black	Yellow
75122	B	Fan Coil Return	Black	Yellow
75125	A	Fan Coil Supply	Black	Yellow
75124	B	Fan Coil Supply	Black	Yellow

Label Style "A"
 1" Letters on a
 1-1/8" x 7-1/4" Backer
 4 per card

Label Style "B"
 2" Letters on a
 2-1/4" x 14-1/2" Backer
 1 per card

PART#	LABEL STYLE	WORDING	LETTER COLOUR	CARD COLOUR
75191	A	Fire Protection Water	Red	White
75192	B	Fire Protection Water	Red	White
75127	A	Fuel Oil	Black	Yellow
75126	B	Fuel Oil	Black	Yellow
75160F	A	Gaz Naturel	Black	Yellow
75159F	B	Gaz Naturel	Black	Yellow
75187	A	Gicleur	Red	White
75188	B	Gicleur	Red	White
75129	A	Glycol	Black	Yellow
75197	A	Glycol	Black	Yellow
75198	B	Glycol	Black	Yellow
75129R	A	Glycol	White	Red
75128R	B	Glycol	White	Red
75135	A	Glycol Cool. Ret.	Black	Yellow
75134	B	Glycol Cool. Ret.	Black	Yellow
75137	A	Glycol Cool. Sup.	Black	Yellow
75136	B	Glycol Cool. Sup.	Black	Yellow
75133	A	Glycol Htg. Ret.	Black	Yellow
75132	B	Glycol Htg. Ret.	Black	Yellow
75131	A	Glycol Htg. Sup.	Black	Yellow
75130	B	Glycol Htg. Sup.	Black	Yellow
75138	B	Glycol Make-up	Black	Yellow
75215	A	Heating Return	Black	Yellow
75216	B	Heating Return	Black	Yellow
75217	A	Heating Supply	Black	Yellow
75218	B	Heating Supply	Black	Yellow
75150	B	Hot Water Heating	Yellow	Black
75210	A	H.W. Heating Return	Yellow	Black
75211	B	H.W. Heating Return	Yellow	Black
75153	A	Low Press. Cond.	Black	Yellow
75154	B	Low Press. Steam	Black	Yellow
75155	A	Low Press. Steam	Black	Yellow
75156	B	Med. Press. Cond.	Black	Yellow
75157	A	Med. Press. Cond.	Black	Yellow
75158	B	Med. Press. Steam	Black	Yellow
75159	A	Natural Gas	Black	Yellow
75160	B	Natural Gas	Black	Yellow
75159A	A	Nitrogen	Blue	White
75166N	A	Non Potable Water	White	Green
75166NP	A	Non Potable Water	White	Green
75165N	B	Non Potable Water	White	Green
75161	A	Oxygen	White	Green
75162	B	Oxygen	White	Green
75163	A	Plumbing Vent	White	Green
75164	B	Plumbing Vent	White	Green

Label Style "A"
1" Letters on a 1-1/8" x 7-1/4"
Backer
4 per card

Label Style "B"
2" Letters on a
2-1/4" x 14-1/2" Backer
1 per card

PART#	LABEL STYLE	WORDING	LETTER COLOUR	CARD COLOUR
75165	A	Potable Water	White	Green
75166	B	Potable Water	White	Green
75167	A	Propane Gas	Black	Yellow
75168	B	Propane Gas	Black	Yellow
75207	A	Return	Yellow	Black
75207A	B	Return	Yellow	Black
75209	B	Reverse Osmosis Water	White	Green
75174S	B	Sanitary	Green	White
75213	B	Sanitary Drain	Green	White
75173	A	Sanitary Sewer	White	Green
75174	B	Sanitary Sewer	White	Green
75141	A	Siamese	Red	White
75140	B	Siamese	Red	White
75181	A	Sprinkler Water	Red	White
75182	B	Sprinkler Water	Red	White
75185	A	Sprinkler Fire	Red	White
75186	B	Sprinkler Fire	Red	White
75169	A	Steam Supply	Black	Yellow
75170	B	Steam Supply	Black	Yellow
75189	A	Standpipe	Red	White
75190	B	Standpipe	Red	White
75171	A	Storm Sewer	White	Green
75172	B	Storm Sewer	White	Green
75175W	B	Storm Water	White	Green
75208	A	Supply	Yellow	Black
75208A	B	Supply	Yellow	Black
75214	B	Tempered Dom. Hot Water	Yellow	Black
75199	B	Tempered Water Return	White	Green
75175	A	Arrows	Red	White
75176	B	Arrows	Red	White
75177	A	Arrows	Yellow	Black
75178	B	Arrows	Yellow	Black
75179	A	Arrows	Red	Green
75180	B	Arrows	Red	Green
75175	A	Arrows	Red	White
75176	B	Arrows	Red	White
75177	A	Arrows	Yellow	Black
75178	B	Arrows	Yellow	Black
75179	A	Arrows	Red	Green
75180	B	Arrows	Red	Green

PIPE LABELS ON-A-ROLL



Pipe Markers on-a-roll are manufactured from pressure sensitive vinyl with aggressive permanent adhesive. This style of marker provides 360° visibility.

The ABCs of ordering "Pipe Markers On-A-Roll"

STEP A Select Tape & Letter Colour on Chart "A"

STEP B Select Wording from Chart "B"

STEP C Check your Usage requirements on Chart "C"

Sample Pipe Marker On-A-Roll Ordering

Product Code + "A" + "B" = **Part Number**

PMR - **BY** - **114**

STEP "A" - Select Tape & Lettering Colour

COLOUR CODE	STANDARD COLOURS
BY	Black on Yellow
WG	White on Green
WR	White on Red
WB	White on Blue

STEP "B" - Select a Wording

ORDER CODE	STANDARD WORDING	ORDER CODE	STANDARD WORDING
99	"Custom Wording"	118	Glycol Cool. Sup.
101	City Water	119	Low Press. Cond.
102	Compressed Air	120	Low Press. Steam
103	Chilled Water Ret.	121	Med. Press. Cond.
104	Chilled Water Sup.	122	Med. Press. Steam
105	Dom. Cold Water	123	Natural Gas
106	Dom. Hot Water	124	Oxygen
107	Dom. H.W. Recirc.	125	Plumbing Vent
108	Drain	126	Potable Water
109	Dom H.W. Supply	127	Propane Gas
110	Diesel Fuel	128	Steam Supply
111	Fan Coil Return	129	Storm Sewer
112	Fan Coil Supply	130	Sanitary Sewer
113	Fuel Oil	131	Arrows
114	Glycol	132	Sprinkler Water
115	Glycol Htg. Sup.	133	Sprinkler Fire
116	Glycol Htg. Ret.	134	Standpipe
117	Glycol Cool. Ret.		

STEP "C" - Calculate Rolls Required

1 ROLL 30' LONG WITH LABEL	
PIPE OD	TIMES
1"	100
2"	55
3"	36
4"	27
5"	20
6"	18

SNAP PLASTIC LABELS



Pipe Huggers are the best form of markers on today's market. These markers are constructed from plastic and are pre-coiled for pipes from 1/2" thru 6". Constructed from .020 rigid vinyl, with subsurface printing for maximum chemical resistance. This style of marker provides 360° visibility.

Temperature rating for pipe huggers:
-40 degrees F. to 140 degrees F.

STEP THE "ABCs" of Pipe Hugger Ordering

- A** Select "Hugger Size" from Chart "A"
- B** Select Hugger Backer and Lettering Colour from Chart "B"
- C** Select "Wording" from Chart "C" or provide your own custom wording using Code 99

Sample Pipe Hugger Ordering

"A" + "B" + "C" = Part Number

PH4 -BY- 114

STEP "A"
Select a Pipe Hugger Size

HUGGER SIZE CODE	PIPE SIZE RANGE (OD)	LETTER SIZE
PH0	1/2"	1/2"
PH1	3/4" to 1-1/4"	1/2"
PH2	1-1/4" to 2-3/8"	3/4"
PH3	2-3/8" to 4-1/2"	1-1/4"
PH4	4-1/2" to 6"	1-1/4"
PH5	6" to 8"	2-1/4"
PH6	8" to 10"	2-1/2"
PH7	10" to 15"	3-1/2"

STEP "B"
Select a Colour Scheme

COLOUR CODE	STANDARD COLOURS
BY	Black on Yellow
WG	White on Green
WR	White on Red
WB	White on Blue

STEP "C"
Select a Wording

ORDER	WORDING	ORDER	WORDING
99	"Custom Wording"	116	Glycol Htg. Ret.
101	City Water	117	Glycol Cool. Ret.
102	Compressed Air	118	Glycol Cool. Sup.
103	Chilled Water Ret.	119	Low Press. Cond.
104	Chilled Water Sup.	120	Low Press. Steam
105	Dom. Cold Water	121	Med. Press. Cond.
106	Dom. Hot Water	122	Med. Press. Steam
107	Dom. H.W. Recirc.	123	Natural Gas
108	Drain	124	Oxygen
109	Dom H.W. Supply	125	Plumbing Vent
110	Diesel Fuel	126	Potable Water
111	Fan Coil Return	127	Propane Gas
112	Fan Coil Supply	128	Steam Supply
113	Fuel Oil	129	Storm Sewer
114	Glycol	130	Sanitary Sewer
115	Glycol Htg. Sup.	131	Arrows

SPECIALTIES

BARRICADE TAPE



- 1000' roll single

ARROW TAPE



- 2" wide rolls by 55 yard, 3 mil PVC tape

PART#	DESCRIPTION
15000	CAUTION
15014	CAUTION MEN WORKING
15018	CAUTION CONSTRUCTION AREA

PART#	DESCRIPTION
75195R	Red tape / white arrow
75195Y	Yellow tape / black arrow
75195G	Green tape / white arrow

NATURAL GAS ID TAPE



- Natural gas pipe identification tape
 - Supplied by the self adhesive roll
 - 2" wide rolls by 60 yard, 3 mil PVC tape

ANCHOR KIT



- EACH SET CONTAINS:
 - 100 #8-10 collar anchors
 - 100 #10 x 1" Phillips with Hex head screws
 - 1/4" carbide tipped masonry drill
 - Transparent, reusable box
 - Phillips hex head screws allow a nutdriver, nut setter or screwdriver to be used.

PART#	DESCRIPTION
75195NG	Natural gas ID tape

PART#	DESCRIPTION
1600	Anchor kit

CHAIN - BRASS SIGN HANGING



- Brass sign hanging chain for signage and tags
 - 100 and 250-foot rolls or pre-cut 4" length with connector



BRASS TAGS



- Solid brass tags
 - 1-1/4" diameters
 - Black ink filled
 - Sold as sets with
 - 4" brass hanging chain
 Yes, we take custom orders too !

PART#	DESCRIPTION
305735	Roll of chain brass 100'
305740	Roll of chain brass 250'
305741	Roll of chain brass 500'
305745	Clips for above (per 100)
305730	Sign chain 4 1/2" long brass

PART#	DESCRIPTION
305749	Blanks (No chain)
305750	Set # 1 - 6 with chain
305755	Set # 1 - 7 with chain
305760	Set # 1 - 25 with chain
305765	Set # 1 - 50 with chain
305770	Set # 1 - 100 with chain
305775	Brass Tag "A"
305780	Brass Tag "B"
305772	Set # 101 - 200 with chain
305773	Set # 201 - 300 with chain

FIRE PROTECTION

In addition to our plumbing business, LYNCAR has been a leading supplier to the Canadian fire protection industry for over 40 years. LYNCAR provides fire protection wholesalers with thousands of products including:

- Escutcheons and wallplates
- A full line of GLOBE sprinkler heads
- Sprinkler gauges
- Signage and labels for fire protection systems
- Beam clamps, ring hangers and other pipe-hanging accessories for sprinkler systems
- Electrical items such as Potter switches
- Fire-rated specialty chemicals such as pipe sealants and premixed anti-freeze
- Specialty valves
- Head guards
- Many other fire sprinkler specialties

Please contact our order desk or check our website for more information on how we may serve your customers' fire protection needs, or to get our fire protection wholesale catalogue.

**Thousands
of Fire Sprinkler
Specialty Products**

One Source.
www.lyncar.com

SPRINKLER HEADS

**SPRINKLER HEADS – STANDARD RESPONSE
1/2" IPS**



G566115501



G56015502



G565115502

- Temperature rating 155°
- 5mm glass bulb sprinklers 1/2" orifice x 1/2" NPT
- K FACTOR 5.6
- cULus & FM approved

PART#	DESCRIPTION
G566115501	Upright - 1/2" IPS brass
G567015502	Horizontal sidewall - 1/2" IPS chrome
G565115502	Pendent - 1/2" IPS chrome

**SPRINKLER HEADS – QUICK RESPONSE
1/2" IPS**



G561515501



G562615502



G560115502

- Temperature rating 155°
- 3mm glass bulb sprinklers 1/2" orifice x 1/2" NPT
- K FACTOR 5.6
- cULus & FM approved

PART#	DESCRIPTION
G561515501	Upright - 1/2" IPS brass
G562615502	Horizontal sidewall - 1/2" IPS chrome
G560115502	Pendent - 1/2" IPS chrome

SPECIALTIES

SPRINKLER HEADS

HEAD - CONCEALED, S.R. & Q.R.
"THE INCH"

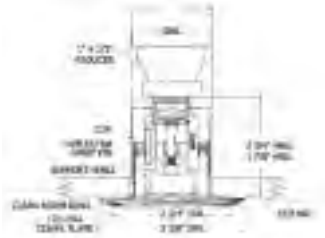

- Water working pressure rating – 175 PSI
- Factory tested hydrostatically to 500 PSI
- Maximum low temperature glass bulb rating is -67°F (-55°C)
- Strong wrap around pin, drop in design
- Available in 155°
- White plate 2-3/4" diameter
- cULus and FM approved

PART#	DESCRIPTION
G560615501W	Quick Response
G565315501W	Standard Response

RESIDENTIAL "THE INCH"

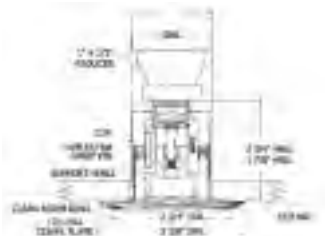

- Water working pressure rating – 175 PSI
- Factory tested hydrostatically to 500 PSI
- Maximum low temperature glass bulb rating is -67°F (-55°C)
- Strong wrap around pin, drop in design
- Available in 155°
- White plate 2-3/4" diameter
- cULus and FM approved

PART#	DESCRIPTION
G490615501W	Residential

RESIDENTIAL SPRINKLER HEAD - 1/2" IPS



- 3mm frangible glass bulb
- Residential sprinklers are the ultimate in life safety and fire control
- Install in accordance with the appropriate NFPA Standard 13, 13D or 13R and under the direction of the approving authorities having jurisdiction.
- Temperature rating 0 155° F (68° C)
- Water working pressure rating – 175 PSI
- Chrome pendent 155°
- cULus approved

PART#	DESCRIPTION
G561015502	Pendent, K FACTOR 5.6

SPRINKLER SPECIALTIES

RECESSED ESCUTCHEON



- Recessed escutcheon for pendent sprinkler head
- Chrome or white standard
- Also available in black & brass
- Sprinkler head sold separately

PART#	FINISH	IPS
205200	Chrome	1/2"
205215	Chrome	3/4"
205210	White	1/2"
205225	White	3/4"

ESCUTCHEON - RECESSED THREADED 2 PC PLATE



- Made to allow for minor adjustments to pipe or ceiling pitch
- Can be removed or reinstalled, allowing access above removable ceiling panels without shutting down the sprinkler system
- Threaded skirt & cup for 1/2" adjustment

PART#	DESCRIPTION
205213	Chrome
205214	White

ESCUTCHEON - RECESSED RETROFIT



- 3 piece recessed escutcheon
- Centre section splits into 2 pieces and snap together
- Chrome plated escutcheon without shutting down the system

PART#	DESCRIPTION
205200R	Chrome, 1/2" IPS

STANDARD ESCUTCHEON 1 PC



- Standard Escutcheon for pendent sprinkler head.
- Chrome or White standard.

PART#	FINISH	IPS
205100	Chrome	1/2"
205105	Chrome	3/4"
205110	White	1/2"
205105W	White	3/4"

OVERSIZED REPAIR PLATE



- Increase the coverage area when using 2 pc recessed plates or 1 pc plates
- Used in repair when hole is oversized from previous sprinkler
- Also suitable for earthquake zone areas where 1" is required for the flange
- Total coverage is 5"
- Sprinkler head sold separately

PART#	DESCRIPTION
205301	Chrome
205302	White

SPRINKLER SPECIALTIES

HEAD CABINETS



- LYNCAR stocks spare head cabinet for 6 or 12 heads
- Sprinkler head sold separately

PART#	DESCRIPTION
305621	6 head box
305619	12 head box

HEAD GUARDS



305660



305699



305675



305692

- LYNCAR stocks many different head guards for fire sprinkler applications

PART#	STYLE
305660	Red 1 pc 2 hook 1/2" or 3/4" IPS
305675	Red 2 pc heavy duty 1/2" IPS
305690	Red 1 pc 2 hook with shield
305692	Mini guard chrome for 1/2" or 3/4" IPS
305699	Head guard for recessed plate

ESCUTCHEON - RETROFIT



- These rings are used to conceal oversized holes and cutting errors in ceiling tiles, drywall or other ceiling materials
- These products split so the system does not have to be shut down or the sprinkler head removed. The 1-1/2" ID is standard and the 2-1/2" ID is for semi recessed escutcheons
- 4" coverage

PART#	FINISH	ID	OD
205240	White - Kydex	1-1/2"	4"
205242	White - Kydex	2-1/2"	4"

NIPPLES - CHEATER BRASS HEX



- 1/2" IPS brass cheater nipples, used when the sprinkler head requires adjustment down from the existing position

PART#	ADJUSTMENT
205623	1/2"
205624	3/4"
205625	1"
205626	1-1/2"
205627	2"

POTTER FLOW & PRESSURE SWITCHES

SWITCH - POTTER FLOW



- Potter flow switch
- Paddle type flow switch
- Available from 1" to 10" pipe sizes
- Service pressure to 450 PSI,
- ULC and FM approved



PART#	SIZE
4070112	1/2" - 2"
4070200	2"
4070300	3"
4070400	4"
4070600	6"

SWITCH - POTTER PRESSURE



- Potter pressure switches
- Single & double contacts
- ULC and FM approved



PART#	DESCRIPTION
4071102A	Low pressure double contact (PS10-2A)
407110	Low pressure single contact (PS10)
407140	Air pressure single contact (PS40) **
4071120	Pressure supervision switch (PS120) **

** Also available as double contact models

SWITCH - POTTER OSY & PCVS



part#404072 - OSY



part#404073 - PCVS

- Potter OSY & PCVS supervisory switches are double contact switches, for OSY valves or for PIB valves
- FM approved



PART#	DESCRIPTION
404072	OSY
404073	PCVS

J

NOTES

SPECIALTIES

bEAM cLAMPS

bEAM cLAMP - STANdARd



- LYNcAR beam clamps:**
- Black or zinc plated finishes
 - Malleable iron ASTM A47
 - Grade 32510
 - 3/8" UNC set screw thread
 - ULC, UL, & FM approved



PART#	FINISH	Rod SIzE	MAx. PIPE SIzE	MAx. REc. LoAd / LbS.
109038	Black	3/8"	3/4 to 4"	400
109012	Black	1/2"	5" to 8"	500
109038G	Plated	3/8"	3/4 to 4"	400
109012G	Plated	1/2"	5" to 8"	500

bEAM cLAMP - WIdE MoUTh



- LYNcAR beam clamps:**
- Black or zinc plated finishes
 - Malleable iron ASTM A47
 - Grade 32510
 - 3/8" UNC set screw thread
 - ULC, UL, & FM approved



PART#	FINISH	Rod SIzE	MAx. PIPE SIzE	MAx. REc. LoAd / LbS.
109038W	Black	3/8"	3/4 to 4"	400
109012W	Black	1/2"	5" to 8"	500
109038WG	Plated	3/8"	3/4 to 4"	400
109012WG	Plated	1/2"	5" to 8"	500

bEAM cLAMP - PuRLIN



- Designed for use with large lip rolled steel purlins to eliminate the need to modify steel purlin for standard C-clamp
- Malleable iron with hardened steel cup point set screw

PART#	FINISH	Rod SIzE	MAx. PIPE SIzE	MAx. REc. LoAd / LbS.
109038P	Black	3/8"	4"	400

bEAM cLAMP WRENcH



- A specially made ratchet wrench for easy installation of beam clamps

PART#	dEScRIPTIoN
9955	Beam clamp wrench

HANGERS & FITTINGS

HANGER SPECIALTIES

Wood ScREWS



- Robertson (square) drive
- Plated
- 100 per box



PART#	SIzE	LENGTH	PART#	SIzE	LENGTH
1520	#8	1/2"	1531	#10	1/2"
1521	#8	3/4"	1532	#10	3/4"
1522	#8	1"	1533	#10	1"
1523	#8	1-1/4"	1534	#10	1-1/4"
1524	#8	1-1/2"	1535	#10	1-1/2"
1525	#8	2"	1536	#10	2"
1526	#8	2-1/2"	1537	#10	2-1/2"
1527	#8	3"	1538	#10	3"

LAG bo LTS

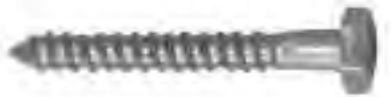

PART#	dEScRIPTIoN	PART#	dEScRIPTIoN
1099101	1/4" x 2"	1099104	3/8" x 3"
1099102	1/4" x 2-1/2"	1099105	3/8" x 4"
1099103	3/8" x 2"	1099107A	1/2" x 2-1/2"
1099107	3/8" x 2-1/2"	1099108	1/2" x 4"

SHEET METAL ScREWS



- Robertson (square) drive
- Plated
- 100 per box



PART#	SIzE	LENGTH	PART#	SIzE	LENGTH
1817	# 8	1/2"	1821	# 8	1"
1819	# 8	3/4"	1871	# 10	3/4"

STovE bo LT



- Round head with hex nuts
- 100 bolts and nuts per box

PART#	SIzE	PART#	SIzE
1635	3/16" x 3/4"	1641	1/4" x 1"
1637	3/16" x 1-1/4"	1642	1/4" x 1-1/4"
1639	1/4" x 1/2"	1643	1/4" x 1-1/2"
1640	1/4" x 3/4"	1644	1/4" x 2"

SELF dRILLING SHEET METAL ScREWS



- Robertson (square) drive
- Self drilling point plated
- 100 per box



PART#	SIzE	LENGTH
1830	# 8	1/2"
1831	# 10	1-1/2"
1832	# 10	2"

HANGER SPECIALTIES

SELF NAILING PROTECTION PLATE



- 100 per box

PART#	SIZE	UNCOATED
1628	2" x 5"	20
1630	2" x 5"	16

HANGER - PIPE STRAPS



- Galvanized

PART#	IPS SIZE	PART#	IPS SIZE
1614	1/2"	1619	2"
1615	3/4"	1620	2-1/4"
1616	1"	1621	3"
1617	1-1/4"	1622	4"
1618	1-1/2"		

HANGER - WIRE PIPE HOOKS



- 50 per box

- Uncoated

PART#	SIZE	PART#	SIZE
1560	1/2" x 4"	1566	3/4" x 8"
1561	1/2" x 6"	1567	3/4" x 10"
1564	3/4" x 4"	1569	1" x 6"
1565	3/4" x 6"		

CABLE TIES



- Nylon cable ties can be used in countless applications and are adaptable to any environment and can be used both inside and outdoors

- UV protected, black colour

PART#	COLOR	SIZE	PART#	COLOR	SIZE
877	Black	7-1/2"	8721	Black	21"
8711	Black	11"	877W	white	7-1/2"
8714	Black	14"	8711W	white	11"

ANCHOR KIT



EACH SET CONTAINS:

- 100 #8-10 collar anchors
- 100 #10 x 1" Phillips with Hex head screws
- 1/4" Carbide tipped masonry drill
- Transparent, reusable box
- Phillips hex head screws allow a nutdriver, nut setter or screwdriver to be used

PART#	DESCRIPTION
1600	Anchor kit

HANGER SPECIALTIES

ANGLE bRACkET



- For attachments to wood or steel beams, 2" x 1/2" bracket
- Hole to clear threaded rod

PART#	SIzE
-------	------

10990638	3/8"
----------	------

10990639	1/2"
----------	------

bELL HANGERS



PART#	SIzE
-------	------

108112	1/2"
--------	------

108134	3/4"
--------	------

108110	1"
--------	----

TIE boLT



- Tie bolt
- 3/4" x 4 1/2"
- For watermain service *Nut not included

PART#	dEScRIPTIoN
-------	-------------

10991801	Tie bolt only
----------	---------------

HANGER INSERT NuT



- Insert nuts plated for ring hangers

PART#	SIzE
-------	------

10992101	3/8"
----------	------

10992102	1/2"
----------	------

ToGGLE WING



- Toggle wing for 3/8" rod

PART#	dEScRIPTIoN
-------	-------------

10992001	Toggle wing
----------	-------------

Rod couPLING



- LYNCAR offers plated rod coupling in different sizes

PART#	SIzE
-------	------

1099081	3/8" x 1-3/4"
---------	---------------

1099082	3/8" x 1-1/4"
---------	---------------

1099083	1/2" x 1-3/4"
---------	---------------

1099084	5/8 x 2-1/4"
---------	--------------

1099085	3/4" x 2-1/4"
---------	---------------

Rod buTTon



- Plastic rod button for 3/8 rod
- Use in wood construction
- White finish

PART#	dEScRIPTIoN
-------	-------------

109901	Rod button
--------	------------

dEcK FLANGE

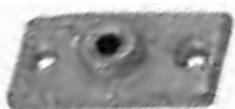

- Cast ceiling deck flange to support threaded rod 3/8" or 1/2" rod size

PART#	SIzE
-------	------

1099091MG	3/8" plated
-----------	-------------

1099092MG	1/2" plated
-----------	-------------

HANGER SPECIALTIES

MALLEABLE EYE SOCKET



- Available for 3/8" or 1/2" rod
- Use when swivel action is required

PART#	SIZE
10991901	3/8"
10991902	1/2"

EYE SOCKET



- Steel eye sockets for 3/8" or 1/2" threaded rod
- Straight or offset models
- 100 per box
- FM and cULus approved



PART#	SIZE
10990338	3/8"
10990312	1/2"
10990438	3/8" offset

SIDE BEAM CONNECTOR, STEEL



- Threaded for 3/8" rod
- Used in wood or steel construction
- 2" max pipe size
- cULus approved



PART#	DESCRIPTION
10990538	Side beam connector

SIDE BEAM CONNECTOR, MALLEABLE



PART#	DESCRIPTION
10990538M	Side beam connector

DROP IN CONCRETE ANCHORS



PART#	SIZE
1557	3/8" mini , 100 per box
1558	3/8", 50 per box
1559	1/2", 50 per box

ANCHOR SETTING TOOL



PART#	SIZE
1552	3/8" or 1/2"
155212	1/2"

HANGERS & FITTINGS

HANGER SPECIALTIES

PIPE STAYS - STANDARD

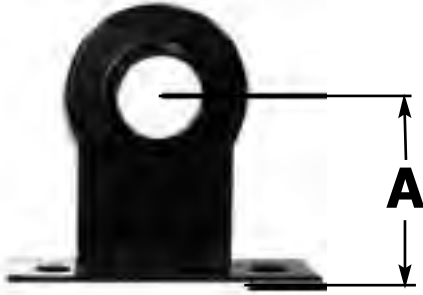

Standard

- LYNCAR's pipe stays are made of carbon steel & epoxy coated
- Used in water, heat & gas line. Copper & iron pipe sizes

PART#	COPPER	IPS	"A"
99400	1/2"	3/8"	1-7/16"
99401	3/4"	1/2"	1-7/16"
99402	1"	3/4"	1-5/8"
99403	1-1/4"	1"	1-5/8"
99404	NA	1-1/2"	2-13/16"
99405	1-1/2"	1-1/4"	2-1/2"
99406	NA	2"	2-15/16"
99407	2"	NA	2-13/16"

PIPE STAYS - EXTENDED AND DOUBLE

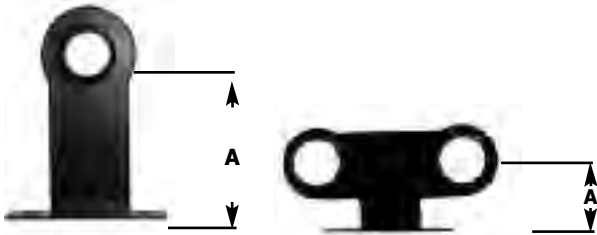

Extended

Double

PART#	COPPER	IPS	"A"	DESCRIPTION
99410	1/2"	3/8"	2-1/2"	Extended
99411	3/4"	1/2"	2-1/2"	Extended
99412	1"	3/4"	2-3/4"	Extended
99413	1-1/4"	1"	2-3/4"	Extended
99415	1/2"	3/8"	1-7/16"	Double
99416	3/4"	1/2"	1-7/16"	Double
99417	1"	3/4"	1-5/8"	Double

SPLIT RING HANGER



2 SCREW SPLIT RING HANGER

- LYNCAR's split ring hangers are available from 1/2" to 2" and in 2 screw, or hinged type.

PART#	PIPE SIZE	DESCRIPTION
1092038	3/8"	2 screw
1092012	1/2"	2 screw
1092034	3/4"	2 screw
1092100	1"	2 screw
1092114	1 1/4"	2 screw
1092112	1 1/2"	2 screw
1092200	2"	2 screw
1092038H	3/8"	Hinged
1092012H	1/2"	Hinged
1092034H	3/4"	Hinged
1092100H	1"	Hinged
1092114H	1 1/4"	Hinged
1092112H	1 1/2"	Hinged
1092200H	2"	Hinged



HINGED SPLIT RING HANGER

HANGER SPECIALTIES

K

SPRINKLER RING HANGER



- Available to 8" IPS
- Available Galvanized & PVC coated
- Sold in box quantities only
- LYNCAR'S sprinkler hangers are UL, FM, ULC approved



PART#	PIPE SIZE	DESCRIPTION
1091012	1/2"	PLATED
1091034	3/4"	PLATED
1091100	1"	PLATED
1091114	1 1/4"	PLATED
1091112	1 1/2"	PLATED
1091200	2"	PLATED
1091212	2 1/2"	PLATED
1091300	3"	PLATED
1091400	4"	PLATED
1091500	5"	PLATED
1091600	6"	PLATED
1091800	8"	PLATED
1091012Pc	1/2"	PVC
1091034Pc	3/4"	PVC
1091100Pc	1"	PVC
1091114Pc	1 1/4"	PVC
1091112Pc	1 1/2"	PVC
1091200Pc	2"	PVC
1091212Pc	2 1/2"	PVC
1091300Pc	3"	PVC
1091400Pc	4"	PVC

HANGER - J-Hook™ PLASTIC PIPE



Faster Installation - versatile Placement

- An exceptional hanger that saves time & money
- Assures greater accuracy in hanging, eliminates problems due to improper grades or movement after installation
- Eliminates measuring, adjusting, cutting & wrapping straps
- Hugs pipes snug & secure at easily determined grades
- Calibrated for 1/8" fall per foot (supported every 4 feet)
- Glueable with same adhesive used for pipe fittings
- 3" hook fits both Sch 30 and Sch 40 pipe
- Snap-in lock feature holds pipe securely, Nails included
- Use vertically or horizontally

PART#	SIZE
20053	1-1/2" x 7"
20054	2" x 7"
20055	3" x 7"
20056	4" x 7"

HANGERS & FITTINGS

SAMMY ScREWS

SAMMY x-PRESS SYSTEM INSTALLATIoN ToOLS



The SAMMY X-PRESS™ system is designed to provide direct attachment of threaded rod in metal deck (22-16 gauge) and thin gauge purlin (18-16 gauge), while providing reduced installation costs in terms of time and materials.

The X-PRESS anchors eliminate the need for costly “armovers” in pipe hanging installations. Current methods offered for thin gauge purlin require use of a time-consuming retaining nut on the threaded portion of the fastener to prevent pullout and are not designed for use in metal deck. In many instances, access to the backside of the installed fastener is prohibited by panel liner or roofing insulation. SAMMY X-PRESS anchors deliver the performance installers require without the use of a retaining nut!



The patent-pending X-PRESS anchors consist of a threaded fastener and expandable sleeve. The X-PRESS system features an easy-to-install anchor with expanding anchoring strips that collapse to prevent pullout after installation.



uninstalled

The XP 20 provides 750 pounds of pullout in 22-20 gauge metal deck and will support a 2” pipe. The XP 35 delivers 1250 pounds of pullout in 18-16 gauge purlin and supports a 3-1/2” pipe.

installed

PART#	dEScRiPTIoN
1089xP20	Support up to 2” pipe
1089xP35	Support up to 3-1/2” pipe

SAMMY x-PRESS IT INSTALLATIoN ToOL



The SAMMY X-PRESS It™ Installation Tool assures a perfect installation every time offering the added convenience of one-tool efficiency, just drill and drive in SECONDS!

PART#	dEScRiPTIoN
109914	SAMMY straight screw installation tool
109914S	SAMMY sidewinder screw installation tool
109915	SDS bit for Hilti™ drill (use with concrete SAMMYS)
109916	Sleeve tool (Tapcon method)
1089xPT	X-PRESS It™ installation tool
1089xPd	X-PRESS It™ drill bit 25/64

SAMMY ScREWS

SAMMY ScREWS FoR STEEL vERTICAL MoUNT

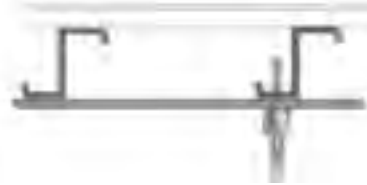
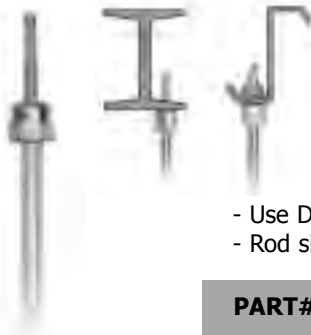

- Use Driver 109914
- Rod size is 3/8"

PART#	ModEL TYPE	SELF dRILLING / SELF TAPPING	SIZE	uL	FM
1089303	DST-10	In steel to .188"	1/4" x 1"		
1089301	DST-15	In steel to .188"	1/4" x 1-1/2"		
1089300	DST-30	In steel to .188"	1/4" x 3"		
1089202	DSTR 1	In steel to .188"	1/4" x 1"	X	X
1089203	DSTR 1-1/2	In steel to .188"	#12 x 1-1/2"	X	X
1086303	DSTR-516	In steel to .188"	5/16" x 1-1/4"	X	X
1089305	DST-516	In steel to .188"	5/16" x 1-1/4"	X	X
1089200	TEK-50	In steel to .50"	#12 x 1-1/2"	X	X



SAMMY ScREWS FoR STEEL HoRIZoNTAL MoUNT



- Use Driver 109914S
- Rod size is 3/8"

PART#	ModEL TYPE	SELF dRILLING/SELF TAPPING	SIZE	uL	FM
1086301	SWDR 1	In steel to 1/4"	1/4" x 1"	X	X
1089307	SWT 15	In steel to 1/2"	#12 x 1-1/2"		
1089306	SWDR-516	In steel to 1/2"	5/16" x 1-1/4"	X	X
1089309	SWDR 1-1/2	In steel to 1/2"	#12 x 1-1/2"	X	X



SAMMY ScREWS FoR STEEL SWIVEL MoUNT



- Use Driver 109914
- Rod size is 3/8"

PART#	ModEL TYPE	uSAGE	SIZE
1089303S	SH-DSTR 1	Self drilling in steel	1/4" x 1"

HANGERS & FITTINGS

SAMMY ScREWS

SAMMY ScREWS FoR Wood vERTICAL MoUNT



- Self threading in wood
- Rod size is 3/8"

PART#	ModEL TYPE	SIzE
1088200	GST-20	1/4" x 2"
1088300	GST-30	1/4" x 3"
1088380	GST-25-380	3/8" x 2-1/2"

SAMMY ScREWS FoR Wood HoRizoNTAL MoUNT



- Self threading in wood
- Rod size is 3/8"

PART#	ModEL TYPE	SIzE
1086302	SWG10	1/4" x 1"
1089302	SWG20	1/4" x 2"
1089380	SWG-25-380	3/8" x 2-1/2"

SAMMY ScREWS FoR Wood SWIVEL MoUNT



- Use Driver 109914
- Allows rod to hang plumb, No need to bend rod
- Deflection from vertical = 17°
- Accommodates 3-1/2" by 12" pitch roof
- Self threading in wood
- Rod size is 3/8"

PART#	ModEL TYPE	SIzE
1088200S	SH-GST 20	1/4" x 2"
1088300S	SH-GST 30	1/4" x 3"

SAMMY ScREWS

SAMMY ScREWS FoR dRYWALL vERTICAl MoUNT



- Use driver 109914
- Rod size is 3/8"

PART#	ModEL TYPE	SIzE
1086300	SST-30	1/4" x 3"

SAMMY ScREWS FoR coNcRETE vERTICAl MoUNT

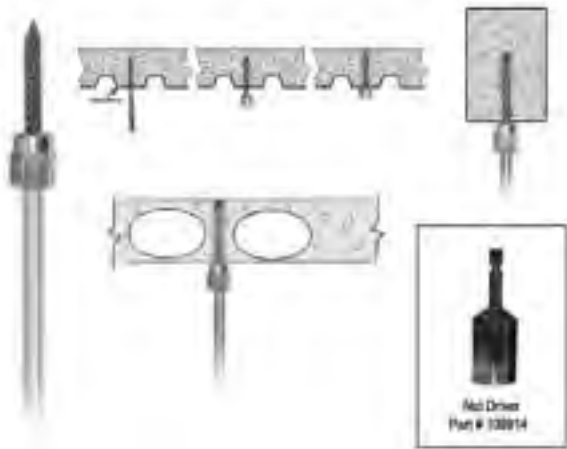

- Self tapping for concrete, pre-drilling
- Rod size is 3/8"

PART#	ModEL TYPE	SIzE
1087134	CST-20	5/16" x 1-3/4"

SAMMY ScREWS FoR coNcRETE HoRIZoNTAl MoUNT



- Use driver part# 109914S
- Self tapping for concrete, pre-drilling
- Rod size is 3/8"

PART#	ModEL TYPE	SIzE
1089304	SWC-20	5/16" x 1-3/4"

HANGERS & FITTINGS

FITTINGS & couPLINGS, bRASS

couPLING - Reducing, bRASS



PART#	SIzE	PART#	SIzE	PART#	SIzE
7118	1/4" x 1/8"	7132	1" x 1/4"	7145	2" x 3/4"
7119	3/8" x 1/4"	7134	1-1/4" x 1"	7146	2" x 1/2"
7120	3/8" x 1/8"	7135	1-1/4" x 3/4"	7147	2-1/2" x 2"
7123	1/2" x 3/8"	7136	1-1/4" x 1/2"	7148	2-1/2" x 1-1/2"
7124	1/2" x 1/4"	7137	1-1/4" x 3/8"	7149	2-1/2" x 1-1/4"
7125	1/2" x 1/8"	7138	1-1/2" x 1-1/4"	7150	2-1/2" x 1"
7126	3/4" x 1/2"	7139	1-1/2" x 1"	7151	3" x 2-1/2"
7127	3/4" x 3/8"	7140	1-1/2" x 3/4"	7152	3" x 2"
7128	3/4" x 1/4"	7141	1-1/2" x 1/2"	7153	3" x 1-1/2"
7129	1" x 3/4"	7142	2" x 1-1/2"	7156	4" x 3"
7130	1" x 1/2"	7143	2" x 1-1/4"	7157	4" x 2-1/2"
7131	1" x 3/8"	7144	2" x 1"	7158	4" x 2"

couPLING PIPE, bRASS



PART#	SIzE
7100	1/8"
7101	1/4"
7102	3/8"
7103	1/2"
7104	3/4"
7105	1"
7106	1-1/4"
7107	1-1/2"
7108	2"
7109	2-1/2"
7110	3"
7112	4"

uNIO N PIPE, bRASS



PART#	SIzE
7162	1/8"
7163	1/4"
7164	3/8"
7165	1/2"
7166	3/4"
7167	1"
7168	1-1/4"
7169	1-1/2"
7170	2"
7171	2-1/2"
7172	3"
7173	4"

ELbo W 45°, bRASS



PART#	SIzE
7174	1/8"
7175	1/4"
7176	3/8"
7177	1/2"
7178	3/4"
7179	1"
7180	1-1/4"
7181	1-1/2"
7182	2"
7183	2-1/2"
7184	3"
7185	4"

ELbo W 45° STREET, bRASS

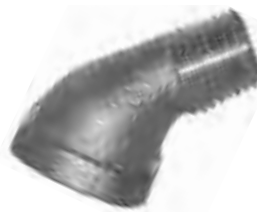

PART#	SIzE
7189	1/8"
7190	1/4"
7191	3/8"
7192	1/2"
7193	3/4"
7194	1"
7195	1-1/4"
7196	1-1/2"
7197	2"
7198	2-1/2"
7199	3"
7200	4"

ELbo W 90°, bRASS



PART#	SIzE
7204	1/8"
7205	1/4"
7206	3/8"
7207	1/2"
7208	3/4"
7209	1"
7210	1-1/4"
7211	1-1/2"
7212	2"
7213	2-1/2"
7214	3"
7216	4"

ELbo W 90° STREET, bRASS



PART#	SIzE
7247	1/8"
7248	1/4"
7249	3/8"
7250	1/2"
7251	3/4"
7252	1"
7253	1-1/4"
7254	1-1/2"
7255	2"
7256	2-1/2"
7257	3"
7258	4"

FITTINGS & couPLINGS, bRASS

**ELbo W
90° REducING,
bRASS**



PART#	SIzE	PART#	SIzE	PART#	SIzE
7220	1/4" x 1/8"	7231	1" x 3/8"	7243	2-1/2" x 2"
7221	3/8" x 1/4"	7232	1-1/4" x 1"	7244	3" x 2"
7222	3/8" x 1/8"	7233	1-1/4" x 3/4"	7245	3" x 2-1/2"
7223	1/2" x 3/8"	7234	1-1/4" x 1/2"	7246	4" x 3"
7224	1/2" x 1/4"	7236	1-1/2" x 1-1/4"		
7225	1/2" x 1/8"	7237	1/2"1-1/2"x 1"		
7226	3/4" x 1/2"	7238	1-1/2" x 3/4"		
7227	3/4" x 3/8"	7239	2" x 1-1/2"		
7228	3/4" x 1/4"	7240	2" x 1-1/4"		
7229	1" x 3/4"	7241	2" x 1"		
7230	1" x 1/2"	7242	2" x 3/4"		

**TEE - PIPE,
bRASS**



Threaded - 125 Pound.
LYNCAR Cast Brass Fittings
meet ANSI B16.15 - 1978
Specification for 125 Pound
Thread Fittings

PART#	SIzE
7259	1/8"
7260	1/4"
7261	3/8"
7262	1/2"
7263	3/4"
7264	1"
7265	1-1/4"
7266	1-1/2"
7267	2"
7268	2-1/2"
7269	3"
7270	3-1/2"
7271	4"

**cAP
bRASS**



PART#	SIzE
7404	1/8"
7405	1/4"
7406	3/8"
7407	1/2"
7408	3/4"
7409	1"
7410	1-1/4"
7411	1-1/2"
7412	2"
7413	2-1/2"
7414	3"
7416	4"

**cRo SSES PIPE,
bRASS**



PART#	SIzE
7500	1/8"
7501	1/4"
7502	3/8"
7503	1/2"
7504	3/4"
7505	1"
7506	1-1/4"
7507	1-1/2"
7508	2"

**FLo oR FLANGES,
bRASS**



PART#	SIzE
7538	1/2"
7539	3/4"
7540	1"
7541	1-1/4"
7542	1-1/2"

**ExTENSIO N
PIEcES, bRASS**



PART#	SIzE
7524	1/8"
7525	1/4"
7526	3/8"
7527	1/2"
7528	3/4"
7529	1"
7530	1-1/4"
7531	1-1/2"
7532	2"

**Lo cKNu TS
bRASS, bRASS**



PART#	SIzE
7561	1/8"
7562	1/4"
7563	3/8"
7564	1/2"
7565	3/4"
7566	1"
7567	1-1/4"
7568	1-1/2"
7569	2"

FITTINGS & COUPLINGS, BRASS

REDUCING TEES, BRASS



PART#	SIZE	PART#	SIZE	PART#	SIZE
7283	3/8" x 3/8" x 1/4"	7320	1" x 3/4" x 3/4"	7368	2" x 2" x 1/2"
7292	1/2" x 1/2" x 3/4"	7321	1" x 3/4" x 1/2"	7381	2-1/2" x 2-1/2" x 2"
7293	1/2" x 1/2" x 3/8"	7323	1" x 1/2" x 1"	7382	2-1/2" x 2-1/2" x 1-1/2"
7294	1/2" x 1/2" x 1/4"	7324	1" x 1/2" x 3/4"	7384	2-1/2" x 2-1/2" x 1"
7295	1/2" x 1/2" x 1/8"	7325	1" x 1/2" x 1/2"	7386	2-1/2" x 2-1/2" x 1/2"
7299	1/2" x 1/4" x 1/2"	7326	1" x 1/2" x 3/8"	7388	3" x 3" x 2-1/2"
7302	3/4" x 3/4" x 1"	7328	1-1/4" x 1-1/4" x 1"	7389	3" x 3" x 2"
7303	3/4" x 3/4" x 1/2"	7329	1-1/4" x 1-1/4" x 3/4"	7390	3" x 3" x 1-1/2"
7304	3/4" x 3/4" x 3/8"	7330	1-1/4" x 1-1/4" x 1/2"	7391	3" x 3" x 1-1/4"
7305	3/4" x 3/4" x 1/4"	7333	1-1/4" x 1" x 1"	7392	3" x 3" x 1"
7306	3/4" x 3/4" x 1/8"	7342	1-1/2" x 1-1/2" x 1-1/4"	7393	3" x 3" x 3/4"
7307	3/4" x 1/2" x 3/4"	7343	1-1/2" x 1-1/2" x 1"	7394	3" x 3" x 1/2"
7308	3/4" x 1/2" x 1/2"	7344	1-1/2" x 1-1/2" x 3/4"	7395	4" x 4" x 3"
7313	1" x 1" x 1-1/2"	7345	1-1/2" x 1-1/2" x 1/2"	7396	4" x 4" x 2-1/2"
7315	1" x 1" x 3/4"	7346	2" x 2" x 1-1/2"	7397	4" x 4" x 2"
7316	1" x 1" x 1/2"	7365	2" x 2" x 1-1/4"	7398	4" x 4" x 1-1/2"
7317	1" x 1" x 3/8"	7366	2" x 2" x 1"		
7319	1" x 3/4" x 1"	7367	2" x 2" x 3/4"		

BUSSING - HEX BRONZE, BRASS



PART#	SIZE	PART#	SIZE	PART#	SIZE
7436	1/4" x 1/8"	7452	1-1/4" x 3/4"	7468	2" x 1/2"
7437	3/8" x 1/4"	7453	1-1/4" x 1/2"	7472	2-1/2" x 2"
7438	3/8" x 1/8"	7454	1-1/4" x 3/8"	7473	2-1/2" x 1-1/2"
7439	1/2" x 3/8"	7455	1-1/4" x 1/4"	7474	2-1/2" x 1-1/4"
7440	1/2" x 1/4"	7456	1-1/4" x 1/8"	7475	2-1/2" x 1"
7441	1/2" x 1/8"	7457	1-1/2" x 1-1/4"	7481	3" x 2-1/2"
7442	3/4" x 1/2"	7458	1-1/2" x 1"	7482	3" x 2"
7443	3/4" x 3/8"	7459	1-1/2" x 3/4"	7483	3" x 1-1/2"
7444	3/4" x 1/4"	7460	1-1/2" x 1/2"	7484	3" x 1-1/4"
7445	3/4" x 1/8"	7461	1-1/2" x 3/8"	7485	3" x 1"
7446	1" x 3/4"	7462	1-1/2" x 1/4"	7486	3" x 3/4"
7447	1" x 1/2"	7463	1-1/2" x 1/8"	7487	3" x 1/2"
7448	1" x 3/8"	7464	2" x 1-1/2"	7489	4" x 3"
7449	1" x 1/4"	7465	2" x 1-1/4"	7490	4" x 2-1/2"
7450	1" x 1/8"	7466	2" x 1"	7491	4" x 2"
7451	1-1/4" x 1"	7467	2" x 3/4"	7492	4" x 1-1/2"

FITTINGS & couPLINGS

TEE couPLING - TEE bRASS



PART#	cWT	IPS	NPT TEE ouTLET
2935	1/2"	3/8"	1/2"
2936	3/4"	1/2"	3/4"
2937	1"	3/4"	1"
2938	3/4"	1/2"	1/2"
2939	1"	3/4"	1/2"
2940	1"	3/4"	3/4"
2941	1-1/4"	1"	3/4"
2942	1-1/4"	1"	1"
2943	1-1/2"	1-1/4"	1-1/4"
2944	--	1-1/2"	1-1/2"
2945	--	2"	1-1/2"
2946	--	2"	2"

SquARE HEAd PLUGS



PART#	SIzE
7420	1/8"
7421	1/4"
7422	3/8"
7423	1/2"
7424	3/4"
7425	1"
7426	1-1/4"
7427	1-1/2"
7428	2"
7429	2-1/2"
7430	3"
7432	4"

LoNG couPLING - IRoN



PART#	IPS	LENGTH
2908	1/2"	3-3/4"
2909	3/4"	4"
2910	1"	4-1/4"
2911	1-1/4"	4-3/4"
2912	1-1/2"	5"
2913	2"	5-3/8"

LoNG couPLING - bRASS



PART#	cWT	IPS	LENGTH
2921	1/2"	3/8"	5"
2922	3/4"	1/2"	5"
2923	1"	3/4"	5"
2924	1-1/4"	1"	5"
2925	1-1/2"	1-1/4"	5"
2926	2"	--	5"
2929	--	1-1/2"	5"
2930	--	2"	5"

TEE couPLING - IRoN



PART#	IPS	bRANcH SIzE
2914	1/2"	1/2"
2915	3/4"	3/4"

MALE x coMPRESSIoN - IRoN



PART#	TubE o.d.
2950	1/2"
2951	3/4"

SHoRT couPLING - IRoN



PART#	IPS	LENGTH
2900	1/2"	2-5/8"
2901	3/4"	2-3/4"
2902	1"	3-1/8"
2903	1-1/4"	3-1/4"
2904	1-1/2"	3-3/8"
2905	2"	3-5/8"
2906	2-1/2"	4-3/8"
2907	3"	4-3/4"

SHoRT couPLING - bRASS



PART#	cWT	IPS	LENGTH
2916	1/2"	3/8"	2-9/16"
2917	3/4"	1/2"	2-3/4"
2918	1"	3/4"	3"
2919	1-1/4"	1"	3"
2920	1-1/2"	1-1/4"	3-1/4"
2927	--	1-1/2"	3-1/2"

These couplings are intended for temporary repair.
Do not use on hot water, steam, oxygen, petroleum or similar explosive or combustible mediums.

NIPPLES - bBRASS

Each nipple is cleaned of burrs and cutting oil and manufactured in accordance with ASTM B-687. Sizes 1-1/4" through 4" continued on the next page.



1/8"

1/4"

3/8"

PART#	LENGTH
7700	CL
7701	1-1/2"
7702	2"
7703	2-1/2"
7704	3"
7705	3-1/2"
7706	4"
7707	4-1/2"
7708	5"
7709	5-1/2"
7710	6"

PART#	LENGTH
7717	CL
7718	1-1/2"
7719	2"
7720	2-1/2"
7721	3"
7722	3-1/2"
7723	4"
7724	4-1/2"
7725	5"
7726	5-1/2"
7727	6"

PART#	LENGTH
7734	CL
7735	1-1/2"
7736	2"
7737	2-1/2"
7738	3"
7739	3-1/2"
7740	4"
7741	4-1/2"
7742	5"
7743	5-1/2"
7744	6"

1/2"

3/4"

1"

PART#	LENGTH
7751	CL
7752	1-1/2"
7753	2"
7754	2-1/2"
7755	3"
7756	3-1/2"
7757	4"
7758	4-1/2"
7759	5"
7760	5-1/2"
7761	6"
7762	6-1/2"
7763	8"
7765	10"
7767	12"

PART#	LENGTH
7768	CL
7769	1-1/2"
7770	2"
7771	2-1/2"
7772	3"
7773	3-1/2"
7774	4"
7775	4-1/2"
7776	5"
7777	5-1/2"
7778	6"
7780	8"
7782	10"
7784	12"

PART#	LENGTH
7785	CL
7786	2"
7787	2-1/2"
7789	3"
7790	3-1/2"
7791	4"
7792	4-1/2"
7793	5"
7794	5-1/2"
7795	6"
7797	8"
7799	10"
7801	12"

NIPPLES - bBRASS

Each nipple is cleaned of burrs and cutting oil and manufactured in accordance with ASTM B-687.



1-1/4"

PART#	LENGTH
7802	CL
7803	2"
7804	2-1/2"
7805	3"
7806	3-1/2"
7807	4"
7808	4-1/2"
7809	5"
7810	5-1/2"
7811	6"
7813	8"
7815	10"
7817	12"

1-1/2"

PART#	LENGTH
7818	CL
7819	2"
7820	2-1/2"
7821	3"
7822	3-1/2"
7823	4"
7824	4-1/2"
7825	5"
7826	5-1/2"
7827	6"
7829	8"
7831	10"
7833	12"

2"

PART#	LENGTH
7834	CL
7835	2-1/2"
7836	3"
7837	3-1/2"
7838	4"
7839	4-1/2"
7840	5"
7841	5-1/2"
7842	6"
7844	8"
7846	10"
7848	12"

2-1/2"

PART#	LENGTH
7849	CL
7850	3"
7851	3-1/2"
7852	4"
7853	4-1/2"
7854	5"
7855	5-1/2"
7856	6"
7858	8"
7860	10"
7862	12"

3"

PART#	LENGTH
7863	CL
7864	3"
7865	3-1/2"
7866	4"
7867	4-1/2"
7868	5"
7869	5-1/2"
7870	6"
7872	8"
7874	10"
7876	12"

4"

PART#	LENGTH
7888	CL
7889	4"
7890	4-1/2"
7891	5"
7892	5-1/2"
7893	6"
7895	8"
7897	10"
7899	12"

NIPPLE boxes

NIPPLE boxes



- Holds 1/2" CL thru 6" nipples
- Fold away handle
- Epoxy coated steel
- Light weight yet strong

PART#	SIzE	HoLdS
3080	1/2"	77
3081	3/4"	66
3082	1"	50
3083	1-1/4"	40
3084	1-1/2"	30
3085	2"	27

FITTING ToTE TRAY



- Excellent for copper fittings
- 18 gauge
- 20" x 10" x 5"
- Fold away handle
- Epoxy coated steel
- With 8 compartments

PART#	dEScRIPTIoN
3088	Fitting tote tray

NIPPLE box - 1/2" & 3/4" (coMbo)



- Holds both 1/2" and 3/4" nipples
- Holds (39) 1/2" CL thru 6"
- Holds (33) 3/4" CL thru 6"
- Fold away handle
- Epoxy coated steel

PART#	dEScRIPTIoN
3091	1/2" and 3/4"

cHRoME PLATED bRASS FITTINGS

cAP - cHRoME



PART#	SIzE	PART#	SIzE
7405c	1/4"	7409c	1"
7406c	3/8"	7410c	1-1/4"
7407c	1/2"	7411c	1-1/2"
7408c	3/4"	7412c	2"

couPLING - PIPE cP



PART#	SIzE
7101c	1/4"
7102c	3/8"
7103c	1/2"
7104c	3/4"
7105c	1"
7106c	1-1/4"
7107c	1-1/2"
7108c	2"

ELboW - 90° cP



PART#	SIzE
7205c	1/4"
7206c	3/8"
7207c	1/2"
7208c	3/4"
7209c	1"
7210c	1-1/4"
7211c	1-1/2"
7212c	2"

couPLING - REducING



PART#	SIzE
7123c	1/2" x 3/8"
7126c	3/4" x 1/2"

ELboW - 90° REducING cP



PART#	SIzE
7223c	1/2" x 3/8"
7226c	3/4" x 1/2"

uNIoN - PIPE cP



PART#	SIzE
7163c	1/4"
7164c	3/8"
7165c	1/2"
7166c	3/4"
7167c	1"
7168c	1-1/4"
7169c	1-1/2"
7170c	2"

ELboW 90° STREET cP



PART#	SIzE
7248c	1/4"
7249c	3/8"
7250c	1/2"
7251c	3/4"
7252c	1"
7253c	1-1/4"
7254c	1-1/2"
7255c	2"

CHROME PLATED BRASS FITTINGS

ELBoW 45° cP



PART#	SIzE
7175c	1/4"
7176c	3/8"
7177c	1/2"
7178c	3/4"
7179c	1"
7180c	1-1/4"
7181c	1-1/2"
7182c	2"

TEE - PIPE cP



PART#	SIzE
7260c	1/4"
7261c	3/8"
7262c	1/2"
7263c	3/4"
7264c	1"
7265c	1-1/4"
7266c	1-1/2"
7267c	2"

ELboW - 45° STREET cP



PART#	SIzE
7192c	1/2"

REducING TEES cP



PART#	SIzE
7203c	3/4" x 1/2"

PLuGS



PART#	SIzE
7421c	1/4"
7422c	3/8"
7423c	1/2"
7424c	3/4"
7425c	1"
7426c	1-1/4"
7427c	1-1/2"
7428c	2"

buSHING - HEx cP



PART#	SIzE
7437c	3/8" x 1/4"
7439c	1/2" x 3/8"
7440c	1/2" x 1/4"
7442c	3/4" x 1/2"
7446c	1" x 3/4"
7451c	1-1/4" x 1"

cHRoME PLATED bRASS NIPPLES

cHRoME PLATED bRASS NIPPLES



1/4"

3/8"

1/2"

3/4"

PART#	LENGTH	PART#	LENGTH	PART#	LENGTH	PART#	LENGTH
7717c	CL	7734c	CL	7751c	CL	7768c	CL
7718c	1-1/2"	7735c	1-1/2"	7752c	1-1/2"	7769c	1-1/2"
7719c	2"	7736c	2"	7753c	2"	7770c	2"
7720c	2-1/2"	7737c	2-1/2"	7754c	2-1/2"	7771c	2-1/2"
7721c	3"	7738c	3"	7755c	3"	7772c	3"
7722c	3-1/2"	7739c	3-1/2"	7756c	3-1/2"	7773c	3-1/2"
7723c	4"	7740c	4"	7757c	4"	7774c	4"
7724c	4-1/2"	7741c	4-1/2"	7758c	4-1/2"	7775c	4-1/2"
7725c	5"	7742c	5"	7759c	5"	7776c	5"
7726c	5-1/2"	7743c	5-1/2"	7760c	5-1/2"	7777c	5-1/2"
7727c	6"	7744c	6"	7761c	6"	7778c	6"

1"

1-1/4"

1-1/2"

2"

PART#	LENGTH	PART#	LENGTH	PART#	LENGTH	PART#	LENGTH
7785c	CL	7802c	CL	7818c	CL	7834c	CL
7786c	2"	7803c	2"	7819c	2"	7835c	2-1/2"
7787c	2-1/2"	7804c	2-1/2"	7820c	2-1/2"	7836c	3"
7789c	3"	7805c	3"	7821c	3"	7837c	3-1/2"
7790c	3-1/2"	7806c	3-1/2"	7822c	3-1/2"	7838c	4"
7791c	4"	7807c	4"	7823c	4"	7839c	4-1/2"
7792c	4-1/2"	7808c	4-1/2"	7824c	4-1/2"	7840c	5"
7793c	5"	7809c	5"	7825c	5"	7841c	5-1/2"
7794c	5-1/2"	7810c	5-1/2"	7826c	5-1/2"	7842c	6"
7795c	6"	7811c	6"	7827c	6"	7844c	8"
7797c	8"	7813c	8"	7829c	8"	7846c	10"
7799c	10"	7815c	10"	7831c	10"	7848c	12"
7801c	12"	7817c	12"	7833c	12"		

HANGERS & FITTINGS

bRASS FLARE & cOMPRESSIoN FITTINGS

FLARE - 39 SERIES PLUGS



PART#	SIzE
7-393	3/16"
7-394	1/4"
7-395	5/16"
7-396	3/8"
7-398	1/2"

FLARE - 41Sc SWIVEL vALvE cONNEcT



PART#	SIzE
7-41Sc4	1/4"
7-41Sc6	3/8"
7-41Sc8	1/2"

FLARE - 40 SERIES cAP NuTS



PART#	SIzE
7-403	3/16"
7-404	1/4"
7-405	5/16"
7-406	3/8"
7-408	1/2"

FLARE - 41SHN SPAcE HEATER NuT



9/16" X 24 Thread

PART#	SIzE
7-41SHN	3/8"

FLARE - 41F SERIES - FoRGEd SHoRT NuT



PART#	SIzE
7-41F3	3/16"
7-41F4	1/4"
7-41F5	5/16"
7-41F6	3/8"
7-41F8	1/2"
7-41F10	5/8"

FLARE - 41L SERIES LoNG NuT



PART#	SIzE
7-41L3	1/8"
7-41L4	3/16"
7-41L5	1/4"
7-41L6	5/16"
7-41L8	3/8"
7-41L10	3/8" x 1/4"

FLARE - 42 SERIES uNIoNS



PART#	SIzE
7-423	3/16"
7-424	1/4"
7-425	5/16"
7-426	3/8"
7-4264	3/8" x 1/4"
7-428	1/2"
7-4284	1/2" x 1/4"
7-4286	1/2" x 3/8"
7-4210	5/8"

FLARE - 44 SERIES TEES



PART#	SIzE
7-444	1/4"
7-445	5/16"
7-446	3/8"
7-4464	3/8" x 1/4"
7-4468	3/8" x 1/2"
7-448	1/2"
7-4484	1/2" x 1/4"
7-4486	1/2" x 3/8"
7-4410	5/8"

bBRASS FLARE & cOMPRESSIoN FITTINGS

**FLARE - 41S SERIES
SHoRT NuT**



PART#	SIzE
7-41S2	1/8"
7-41S3	3/16"
7-41S4	1/4"
7-41S5	5/16"
7-41S6	3/8"
7-41S64	3/8" x 1/4"
7-41S7	7/16"
7-41S8	1/2"

**FLARE - 45 SERIES
x MIP TEES**



PART#	SIzE
7-4564	3/8" x 1/4"
7-4566	3/8" x 3/8"
7-4568	3/8" x 1/2"

**FLARE - 55 SERIES
90° ELbo W**



PART#	SIzE
7-554	1/4"
7-555	5/16"
7-558	1/2"
7-5510	5/8"

**FLARE - 52 SERIES
cRo SS**



PART#	SIzE
7-526	3/8"
7-528	1/2"

**FLARE - 50 SERIES x FIP
90° ELbo W**



PART#	SIzE
7-5066	3/8"
7-5068	3/8" x 1/2"
7-50612	3/8" x 3/4"
7-5084	1/2" x 1/4"
7-5086	1/2" x 3/8"
7-5088	1/2"
7-50812	1/2" x 3/4"

**FLARE - 49 SERIES x MIP
90° ELbo W**



PART#	SIzE
7-4942	1/4" x 1/8"
7-4944	1/4"
7-4954	5/16" x 1/4"
7-4964	3/8" x 1/4"
7-4966	3/8"
7-4968	3/8" x 1/2"
7-4984	1/2" x 1/4"
7-4986	1/2" x 3/8"
7-4988	1/2"
7-49108	5/8" x 1/2"

Two piece: body and nut. Straights and shapes are manufactured from CA360, CA345 or CA377 brass. 45° Flare. Heavy duty flare fittings are manufactured to SAE specifications. Compatible with copper, brass, aluminum and steel hydraulic tubing that can be flared. Used on low, medium and high pressure lines under the most adverse conditions. Fair vibration resistance. The long nut offers greater support. Temperature range from -65° to +250° F.

HANGERS & FITTINGS

BRASS FLARE & COMPRESSIoN FITTINGS

**FLARE - 46
SERIES
x FIP
couPLING**



PART#	SIzE
7-4642	1/4" x 1/8"
7-4644	1/4"
7-4654	5/16" x 1/4"
7-4662	3/8" x 1/8"
7-4666	3/8"
7-4668	3/8" x 1/2"
7-4684	1/2" x 1/4"
7-4686	1/2" x 3/8"
7-4688	1/2"
7-46812	1/2" x 3/4"
7-46108	5/8" x 1/2"
7-461012	5/8" x 3/4"
7-461212	3/4" x 3/4"

**coMPRESSIoN
- 62 SERIES
uNIoN**



PART#	SIzE
7-622	1/8"
7-623	3/16"
7-624	1/4"
7-6242	1/4" x 1/8"
7-625	5/16"
7-6254	5/16" x 1/4"
7-626	3/8"
7-6264	3/8" x 1/4"
7-628	1/2"
7-6286	1/2" x 3/8"
7-6210	5/8"
7-62106	5/8" x 3/8"
7-62108	5/8" x 1/2"
7-6214	7/8"

**FLARE - 48
SERIES
x MIP
couPLING**



PART#	SIzE
7-4842	1/4" x 1/8"
7-4844	1/4"
7-4846	1/4" x 3/8"
7-4848	1/4" x 1/2"
7-4854	5/16" x 1/4"
7-4856	5/16" x 3/8"
7-4864	3/8" x 1/4"
7-4866	3/8"
7-4868	3/8" x 1/2"
7-48612	3/8" x 3/4"
7-4884	1/2" x 1/4"
7-4886	1/2" x 3/8"
7-4888	1/2" x 1/2"
7-48108	5/8" x 1/2"
7-481012	5/8" x 3/4"
7-48812	1/2" x 3/4"

**coMPRESSIoN
- 66 SERIES x
FIP couPLING**



PART#	SIzE
7-6642	1/4" x 1/8"
7-6644	1/4"
7-6648	1/4" x 1/2"
7-6654	5/16" x 1/4"
7-6662	3/8" x 1/8"
7-6664	3/8" x 1/4"
7-6666	3/8"
7-6668	3/8" x 1/2"
7-6684	1/2" x 1/4"
7-6686	1/2" x 3/8"
7-6688	1/2"
7-66108	5/8" x 1/2"

**coMPRESSIoN
60 SERIES
SLEEvE**



PART#	SIzE
7-602	1/8"
7-603	3/16"
7-604	1/4"
7-605	5/16"
7-606	3/8"
7-607	7/16"
7-608	1/2"

**coMPRESSIoN
- 61 SERIES
SHoRT NuT**



PART#	SIzE
7-613	3/16"
7-614	1/4"
7-615	5/16"
7-616	3/8"
7-618	1/2"
7-6110	5/8"

**coMPRESSIoN
64 SERIES TEE**



PART#	SIzE
7-643	3/16"
7-644	1/4"
7-645	5/16"
7-646	3/8"
7-648	1/2"
7-6410	5/8"

- Three piece unit: body, nut and sleeve.
- Straights and shapes are manufactured from CA360, CA345, CA377.
- Compatible with copper, brass, aluminum and thermoplastic tubing. (Thermoplastic tubing requires the use of a brass insert for support.)
- Low pressure air, oil, water and gas up to a maximum pressure of 400 psi.
- Fair vibration resistance
- The long nut can be used for greater vibration application.

bRASS FLARE & coMPRESSIoN FITTINGS

coMPRESSIoN - 65 SERIES 90° ELboW



PART#	SIzE
7-653	3/16"
7-654	1/4"
7-656	3/8"
7-6564	3/8" x 1/4"
7-658	1/2"
7-6510	5/8"
7-65106	5/8" x 3/8"

coMPRESSIoN - 61c SERIES cAP



PART#	SIzE
7-61c4	1/4"
7-61c6	3/8"

coMPRESSIoN - 68 SERIES x MIP couPLING



PART#	SIzE	PART#	SIzE
7-6822	1/8"	7-6866	3/8"
7-6842	1/4" x 1/8"	7-6868	3/8" x 1/2"
7-6844	1/4"	7-6884	1/2" x 1/4"
7-6846	1/4" x 3/8"	7-6886	1/2" x 3/8"
7-6848	1/4" x 1/2"	7-6888	1/2"
7-6852	5/16" x 1/8"	7-68106	5/8" x 3/8"
7-6854	5/16" x 1/4"	7-68108	5/8" x 1/2"
7-6862	3/8" x 1/8"	7-681012	5/8" x 3/4"
7-6864	3/8" x 1/4"	7-681412	7/8" x 3/4"

coMPRESSIoN - 69 SERIES x MIP 90° ELboW



PART#	SIzE	PART#	SIzE
7-6944	1/4"	7-6968	3/8" x 1/2"
7-6946	1/4" x 3/8"	7-6984	1/2" x 1/4"
7-6948	1/4" x 1/2"	7-6986	1/2" x 3/8"
7-6952	5/16" x 1/8"	7-6988	1/2"
7-6954	5/16" x 1/4"	7-69812	1/2" x 3/4"
7-6962	3/8" x 1/8"	7-69106	5/8" x 3/8"
7-6964	3/8" x 1/4"	7-69108	5/8" x 1/2"
7-6966	3/8"		

coMPRESSIoN - 70 SERIES x FIP 90° ELboW



PART#	SIzE	PART#	SIzE
7-7042	1/4" x 1/8"	7-7066	3/8"
7-7044	1/4"	7-7068	3/8" x 1/2"
7-7062	3/8" x 1/8"	7-7086	1/2" x 3/8"
7-7064	3/8" x 1/4"	7-7088	1/2"

SOFT TOUCH PEX TOOLS

PEX CRIMP TOOL - 12" HaNDLE



- For 1/2" or 3/4" PEX pipe sizes
- Crimps conform to A.S.T.M. specifications
- Tools are supplied with a go/no-go gauge
- Tool length is 12" ("S" Length) and weighs 3 lbs.
- The Soft-Touch short handle tools are well suited for manifold and difficult access areas
- High mechanical advantage in a compact design make this product the plumbing contractor's first choice
- Made in USA

PaRT#	DESCRIPTION
-------	-------------

- | | |
|---------|--------------|
| 9202STS | For 1/2" PEX |
| 9203STS | For 3/4" PEX |

PEX CRIMP TOOL - 16" HaNDLE



- For 1/2" or 3/4" PEX pipe sizes
- Crimps conform to A.S.T.M. specifications
- Tools are supplied with a go/no-go gauge
- Tool length is 16" ("M" Length) and weighs 4 lbs.
- The Soft-Touch medium handle tools are considered the standard of the industry
- The longer length on this tool promotes productivity and minimizes user fatigue
- Made in USA

PaRT#	DESCRIPTION
-------	-------------

- | | |
|---------|--------------|
| 9202STM | For 1/2" PEX |
| 9203STM | For 3/4" PEX |
| 9204STM | For 1" PEX |

PEX CRIMP TOOL - 19" HaNDLE



- For 1/2" or 3/4" PEX pipe sizes
- Crimps conform to A.S.T.M. specifications
- Tools are supplied with a go/no-go gauge
- Tool length is 19" ("L" Length) and weighs 4 lbs.
- The Soft-Touch long handle tools provide maximum reach with the lowest crimp loads
- Made in USA

PaRT#	DESCRIPTION
-------	-------------

- | | |
|---------|--------------|
| 9202STL | For 1/2" PEX |
| 9203STL | For 3/4" PEX |

PEX CRIMP TOOL - DUaL 1/2" & 3/4" RINgS



- Dual Tool for 1/2" & 3/4" PEX pipe sizes
- Crimps conform to A.S.T.M. specifications
- Tools are supplied with a go/no-go gauge
- The Soft-Touch medium handle tools are considered the standard of the industry
- The longer length on this tool promotes productivity and minimizes user fatigue
- Made in USA

PaRT#	DESCRIPTION
-------	-------------

- | | |
|---------|-----------------------------|
| 9206STS | 12" handle 1/2" & 3/4" tool |
| 9205STM | 16" handle 1/2" & 3/4" tool |
| 9205STL | 19" handle 1/2" & 3/4" tool |

LyNCaRS PEX TOOLS

LyNCaR PEX CRIMP TOOL



- LYNCAR'S soft-grip mid-short handle tools are the best value tool for PEX manifold work, also ideal for difficult access areas
- Compact design and high mechanical leverage make this tool the service plumber's first choice
- For 1/2" or 3/4" PEX pipe sizes
- Crimps conform to A.S.T.M. specifications
- Supplied with a go/no-go gauge

PaRT#	HaNDLE SIZE	DESCRIPTIOn
9301	14"	For 1/2" PEX rings
9302	14"	For 3/4" PEX rings
9303	18"	For 1/2" PEX rings
9304	18"	For 3/4" PEX rings

LyNCaR COMBO PEX CRIMP TOOL - 1/2" & 3/4"



- LYNCAR'S soft-grip long handle tools are considered the best value in PEX crimp tools
- The longer handle length is better suited for productivity and minimizes user fatigue
- Combo crimp head for 1/2" & 3/4" PEX pipe sizes
- Supplied with a go/no-go gauge
- 14" handle
- Crimps conform to A.S.T.M. specifications

PaRT#	DESCRIPTIOn
9309	1/2" & 3/4" combo

RIgHT aNgLE SOFT TOUCH CRIMP TOOL



- 12" long
- 1/2" or 3/4" head
- Provides a new level of access in confined crimp locations
- Handles can be opened unobstructed for overhead in between joist crimping, in a cabinet or standing over a pipe which require a flush crimp to any surface
- Crimps to ASTM F1807 specifications
- Crimp head is tilted to 90 degrees
- Toggle action assures all rings are crimped to spec
- Supplied with a go/no go size gauge

PaRT#	DESCRIPTIOn
9202STS90a	1/2" head
9203STS90a	3/4" head

POCKET CRIMPER



- Crimps standard black copper PEX rings
- Preferred by professionals
- Use for 3/8", 1/2" and 3/4"
- Includes tool, pouch and a go/no go size gauge
- 6 pack is a counter display for quick impulse sales

PaRT#	DESCRIPTIOn
9312	Pocket crimper

PEX TOOLS

MIL 3 aNgLE CRIMPMaKER TOOL



- Easy-to-use PEX MIL 3 tools
- Recognized by plumbers as a the premium PEX crimping angle tool
- Compact, can reach into tight spaces
- MIL 3 PEX tools ensure a tight PEX crimp every time
- Made in the U.S.A
- Supplied with a go/no-go gauge

MIL 3 aNgLE CRIMPMaKER 1"



- Easy-to-use PEX MIL 3 tools
- The only 1" Angle Pex Tool available
- Compact, can reach into tight spaces
- MIL 3 PEX tools ensure a tight PEX crimp every time
- Made in the U.S.A
- Supplied with a go/no-go gauge

PaRT#	DESCRIPTION
9321	1/2" PEX rings
9322	3/4" PEX rings

PaRT#	DESCRIPTION
9323	1" PEX rings

aNgLED HEaD COMPaCT CRIMP TOOL



- The LYNCAR SoftCrimp **part#9310** & **part#9311** are professional quality heavy-duty crimpers that have an "open-stop" for one handed crimping
- The angled head design make it easily used in all tight spots
- Available for crimp ring size 1/2" and 3/4"
- Made in the U.S.A
- Supplied with a go/no-go gauge

PaRT#	DESCRIPTION
9310	For 1/2" PEX rings
9311	For 3/4" PEX rings

LyNCaR PEx CRIMP TOOL 1"



- LYNCAR'S Soft-Grip mid-short handle tools are the best value tool for PEX manifold work, also ideal for difficult access areas
- Compact design and high mechanical leverage make this tool the service plumber's first choice
- Crimps conform to A.S.T.M. specifications
- Made in the U.S.A
- Supplied with a go/no-go gauge

PaRT#	HaNDLE SIZE	DESCRIPTION
93071	15"	For 1" PEX Rings

PLUMBER'S TOOLS

PEX TOOLS

LyNCaR SSC PEX "CLINCH CLaMP"
RaTCHET TOOL

- LYNCAR'S SSC style clamp tool makes connections for PEX Tubing with the SSC style clamps of different sizes
- This SSC style PEX Tool is gaining in popularity due to its ease of use
- Covers 5 sizes from 3/8" to 1" SSC PEX Clamp Ring sizes
- Crimps conform to A.S.T.M. specifications
- Tool length is 19" ("L" Length) and weighs 4 lbs.
- Professional Model
- Built for every day use by the construction Plumber
- More comfortable hand grip and a robust crimping mechanism for long tool life.

PaRT#	DESCRIPTION
9308	Contractor grade blister packaged
9308P	Professional model heavy duty

PEX TOOL CLINCH CLaMP TOOL



- LYNCAR'S unique 3 handle design
- Effective for all size stainless steel clamps (3/8", 1/2", 3/4" and 1")
- Tool calibration gauge included
- Meets ASTM F-2098 standards
- Ratchet mechanism, compact design

PaRT#	DESCRIPTION
93083	Clinch clamp tool with third handle design

PEX TOOL HD FOR SS RING, ONE HaND LED LIgHT



- PEX tool for SSC type clamps
- One hand operation
- LED light confirms a good clamp
- Spring loaded handle for easy operation

PaRT#	DESCRIPTION
9313	PEX tool H.D., with LED light

PEX TOOLS

L

EaSy SHEaR By LyNCaR



- Available exclusively from LYNCAR
- PEX rings are great - but when they have to be removed they become one of the biggest challenges a plumber faces
- Saves all 1/2" and 3/4" PEX fittings
- Saves you TIME and MONEY
- Easy to use even in difficult places
- Needs no adjustments
- High quality replaceable blades
- Will not damage your pipe or fittings
- Tool to be used on copper rings only
- Canadian patent#CA 2274034
- US patent#6,769,181

PaRT#	DESCRIPTION
7402ES	For 1/2" PEX rings
7403ES	For 3/4" PEX rings
7402B	Replacement blade

PEX CLaMP BUSTER



- Removes the SSC style fitting clamps in order to remove the PEX tubing
- Includes the socket wrench
- Works on all sizes of SSC style clamps

PaRT#	DESCRIPTION
9308RT	Clamp removal tool

PEX RING CUTTER



- A fitting recovery tool that does not change sealing surfaces
- Fits all PEX pipe sizes
- Cutting blade will only penetrate the PEX pipe
- No fitting damage with this tool
- Two cuts on the ring will allow the user to reclaim the fitting
- Approx 8" long

PaRT#	DESCRIPTION
7407ES	PEX ring remover, USA made
9315	PEX ring remover, LYNCAR model

PEX TOOL COMPOSITE HaNDLE KIT



- LYNCAR'S composite handle crimp tool for 3/8", 1/2", 3/4" and 1" PEX copper rings
- This unique tool has built-in jaws for 1/2" and 1" PEX copper rings
- The 1" cavity is designed to accept quick release interchangeable dies for 3/4" PEX copper rings

PaRT#	DESCRIPTION
9314	Composite handle PEX tool

PLUMBER'S TOOLS

PEX TOOLS

aBS SUPERPRO PREMIUM CUTTER



- Premium blade cuts ABS & PVC
- Easy one hand operation
- Cuts all types of plastic pipe including ABS
- Blister packaged
- Replaceable stainless steel blade

PaRT#	DESCRIPTION
4683	Cutter heavy duty to 2" pipe
4683B	Blade

aBS HEaVY DUTY CUTTER



- Heavy duty cutting blade
- Cuts all types of plastic pipe
- Heavy duty steel construction
- Replaceable stainless steel blade

PaRT#	DESCRIPTION
4682	Cutter heavy duty to 2" pipe
4682B	Blade

PvC PIPE CUTTER



- | | |
|----------------------|-------------------------|
| part# 4657 | part# 4658 |
| - 5 Step Action | - 3 Step Action |
| - Carbon steel blade | - Stainless Steel Blade |

- part#4676**
- PVC & ABS Pipe
 - Stainless Steel blade and ratchet

PaRT#	DESCRIPTION
4657	Complete, cuts up to 1-1/4" plastic
4657B	Blade for part#4657
4658	Complete, cuts up to 1" Plastic
4658B	Blade for part#4658
4676	Complete, premium, cuts up to 1-1/4" CPVC
4676B	Blade for part#4676

PROFESSIONaL PEX CUTTER 1-1/4"



- For cutting up to 1-1/4" soft pipe & hose
- Large blade & mouth
- Spring open & close for easy use

PaRT#	DESCRIPTION
4668P	PEX cutter
4668PB	Replacement blade

PEX CUTTER



- For cutting up to 1-1/4" soft pipe and hose
- ABS Body

PaRT#	DESCRIPTION
4668	PEX cutter
4668B	Replacement blade

PLUMBERS TOOLS

L

MagNETIC TELESCOPING INSPECTION MIRROR



- Blister packed
- Mirror is 4 cm
- Magnet can hold up to 1 lb
- Telescope extends to 24"

LED TELESCOPIC LIGHT INSPECTION MIRROR



- Blister packed
- Turns on when extended and off when returned to the closed position
- Telescope extends up to 7"

PaRT#	DESCRIPTION
4914	Inspection mirror

PaRT#	DESCRIPTION
4915	Professional inspection mirror with LED light

FLExIBLE MagNET PICK UP TOOL



- Poly bag display
- Magnet & flexible
- Comfort grip handle
- 24" long cable
- 2 kg magnet

TELESCOPING wHITE LIgHT LED & MagNET TOOL



- Blister packed
- Illuminates from the front and from the side
- Turns on when extended and off when returned to the closed position
- Magnet will hold up to 1 lb
- Telescope extends up to 24"

PaRT#	DESCRIPTION
4916	2 kg magnet pick up tool

PaRT#	DESCRIPTION
4920	Telescoping white light LED

PLUMBER'S TOOLS

FITTING BRUSHES

PREMIUM QUALITY FITTING BRUSH



- Consider our premium fitting brush when making your selection
- The highest quality, finest fitting brush available! spring tempered stainless steel wire bristles
- Precision trimmed to ensure maximum contact of the bristle ends and cutting edges
- Interlaced double spiral construction
- Quadruple galvanized steel stems
- Double spiral / double stem stainless steel wire (4 wires)
- Brush bristles are twisted between four stem wires with two layers of bristles
- Each layer is perpendicular to the other

PaRT#	DESCRIPTION
5126	1/2"
5128	3/4"
5130	1"
5131	1-1/4"
5132	1-1/2"
5133	2"

STANDARD QUALITY FITTING BRUSH



- High carbon crimp steel bristles
- Single spiral / single stem (2 wires)
- Brush bristles are twisted between two stem wires with a single wire on each side

PaRT#	DESCRIPTION
5114	1/2"
5116	3/4"
5118	1"
5119	1-1/4"
5120	1-1/2"
5121	2"

OPEN MESH CLOTH - PLUMBERS



- 180 grit
- Aluminum oxide
- Resin bond
- Boxed

PaRT#	DESCRIPTION
3108	5 yd box
3109	10 yd box

SAND CLOTH - PLUMBERS



- Specially formulated for use in preparing copper fittings and tubing for soldering
- Box packaged

PaRT#	DESCRIPTION
3103	5 yd box
3102	10 yd box
3105	25 yd box

PLUMBERS TOOLS

4 IN 1 BRUSH



- High carbon crimp steel bristles

PaRT#	DESCRIPTION
5150	1/2" & 3/4" fitting & tube brush

PROFESSIONAL FAUCET RESEATER KIT



- KIT INCLUDES:
- 4- Hardened steel cutters for various size faucets
 - 1- Guide cone
 - 4- Faucet washer
 - 1- Solid brass screw
 - 1- Long shaft for tub & showers

PaRT#	DESCRIPTION
12844P	Reseater tool

FOUNTAIN 2-IN-1 WRENCH



- Tightens or loosens cartridge retaining bushing
- Prevents bushing thread damage which causes leaks

PaRT#	DESCRIPTION
7047	Key for bubblers

WRENCH - TELESCOPING BASIN



- Extends from 9" to 16"
- Swivel jaw with spring

PaRT#	DESCRIPTION
4573	Extends 9" to 16"

O-RING PICK



- O-ring pick for removal of washers & o-rings
- 18ga wire

PaRT#	DESCRIPTION
5200	O-ring pick

WRENCH - REGULAR BASIN



- For use on basin nuts, ballcocks & flush valves
- Cadmium plated
- Jaw has springs
- Swivel head operates right or left

PaRT#	DESCRIPTION
4574	11" wrench
4590	15" wrench

PLUMBERS TOOLS

wRENCH - TUB & SHOWER vaLVE



- 5 piece set of wrenches with wire bar
- Total 10 sizes: 21/31", 27/32", 29/32", 31/32", 1-1/32", 1-3/32", 1-5/32", 1-9/32", 1-11/32", 1-7/16"
- For installing or removing recessed valve stems

PaRT#	DESCRIPTION
5300	Wrench - tub & shower valve

CLEaNOT PLUG wRENCH



- This unique tool fits either slotted or square countersunk cleanout plugs
- Strong, malleable iron

PaRT#	DESCRIPTION
4567	Cleanout plug wrench

BIBB SEaT TOOLS



- Straight and angled models
- For all faucet seats
- Cadmium plated
- Heat treated

PaRT#	DESCRIPTION
4563	Square x Hex x Straight
4564	Tapered - Angled

BIBB SEaT TOOL SET



- SET INCLUDES:
- 1- 3/8" x 7/16" ratcheting box wrench
 - 1- Small hex/large hex tapered bibb seat tool
 - 1- Small square/large square no taper bibb seat tool

PaRT#	DESCRIPTION
4568	Bibb seat tool set

CaNaDIaN STyLE BIBB SEaT TOOL



- For all faucet seats
- Cadmium plated
- Heat treated
- 6 Step - Angled

PaRT#	DESCRIPTION
4561	Canadian style bibb seat tool

BIBB SEaT TOOL, THREaDED ENDS, PROFESSIONaL

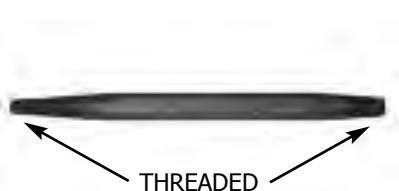

- Left hand threads
- Install and remove faucet seats
- Grabs seat when inside surface is corroded
- 6-1/2" long
- Black finished
- Carded

PaRT#	DESCRIPTION
4566	Bibb seat tool

PLUMBERS TOOLS

EaSy OUT TOOL FOR SLOaN FLUSHMaTE CaRTRIDgE



- Fast, heavy duty
- Easy in- easy out
- Eliminate broken cartridges and skinned knuckles
- The original easy-out SLOAN flushmate cartridge extractor tool

PaRT#	DESCRIPTION
10138	Easy out tool for cartridge OEM ref#ST100500

Key - SILLCOCK



- Die Cast

PaRT#	DESCRIPTION
1699	1/4" key
1700	5/16" key

Key - HEaTER FURNaCE LOg LIgHTER



- Die Cast
- Stem length: 10"

PaRT#	DESCRIPTION
1706	1/4"
1707	5/16"

Key - FOUR way



- Fits stopcocks, sillcocks and valves
- Sizes are 1/4" to 9/32" and 5/16" to 11/32"
- Precision machined plated steel

PaRT#	DESCRIPTION
1701	Key - four way

wRENCH - 3 IN 1 RaDIaTOR vaLvE



- Inserts
- Rethreads
- Extracts

PaRT#	DESCRIPTION
4947	Chrome plated brass

PaRTITION STOP Key - BRaSS



- Partition or access keys
- 4 lengths available
- Machined brass

PaRT#	DESCRIPTION
1486	3" long
1487	6" long
1488	9" long
1489	12" long

wRENCH - RaDIaTOR SPUD



- 6 tiered wrench 1/2" - 2"
- Cast aluminum

PaRT#	DESCRIPTION
4558	Spud wrench

PLUMBERS TOOLS

wRENCH w aTER HEaTER ELEMENT



- Removes water heater elements
- Heavy duty construction for 1-1/2" elements

PaRT#	DESCRIPTION
4946	Wrench water heater element

DUMBELL wRENCH - DIy



- Import, D.I.Y. grade
- Sorry no guarantee

PaRT#	DESCRIPTION
4556	Dumbell wrench

SMaRT DUMBELL



- Installs or removes drains without crossbars (KOHLER, AMERICAN STANDARD)
- Heavy duty die-cast aluminum finishes
- Either a crescent wrench or large phillips screwdriver can be used to turn the tool
- Saves time, money and aggravation

US made, Contractor grade, Life Time guarantee

PaRT#	DESCRIPTION
4554	Smart dumbell

wRENCH - SPUD



- For slip nuts, lock nuts and strainer nuts
- 10" non adjusting, 1" to 3" capacity
- One piece head treated forging

PaRT#	DESCRIPTION
4570	Wrench - spud

wRENCH - aDjUSTaBLE SPUD



- 10" length
- 1" to 3" capacity
- For slip nuts, locknuts and strainer nuts

PaRT#	DESCRIPTION
4571	Wrench - adjustable spud

wRENCH - INTERNaL SPUD



- A must to install or remove urinal and closet spud, waste and overflows, 4" capacity
- Cushioned grip

PaRT#	DESCRIPTION
4562	Wrench - internal spud

PLUMBERS TOOLS

QUICK NUTCRACKER™



- Patent Number 4,365,413
- Quickly removes corroded 1/2" zinc locknuts from faucet shanks. Heat treated cutter blades
- Ball thrust bearings
- Durable black oxide finish
- Will work on faucet shanks with only three threads showing
- For use on:
 - 1/2" shank single basin faucet
 - 1/2" shank centres
 - 1/2" shank kitchen faucets

PaRT#	DESCRIPTION
7000	QUICK NUTCRACKER™

MOEN® STEM aND CaRTRIDgE PULLER



- Removes MOEN® stems and MOEN® cartridges from faucets and shower valves
- Removes brass cartridges
- Removes brass stems
- Removes plastic stems & cartridges
- Precision made
- High quality steel components
- One piece construction
- Easy to use

PaRT#	DESCRIPTION
7040	MOEN stem & cartridge puller

EaSy-CUT jaws



- EASY-CUT JAWS
- Is a quality professionally engineered tool
 - Has a hardened steel hex end that fits into any drill chuck
 - Has a built-in spring loaded patented safety chip-guard
 - Uses a heat treated bi-metal cutter that cuts through brass, steel and plastic faucet mounting nuts
 - Works on all faucet brands that have 1/2" water supply shanks

PaRT#	DESCRIPTION
7018	Easycut

PIPE PLUG



- For copper water pipe 1/2" to 2-1/2" diameter
- Perfect for residential, commercial, and industrial plumbing & contracting
- Cut-away pipe shows the pipe plug expanded inside the pipe
- Pipe plug allows leaky valves to be replaced & other pipe modifications made with the minimum of downtime and inconvenience! Pipe plug stops the flow of water so repairs can be made fast and easy
- No need for a separate rod for each pipe size.
- Changing from one pipe size to another is quick and simple. All of the rubber plugs & washers are nested together and secured in a convenient storage tube. Using a combination of standard fittings, the down time can be drastically reduced which allows you to quickly move on to the next job.
- Each kit includes: storage tube, rod(s) with tightening handle, adjustable stop rubber plug set, full instructions

PaRT#	DESCRIPTION
59550	Pipe plug mini, 1, 3/4, 1/2"
59555	1/2, 3/4, 1, 1-1/4, 1-1/2, 2, 2-1/2"

PLUMBERS TOOLS

BIg yaNK HaNDLE PULLER



- Removes large and small handles
- Economical yet tough
- One piece forged drive bracket
- 4" bracket width
- 5" gripper fingers

PaRT#	DESCRIPTION
4659	Big yank handle puller

BIg yaNK SR.™ HaNDLE PULLER



- The only handle puller that grips faucet handles with 3 fingers
- One piece forged drive bracket
- Notches in bracket keep fingers from sliding apart
- Engineered for the professional
- 5" gripper fingers

PaRT#	DESCRIPTION
4659SR	Big yank sr.™ handle puller

xPULLER - IMPaCT HaNDLE



- Sliding impact handle assists in breaking free troublesome handles.

PaRT#	DESCRIPTION
4660	XPuller - impact handle

QUICK Sw EaT



- Flexible 24" steel cables will slide through elbows and are interchangeable with the handle to fit different size copper.
- Durable polypropylene handle will fit 1/2" thru 2" cables.
- Long lasting elastomeric plug
- Eliminates "bread" and outperforms all the rest... expensive CO2 freezing devices and copper plug tools.
- PATENT NUMBER 5,819,804

PaRT#	DESCRIPTION
51500	Kit including: handle & 1- each 1/2", 3/4", 1" cables
51040	Handle ONLY
51012	1/2" cable ONLY
51034	3/4" cable ONLY
51010	1" cable ONLY
51114	1-1/4" cable ONLY
51115	1-1/2" cable ONLY
51120	2" cable ONLY

PLUMBERS TOOLS

L

SEaT gaUgE



- Faucet seat gauge
- Keep in toolbox or mount in workshop
- 24 sizes

PaRT# DESCRIPTION

11320 Faucet seat gauge

STEM gaUgE



- Measure sizes of faucet stems
- Keep in toolbox or workshop

PaRT# DESCRIPTION

11325 Faucet stem gauge

HaNDLE gaUgE, FOR MEaSURING STEM BROaCHES



- 21 piece set

PaRT# DESCRIPTION

11321 Faucet handle gauge

aERaTOR gaUgE



- Measures & tests threads on aerators
- 20 sizes

PaRT# DESCRIPTION

11322 Aerator gauge

wRENCH - CLaSSIC DRaIN



- Fits 3-1/2" plastic locknuts
- Fits 3-3/8" die cast basket strainer locknuts
- Fits brass locknuts on brass shower stall drains
- Stamped shell
- 13" overall length
- Offset handle for close quarter work
- Cushion grip

PaRT# DESCRIPTION

7095 Drain wrench

wRENCH - PO PLUG



- Removes PO plugs and tub drains
- 6" long
- Carded for display

PaRT# DESCRIPTION

4555 P.O. wrench

PLUMBER'S TOOLS

PLUMBERS TOOLS

wRENCH - STRaINER NUT



- Cast strainer nut wrench
- Carded for display

PaRT#	DESCRIPTIOn
4569	Strainer Nut Wrench

wRENCH - CLOSET SEaT NUT



- Fits any length bolt
- Fits 99% of closet seat nuts, Die cast
- 3-1/2" long
- Carded for display

PaRT#	DESCRIPTIOn
4557	Wrench closet

wRENCH - BaSKET STRaINER



- Zinc plated steel
- Handle slides
- Carded for display

PaRT#	DESCRIPTIOn
4949	Strainer wrench

KEY - waTER METER & METER SOCKET HEaD

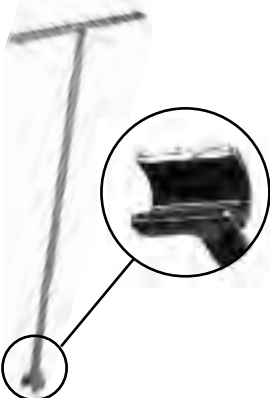

Key water Meter

- Designed for valves that are hard to turn
- Heavy Duty
- Minimum order of 6 keys required

3/8" Slotted Key

- Designed for the City of Toronto valves

Meter Socket Head

- Make any length meter key using 1/2" IPS threaded pipe and this socket

PaRT#	SHaFT	LENgTH	HaNDLE
4061	5/8"	60"	14"
4061SP	5/8"	60"	18"

KEY WATER METER
PaRT# 4061

3/8" SLOTTED KEY
PaRT# 4061SP

RaMBIT FITTING SavER



PATENT NUMBER
4,720,219

SavES TIME

- Repairing solvent welded closet flanges
- Cut 3" and 4" DWV flush, below slab or sub-floor
- Repairing irrigation and swimming pool manifolds, sprinkler risers and freeze damaged plastic pipe

PaRT#	SIZE
3237	1/2"
3239	3/4"
3241	1"
3242	1-1/4"
3243	1-1/2"
3244	2"
3253	3"
3254	4"

PLUMBERS TOOLS, FOR LEAD

L

LEAD LADLES



- Cast iron lead melting ladles

PaRT#	DESCRIPTION
4585	3"
4587	4"

PLUMBERS TYPE LEAD POTS



- Cast iron lead pots

PaRT#	SIZE	vOLUME IN wEIGHT
4592	6"	30 LBS.
4594	8"	70 LBS.

CaULKINGg TOOLS



- For lead & oakum

PaRT#	DESCRIPTION
4442	5/8" x 7" inside caulker
4443	5/8" x 7" outside caulker
4444	5/8" x 7" straight caulker
4446	1-1/2" curved caulker
4447	5/8" x 12" offset yarning iron
4448	5/8" x 16" spring yarning iron

LEAD JOINT RUNNERS



PaRT#	RUNNER SIZE	FOR SOIL PIPE SIZE
4576	# 1	2" to 4"
4577	# 2	4" to 6"
4578	# 3	6" to 10"

LEAD MELTING FURNACE



- Accommodates 6" to 8" lead pots
- Works off direct propane cylinder pressure
- Fits 3" cylinder
- Stand converts furnace to free standing unit
- 1/4" I.P.T. connections

PaRT#	DESCRIPTION
4597	Lead melting furnace without stand
4599	Stand with valve

PLUMBER'S TOOLS

PLUMBERS TOOLS, gaUGES

gaUGe - LaZy HaND waTER TEST



- Dual reading dial (KPA and PSI)
- 2-1/2" dial face
- Regular pressure hand (shown at zero) pushes LAZY hand to peak operating or surge pressure point where it remains until you manually reset it
- Excellent to determine if P/T valve is leaking from failure or if leaking is caused by surge

PaRT#	PSI
1423	0-160#
1428	0-300#

waTER TEST gaUGe



- Dual scale dial (KPA and PSI)
- 2-1/2" dial face

PaRT#	PSI
1430	0-300#

gaUGe - aIR TEST aSSEMBLy



- Plastic face
- All parts precision made and assembled with sealant
- 3/4" FPT
- 2" gauge

PaRT#	PSI	INCREMENTS
1427	0-30#	1/2#
1421	0-100#	2#

TIRE PUMP, HEavY DUTy



- Metal frame
- 160 PSI rated
- 20" tall
- 8" handle
- Large stabilizer base
- 24" hose

PaRT#	DESCRIPTION
1426	Tire pump, heavy duty

DELUXe TIRE PUMP wITH gaUGe



- 24" flexible hose
- With quick connect nozzle
- Foot stabilized
- Chrome cylinder
- Stands 23" tall
- 7" handle
- Complete with gauge

PaRT#	DESCRIPTION
1429	Tire pump with gauge

PLUMBERS TOOLS



waTER SUCTION TOOL



- Suctions out the water remaining in the toilet, drain, p-trap etc.
- 9" hose standard but can be lengthened if required
- Saves time and effort over sponges
- Holds up to 10 oz of water

STRaINER wRENCH 4 IN 1



- Made of super tough LEXAN plastic
- Overall 5-1/2" long
- Fits 3/8" strainer locknut
- Slotted inserts fit sink basket strainer locknuts

PaRT#	DESCRIPTION
4860	Suction gun

PaRT#	DESCRIPTION
4948	Strainer wrench

wRENCHES, SPUD



- Unique attachment for installing and removing closet and urinal spuds
- Slots in tools line up and grip the raised edges
- Includes a 3/4" x 1/2" socket adaptor

SLOaN TaILPIECE TOOL



- Fits into the SLOAN tailpiece
- Fits the raised edges and unscrew the tailpiece
- No damage to the chrome finish

PaRT#	DESCRIPTION
99500	3/4"
99501	1-1/4"
99502	1-1/2"
99503	2"

PaRT#	DESCRIPTION
992180	Tailpiece tool

PLUMBER'S TOOLS

PLUMBERS TOOLS

gRaB aLL TOOL



- Perfect tool for retrieving small objects
- Long bendable shaft
- 3 prong claw opening for easy pickup
- 24" long
- Heavy duty professional grade

PaRT#	DESCRIPTION
4919	Grab all tool

wRENCH FOR FLUSH vaLvES



- For chrome finishes on flush valves
- Fits ZURN, SLOAN, DELANY
- Smooth jaw wrench
- Heavy duty construction
- Replacement for ZURN WONDER WRENCH and RIDGID OFFSET WRENCH

PaRT#	DESCRIPTION
33960	Wrench for flush valves

wRENCH, SOCKET NUT



- Handy tool for plastic faucet nut installation and removal
- Fits 2 and 4 lug nuts
- Overall 5" long

PaRT#	DESCRIPTION
5005	Socket nut wrench

STRaP wRENCH, RUBBER



- Versatile tool with many uses
- Adjustable strap
- Small and large sizes
- Fits up to 4" or 6" max size
- Flexible band adjusts to any shape

PaRT#	DESCRIPTION
5010	Small to 4"
5015	Large to 6"

TEST PLUGS

TEST PLUG - SINGLE SURE TEST



- Maximum Back Pressure
- Air: 10 PSIG
- Water: 30FT. Hd.
- Not sold with inflation hose

PaRT#	IPS SIZE	Max DIaMETER	Max INFLaTION
4730	1-1/4" - 1-1/2"	1-3/4"	30 PSI
4731	2"	2-1/4"	30 PSI
4732	3"	3-1/4"	30 PSI
4733	4"	4-1/4"	30 PSI
4734	6"	6-1/4"	30 PSI
4735	8"	8-1/4"	25 PSI
4736	10"	10-1/4"	25 PSI
4737	12"	12-1/4"	25 PSI

TEST PLUG - LONG SURE TEST



- Maximum Back Pressure
- Air: 10 PSIG
- Water: 30FT. Hd.
- Sold with 2 ft. extension hose

PaRT#	IPS SIZE	Max DIaMETER	Max INFLaTION
4743	2"	2-1/4"	30 PSI
4744	3"	3-1/4"	30 PSI
4745	4"	4-1/4"	30 PSI
4746	4" - 6"	6-1/4"	30 PSI

EXTENSION HOSES



- Tire pump connections
- 1/4" Male x 1/4" Female swivel
- Any length hose can be ordered
- Please call for quote

PaRT#	LENGTH
4759-2	2 ft.
4759-3	3 ft.
4759-4	4 ft.
4759-5	5 ft.
4759-6	6 ft.

TEST PLUG - "SURE TEST" DUAL STAGE LONG



- Maximum back pressure
- Air: 10 PSIG
- Water: 30FT. Hd
- Two-2Ft. hoses are molded as part of the plug
- Additional hose lengths may be required
- This 2-hose plug has twin chamber construction which allows the nose of the plug to be inflated or deflated separately from the back of the plug. This dual stage, 2 hose inflation deflation plug protects the contractor from test water overflow

PaRT#	IPS SIZE	Max DIaMETER	Max INFLaTION
4739	2- 3"	3-1/4"	30 PSI
4740	3- 4"	4-1/4"	30 PSI

TEST PLUGS

TEST PLUG - NYLON EXPANSION



- LYNCAR offers a low pressure nylon test plug available from 2" to 6" sizes
- These are a superior and versatile nylon plug that accommodate a wide variety of applications
- They are shatter proof, corrosion resistant, and can be easily cleaned for long use
- All wing nut plugs when tightened will expand to seal in the pipe
- The plugs are hollow, allowing water or gas to be injected or drained as required

PaRT #	SIZE	PSI
R19027	2"	30
R19028	3"	15
R19029	4"	15
R19030	5"	12
R19031	6"	10

DRaIN CLEaNER BLaDDER

**Part# 4624**

- Unclogs 1" - 2" drains
- Use for swimming pool lines, bathtubs & showers, bathroom sinks
- Works with 1-1/4" sink

Part# 4625

- Unclogs 1-1/2" - 3" drains
- Use for washing machine drains, bathtubs & showers, and kitchen sinks

Part # 4626

- Unclogs 3" - 6" drains
- Use for main drains, basement drains and outside sewer drains

PaRT#	DESCRIPTION
4624	Unclogs 1" - 2" drains
4625	Unclogs 1-1/2" - 3" drains
4626	Unclogs 3" - 6" drains

PLUMBERS TOOLS

TEST CaPS KNOCKOUT



- Solvent weld to ABS or PVC DWV pipe
- Fits both sch. 40 as well as foam core DWV
- Sold in poly bags of 100 pcs

PaRT NUMBER	SIZE
4842	1-1/2"
4843	2"
4844	3"
4845	4"

TEST CaP & CLEaN OUT



- Fits plastic and hubless cast iron DWV pipe
- Made from high quality rubber with a stainless steel clamp
- Rubber has cross rib for extra strength and inside knurling grips pipe

PaRT #	SIZE
4417	1-1/2"
4418	2"
4419	3"
4422	4"
4840	5"
4841	6"

TEST PLUG - CaST IRON



- These test plugs are manufactured from cast iron, with a long test nipple and durable rubber seals

PaRT#	SIZE
4605	6"
4606	8"
4607	10"
4608	12"

TEST PLUG - wING NUT ECONOMY



- Designed with a rubber flange that grips the end of the pipe preventing slippage while tightening
- Red rubber body with plated steel top & bottom and wing nut
- 3" & 4" supplied with "Superfly" wing nut
- Use in plastic, cast iron, DWV. plumbing, pool & spa applications

PaRT#	SIZE
4801	1"
4802	1-1/4"
4803	1-1/2"
4804	2"
4806	3"
4808	4"

SaFE-T-SEaL By g.T. waTER

SaFE-T-SEaL TEST PLUGS FITS 1-1/4 - 2" PIPE



part#4627



part#4628



part#4629



part#4630

- G.T. WATER PRODUCTS has developed its SAFE-T-SEAL line with a concern for the consumer's safety. Test plugs are specifically used to pressure test water lines in new construction and in renovation projects.
- The SAFE-T-SEAL brand, as the name implies, has eliminated all of the negative, dangerous features associated with other major brands. SAFE-T-SEAL's distinctive features include: a safety valve to prevent over inflation or blow-out with built in pressure relief valves which are pre-set to release excess pressure through the plug valve; dual inflation capability gives the user the option of air or water; a waffle-patterned exterior to prevent the plug from slipping while in the pipe; two-stage deflation on long test plugs which eliminates back wash and flooding during deflation

PaRT#	DESCRIPTION
4627	Fits 1-1/4 - 2" pipe
4628	Fits 3" pipe
4629	Fits 3"- 4" pipe
4630	Fits 4"-6" pipe

TEST PLUGS & AUGERS

EXPANDABLE TEST PLUGS G.T. WATER



- Drain king, cleanout plugs
- No metal parts
- Easy to install and remove

PaRT#	SIZE	OEM#
4833	1-1/2"	MTP152
4834	2"	MTP202
4835	3"	MTP302
4836	4"	MTP402
4837	6"	MTP602

TEST PLUG - FLEXIBLE ALL AMERICAN



- The popular "All American" plug is made with two rubber balls and a non rusting aluminum casting
- They can easily be tightened by hand
- Flexible spring and cable
- Rubber balls provide a sure seal, and retains shape after constant use

PaRT#	SIZE
4619aa	1-1/2"
4620aa	2"
4621aa	3"
4622aa	4"
4623aa	6"
4624aa	8"

HAND SPINNER DAHLE



- A reliable stand-by hand spinner when working with tough kitchen and bathroom sink and bath/shower drains.
- Available with either 1/4", 5/16" cable or the very robust 3/8" cable
- Cable won't slip in chuck, yet easy to tighten/loosen
- Large handle is easy to grip
- Available in Bulb Head or Drop Head versions
- Available in either 10 ft. or 20 ft. length cables

PaRT#	DESCRIPTION
982D3810	1/4" x 10'
982D3820	1/4" x 20'
982D40	5/16" x 20' with bulb auger
982D4038	3/8" x 20' with bulb auger
982D4038DH	3/8" x 20' with drop head
982D40DH	5/16" x 20' with drop head

aUgERS

HEavy DUTy TOILET aUgER



- Professional quality tools available in a 3 ft. (K3) or 6 ft. length (K6)
- Ideal for quick and safe removal of obstructions in the toilet
- Specially designed to traverse tough traps
- Available with drop head or bulb head design
- Durable, 1/2" inner-core cable
- Large handles are easy to use
- Vinyl guard protects damage to toilets
- D-6 model expandable 3 ft. longer than D-3

PaRT#	DESCRIPTION
981K3	3' toilet auger with bulb head
981K3DH	3' toilet auger with drop head
981K3RB	3' bulb replacement cable
981K3RD	3' drop head replacement cable
981K6	6' toilet auger with bulb head
981K6DH	6' toilet auger with drop head
981K6RB	6' bulb head replacement cable

URINaL aUgER



- Professional quality tools available in a 3 ft. (K3) or 6 ft. length (K6)
- Ideal for quick and safe removal of obstructions in the toilet
- Specially designed to traverse tough traps
- Available with Drop Head or Bulb Head design
- Durable, 1/2" inner-core cable
- Large handles are easy to use
- Vinyl guard protects damage to toilets
- D-6 model expandable 3 ft. longer than D-3

PaRT#	DESCRIPTION
981D2	29" with bulb head
981D4C	4' inner core cable with bulb head

STaNDaRD TOILET aUgER



- Professional quality tools available in a 3 ft. (K3) or 6 ft. length (K6)
- Ideal for quick and safe removal of obstructions in the toilet
- Specially designed to traverse tough traps
- Available with Drop Head or Bulb Head design
- Durable, 1/2" inner-core cable
- Large handles are easy to use
- Vinyl guard protects damage to toilets
- D-6 model expandable 3 ft. longer than D-3

PaRT#	DESCRIPTION
981D1	3' x 3/8" cable with bulb head
981D4H	3' x 1/2" cable with bulb head

aUgERS

aUgER - CaNISTER TyPE



- 3/8"
- Spin thru augers
- Quality economy model
- 15 & 25 foot lengths

PaRT#	DESCRIPTION
15100	15 ft
15105	25ft

aUgER - CaNISTER DRILL DRIVeN



- 3/8"
- Spin thru augers with drill attachment
- Quality economy model
- 15 & 25 foot lengths

PaRT#	DESCRIPTION
15115	15 ft
15120	25ft

aUgER - CLOSET



- Steel tube closet auger
- Quality economy model
- 3 foot length

PaRT#	DESCRIPTION
15110	3 ft

aUgER - ZIP PLaSTIC MINI SNaKE



- Quickly unclogs sinks, showers and bath drains
- Retail packaged
- No mess!
- No chemicals!
- Strong resin

PaRT#	DESCRIPTION
15125	Mini snake

PLUNgERS

FORCE CUP PLUNgER



- High quality red rubber
- Available in 5" & 6" diameters
- 19" Wood Handle

PLUNgER HEAvy DUTY BOWL FORCE CUP



- Extra large for best pressure with positive seal
- Designed for all types of toilets
- High quality black rubber
- Big bell for big jobs
- 19" Wood Handle

PaRT#	CUP SIZE
4640	5" cup
4641	6" cup

PaRT#	DESCRIPTION
4637	Plunger heavy duty, force cup

SINK PLUNgER, KITCHEN



- 4" diameter cup
- 9" wood handle

PLUNgER - DUaL BLaST FORCE CUP



- High quality rubber
- 19" wood handle
- Bell shape provides positive seal
- Dual action works well on sinks and wash basins, etc

PaRT#	DESCRIPTION
4639	High quality red rubber, for kitchen

PaRT#	DESCRIPTION
4638	Dual blast

PLUNgER - FUNNELED NOSE



- Sold in 12pcs. display pack only
- Funneled nose
- 162 cubic inch displacement
- More plunge per push
- Won't skid
- Fit all toilet bowls

PLUNgER - MaSTER PLUMBER'S FORCE CUP



- Heavy duty
- Ribbed cup for strength
- Provides big blast for all stoppages
- High quality rubber
- 19" wood handle

PaRT#	DESCRIPTION
4642	Dark blue

PaRT#	DESCRIPTION
4636	Professional plunger

PLUMBERS TOOLS

L

NO-HUB TORQUE wRENCH



- Measures torque when turned in a clockwise direction & ratchets when turned counterclockwise
- When the brand screw is tightened to the correct torque, the wrench ratchets so the handle will continue to turn but the drive socket will not
- Retractable reversing lever
- Chrome vanadium socket for 5/16" Hex head screw
- 6" Long
- Torques to 60 inch lbs.

PaRT#	DESCRIPTION
7020	Chrome plated brass

aNTIFREEZE TESTER



- LYNCAR's antifreeze tester (refractometers) is high quality, impact resistant and comes in its own carrying case
- Provides accurate direct reading in both fahrenheit and centigrade of glycol coolants

PaRT#	DESCRIPTION
996055	Chrome plated brass

wRENCH - STRaP



- Will not mar chrome, fittings and nipples
- Nylon strap

PaRT#	DESCRIPTION
4542	7"
4543	11"

CaNE ROD PLUNgER



Builds up pressure of water which forces obstruction clear.

- Used to build up water pressure in pipes & flush through any blockages that may have occurred
- Main uses: unblocking main stacks, floor drains, vents & outside downspout drain stock
- The traditional rods use the best quality imported cane that is carefully selected for uniformity & consistency
- It is assembled with high quality solid brass joints that are securely fitted to the rods with brass rivets

PaRT#	DESCRIPTION
99440	36" long cane rods (3 pack)
99441	Rubber plunger head assembly
99441D	Rubber plunger disc replacement rubber only

PLUMBERS TOOLS



NOTES

PLUMBER'S TOOLS

MAXPOWER PIPE WRENCHES & TOOLS

ALUMINUM PIPE WRENCHES

MAXPOWER



Combining Durability & Light Weight

MAXPOWER aluminum pipe wrenches weigh up to 40% less than cast iron, yet stand up to heavy-duty industrial piping jobs.

- One piece housing with I-beam handle offers comfort and ease of use spring combine for easy ratchet action
- Uses the same induction and flame hardened heel and hook jaws as our cast iron handle pipe wrenches known brands
- Manufactured to meet government specification GGGW-651-E, Type II, Class C

PART#	SIZE	RIDGID	SUPER EGO
MP1210	10"	31090	1041000
MP1214	14"	31095	1041400
MP1218	18"	31100	1041800
MP1224	24"	31105	1042400
MP1236	36"	31110	1043600
MP1248	48"	31115	1044800

STRAIGHT PIPE WRENCHES STEEL

MAXPOWER



- Cast iron handle
- Outstanding quality AND great value
- Handles the toughest piping jobs
- One piece housing with I-beam handle offers comfort and ease of use
- The forged jaw hook, coil and flat spring combine for easy ratchet action
- Heel and hook jaws are induction and flame hardened, then ground to a smooth surface
- Interchangeable with most well known brands
- Manufactured to meet government specification GGG-W-651-E and ANSI B-107

PART#	SIZE	RIDGID	SUPER EGO
MP1008	8"	31005	1020800
MP1010	10"	31010	1021000
MP1012	12"	31015	1021200
MP1014	14"	31020	1021400
MP1018	18"	31025	1021800
MP1024	24"	31030	1022400
MP1036	36"	31035	1023600
MP1048	48"	31040	1024800

TRADESMEN TOOLS

END PIPE WRENCHES, STEEL



- MAXPOWER pipe wrenches will handle the toughest piping jobs

PART#	SIZE	RIDGID	SUPER EGO
MP1110	10"	31060	1121000
MP1114	14"	31070	1121400
MP1118	18"	31075	NA

OFFSET ALUMINUM PIPE WRENCHES



- Combines durability & light weight
- MAXPOWER's 90° offset pipe wrenches are extremely popular because they are over 40% lighter than similar cast iron models
- Where other models have no clearance, this design allows work on pipes close to the wall
- Jaws are parallel to handle allowing tool to fit in tight areas

PART#	SIZE	RIDGID	SUPER EGO
MP1314	14"	31120	1051400
MP1318	18"	31125	1051800
MP1324	24"	31130	NA

PIPE OR PLUMBERS PLIER



- Box joint pliers
- Black phosphate finished
- PVC dipped handle

Compares to
- ROTHENBERGER # 70522
- SUPER EGO # 5221000

PART#	SIZE
6008	10"
6009	12"

BOLT CUTTERS



PART#	REPLACEMENT HEAD ASSEMBLY	SIZE
99BC0708	99BC0708B	8"
99BC0712	99BC0712B	12"
99BC0714	99BC0714B	15"
99BC0718	99BC0718B	18"
99BC0724	99BC0724B	24"
99BC0730	99BC0730B	30"
99BC0736	99BC0736B	36"
99BC0742	99BC0742B	42"

TRADESMEN TOOLS

CURVED JAWS PLIERS



- Curved jaws with wire cutters nickel plated
- Premium quality

PART#	SIZE
4580	5"
4581	7"
4582	10"

LONG NOSE JAWS PLIERS

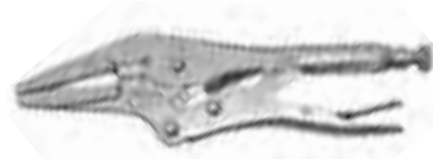

- Long nose plier, with wire cutter
- Nickel plated
- Premium quality

PART#	SIZE
4583	7"
4584	9"

ADJUSTABLE WRENCH



- MAXPOWER manufactures more adjustable wrenches than anyone in the world
- As the world's leading manufacturer, they deliver top quality, value and innovation
- The MAXPOWER factory has been ISO-9001 certified since 1996
- Adjustable wrenches exceed ANSI-ASME B107/ 8M-1991 Standards, metallurgy standards and government torque tests
- Chrome Vanadium & Black Phosphate, Red dipped handle
- Easy to read scale, in inches, just below jaws
- Available in chrome plated, black phosphate or coated dipped (red) handle

PART#	LENGTH	FINISH
MP204	4"	Chrome plated
MP206	6"	Chrome plated
MP208	8"	Chrome plated
MP210	10"	Chrome plated
MP212	12"	Chrome plated
MP215	15"	Chrome plated
MP218	18"	Chrome plated
MP224	24"	Chrome plated
MP104	4"	Black phosphate
MP106	6"	Black phosphate
MP108	8"	Black phosphate
MP110	10"	Black phosphate
MP112	12"	Black phosphate
MP115	15"	Black phosphate
MP118	18"	Black phosphate
MP6004	4"	Red coated handle
MP6006	6"	Red coated handle
MP6008	8"	Red coated handle
MP60010	10"	Red coated handle
MP60012	12"	Red coated handle
MP60015	15"	Red coated handle

PIPE WRENCH REPLACEMENT PARTS

HEEL JAW & PIN ASSEMBLY

Interchangeable with: RIDGID, SUPER EGO, BERKLEY, ROTHENBERGER, STANLEY



PART#	SIZE	REPLACES RIDGID	REPLACES SUPER EGO
MP1508	8"	31585	1020815
MP1510	10"	31610	1021015
MP1512	12"	31635	1021215
MP1512	14"	31635	1021415
MP1518	18"	31675	1021815
MP1524	24"	31700	1022415
MP1536	36"	31725	1023615
MP1548	48"	31750	1044815

HOOK JAW

Interchangeable with: RIDGID, SUPER EGO, BERKLEY, ROTHENBERGER, STANLEY



PART#	SIZE	REPLACES RIDGID	REPLACES SUPER EGO
MP1408	8"	31580	1020802
MP1410	10"	31605	1021002
MP1412	12"	31630	1021202
MP1414	14"	31655	1021402
MP1418	18"	31670	1021802
MP1424	24"	31695	1022402
MP1436	36"	31720	1023602
MP1448	48"	31745	1044802

COIL & FLAT SPRING

Interchangeable with: RIDGID, SUPER EGO, BERKLEY, ROTHENBERGER, STANLEY



PART#	SIZE	REPLACE RIDGID	REPLACES SUPER EGO
MP1708	8"	31590	1020813
MP1710	10"	31620	1021013
MP1712	12"	31640	1021213
MP1714	14"	31660	1021413
MP1718	18"	31680	1021813
MP1724	24"	31705	1022413
MP1736	36"	31730	1023613
MP1748	48"	31755	1044813

WRENCH NUT

Interchangeable with: RIDGID, SUPER EGO, BERKLEY, ROTHENBERGER, STANLEY



PART#	SIZE	REPLACES RIDGID	REPLACES SUPER EGO
MP1608	8"	31595	1020804
MP1610	10"	31615	1021004
MP1612	12"	31645	1021204
MP1614	14"	31665	1021404
MP1618	18"	31685	1021804
MP1624	24"	31710	1022404
MP1636	36"	31760	1023604
MP1648	48"	31765	1044804

TRADESMEN TOOLS

PLUMBER'S EXTRACTOR KIT



- Extract broken bolts quickly
- Carded for display
- 5pcs 1/8", 1/4", 3/8", 1/2", 3/4"

PART#	DESCRIPTION
52501	Plumber's 5 piece Extractor kit

WRENCH - INTERNAL NIPPLE



- CAM type
- Removes or inserts
- Heat treated
- Cadmium plated

PART#	DESCRIPTION
4530	3/8"
4531	1/2"
4532	3/4"
4533	1"

INTERNAL NIPPLE WRENCH DELUXE

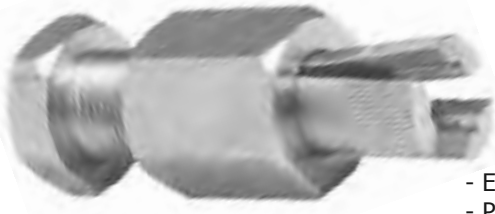

- Excellent for chrome work
- Precision machined and hardened
- Loosens and tightens
- Designed to grip internally the smallest area of a nipple
- Removes broken nipple threads from fittings

PART#	DESCRIPTION
4511	1/2" IPS
4512	3/4" IPS
4513	1" IPS

NIPPLE & SCREW EXTRACTORS



- Removes nipples, bolts and screws
- Left hand spiral tapered flute removes broken piece without thread damage

PART#	IND ID#	TRADE SIZE	DRILL SIZE	BOLT SCREW SIZE
4827	4	1/8"	1/4"	45/64"
4828	5	1/4"	19/64"	59/64"
4829	6	3/8"	13/32"	1-5/32"
4830	7	1/2"	17/32"	1-1/2"
4831	8	3/4"	13/16"	1-47/64"
4832	9	1"	1-1/16"	2-7/32"

TRADESMEN TOOLS

RACK STRAP



- Solid steel construction.
- Zinc plated and yellow chromate finished for weather and salt protection
- Polyester strap is 7 feet long and 1-1/2" wide, UV protected and water resistant

PART#	DESCRIPTION
99RS	Right angle mounting bracket for square tube racks fits racks built by ADRIAN STEEL, CROSS, TREADS, LEER, TRUCK RACK COMPANY, VANGUARD, WEATHERGUARD, and many others.
99RS4	Curved mounting bracket for 1-5/8" O.D. round pipe fits racks built by BLACKMAX, VANGUARD and other custom racks.
99SK	Replacement arm

TIE DOWN STRAPS



- Warning label attached
- Superior quality rubber tie down straps
- Natural rubber & EDPM rubber blend
- Extra material around hooks
- Tensile strength 130kg/285 lbs

PART#	LENGTH	LENGTH STRETCHED
4901	9"	14"
4903	15"	20"
4905	20"	25"
4907	31"	36"
4909	41"	46"

TRADESMEN TOOLS

FLAME-GUARD



- Protects wood, painted or metal surfaces from the heat and flame of a torch!
- Designed for soldering and brazing using propane and MAPP gas

PART#	SIZE
59500	9" x 12"
59501	24" x 24"

FLAME BLANKET EXTRA HEAT



- Flame-blanket protects wood, painted or metal surfaces from the heat and flame of a torch!
- Designed for soldering and brazing using propane and MAPP gas
- You can't buy a more durable or longer lasting flexible heat & flame protective product
- No toxic smoke

PART#	DESCRIPTION
59502	12" x 12"
59503	9" x 12"

LIGHTER SPARK



- Round, single, or triple flint
- Large hood traps more gas
- File has keen cutting surface
- File rotates providing a fresh surface for the flint
- Flints good for 1,500 ignitions

PART#	DESCRIPTION	PACKAGE
4430	Lighter complete	12
4432	Extra flints	5

LIGHTER - SHURLITE SPARK



- Round, single, or triple flint
- Large hood traps more gas
- File has keen cutting surface
- File rotates providing a fresh surface for the flint
- Flints good for 1,500 ignitions

PART#	DESCRIPTION	PACKAGE
4437	Lighter complete	12
4438	Extra Flints	3

TIN SNIPS



- Hand guards
- Cushion grips
- Forged blades
- Edges honed
- Size 10"
- Cut 1-1/2"

PART#	DIRECTION OF CUT
4340	Left
4341	Right
4342	Straight

TRADESMEN TOOLS

WIRING TOOL CHANNELLOCK



- Strips wire with no damage to conductor
- Crimps both insulated and non-insulated wire

PART#	DESCRIPTION
C908	8-1/4" long

PLIER - DIAGONAL CUTTER CHANNELLOCK



- Lap joint plier
- Polished high carbon drop forged steel
- Perfectly mated cutter, heat treated to hold it's edge

PART#	DESCRIPTION
C337	Diagonal cutting

PLIER - LINEMANS



- Polished high carbon drop forged steel
- Perfectly mated cutter, heat treated to hold it's edge

PART#	DESCRIPTION
C317	7-1/2" long

PLIER - PLUMBERS HELPER CHANNELLOCK



- Heavy duty construction
- Perfectly mated cutters, scientifically heat treated to hold its edge
- Round nose design
- Enclosed-joint design holds cutters in perfect alignment for the life of the plier

PART#	DESCRIPTION
C349	Plier Linemans 9" plier

PLIER - GRIPLOCK CHANNELLOCK



- Ergonomically designed offset head for greater leverage
- Patented PermaLock® fastener eliminates nut and bolt failure
- CHANNELLOCK BLUE comfort grips.

PART#	LENGTH	ADJ	CAP
CGL6	6"	5	1-1/4"
CGL10	10"	5	1-3/4"
CGL12	12"	6	2-7/8"

TRADESMEN TOOLS

PLIER TONGUE & GROOVE CHANNELLOCK



- Right angle teeth grip in all directions for maximum bite and minimum wear.
- Patented undercut tongue and groove design assures no slip jaw action.
- Patented reinforcing edge minimizes stress breakage.
- Patented PermaLock® fastener eliminates nut and bolt failures.
- Distinctive CHANNELLOCK BLUE comfort grips

PART#	LENGTH	ADJ	CAP
C420	9-1/2"	5"	1-1/2"
C426	6-1/2"	5"	7/8"
C430	10"	7"	2"
C440	12"	7"	2-1/4"
C460	16"	8"	4-1/4"
C480	20-1/4"	12"	5-1/2"

PLIER - CURVED JAW CHANNELLOCK



- Curved jaw for use on round stock and tubing
- Right angle teeth grip in all directions for maximum bite and minimum wear.
- Patented undercut tongue and groove design assures no slip jaw action.
- Patented reinforcing edge minimizes stress breakage.
- Patented PermaLock® fastener eliminates nut and bolt failures.
- Distinctive CHANNELLOCK BLUE comfort grips

PART #	LENGTH	ADJ	CAP
C422	9-1/2"	5"	1-1/2"
C442	12"	7"	2-1/4"

PLIER - WIRE HOSE CLAMP CHANNELLOCK



- Heavy-duty design for industrial use
- Cross hatching on jaws grabs work tightly
- Precision made of fine polished, high carbon drop forged steel.
- Patented PermaLock® fastener eliminates nut and bolt failures.
- CHANNELLOCK BLUE® comfort grips.

PART#	LENGTH
C558	8"

TRADESMEN TOOLS

PLIER - LINEMANS SIDE CUTTERS



- Vinyl grip handles
- Polished head
- Honed by hand
- Standard duty

PART#	LENGTH
4101	7" plier linemans

WIRE STRIPPER



- Adjusting stop on the gripping handles permits adjustment for wire size
- Vinyl grip handles

PART#	DESCRIPTION
4107	Wire stripper

ANGLE NOSE SLIP JOINT PLIER WITCO



- Easily fit 1-1/2" slip joint nuts
- Forged and chromed
- Vinyl grip handles

PART#	LENGTH
4062	6-3/4"
4065	8"
4063	10"

SMOOTH JAW ANGLE NOSE SLIP JOINT PLIER WITCO



- Smooth jaw plier for gripping plated fittings
- Satin chrome finish
- Vinyl grip handles

PART#	DESCRIPTION
4064	10"

TRADESMEN TOOLS

UTILITY SCISSORS



- Versatile, rugged, and multipurpose, these Utility Scissors feature stainless steel offset blades and molded plastic handles for a firm comfortable grip
- Your hands are always positioned above the materials for safer cutting.
- These scissors are powerful enough to cut most metals, yet great for tapes, wire, plastics
- Their handy 7" size make them a great addition to the contractors tool box

PART#	DESCRIPTION
4572	Utility scissors 7"

KNIFE - DISPOSABLE UTILITY



- 8 part breakaway blade
- Disposable
- Plastic case
- Metal blade
- 6" long

PART#	DESCRIPTION
4322	Knife - disposable

KNIFE - UTILITY



- Utility knife is retractable
- Blades are heavy duty, universal size and are reversible for extra life
- Carded for display



PART#	DESCRIPTION
4323	Utility knife with blades
4325	5 pack of replacement blades

KNIFE - UTILITY HEAVY DUTY



- Auto loading utility knife
- Zinc die casting body with rubber grip with 8pc blade
- Carded for display



PART#	DESCRIPTION
4326	Utility knife - heavy duty with blades
4325	5 pack of replacement blades

NUT SETTER



- Use with 1/4" drill to drive hex sheet metal and anchor screws
- Magnetic socket and heat treated
- 1/4" drill shank
- 1-3/4" length

PART#	DESCRIPTION
1594	1/4"
1595	5/16"

TRADESMEN TOOLS

NUT DRIVERS



- LYNCAR nut drivers
- High quality contractor grade
- Card packaged each
- Item 4124 is a box set of 7 pieces

PART# DESCRIPTION

4125	3/16"
4127	1/4"
4129	5/16"
4130	11/32"
4131	3/8"
4132	7/16"
4133	1/2"

BEAM CLAMP WRENCH



- A specialty made ratchet wrench for easy installation of beam clamps

PART# DESCRIPTION

9955	Beam clamp wrench
------	-------------------

WRENCH - RATCHETING BOX



- OFFSET
- Opening 12 pt.

PART# TYPE SIZE LENGTH

4497	Offset	3/8" x 7/16"	8"
4491	Straight	3/8" x 7/16"	5-1/2"
4492	Straight	1/2" x 9/16"	6-3/4"
4494	Straight	5/8" x 3/4"	6-3/4"
4495	Straight	3/4" x 7/8"	6-3/4"
4496	Straight	1/2" x 7/16"	6-3/4"

MULTI BIT SCREWDRIVER 19 IN 1 RATCH STYLE

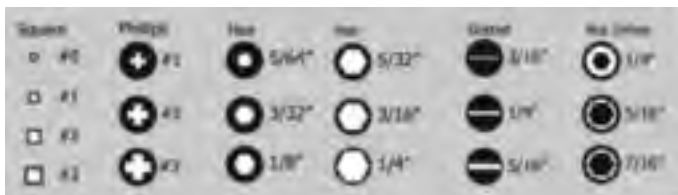

- Blister packaged
- Great counter seller
- Robertson bits, nut drivers

PART# DESCRIPTION

4200	19 in 1 screwdriver
------	---------------------

TRADESMEN TOOLS

MINI TUBING CUTTER



- Good quality DIY mini cutter
- Cuts 1/8" to 7/8"
- Compare to RIDGID #103

PART#	DESCRIPTION
4351	Mini cutter
4349	Cutter wheel

WIDE MOUTH MINI TUBING CUTTER



- For cutting copper, brass, aluminum, thin-walled steel tubing as well as PVC, synthetic resin and plastic sleeved tubing
- Convenient shape with very small working radius (42 mm) facilitating work in confined spaces and on parallel tubing.
- Large knurled wheel for effortless pressure adjustment.
- Twin grooved rollers for cutting close to flared ends.
- Good quality professional mini cutter
- Cuts 1/8 to 1 1/8"
- Compare to SUPER EGO 728 and RIDGID #101

PART#	DESCRIPTION
4353	Wide mouth cutter
4349	Cutter wheel

STANDARD TUBING CUTTER



- Sturdy body for DIY or service use
- Grooved roller
- Cuts 1/8" to 1-1/8" tubing
- Retractable Deburring tool attached
- Compare to SUPER EGO 725 or RIDGID #10

PART#	DESCRIPTION
4350	Standard tubing cutter
4349	Cutter wheel

LYNCAR ZIP ACTION TUBE CUTTER



- Professional duty zip-action tube cutter!
- Four Roller top support
- Cuts 1/4" to 2 1/2"
- One wheel for copper & one wheel for plastic
- Deburring tool attached
- Compare to SUPER EGO 750, RIDGID 152, ROTHENBERGER R70030
- Fast ratchet smooth action telescopic tube cutter for cutting copper, plastic, brass, aluminum and thin walled steel tubing.

PART#	DESCRIPTION
4354	Cutter
4352WP	Cutter wheel for plastic
4352W	Cutter wheel for copper

TRADESMEN TOOLS

TUBING CUTTER, BEARING TYPE, TELESCOPIC



- Bearing action for ease of use
- Professional duty telescopic tube cutter!
- Four roller top support
- Cuts 1/8" to 1-5/8"
- Deburring tool stored in frame
- Carded packaging
- Professional quality

PART#	DESCRIPTION
4359	Tubing cutter, bearing type, telescopic
4352WP	Wheel for plastic
4352W	Wheel for copper

LYNCAR TUBE CUTTER HD38



- Professional duty telescopic tube cutter!
- Four roller top support
- Cuts 1/8" to 1-5/8"
- Deburring tool stored in frame
- Compare to SUPER EGO 735, RIDGID 150L, ROTHENBERGER R70027
- Carded packaging

PART#	DESCRIPTION
4352	Cutter
4352WP	Wheel for Plastic
4352W	Wheel for Copper

TUBE CUTTERS LENOX



- Four roller tracking system keeps tube from threading
- Will not damage cutting wheels
- Full-stop feed system prevents wheels and rollers from coming into contact
- Professional deburring
- Cleanly and easily deburr pipes with the replaceable machinist's reamer

PART#	TYPE	DESCRIPTION
L21010	Tubing cutter	1/8" - 1-1/8"
L21011	Tubing cutter	1/8" - 1-3/8"
L21012	Tubing cutter	1/8" - 1-3/4"
L21013	Tubing cutter	1/4" - 2-5/8"
L21015	Replacement cutter wheel	For aluminum, brass, copper, thin wall steel
L21016	Replacement cutter wheel	For plastic/PVC
L21017	Replacement cutter wheel	For copper and aluminum

HANDY TUBING CUTTER



- For copper & plastic
- Clip on & rotate

PART#	DESCRIPTION
4362	Cuts 1/2"
4362W	Extra wheels for part#4362 (3 pack)
4363	Cuts 3/4"
4363W	Extra wheels for part#4363 (3 pack)

TRADESMEN TOOLS

PIPE CUTTERS - METAL FOR BERKLEY & RIDGID



- Malleable iron frames for durability
- Wide rollers help ensure blade tracking
- Rollers can be removed and replaced with blades to speed cutting
- Replaceable cutter wheels which can be selected to suit the application
- BT-30033 is designed to fit the BERKLEY BT-5020/MP50301 power drive as well as the RIDGID™ model No. 300 and 55
- BT-50000 is a hand cutter designed to cut pipe up to 2" diameter

PART#	RIDGID X-REF	DESCRIPTION
BT30033	42370	Power drive cutter
BT60000	34775	Roller wheel 1-2" cap.
BT60002	34780	Cutter wheel pin
BT60003	34785	Roller wheel 2-1/2" - 6"
BT60004	34790	Cutter wheel pin

HEAVY DUTY STEEL PIPE CUTTER MAXPOWER

MAXPOWER



PART#	TYPE	DESCRIPTION
MP42A	Cutter	2A style cuts up to 2" pipe
MP4000	Cutter	4A style cuts up to 4" pipe
MP4003	Replacement cutter wheels	For 2A heavy duty cutter
MP4004	Replacement cutter wheels	For 4A heavy duty cutter

ROLL GROOVER, MAXPOWER



- Cast iron body roll groover
- Net weight: 17kg
- Grooves 1-1/4" - 6" schedule 10, and 1-1/4"-3" schedule 40
- Mounts on most standard threaders, including RIDGID and MAXPOWER

PART#	DESCRIPTION
MP91600G	Groover

POWER THREADER MAXPOWER



- Compact design for easy transportation
- Versatile design
- Motor: 1500W universal type, 110V, Speed: 38 RPM
- Cast aluminum body
- Capacity: 1/2" - 2"
- Automatic die head and oiler with gun
- Two sets of dies and 4 litres of oil included
- T type transporter is optional

PART#	DESCRIPTION
MP50301	Power threader

TRADESMEN TOOLS

PIPE CUTTER WHEEL BERKLEY



- BERKLEY pipe and tubing cutter wheels are made in the USA using the highest quality tool steel
- Wheels are then heat treated to exacting standards to ensure durability

PART#	RIDGID X-REF	DESCRIPTION
BT01000	33105	Heavy duty pipe cutter wheel 2"
BT01100	33100	Thin pipe cutter wheel 2"
BT01200	33110	Stainless steel pipe cutter wheel 2"
BT02000	44185	Pipe cutter wheel 2"
BT02100	44190	Pipe cutter wheel 2"stainless steel
BT04000	33125	Heavy duty pipe cutter wheel 4"
BT06000	33145	Pipe cutter wheel 6"
BT01500	33160	Thin tubing cutter wheel for models 10,15,20
BT01210	33165	Heavy duty tubing cutter wheel for models 10,15,20
BT02110	33175	Heavy duty tubing cutter wheel for models 30,40,136,136P
BT03400	33185	Thin tubing cutter wheel for models 103,104,105,131,132,205
BT04400	03504	Cutter wheel for std. steel pipe 2" - 4"
BT06600	03506	Cutter wheel for std. steel pipe 6"
BT06700	03524	Cutter wheel for cast iron pipe 6" - 12"
BT08000	03508	Cutter wheel for std. steel pipe 8" - 12"

THREADED ROD CUTTER



- Designed for cutting mild steel threaded rod
- Deburring work after cut can be ELIMINATED because of unique blades and mechanism
- FASTER, CLEANER and SAFER!
- The answer to the occupational safety ban on using chop saws for deburring threaded rod!
- Approximately 600 cuts per side of double sided blades

PART#	DESCRIPTION
MP991090	Standard rod cutter with 3/8" dies
MP991092	Replacement 3/8" Dies

TRADESMEN TOOLS

PACE 1039 MINI-MITE™ SERVICE GROOVER



- Goes from in-place grooving to machine grooving in one motion without the need of spending valuable time looking for tools
- Self-contained
- Can be entirely operated with its own multi-function crank
- Portable & rugged construction with a larger top roller bearing, heavier top slide, and more material in the housing to make for more durability
- All hex drives on the PACE 1039 Mini-Mite™ are 15/16" so one wrench fits everything!
- Chucks in a RIDGID 300, BERKLEY BT3000/BT5020/MAXPOWER 50301

PART#	DESCRIPTION
991039	1¼" – 6" schedule 40 capacity

HYDROSTATIC TEST PUMPS



- LYNCAR offers general pump equipment line of electrical hydrostatic test pumps
- The leader in this field since 1969
- Housed in a protective metal case and can be used with water or gravity feed
- Shipped with an adjustable relief valve
- Tests fire hose and fire sprinkler systems

PART#	DESCRIPTION
996334250	250 PSI, 1/2 HP, 3 GPM - 60 LBS
996334350	350 PSI, 3/4 HP, 3 GPM - 64 LBS
996334550	550 PSI, 3/4 HP, 2 GPM - 65 LBS
996334750	750 PSI, 1 HP, 2 GPM - 70 LBS
9963341000	1000 PSI, 1.5 HP, 2 GPM - 92 LBS

HAND OPERATED TEST PUMP MAXPOWER

MAXPOWER



- Ideal for pressure testing residential water tanks and solar systems to 200 PSI
- Comes with shut-off valve gauge and connector hose

PART#	DESCRIPTION
MP8125	Hand operated test pump

SWEDGING TOOL

- For copper tubular
- Swedge copper
- From 3/8" to 3/4" sizes



PART#	DESCRIPTION
4330	3/8" to 3/4"

COPPER SIZING TOOLS



- Impact type to re-round copper tubing
- For "M" copper tubing

PART#	DESCRIPTION
4343	1/2"
4344	3/4"
4345	1"

TRADESMEN TOOLS

TUBE SPRING BENDERS



- For copper, aluminum & soft thin wall tubing
- Length - 10"

PART# DESCRIPTION

5160	1/4"
5162	3/8"
5164	1/2"
5165	5/8"

WRENCH - ADJUSTABLE CHANNELLOCK



- Measurement scales (in. on front mm on reverse) are handy for sizing nuts, pipe and tube diameters
- Easier use in more confined spaces
- Ergonomic handle is wider for more comfortable grip
- Chrome vanadium steel construction with (2NI-1Cr) coating
- Exceeds ASME B 107.8 M, B.S. 6333 and DIN 31117 standard

PART# DESCRIPTION

C804	4"
C806	6"
C808	8"
C810	10"
C812	12"

COPPER TUBE FLARE PUNCHES



- Soft copper tubing
- Rerounds & flares copper pipe

PART# DESCRIPTION

4367	3/4"
4368	1"

COPPER DEBURRING TOOL



- Die cast
- Debur up to 1-1/4" copper or CPVC

PART# DESCRIPTION

4356	Metal body
-------------	------------

TRADESMEN TOOLS

FLARING TOOL - DELUXE



- Deluxe flaring tool with swing release
- Comfort grip handles
- Adjustable gripping pressure
- 3/16" to 5/8" tubing
- Accommodates wide range of tubing

PART#	DESCRIPTION
-------	-------------

4361	Flaring tool - deluxe
------	-----------------------

FLARING TOOL - ECONOMY



- For O.D. sizes: 3/16", 1/4", 5/16", 3/8", 1/2", 5/8"
- Makes smooth flare
- Packed in pouch

PART#	DESCRIPTION
-------	-------------

4360	Flaring tool - economy
------	------------------------

DEBURRER HSS



- For quick deburring of edges, tubular and sheet materials
- Replaceable blade and plastic handle

PART#	DESCRIPTION
-------	-------------

21655	Deburrer HSS
-------	--------------

21652	Replacement blade
-------	-------------------

EASY BEND KIT FOR SOFT COPPER



- Easily puts a 90° bend on 3/4" tube in less than 10 seconds!
- One hand manual ratchet operation
- Soft copper
- Thin wall hydraulic tubing
- Coated soft copper pipe
- Plastic coated aluminum composite pipe
- **Kit Includes:** 1 ratchet handle, 2 crossbars, 5 bending formers, 1 o.d. / i.d. reamer, 1 tubing cutter 1/8" to 1-1/8" with 1 spare blade, heavy-duty carrying case
- complete package for o.d. 3/8"- 1/2"- 5/8"- 3/4"- 7/8

PART#	DESCRIPTION
-------	-------------

991555	Easy bend kit
--------	---------------

HEX KEY TOOL CADDY



- Hex key sets
- Carded for display
- High contractor quality
- Popular sizes for plumbers

PART#	# OF KEYS	KEY SIZES
-------	-----------	-----------

3040	9	5/64", 3/32", 7/64", 1/8", 9/64", 5/32", 3/16" 7/32", 1/4"
------	---	--

3041	8	.050", 1/16", 5/64", 3/32", 7/64", 1/8", 9/64", 5/32"
------	---	---

3042	5	3/16", 7/32", 1/4", 5/16", 3/8"
------	---	---------------------------------

3043	8	3/32", 7/64", 1/8", 9/64", 5/32", 3/16", 7/32", 1/4"
------	---	--

TRADESMEN TOOLS

PIPE TAPS

- High carbon steel
- Tapered thread taps



PART#	PIPE SIZE	# OF NPT	TAP DRILL SIZE
4812	1/8"	27	1/8"
4813	1/4"	18	7/16"
4814	3/8"	18	37/64"
4815	1/2"	14	45/64"
4816	3/4"	14	59/64"
4817	1"	11-1/2	1-5/32"
4818	1-1/4"	11-1/2	1-1/2"
4819	1-1/2"	11-1/2	1-47/64"
4820	2"	11-1/2	2-7/32"

DRILL SET - 29 PIECE



- Sizes 1/16" to 1/2" by 64ths
- Polished flutes
- High speed steel industrial quality
- Compact steel case
- Guaranteed quality
- Drill Compartment which serves as handy drill gauges

PART#	DESCRIPTION
4664	Drill set 29 piece

DRILL SET
13 PIECE



- Sizes 1/16" to 1/4" by 64ths
- Polished flutes
- High speed steel for wood, plastic and soft or thin gauge metal
- Plastic case
- Blister carded for peg board

PART#	DESCRIPTION
4663	Drill set 13 piece

CARBIDE HOLE
SAWS

- Cuts ceramic tile & stainless steel
- Complete with d-drive arbor & carbide drill



PART#	DESCRIPTION
3912	1-1/4"
3913	1-3/8"
3915	1-3/4"
3916	Arbor with carbide drill

CARBIDE BI-METAL
BLADES

- 6" or 9" blades x 3/4" width
- Fits most reciprocating saws
- Flexible alloy steel
- Diamond hard tungsten carbide grit

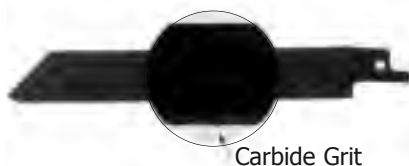

PART#	DESCRIPTION
3835	6" blade
3845	9" blade

TRADESMEN TOOLS

ON CENTRE TOOL



- Accurately locates position of holes to be drilled into pipe
- Excellent for field or shop use
- The housing is aluminum
- The mineral spirit leveling vials are inset, protected by the housing and visible from 2 sides
- They are made from tough acrylic plastic and can be replaced if damaged

PART#	DESCRIPTION
990N	On centre tool

SPOT RIGHT LEVEL



- Both a torpedo level and a gunner nipple in one handy tool
- Also has 1/2", 3/4", and 1" threaded ends for multiple use

PART#	DESCRIPTION
99SR	Spot right level

PLUMB BOBS



- Nickel plated
- True hanging

PART#	DESCRIPTION
4450	3-3/8" x 5oz
4451	3-3/4" x 8oz

TORPEDO LEVEL



- Magnet and grooved
- Coloured liquid in vials
- 9" length
- Magnet for iron pipe
- Black plastic

PART#	DESCRIPTION
4472	Level, plastic 9"

TAPE MEASURE - K74 DURA-COAT



- Power return
- Belt Clip
- Yellow Steel & Tape
- Nylon Coated Blade
- Metric & Imperial Rule

PART#	DESCRIPTION
3948	3/4" x 16'
3949	1" x 25'

MAGNETIC TAPE MEASURE



- Large magnetic end hook
- Nylon coated blade for maximum durability
- Impact absorbing rubber jacket protects case
- Private label opportunity on orders over 500pcs

PART#	DESCRIPTION
3947LC	1" x 25' metric & imperial

TRADESMEN TOOLS

CHALK PLUMB LINE



- Will mark on any surface (wood, brick, stone, & metal)
- Die cast aluminum case
- Durable grey enamel finish
- Slide action lock and hook ring provides true plumb bob action
- Lock releases automatically on rewind
- Opens for easy filling of powdered chalk
- Nylon line on pop - in reel is easily replaced

PART#	DESCRIPTION
5193	Chalk & Plumb Line

CHALK REFILLS



- For self chalking reels
- High visibility
- Long lasting

PART#	DESCRIPTION
5196	Red 12 x 8 oz.
5195	Blue 12 x 8 oz.

FLASHLIGHT RAYOVAC



- Flashlights by RAYOVAC, water resistant construction polypropylene shock proof, and chemical / grease proof.
- Superior light performance.
- All flashlights take size "D" batteries.

PART#	DESCRIPTION
362	Regular 2 cell
363	Long 3 cell
365	Magnet 2 cell

FLASHLIGHT INDUSTRIAL



- Industrial grade flashlights, good quality , tough and built to last.

PART#	DESCRIPTION
367	Regular 2 cell
369	Magnet 2 cell

LANTERNS



- Two types of Lantern flashlights available, standard or on a swivel base
- 6 volt batteries

PART#	DESCRIPTION
325	Swivel
326	Standard

FLASHLIGHT BULBS



- Replacement bulbs for LynCar and other standard flashlights

PART#	DESCRIPTION
383	For 2 "D" cells
384	For 3 "D" cells

TRADESMEN TOOLS

TROUBLE LIGHTS



- LYNCAR'S trouble lights are professional quality with metal bulb guards.
- All models have a 13A electrical rating and 16/3 core rated cords.
- **Part# 8072 & part#8073** have "ARCTIC CORDS" a premium outdoor cord good for up to -58 degrees !
- cUL listed

PART#	LENGTH	CORD TYPE
8072	25 ft	Arctic
8073	50 ft	Arctic
8165	25 ft	Standard
8166	50 ft	Standard

VINYL OUTDOOR EXTENSION CORDS



- Three conductor
- Lighted ends
- Meets OSHA requirements for outdoor use
- Vinyl jacket resists moisture, abrasion and prolonged exposure to sunlight
- 12/3 SJTW, 15A rating
- cUL listed

PART#	DESCRIPTION
8167	50'
8168	100'

E/Z WIND CORD ORGANIZER



- Holds up to 100' of electrical extension cord
- Holds 2 different cords
- Comfort grips

PART#	DESCRIPTION
4862	Cord organizer

TRADESMEN TOOLS

CAULKING GUN - DROP IN HALF BARREL



- Drop in half barrel type caulk gun
- Steel body construction
- Smooth rod with hook end for easy dispensing
- Thumbs release and spring release
- Fits all standard size tubes

CAULKING GUN - SKELETON TYPE



- Skeleton type caulk gun
- Steel construction
- Hex rod
- Built in ladder hook and catch plate

PART#	DESCRIPTION
5100	Drop in half barrel

PART#	DESCRIPTION
5105	Skeleton type

SCREEDING PADS SET



- Fills cracks and removes extra filler
- Fills cracks between the tiles
- 4 pc set for up to 18 shapes
- Carded for display

PART#	DESCRIPTION
5050	Screeding pads

SILICONE SCRAPER



- Silicone scraper with stainless steel blade
- Multi function design
- Works in forward or backward position
- Cleaning blade in handle
- Carded for display

PART#	DESCRIPTION
5045	Silicone scraper

HAND & CUTTING TOOLS

HACKSAW



- Adjusts to 4 lengths, plated frame
- DIY quality

PART#	DESCRIPTION
4254	Adjusts 10" to 12"

SUPER HACKSAW



- Comfort front end grip
- Tension wheel for tighter blade
- Stores extra blades
- Cuts sideways
- Cuts flush to surface
- 4" Depth
- Supplied with 12" blades

PART#	DESCRIPTION
4267	Super hacksaw

HACKSAW LENOX



- Lever tensions the 12" (300mm) hacksaw blade to 30,000 psi (21 kg. mm2), about twice that of ordinary frames
- Mount blade at 45° for flush cutting jobs
- Use frame as jab saw. Set screw holds blade in position
- Use as a compass saw with No.20585-156R reciprocating blade
- Store spare blades inside tubular back

PART#	DESCRIPTION
L4012	Hacksaw

HACKSAW BLADES LENOX



- Electron beam weld
- High speed steel edge
- Tuff tooth
- Flexible spring steel back

PART#	LENGTH	TPI
L018	10"	18
L024	10"	24
L032	10"	32
L214	12"	14
L218	12"	18
L224	12"	24
L232	12"	32

TRADESMEN'S TOOLS

HAND & CUTTING TOOLS

JOURNEYMAN PLASTIC PIPE SAW



- Cuts PVC, ABS, fiber pipe, wood and drywall
- Unbreakable aluminum die cast handle
- Large, comfortable grip
- Flame hardened blade
- Replacement blade changes in seconds
- Ten teeth per inch

PART#	DESCRIPTION	DESCRIPTION
4331	MITY MITE 13" saw	Complete saw w/ metal handle
4333	JOURNEY MAN 18" saw	Complete saw w/ metal handle
4333H	Handle only for PVC saw	Aluminum die cast handle
4333UH	Handle only for PVC saw	Unbreakable plastic handle
4331B	Blade only for PVC saw	13" Blade
4333B	Blade only for PVC saw	18" Blade

PVC/ABS SAW LENOX



- Wide, rigid carbon steel blade with hardened teeth will breeze through any diameter plastic pipe, wood and nail-embedded wood
- Its heavy-duty, lightweight aluminum handle features a comfortable hand grip and a large opening for maximum finger clearance, allowing room for work gloves

PART#	TYPE	SIZE
LHSF120	Complete saw	12"
LHSF180	Complete saw	18"
LHSB12	Blade only	12"
LHSB18	Blade only	18"
L-FCBA	Blade only	Blade adaptor flush cutting

PIPE SHOOTER - PVC INSIDE CUTTER



- Internal PVC cutter
- Fits all electric drills, Pipe Shooter is the fast and easy way to make cuts for closet flange, tub waste overflow and shower drains
- The blade is hardened steel for tough, long lasting cutting of pipes 1 1/2" and larger
- Saves installation time

Cuts Fast! Easy to Use! Cutoff:

- PVC / ABS Closet Flange
- Tub Waste and Overflow
- Shower Drains
- Many Hard to Reach Applications
- Also Cuts Wood for Sink Rim Lugs



PART#	DESCRIPTION
99PS100	4-1/2" - length shaft
99PS110	7-1/2" - length shaft
99PS102	Replacement cutter wheel

TRADESMEN TOOLS

TINY TIM HACKSAW



- Cuts wood, plaster, steel, brass, etc.
- Vinyl grip handle
- 1/4" x 6" x 32T
- Tube of 10 replacement blades (**part# 4292**)

PART#	DESCRIPTION
4290	Hacksaw with blade
4292	10 pack replacement blades

CLOSE QUARTER® SAW LENOX



- Close cutter saw to cut in tight areas

PART#	DESCRIPTION
L908	Hacksaw w/ blade
L906	Blades 10Pk

TRI-FOLD SAW LENOX



- Fits in your pocket
- Three locking positions
- For wood and /or drywall
- Uses standard blades
- Comfortable hand grip

PART#	DESCRIPTION
L3618	For metal
L3636	Wood, drywall
L618636	With both blades

PVC CABLE SAW



- 24" stainless steel cable
- Great for tight spots, need only 1/4" clearance
- Easily stored
- 30" overall

PART#	DESCRIPTION
4336	PVC cable saw

SAW BLADES - BI-METAL RECIPROCATING - LENOX

M

LENOX 414R BLADE



- Heavy gauge metal 1/4"-1/2" / 6-13mm, hard rubber, fiber & angle iron
- TPI = 14T

LENOX 418R BLADE



- Heavy gauge metal 1/8"-1/4" / 3.2-6mm, conduit & tubing, opening wood crates, removing wood siding or shingles
- TPI = 18T

PART#	# PER PACK	SIZE
L414R	5	4 x 3/4 x .035
L414RQ	25 BULK	4 x 3/4 x .035

PART#	# PER PACK	SIZE
L418R	5	4 x 3/4 x .035
L418RQ	25 BULK	4 x 3/4 x .035

LENOX 610R BLADE



- Wood, compositions, plastic, cast aluminum & non-ferrous metals
- TPI=10T

LENOX 614R BLADE



- Heavy gauge metal 1/4"-1/2" / 6-13mm, hard rubber, fiber & angle iron
- TPI=14T

PART#	# PER PACK	SIZE
L610R	5	6 x 3/4 x .035
L610RQ	25 BULK	6 x 3/4 x .035

PART#	# PER PACK	SIZE
L614R	5	6 x 3/4 x .035
L614RG	5 GOLD	6 x 3/4 x .035
L614RQ	25 BULK	6 x 3/4 x .035

LENOX 618R BLADE



- Heavy gauge metal 1/8"-1/4" / 3.2-6mm, conduit & tubing, wood siding or shingles
- TPI=18T

LENOX 624R BLADE



- Finer teeth for faster cutting of metal to 1/8", galvanized pipe
- TPI=24T

PART#	# PER PACK	SIZE
L618R	5	6 x 3/4 x .035
L618RG	5 GOLD	6 x 3/4 x .035
L618RQ	25 BULK	6 x 3/4 x .035

PART#	# PER PACK	SIZE
L624R	5	6 x 3/4 x .035
L624RG	5 GOLD	6 x 3/4 x .035
L624RQ	25 BULK	6 x 3/4 x .035

TRADESMEN'S TOOLS

TRADESMEN TOOLS

LENOX 636RP BLADE



- For plaster, plaster board and lath
- Bi-directional cutting
- TPI= 6T

PART#	# PER PACK	SIZE
L636RP	5	6 x 3/4 x .050"
L636RQ	25 BULK	6 x 3/4 x .050"

LENOX 650R BLADE



- Heavy duty. Extended life when cutting pipe, structural steel, stainless steel: 3/16"-3/4"/ 5-20mm. Fire and rescue
- TPI=10/14T

PART#	# PER PACK	SIZE
L650R	2	6 x 3/4 x .050"

LENOX 656R BLADE



- Rough work in wood, fast cutting, used in remodeling and demolition work
- TPI=6T

PART#	# PER PACK	SIZE
L656R	5	6 x 3/4 x .050"
L656RG	5 GOLD	6 x 3/4 x .050"
L656RQ	25 BULK	6 x 3/4 x .050"

LENOX 676RC BLADE



- Wood contours
- TPI=6T

PART#	# PER PACK	SIZE
L676RC	5	6 x 7/16 x .050

LENOX 810R BLADE



- Wood, compositions, plastic, cast aluminum, light non-ferrous metals & stainless steel
- TPI=10T

PART#	# PER PACK	SIZE
L810R	5	8 x 3/4 x .050"
L810RG	5 GOLD	8 x 3/4 x .050"
L810RQ	25 BULK	8 x 3/4 x .050"

LENOX 818R BLADE

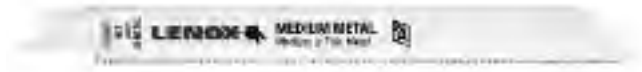

- Heavy gauge metal 1/8"-1/4" / 3.2-6mm, conduit & tubing, opening wood crates, removing wood siding or shingles
- TPI=18T

PART#	# PER PACK	SIZE
L818R	5	8 x 3/4 x .035"
L818RG	5 GOLD	8 x 3/4 x .035"
L818RQ	25 BULK	8 x 3/4 x .035"

TRADESMEN TOOLS

LENOX 850R BLADE



- Heavy duty. Extended life when cutting pipe, structural steel, stainless steel: 3/16"-3/4"/ 5- 20mm. Fire and rescue
- TPI= 10/14T

LENOX 956R BLADE



- Rough work in wood, fast cutting, used in remodeling and demolition work.
- TPI= 6T

PART#	# PER PACK	SIZE
L850R	5	8 x 3/4 x .050"
L850RQ	25 BULK	8 x 3/4 x .050"

PART#	# PER PACK	SIZE
L956R	5	9 x 3/4 x .050
L956RG	5 GOLD	9 x 3/4 x .050

LENOX 960R BLADE



- Demolition work in wood and metal. Fire and rescue.
- TPI= 10T

LENOX 966R BLADE



- Demolition work in nail-embedded wood.
- TPI= 6T

PART#	# PER PACK	SIZE
L960	2	9 x 7/8 x .062
L960RQ	25	9 x 7/8 x .062

PART#	# PER PACK	SIZE
L966R	2	9 x 7/8 x .062

LENOX 110R BLADE



- All woods, plastic, cast aluminum & light non-ferrous metals, stainless steel.
- TPI= 10/14T

LENOX 118R BLADE



- Heavy gauge metal 1/4"-1/2" /6-13mm, hard rubber, fiber & angle iron
- TPI= 18T

PART#	# PER PACK	SIZE
L110R	5	12 x 3/4 x .050
L110RQ	25 BULK	12 x 3/4 x .050

PART#	# PER PACK	SIZE
L118R	5	12 x 3/4 x .035

LENOX 156R BLADE



- Rough work in wood, fast cutting, used in remodeling and demolition work.
- TPI= 6T

ABRASIVE RECIPROCATING SAW BLADE



- 3/4" Width
- Fits most reciprocating saws
- Flexible alloy steel
- Diamond hard tungsten carbide grit makes this blade last up to 20 times longer than conventional blades

PART#	# PER PACK	SIZE
L156R	5	12 x 3/4 x .050
L156RG	5 GOLD	12 x 3/4 x .050
L156RQ	25 BULK	12 x 3/4 x .050

PART#	SIZE
L600RG	6"
L800RG	8"
L100RG	10"

TRADESMEN TOOLS

JIG SAW BLADE LENOX

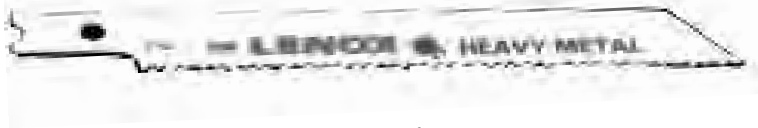

- 2 per pack

PART#	SIZE	TPI	CUTS THESE MATERIALS
L314J	3 x 3/8 x .037	14	Steels: 3/32" to 1/4" non-ferrous metal: 3/32" to 3/8"
L318J	3 x 3/8 x .037	18	Stainless steel, structural steel: 1/16" to 3/16"
L480J	4-1/2 x 3/8 x .050	10	Wood, nail-embedded wood: 1/4" to 2" thick. all steels: 1/8" to 1/2" soft metals: 1/8" to 1"
L406S	4-1/2 x 3/8 x .050	6	Fast, rough cutting in wood and composition material: 3/8" to 2" thick. chromium jig saw blade

SAW BLADES - BI-METAL PORTABLE BAND SAW



PART#	SIZE	TPI	CUTS THESE MATERIALS
L80146	53-3/4 x 1/2 x .025	10/14	1/4" & larger, metals, including stainless steel
L80147	53-3/4 x 1/2 x .025	14/18	1/8"- 5/16," metals, including stainless steel
L80112	44-7/8 x 1/2 x .023	14/18	1/8"- 5/16," most metals
L80142	44-7/8 x 1/2 x .025	14/18	1/8"- 5/16," metals, including stainless steel
L80144	44-7/8 x 1/2 x .025	10/14	1/4" & larger, metals, including stainless steel

VARI-BIT® STEP DRILL BITS



- High speed steel construction and steam oxide coating
- Two cutting flutes allow for clean burr-free holes. These bits will cut through materials faster than standard bits, including stainless steel up to 1/8" (3.2mm) thick

PART#	SIZE
LVB1	1/8" to 1/2"
LVB2	1/2" to 1"
LVB8	3/16" to 7/8"
LVB12	7/8" to 1-3/8"

WOOD BORING

WOOD HOLE CUTTER ONE TOOTH



- The LENOX® Advantage™ Patented Design 3 Times faster than regular hole saws
- Safer/less torque than self feed bits, therefore...
- Causes less fatigue on the user
- Can be run on lower power machines
- Can also run at higher speeds (1200 rpm)
- Easy plug ejection
- Cuts wet, frozen, pressure treated, and hard wood without binding (unlike self-feed bits)
- Resharpenable, cuts more than 300 holes before resharpening is even needed
- Deep enough to go through 2 x 4 and 3/4" plywood.

PART#	SIZE	APPLICATION
6920	2-1/8"	1-1/2" pipe, lock installation
6921	2-1/4"	1-1/2" pipe & 45°/90° bend couplings
6922	2-9/16"	2" pipe
6923	2-3/4"	2" pipe & 45°/90° bend couplings
6924	3-3/8"	3" duct pipe & bendable duct pipe
6925	3-5/8"	3" pipe
6926	4"	3" pipe & coupling, dryer vent
6927	4-5/16"	4" duct pipe & bendable duct pipe
6928	4-5/8"	4" pipe
6929	5"	4" pipe & coupling
6930		3/8" Stubby Spade Bit

LEADER BITS



LENOX® Leader® bits with their precision ground teeth and outside diameter threads are designed for automatic feeding. Forged body design and strong construction allow free-flow chip removal.

Leader bits cut very deeply, going through a 4x4 wooden beam without needing an extension and can be resharpened with a file.

PART#	SIZE	PIPE & RIGID CONDUIT	TUBING
LL100	1"	1/2"	7/8"
LL112	1-1/8"	1/2"	1"
LL125	1-1/4"	3/4"	1-1/8"
LL137	1-3/8"	1	1-1/4"
LL150	1-1/2"		1-3/8"
LL175	1-3/4"	1-1/4"	1-1/2"
LL200	2	1-1/2"	1-7/8"
LL212	2-1/8"		2"
LL256	2-9/16"	2	2-1/2"
L12LS		Lead Screw 5-PK	

TRADESMEN TOOLS

HOLE SAW - LENOX



PART#	SIZE	PART#	SIZE	PART#	SIZE	PART#	SIZE
L9L	9/16"	L21L	1-5/16"	L36L	2-1/4"	L56L	3-1/2"
L10L	5/8"	L22L	1-3/8"	L37L	2-5/16"	L58L	3-5/8"
L11L	11/16"	L23L	1-7/16"	L38L	2-3/8"	L60L	3-3/4"
L12L	3/4"	L24L	1-1/2"	L40L	2-1/2"	L62L	3-7/8"
L13L	13/16"	L26L	1-5/8"	L41L	2-9/16"	L64L	4"
L14L	7/8"	L27L	1-11/16"	L42L	2-5/8"	L66L	4-1/8"
L15L	15/16"	L28L	1-3/4"	L44L	2-3/4"	L68L	4-1/4"
L16L	1"	L29L	1-13/16"	L46L	2-7/8"	L70L	4-3/8"
L17L	1-1/16"	L30L	1-7/8"	L48L	3"	L72L	4-1/2"
L18L	1-1/8"	L32L	2"	L50L	3-1/8"	L76L	4-3/4"
L19L	1-3/16"	L33L	2-1/16"	L52L	3-1/4"	L80L	5"
L20L	1-1/4"	L34L	2-1/8"	L54L	3-3/8"	L88L	5-1/2"
						L96L	6"

**CARBIDE HOLE SAW
LENOX**



PART#	SIZE	TYPE
L12CT	3/4"	Carbide tip
L14CT	7/8"	Carbide tip
L16CT	1"	Carbide tip
L20CT	1-1/4"	Carbide tip
L22CT	1-3/8"	Carbide tip
L24CT	1-1/2"	Carbide tip
L28CT	1-3/4"	Carbide tip
L48CT	3"	Carbide tip
L58CT	3-5/8"	Carbide tip
L76CT	4-3/4"	Carbide tip

ARBORS FROM LENOX

LENOX 011L ARBOR



- Shank= HEX
- Chuck=1/2" & Larger

PART# FITS HOLE SAW

L011L L9L-L19L

LENOX 011SL ARBOR



- Shank= SDS
- Chuck= -

PART# FITS HOLE SAW

L011SL L9L-L19L

LENOX 022L ARBOR



- Shank= HEX
- Chuck= 1/2" & Larger

PART# FITS HOLE SAW

L022L L20L-L96L

LENOX 022SL ARBOR



- Shank=SDS
- Chuck= -

PART# FITS HOLE SAW

L022SL L20L-L96L

LENOX 033L ARBOR



- Shank=SOLID / HEX
- Chuck= 1/2" & Larger

PART# FITS HOLE SAW

L033L L20L-L96L

LENOX 044L ARBOR



- Shank=3 SIDED
- Chuck= 1/4" & Larger

PART# FITS HOLE SAW

L044L L9L-L19L

LENOX ARBORS & TOOLS

LENOX 055L ARBOR



- Shank= HEX
- Chuck= 3/8" & Larger

PART#	DESCRIPTION
L055L	L9L-L19L

LENOX 066L ARBOR



- Shank= HEX
- Chuck= 3/8" & Larger

PART#	DESCRIPTION
L066L	L20L-L96L

LENOX 077L ARBOR



- Shank= HEX
- Chuck= 3/8" & Larger

PART#	DESCRIPTION
L077L	L24L-L96L

**ARBOR PILOT DRILLS
LENOX**



PART#	# IN PACK	DESCRIPTION
L4321	Pilot drill 10 pack	L011L, L022L, L044L
LB4321	Pilot drill 25 pack	L011L, L022L, L044L
L56PD	Pilot drill 1 pack	L011SL, L022SL, L033L, L055L, L066L, L077L

**HOLE SAW (BI-METAL)
PLUMBER KIT - LENOX**



- PLUMBER KIT, small 6pcs
Contains holesaws:
- 3/4" to 2-1/4"
- PLUMBER KIT, Large, 12pcs
Contains holesaws:
- 3/4" to 4-1/2"
- 12 hole saws

PART#	DESCRIPTION
L600P	Plumbers kit - small (6 pcs)
L1200P	Plumbers kit, large (12 pcs)

**HOLE SAW (BI-METAL)
BIG DADDY KIT - LENOX**



- BIG DADDY KIT
- Contains holesaws:
3/4", 7/8", 1", 11/8", 13/8", 11/2", 13/4", 2", 21/8", 21/4", 21/2", 211/16", 3", 31/4", 33/8", 35/8", 33/4", 41/8", 41/2", 43/4" (19, 22, 25, 29, 35, 38, 44, 51, 54, 57, 64, 68, 76, 83, 86, 92, 95, 105, 114, 121mm). Arbors: 1L, 2L, 5L.
 - Two 4321 and one 56PD pilot drills.

PART#	DESCRIPTION
L2000G	Big daddy kit

TRADESMEN TOOLS

COB PIPE FREEZING SYSTEM



The COB pipe freezing system by LYNCAR, is a jacket system using CO². Available from 1/2" to 8" jackets. Tanks sold separately.

You can rent CO² tanks from your local gas supplier dealer. By wrapping the jacket around the pipe of stagnant water, then applying CO², this will form dry ice, in turn freezing the water causing an ice plug

- All kits are supplied with carrying case, jackets, hoses, connections for tank, instructions, mallet & gloves and timing pad. You may increase the size of your kit anytime, we offer all items separately, please call LYNCAR for details

PART#	DESCRIPTION
QF1500	Freeze kit 3/8" to 1-1/2" pipe
QF2000	Freeze kit 3/4" to 1-1/2" pipe
QF2200	Freeze kit 3/8" to 1-1/2" pipe (double freeze)
QF3000	Freeze kit 3/8" to 3" pipe
QF4000	Freeze kit 3/8" to 4" pipe
QFAL20	Alum. tank w/ tube 20lb

ROFROST CO2 PIPE FREEZING UNIT



- Simple, quick, safe freezing using carbon dioxide
- No CFC's
- Copper tubes 10 - 60 mm OD 1/2" - 2 1/8" OD steel pipes 1/8" - 2" OD
- Economic and environmentally friendly option for the plumbing and heating engineer when servicing, repairing or extending pipe systems, without the need for time consuming draining down
- Good for customer relations – no prolonged discussion about when to do the job, and no inconvenience is caused to third parties not involved by having to have their water turned off
- Ideal when replacing faulty parts, e.g. thermostatic regulator valves etc
- Eliminates the risk of air-locks heating systems.

PART#	DESCRIPTION
R65030	ROFROST CO2 Pipe Freezing Unit

TRI STAND MAXPOWER



- Comparable to:
- RIDGID™ 460
 - BERKLEY™ BT335, BT333
 - Ships fully assembled
 - Chain vise stand tri-stand vise has folding lower tray for ease of transporting, while providing additional workspace to hold tool, or oil cans within convenient reach
 - Vise base has integral pipe rest and pipe bending slots and hardened replaceable jaws
 - Parts interchangeable with competitive style units

PART#	DESCRIPTION
MP200	Tri Stand