

# Nuvo<sup>®</sup>

Designed by Audiophiles.  
Installed by Professionals.



 legrand<sup>®</sup>

# A HISTORY OF EXCELLENCE.

1924

Nuvo begins as the Davitt & Hanser Music Company. Later renamed Hanser Holdings International (HHI), Nuvo has become one of the most trusted names in music manufacturing and distribution.



1989

HHI acquires the world-renowned music amplification and engineering company Kustom.

1991

Kustom introduces the first integrated whole home audio system under the name Kustom Home Sound.



2002

HHI launches Nuvo, the new brand name of Kustom Home Sound.

2012

Legrand, North America acquires Nuvo. Today, Nuvo continues to deliver unparalleled innovations in sound.



## DESIGNED BY AUDIOPHILES.

Nuvo, the award-winning product line of Legrand, specializes in advanced whole home audio systems and solutions that deliver a truly unparalleled listening experience. With a deep-seated passion for music and an audio lineage reaching back to 1924, Nuvo was born of the Kustom Home Sound brand, the same company that delivered stage amplification for professional musicians ranging from Johnny Cash to Quiet Riot. Today, Nuvo continues to deliver innovative, high-performing products for professional home audio installations.

# PLAYER PORTFOLIO.

Designed with the professional installer in mind, the flexible, powerful Player Portfolio system delivers incredible high-fidelity audio to every room of the home. Conveniently available in wired or wireless configurations, the single zone Players and multi-zone rack-mount Players make it easy to build a unified whole home audio experience in up to 16 different zones. Easy to install and even easier to enjoy, the Player Portfolio offers an unparalleled listening experience with endless music options at your fingertips.

# EXPLORE A WORLD OF MUSIC.

The Player Portfolio offers true listening freedom with built-in access to endless music options - from networked audio content and iTunes libraries, to an expansive variety of Internet radio and streaming services. Whether it's an old favorite or the newest hit, your home will be filled with the music that moves you.



# THE PLAYER ECOSYSTEM.

Simply connect a Nuvo Player to the home network and your favorite speakers. To start listening, use the free Player Portfolio app to quickly connect and set up the system. Easily expand home audio to other rooms by adding Players in other zones.

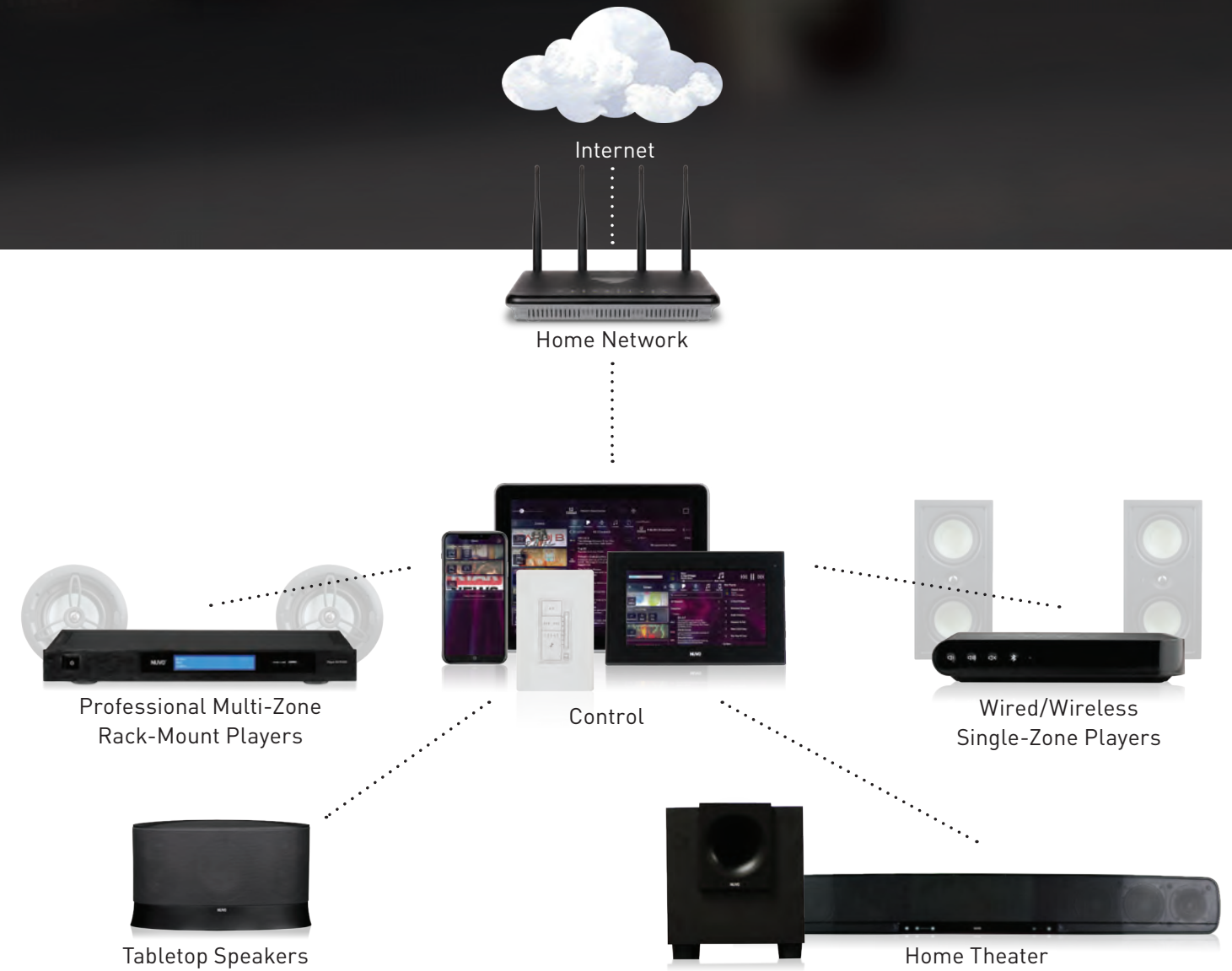

# COMPLETE CONTROL.

## Nuvo Player App

Nuvo makes it easy to get right to the music you love with the intuitive Player app. By automatically displaying your favorite music services and artists, it allows fast, simple browsing with a world of music available right at your fingertips. Play different songs in every room, or stay in perfect sync when broadcasting a single song throughout the home.



## NUVO PLAYER APP

Manage music library, power, and playlists, as well as Play, Pause, Volume, Mute, Skip Track, and more

Choose music from an unlimited variety of sources

Easy browsing by song, album, genre, and artist

Control music in every zone or group together to play one song throughout the home

Download app for free from iTunes and Google Play

## In-Wall Keypads and Touch Screen

Enjoy intuitive control where you need it most with the Nuvo Touchscreen and Keypads. With a fixed on-wall location, these devices add a whole new layer of convenience to the Player Portfolio system, providing instant access to music for anyone in the home. Installation is a breeze with a single PoE connection.



## P30 TOUCH SCREEN

Wall-mounted tablet runs the Nuvo Player app for complete management of all zones, sources, and audio functions

Sleek, high contrast 7" Android 1024 x 600 IPS capacitive touch screen

Connects easily with a single RJ45 802.11 af PoE cable

Universal mounting plate for quick installation

Available in both black and white

## P20 KEYPAD

Capacitive touch backlit display provides accessible in-wall control of a single zone

Control Play, Pause, Volume, and Track Navigation

A single button allows quick access to 5 preset favorites

Connects easily with a single RJ45 802.11 af PoE cable

Designed for Livinglight, Arteur and Valena Life wall plates available throughout Europe and adorne wall plates in North America.



## P10 KEYPAD

Convenient in-wall control of a single zone

Control Play, Pause, Volume, Mute, and Track Navigation

A single button allows quick access to 5 preset favorites

Connects easily with a single RJ45 802.11 af PoE cable

Available in white, light almond and nickel



# PROFESSIONAL FINISH. PROFESSIONAL POWER.

## Professional Multi-Zone Rack Mount Players

Deliver a powerful experience with Nuvo's high-performing, professionally-installed multi-zone players. These sleek rack mount A/V units occupy 1U of rack space, but cover three listening zones for a clean installation with maximum efficiency. Hard-wire multiple players with Ethernet for centralized integration.



### P3100 PROFESSIONAL SERIES PLAYER

3 zone, with 40-watts per zone at 8 ohms

High-performance amplifier operates coolly and saves energy while minimizing distortion

Rack mount ears included

#### P3100 Specifications

Power	20w per channel @ 8 ohms
Network	Wired
# of Zones	3
# of Channels	2 per zone
Input	3.5mm x 3, USB x 3
Preamp Output	3.5mm x 3



### P3500 PROFESSIONAL SERIES PLAYER

3 zone, with 100-watts per zone at 8 ohms

Extreme power efficiency for superior amplification, featuring Bang and Olufsen's intelligent ICEpower® audio technology

Connect additional components via RCA line in/out

Rack mount ears included

#### P3500 Specifications

Power	50w per channel @ 8 ohms 100w per channel @ 4 ohms
Network	Wired
# of Zones	3
# of Channels	2 per zone
Input	RCA x 3, USB x3
Preamp Output	RCA x 3



### P4300 PROFESSIONAL SERIES PLAYER

Highest quality rack mount player with DSP for enhanced performance

3 zone, with 110-watts per zone at 4, 6 or 8 ohms (ohm load is selectable within the app)

Backlit touch screen supports easy setup with visible system status, zone names, and more

Large side-mounted heat sinks and no fans for convenient single-space rack mounting

3.5mm combination analog/TOSLINK jacks for line inputs and outputs

Rack mount ears included

#### P4300 Specifications

Power	55w per channel @ 4,6, or 8 ohms
Network	Wired
# of Zones	3
# of Channels	2 per zone
Input	Auto-sensing 3.5mm analog or optical x 3 (Toslink to 3.5mm adapters included), USB x 3
Preamp Output	Auto-sensing 3.5mm analog or optical x 3 (Toslink to 3.5mm adapters included)



P3100



P3500



P4300

# FLEXIBLE SOLUTIONS.

## Wired/Wireless Single-Zone Players

Introduce incredible audio into hard-to-wire spaces with Nuvo wireless single-zone players. Ideal for easily adding zones to an existing Player Portfolio System, single-zone players support both wired Ethernet or Wireless 802.11a/b/g/n configuration options for optimal flexibility.



### P100 PLAYER AMPLIFIER

Give any room instant access to endless music options, or stay perfectly in sync when all zones are playing the same song

Provides a total 40 watts of power at 8 ohms to a single zone

#### P100 Specifications

Power	20w per channel @ 8 ohms
Network	Ethernet or Wireless 802.11a/b/g/n
# of Zones	1
# of Channels	2
Inputs	3.5mm, USB
Output	3.5mm

### P200 PLAYER AMPLIFIER

Instant access to endless music options, or stay perfectly in sync when all zones are playing the same song

Connect to any Bluetooth-enabled device to listen instantly

Provides a total 120 watts of power at 8 ohms to a single-zone



#### P200 Specifications

Power	60w per channel @ 8 ohms stable
Network	Ethernet or Wireless 802.11a/b/g/n
# of Zones	1
# of Channels	2
Inputs	3.5mm, Bluetooth, USB
Output	3.5mm



### P300 PLAYER PREAMPLIFIER

Designed for maximum versatility, connect to any external amplifier or receiver to create a fully functioning zone

Offers all the benefits of Player Portfolio including expansive source variety, convenient app control, and stunning hi-fi quality

#### P300 Specifications

Power	Unpowered
Network	Ethernet or Wireless 802.11a/b/g/n
# of Zones	1
Inputs	Auto-sensing 3.5mm analog or optical (Toslink to 3.5mm adapters included), USB
Output	Auto-sensing 3.5mm analog or optical (Toslink to 3.5mm adapters included)



P100



P200



P300

# EXCEPTIONAL EXPERIENCES.

## Tabletop Speaker

Stream music to any room with this all-in-one stereo speaker and amplifier, or easily expand an existing Player Portfolio system with an additional zone of audio. With a powerful 2.1 system, the P400 fills any room with rich, full-bodied sound, and stays perfectly in sync with other zones playing the same song. Blending premium performance with installation flexibility, the tabletop speaker makes it easier than ever to listen to the music you love - whenever or wherever you might want to listen.



## P400 TABLETOP SPEAKER

All-in-one single-zone amplifier and stereo speaker easily expands the Player Portfolio system

Powerful 2.1 system with 5 1/4" subwoofer, two midrange drivers, and two tweeters

Conveniently controlled with the Nuvo Player app and optional in-wall keypads

Capacitive touch controls on the device provide Play, Pause, Volume, Mute, and Track Navigation

Wired or wireless connection allows for flexible installation

## P400 Specifications

Network	Ethernet or Wireless 802.11a/b/g/n
# of Zones	1
Input	3.5mm analog
Dimensions	368 W x 217 H x 149 D (mm) 14.5 W x 8.56 H x 5.88 D (in)

## Sound Bar and Subwoofer

Merging the exceptional audio quality of Player Portfolio with dynamic home theater technology, the P500 delivers a cinematic experience that true audiophiles will love. With a powerful 2.1 system, complete with an 8" wireless subwoofer, the Sound Bar boosts listening experiences, playing movie, TV, or game audio in brilliant clarity. Better yet, the P500 is a single-zone Player Portfolio amplifier, granting access to networked music collections and endless streaming services. With convenient control options and simple setup, the Sound Bar delivers an immersive audio experience to complete any home theater.

## P500 PLAYER SOUND BAR AND SUBWOOFER

All-in-one single-zone Player Portfolio amplifier and home theater Sound Bar

Powerful 2.1 system complete with 8" wireless subwoofer

Conveniently controlled with the included IR remote, Nuvo Player app, optional in-wall keypads, or the capacitive touch controls

Customized listening modes for music, movie, voice, and night

Mounting bracket included

## P500 Specifications

Network	Ethernet or Wireless 802.11a/b/g/n
# of Zones	1
Inputs	RCA, Toslink, USB
Sound Bar Dimensions	877 W x 115 H x 108 D (mm) 34.5 W x 4.25 H x 4.5 D (in)
Subwoofer Dimensions	231 W x 261 H x 303 D (mm) 9.1 W x 10.25 H x 11.9 D (in)



# SIMPLIFIED STREAMING.

## DIN Rail Solutions

Nuvo's P600 Player is the world's first streaming music player designed for the international DIN rail mounting standard. It gives any room instant access to endless audio options with built in access to personal music collections, internet radio, or popular streaming services. Compatible with all other products in Nuvo's Player Portfolio, the P600 adds ease of installation and flexibility to expand the system. It is powered by the P601 Power Supply which can be used to power up to four P600 Players.

### P600 DIN RAIL PLAYER

Designed for the international DIN rail mounting standard and compatible with all products in the Player Portfolio

Give any room instant access to endless music options or stay perfectly in sync when all zones are playing the same song

Provides a total of 40 watts of power at 4/6/8 ohms to a single zone

Conveniently controlled with the Nuvo Player app or optional in-wall keypads



#### P600 Specifications

Power	20w per channel. 4,6, or 8 ohms stable
Network	Ethernet
# of Zones	1
# of Channels	2
Inputs	3.5mm, USB

### P601 DIN RAIL POWER SUPPLY

Powers up to four P600 players

Designed for international DIN rail mounting for flexible and efficient installation

#### P601 Specifications

Power	24V / 18w per zone
# of Zones Powered	4



\* The P600 and P601 will be sold internationally to support the DIN rail mounting standard.

# DYNAMIC DELIVERY.

## Digital Power Amplifiers

Nuvo class-D digital power amplifiers provide standalone power with incredible performance. These rack mount units offer clean, crisp sound with low distortion and minimal signal loss. High-efficiency design achieves ENERGY STAR standard for utilizing less than one watt of power in standby mode. With easy third party integration and a clean 1U installation, providing music the way it should be heard couldn't be easier.

### D460 DIGITAL POWER AMPLIFIER

Powerful four channel stereo amplification

4 or 8 ohm selectable rating offers optional configurations

#### D460 Specifications

Power	4 x 60w (4 or 8 ohm)
# of Channels	4
Ohms	4 or 8 ohm
Input	RCA



### D2120 DIGITAL POWER AMPLIFIER

Powerful two channel stereo amplification

4 or 8 ohm selectable rating offers optional configurations

#### D2120 Specifications

Power	2 x 120w (4 or 8 ohm)
# of Channels	2
Ohms	4 or 8 ohm
Input	RCA



# INSTALLER-INSPIRED DESIGN.

## Professional Solutions

Dedicated to engineering innovative multi-room audio solutions, every product and system feature in the Nuvo Player Portfolio line is designed with meticulous detail to support the needs of professional integrators. From flexible wired or wireless configurations and simple set-up, to seamless third-party integration and effortless control, Player Portfolio is the all-in-one solution for dynamic whole home audio.

## Seamless Integration

With pre-written drivers, it's easy to integrate the exceptional audio of Nuvo into advanced control systems from Vantage, Control4, Elan, Crestron, KNX, and more. **View the full list of integration partners: [legrand.us/nuvo-integration](http://legrand.us/nuvo-integration)**

Control4

ELAN

RTI

KNX

VANTAGE

CRESTRON

UIC



## Professional Rack-Mount Solutions

Nuvo's professional rack-mount Players provide a cleaner installation with a more efficient use of space in the AV rack.

## Flexible System Design

The Player Portfolio offers a comprehensive line of scalable home audio products available in wired or wireless configurations. Flexible options including the home theater sound bar and tabletop speaker make it simple to specify the right solution for any project.









## Remote Monitoring and Device Management

Domotz PRO network management software simplifies installations and allows remote monitoring, tech support, and troubleshooting of Nuvo devices from anywhere – saving installers time, adding value, and improving efficiency.

## A Spare-No-Expense Attitude on Audio Quality

Offering a reproduction quality that is true to every artist and song, Player Portfolio supports true 24 bit/192 kHz high-resolution streaming audio – the way sound was meant to be heard.



	Single Zone Players			All-In-One Speaker/Player		Multi-Zone Players			DIN rail Player
									
Model	P100	P200	P300	P400	P500	P3100	P3500	P4300	P600
Size Dimension H x W x D	42 x 187 x 115 (mm) 1.65 x 7.36 x 4.5 (in)	42 x 229 x 127 (mm) 1.65 x 9 x 5 (in)	38 x 145.5 x 90.5 (mm) 1.5 x 5.7 x 3.56 (in)	216 x 375 x 152 (mm) 8.5 x 14.76 x 5.98 (in)	Sound Bar 108 x 877 x 115 (mm) 4.25 x 34.5 x 4.52 (in) Subwoofer 235 x 231 x 303 (mm) 9.25 x 9 x 11.9 (in)	44 x 430 x 250 (mm) 1.73 x 16.9 x 9.8 (in)	44 x 430 x 250 (mm) 1.73 x 16.9 x 9.8 (in)	54 x 430 x 258 (mm) 1.73 x 16.9 x 10.1 (in)	53.4 x 90 x 67.2 (mm) 2.102 x 3.543 x 2.646 (in)
Power (watts)	40 (8ohm, 20w x 2)	120 (4ohm, 60w x 2)	preamplifier	closed system	closed system	3 zones x 40 (8ohm, 20w x 2 per zone)	3 zones x 100 @ 8ohm (8ohm, 50w x 2 per zone)	3 zones x 110 @ 4, 6, or 8ohm	40 (4, 6, or 8ohm, 20w x 2)
Generation D Energy-Efficient Amplifier	■	■	-	■	■	■	■	■	■
Domotz Ready	■	■	■	■	■	■	■	■	■
Apple / Android Control App	■	■	■	■	■	■	■	■	■
Wi-Fi	■	■	■	■	■	-	-	-	-
Ethernet Connection	■	■	■	■	■	■	■	■	■
Analog Line In	■	■	■	■	■	■	■	■	■
Analog Line Out	■	■	■	-	-	■	■	■	-
Optical In	-	-	■	-	■	-	-	■	-
Optical Out	-	-	■	-	-	-	-	■	-
USB Port	■	■	■	■	■	■	■	■	■
Bluetooth	-	■	-	-	-	-	-	-	-
ICEpower® audio technology	-	-	-	-	-	-	■	-	-
Four Ohm Stable	-	-	-	-	-	-	■	■	■
DSP	-	-	-	■	-	-	-	■	-
Trigger In	-	-	-	-	-	-	-	-	-
Trigger Out	-	-	-	-	-	■	■	■	-
Power-up Options	-	-	-	-	-	-	-	-	-

# UNPRECEDENTED PERFORMANCE.

## Nuvo Speakers

Be heard and not seen with Nuvo's line of professionally-installed, built-in speakers. Designed with the same level of quality as our high-performing audio systems, Nuvo speakers' impeccable sound quality satisfies even the most discriminating audiophile. Even better, Nuvo speakers are specially designed to fit every space, project, and price point.

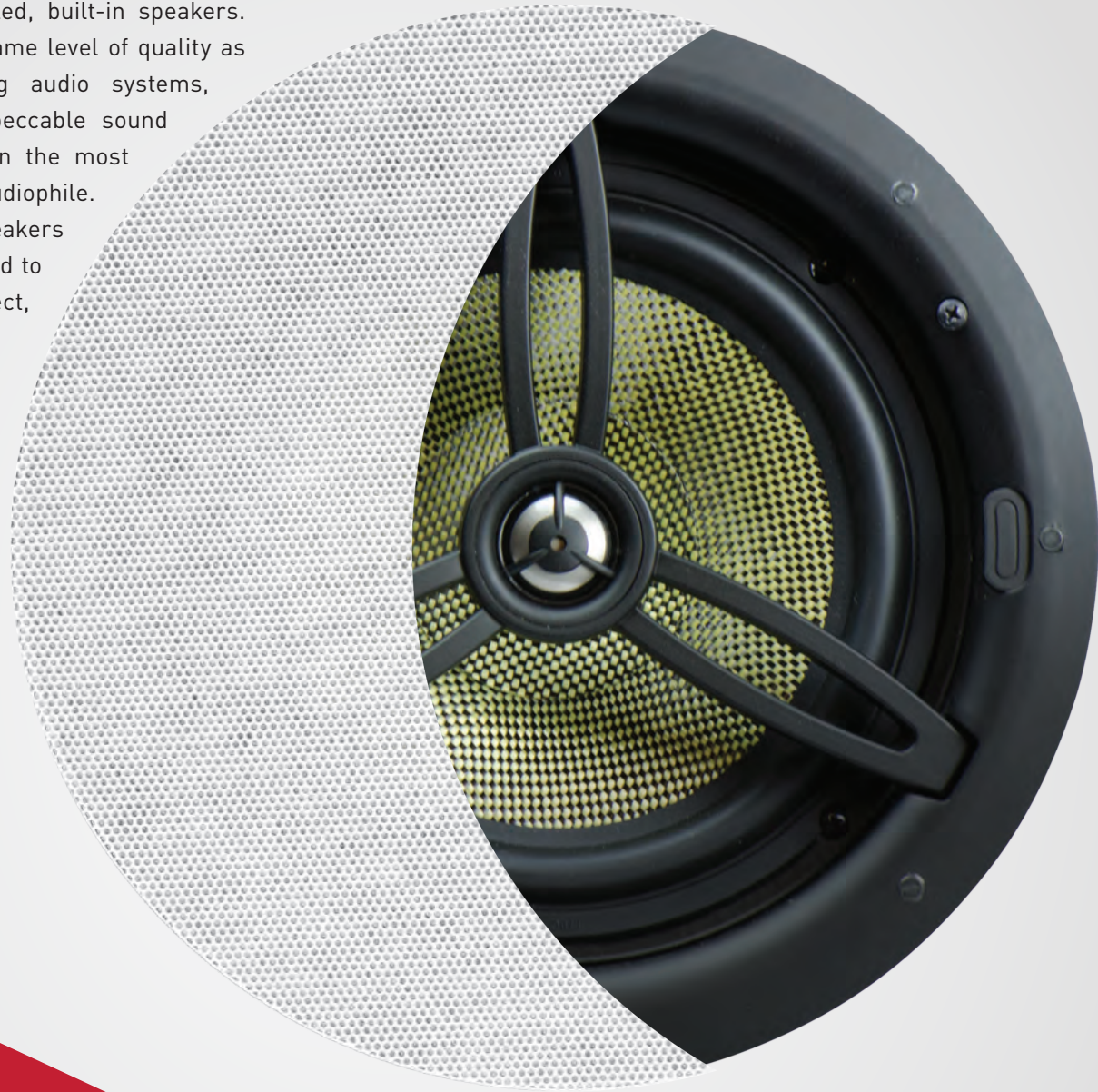

## SERIES TWO BALANCED

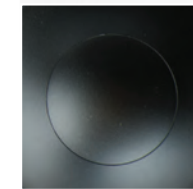

Series Two woofers are constructed with high-grade polymer for deep bass.

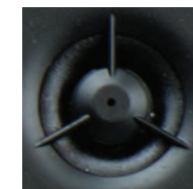

Series Two tweeters are made from silk for smoother highs.

## SERIES FOUR ENHANCED

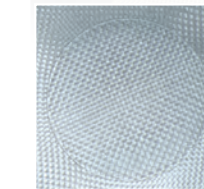

Series Four woofers are constructed with glass fiber for minimal distortion.



Series Four tweeters are made from aluminum for brighter sound.

## SERIES SIX PREMIUM

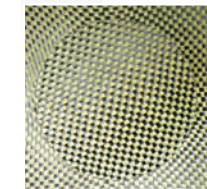

Series Six woofers are constructed of Kevlar® and carbon fiber to handle the heaviest loads.

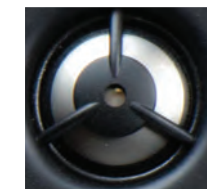

Series Six tweeters are made from titanium for ultimate performance.

# BALANCED

## SERIES TWO SPEAKERS

Designed to deliver balanced, moderate sound

Polypropylene woofers are constructed with high-grade polymer for a rich, deep bass

Pivoting dome tweeters are made from silk for smooth smart highs

Power Handling: 100w peak/ 50w RMS with 8 ohms



### Series Two Specifications

Power Handling	100w peak / 50w RMS
Efficiency	86dB
Resistance	8 ohm
Tweeter Construction	silk
Woofer Construction	poly



NV-2IC6  
Series Two 6.5" In-Ceiling Speaker



NV-2IC6-ANG  
Series Two 6.5" In-Ceiling Angled Speaker



NV-2IC6-DVC  
Series Two 6.5" In-Ceiling Dual Voice Coil Speaker



NV-2IC8  
Series Two 8" In-Ceiling Speaker



NV-2IC8-ANG  
Series Two 8" In-Ceiling Angled Speaker



NV-2IW6  
Series Two 6.5" In-Wall Speaker



NV-2IW5-LCR  
Series Two 5.25" In-Wall LCR Speaker



NV-2OD5-BK & NV-2OD5-WH  
Series Two 5.25" Outdoor Speaker (Available in Black and White)

NV-2OD6-BK & NV-2OD6-WH  
Series Two 6.5" Outdoor Speaker (Available in Black and White)

# ENHANCED

## SERIES FOUR SPEAKERS

Remarkable striking clarity

Woofers are designed with glass fiber for minimal distortion

Pivoting dome tweeters are made from aluminum for a brighter, clearer sound

Power Handling: 150w peak/ 75w RMS with 8 ohms

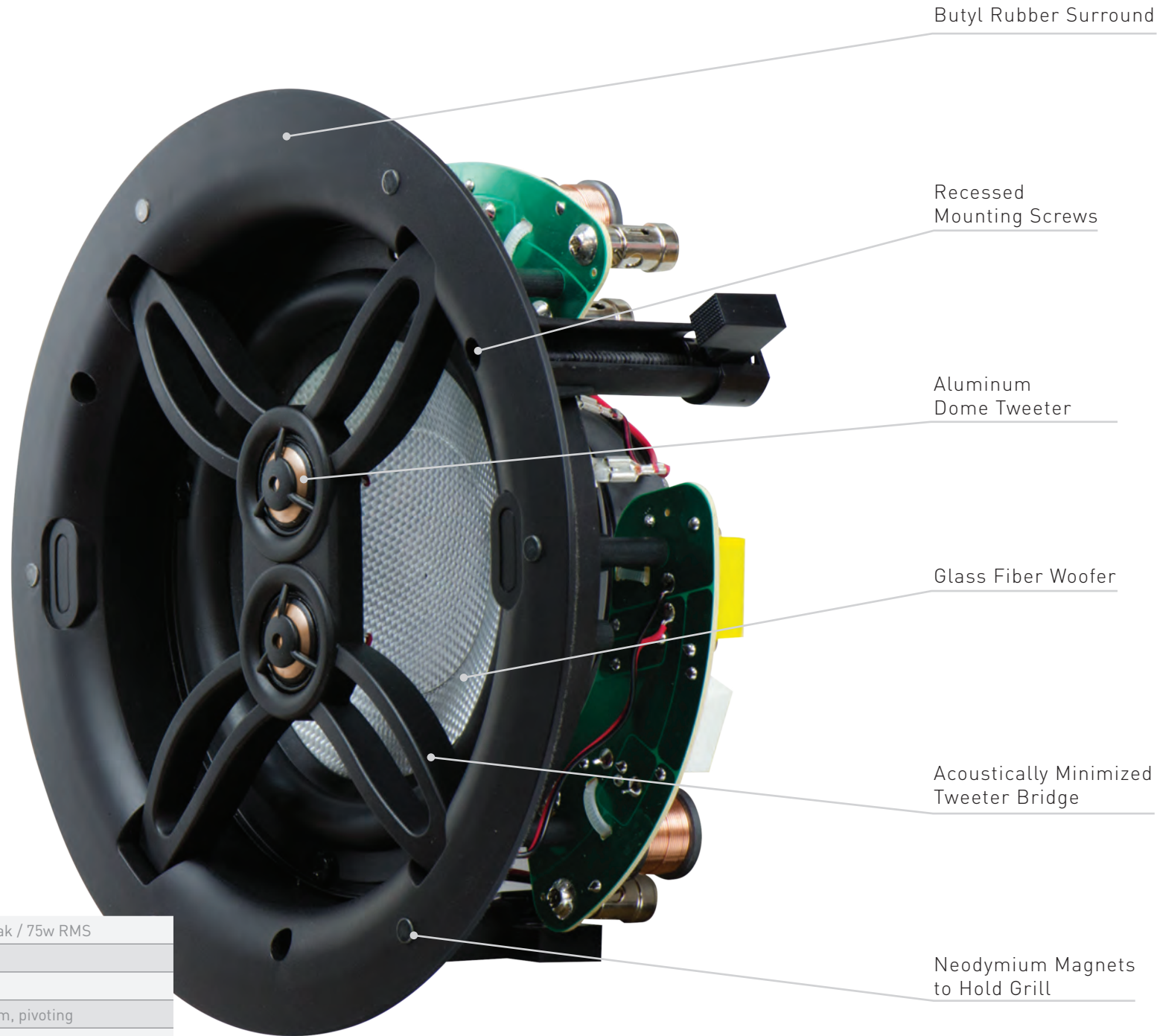

### Series Four Specifications

Power Handling	150w peak / 75w RMS
Efficiency	88dB
Resistance	8 ohm
Tweeter Construction	aluminum, pivoting
Woofer Construction	glass fiber

Butyl Rubber Surround

Recessed Mounting Screws

Aluminum Dome Tweeter

Glass Fiber Woofer

Acoustically Minimized Tweeter Bridge

Neodymium Magnets to Hold Grill



NV-4IC6  
Series Four 6.5" In-Ceiling Speaker



NV-4IC6-ANG  
Series Four 6.5" In-Ceiling Angled Speaker



NV-4IC6-DVC  
Series Four 6.5" In-Ceiling Dual Voice Coil Speaker



NV-4IC8  
Series Four 8" In-Ceiling Speaker



NV-4IC8-ANG  
Series Four 8" In-Ceiling Angled Speaker



NV-4IW6  
Series Four 6.5" In-Wall Speaker



NV-4IW5-LCR  
Series Four 5.25" In-Wall LCR Speaker

# PREMIUM

## SERIES SIX SPEAKERS

The highest power handling and most extreme performance for home theater and vast spaces

Woofers are constructed of Kevlar and carbon fiber, for strength to carry to heaviest loads

Pivoting dome tweeters are made from titanium for ultimate performance, delivering smooth, lifelike vocals and crystal-clear highs

Outfitted with tweeter level adjustment for advanced audio customization

Power Handling: 200w peak/ 100w RMS with 8 ohms

### Series Six Specifications

Power Handling	200w peak / 100w RMS
Efficiency	89dB
Resistance	8 ohm
Tweeter Construction	titanium
Woofer Construction	carbon fiber and Kevlar®

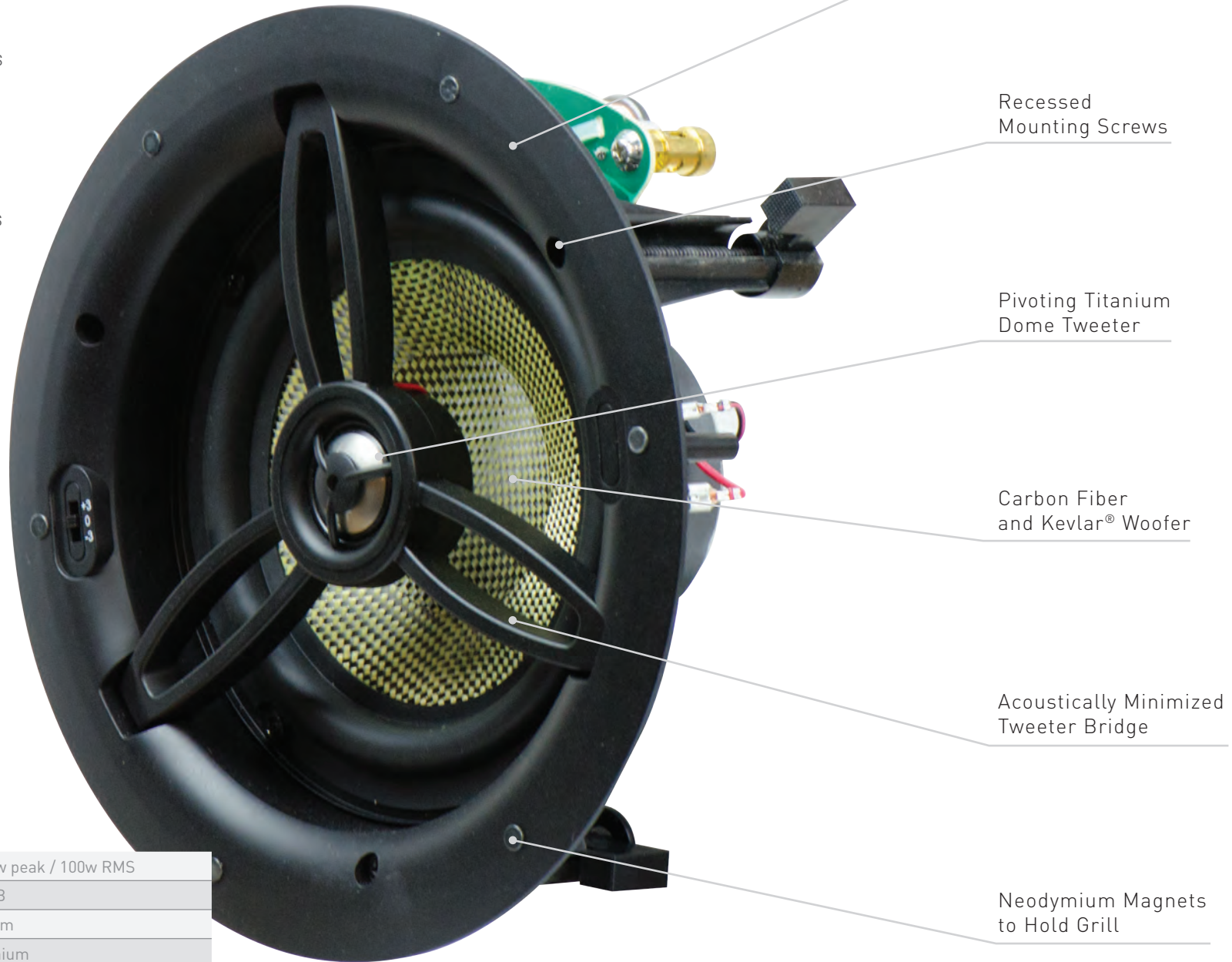

Butyl Rubber Surround

Recessed Mounting Screws

Pivoting Titanium Dome Tweeter

Carbon Fiber and Kevlar® Woofer

Acoustically Minimized Tweeter Bridge

Neodymium Magnets to Hold Grill



NV-6IC6  
Series Six 6.5" In-Ceiling Speaker



NV-6IC6-ANG  
Series Six 6.5" In-Ceiling Angled Speaker



NV-6IC8  
Series Six 8" In-Ceiling Speaker



NV-6IC8-ANG  
Series Six 8" In-Ceiling Angled Speaker



NV-6IW6  
Series Six 6.5" In-Wall Speaker



NV-6IW6-LCR  
Series Four 6.5" In-Wall LCR Speaker

NV-60D5-BK & NV-60D5-WH  
Series Six 5.25" Outdoor Speaker (Available in Black and White)

NV-60D6-BK & NV-60D6-WH  
Series Six 6.5" Outdoor Speaker (Available in Black and White)



NV-60D5-DVC-BK & NV-60D5-DVC-WH  
Series Six 5.25" Outdoor Dual Voice Coil Speaker (Available in Black and White)

NV-60D6-DVC-BK & NV-60D6-DVC-WH  
Series Six 6" Outdoor Dual Voice Coil Speaker (Available in Black and White)

# IMMERSIVE OUTDOOR AUDIO.

## Landscape Speakers

Deliver dynamic sound quality through any outdoor environment with the durable and scalable Series Two Landscape Speakers. The low-profile, black teardrop satellite speakers have 3.5" poly woofers and .5" UFLC tweeters for clear, robust audio and even coverage. The powerful 8" buried subwoofer blends subtly into the landscape while providing a stand-out bass response. Designed for years of performance, the Landscape Speakers are rated for outdoor use and durability in extreme weather conditions.

## LANDSCAPE SPEAKERS

Complete 5-piece system comes with 4 two-way satellite speakers and an 8" in-ground subwoofer

IP-67 and MIL-STD-810 compliant

8 ohm system pairs perfectly with Player Portfolio products or any 8 ohm amplifier

Highly scalable with option to add-on additional satellite speakers

Lifetime Warranty

### Landscape Series Two Specifications

Power Handling	280w
Efficiency	86dB
Resistance	8 ohm
Tweeter Construction	UFLC
Woofers Construction	poly



## Outdoor Speakers

Elevate exterior living spaces with Series Two and Series Six Outdoor Speakers. The sleek enclosure boasts a modern form and minimal size that tastefully blend with the lines of any home. They deliver a clean, powerful sound and are rated for outdoor use. Designed for easy installation, the speaker safely rests on the bracket with mounting knobs loosely installed to allow flexibility while wiring the removable phoenix connector. After the terminal has been secured, simply adjust the angle, tighten knobs, install covers, and mounting is complete.

## OUTDOOR SPEAKERS

Delivers clear, powerful sound to exterior spaces

IP65 and MIL-STD-810 rated

Designed for safe and easy installation

8 ohm rated

Available in black and white

Lifetime Warranty

### Outdoor Series Two Specifications

Power Handling	100w peak / 50w RMS
Efficiency	87dB
Resistance	8 ohm
Tweeter Construction	UFLC
Woofers Construction	poly

### Outdoor Series Six Specifications

Power Handling	120w peak / 60w RMS
Efficiency	88dB
Resistance	8 ohm
Tweeter Construction	titanium
Woofers Construction	carbon fiber and Kevlar®



# ARCHITECTURAL SPEAKERS

## SERIES TWO

**Impedance**  
8 Ohms

**Sensitivity**  
86dB

**Power**  
50w RMS / 100w Peak

**Woofer Material**  
Poly

**Tweeter Material**  
Silk



NV-21C6



NV-21C6-ANG



NV-21C6-DVC



NV-21C8



NV-21C8-ANG



NV-21W6



NV-21W5-LCR

Overall Dimensions	9.06" / 230mm	9.06" / 230mm	9.06" / 230mm	10.63" / 270mm	11.22" / 285mm	8.66" x 11.81" / 220mm x 300mm	7.48" x 15.35" / 190mm x 390mm
Cutout Dimensions	8.07" / 205mm	8.07" / 205mm	8.07" / 205mm	9.68" / 246mm	10.15" / 258mm	7.6" x 10.79" / 194mm x 274mm	6.41" x 14.3" / 163mm x 363mm
Woofer Size	6.5"	6.5"	6.5"	8"	8"	6.5"	5.25"
Tweeter Size	0.5"	0.5"	0.5"	0.5"	0.5"	0.5"	0.5"
Mounting Depth	3.9" / 99mm	4.57" / 116mm	3.9" / 99mm	4.37" / 111mm	5.31" / 135mm	3.27" / 83mm	3.35" / 85mm
Frequency Response	60Hz - 20KHz	60Hz - 20KHz	55Hz - 20KHz	45Hz - 20KHz	45Hz - 20KHz	60Hz - 20KHz	65Hz - 20KHz
Shipping	Pair	Single	Single	Pair	Single	Pair	Single

## SERIES FOUR

**Impedance**  
8 Ohms

**Sensitivity**  
88dB

**Power**  
75w RMS / 150w Peak

**Woofer Material**  
Glass Fiber

**Tweeter Material**  
Aluminum



NV-41C6



NV-41C6-ANG



NV-41C6-DVC



NV-41C8



NV-41C8-ANG



NV-41W6



NV-41W5-LCR

Overall Dimensions	9.06" / 230mm	9.06" / 230mm	9.06" / 230mm	10.63" / 270mm	11.22" / 285mm	8.66" x 11.81" / 220mm x 300mm	7.48" x 15.35" / 190mm x 390mm
Cutout Dimensions	8.07" / 205mm	8.07" / 205mm	8.07" / 205mm	9.68" / 246mm	10.15" / 258mm	7.6" x 10.79" / 194mm x 274mm	6.41" x 14.3" / 163mm x 363mm
Woofer Size	6.5"	6.5"	6.5"	8"	8"	6.5"	5.25"
Tweeter Size	0.75"	0.75"	0.75"	0.75"	0.75"	0.75"	0.5"
Mounting Depth	3.94" / 100mm	4.76" / 121mm	3.94" / 100mm	4.41" / 112mm	5.55" / 141mm	3.27" / 83mm	3.35" / 85mm
Frequency Response	55Hz - 20KHz	55Hz - 20KHz	50Hz - 20KHz	40Hz - 20KHz	40Hz - 20KHz	55Hz - 20KHz	60Hz - 20KHz
Shipping	Pair	Single	Single	Pair	Single	Pair	Single

## SERIES SIX

**Impedance**  
8 Ohms

**Sensitivity**  
89dB

**Power**  
100w RMS / 200w Peak

**Woofer Material**  
Kevlar® / Carbon  
Fiber Weave

**Tweeter Material**  
Titanium



NV-61C6



NV-61C6-ANG



NV-61C8



NV-61C8-ANG



NV-61W6



NV-61W6-LCR

Overall Dimensions	9.06" / 230mm	9.06" / 230mm	10.63" / 270mm	11.22" / 285mm	8.66" x 11.81" / 220mm x 300mm	8.66" x 17.71" / 220mm x 450mm
Cutout Dimensions	8.07" / 205mm	8.07" / 205mm	9.68" / 246mm	10.15" / 258mm	7.6" x 10.79" / 194mm x 274mm	7.6" x 16.65" / 193mm x 423mm
Woofer Size	6.5"	6.5"	8"	8"	6.5"	6.5"
Tweeter Size	1"	1"	1"	1"	1"	1"
Mounting Depth	3.94" / 100mm	4.76" / 121mm	4.41" / 112mm	5.55" / 141mm	3.27" / 83mm	3.5" / 90mm
Frequency Response	60Hz - 20KHz	60Hz - 20KHz	35Hz - 20KHz	35Hz - 20KHz	50Hz - 20KHz	45Hz - 20KHz
Shipping	Pair	Single	Pair	Single	Pair	Single

# OUTDOOR SPEAKERS

## SERIES TWO

**Impedance**  
8 Ohms

**Sensitivity**  
87dB

**Power**  
50w RMS / 100w Peak

**Woofer Material**  
Poly

**Tweeter Material**  
UFLC



NV-20D5-XX

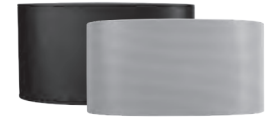

NV-20D6-XX

COLOR KEY: WH BK Replace XX with the appropriate color code for part number.

## SERIES SIX

**Impedance**  
8 Ohms

**Sensitivity**  
88dB

**Power**  
60w RMS / 120w Peak

**Woofer Material**  
Kevlar® / Carbon  
Fiber Weave

**Tweeter Material**  
Titanium



NV-60D5-XX



NV-60D6-XX



NV-60D5=DVC-XX



NV-60D6=DVC-XX

COLOR KEY: WH BK Replace XX with the appropriate color code for part number.

## SERIES TWO LANDSCAPE

**Impedance**  
8 Ohms

**Sensitivity**  
86dB

**Power**  
280w

**Woofer Material**  
Poly

**Tweeter Material**  
UFLC



NV-2LSK-BK  
Subwoofer + 4 Satellites

NV-2LS3-SAT2  
Two Satellites



# Nuvo®



3015 Kustom Drive  
Hebron, KY 41048  
United States  
844.334.8044  
[www.legrand.us/nuvo](http://www.legrand.us/nuvo)