



**NDS**<sup>®</sup>  
We put water in its place

Your knowledgeable and  
trusted partner for the best in  
water management solutions



## 2016/2017 Product Catalog

Commercial Stormwater Management

Residential Stormwater Management

Professional Irrigation

Flow Management

[ndspro.com](http://ndspro.com)

MADE IN  
**USA**



# DRAINAGE

From your backyard patio to the neighborhood aquatic center, from the factory floor to a professional sports facility, NDS offers the right drainage solutions.

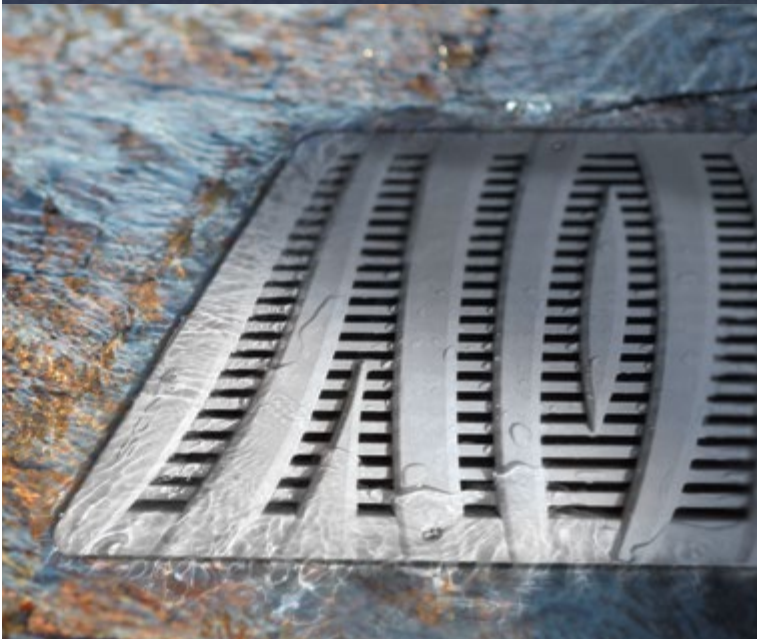





## SUSTAINABLE STORMWATER SOLUTIONS

S5 by NDS™ offers a comprehensive solution in line with Low Impact Development policies by managing stormwater as close to its source as possible through runoff reduction and quality enhancement at the site scale. The S5 system is built around known and trusted components, providing solutions that offer 5 key benefits:

- Conservation of water resources to improve our well-being
- Management of stormwater at the source to reduce downstream impact
- Flexibility of system footprint allows for adaptive implementation
- Mitigation of pollution and erosion to protect water systems
- Replenishment of groundwater to help ensure future supply

A single-source solution, S5 by NDS is easy to specify, qualifies for LEED credits and offers up to 250% more detention volume than traditional gravel systems.

# Design Your S5 System

An effective onsite stormwater system can be designed in 5 easy steps:

- 1 Identify Sources** - Stormwater runoff may come from point sources like downspouts, as sheet flow from parking lots, irregularly through drainage ways in the landscape, or even as elevated groundwater.
- 2 Select Method of Capture** - Each runoff source has a practical method of capture for conveyance to the detention and infiltration area.
- 3 Determine Peak Flow and Detention Volume** - The quantity of runoff for a given rainfall event over a defined area is easily calculated when surface type and rainfall intensity are known by using the Rational Method formula  $Q = CiA$ . Applicable regulations generally provide guidance on the rainfall intensity to use for a given set of circumstances.
- 4 Size the System** - Detention and infiltration devices have measured holding capacities. Select the appropriate quantity and arrangement of devices to handle the predetermined runoff volume calculated above. Also consider the capacity of conveyance and overflow piping.
- 5 Determine Field Layout** - Site constraints including setbacks, landform, soil types, fixed objects and open space, among others, will inform the location and arrangement of system components. Each element of runoff capture, filtration, conveyance, detention, infiltration and overflow must be considered.

## CAPTURE

**Catch basins** receive runoff from downspout and landscaped areas. **Channel drains** accept sheet flows from paved walks and parking.

## FILTRATION

**Basins and channel grates** provide a front line of debris filtration; adding fabric **filters** contributes further removal of fines from stormwater, extending system life. **Chamber systems** have advanced filtration options.

## CONVEYANCE

Smooth-wall and corrugated pipe with compatible fittings and adapters convey stormwater from the point of capture to the detention and infiltration area. Select pipe type and set pipe slope to handle the anticipated runoff volumes based on established pipe-flow characteristics. Using EZflow for conveyance may reduce the footprint of downstream detention and infiltration areas.

## DETENTION & INFILTRATION

**Flo-Well**® manufactured dry wells provide 50 gallons of detention volume. Each unit has multiple connection points including sidewall and top-cover knock outs to receive 3" to 8" pipe. Flo-Well's are stackable and can be arranged in multiple configurations.

**Triton™ Stormwater Chambers** provide a lower cost alternative to drainage pipes for conveyance, with added benefits of groundwater recharge and water quality enhancement. Offering up to 46% greater capacity than competitive products, chamber storage is equivalent to a 43" diameter pipe. Chambers eliminate the need for restrictive holding ponds and can be double-stacked in many applications to reduce footprint and save valuable land space.

**EZflow**® engineered French drains are 10' bundles of Poly-Rock aggregate with or without corrugated drain pipe. Bundles are available in 7", 10" and 15" diameters, with or without 3", 4" or 6" pipe, respectively. A standard infiltration trench consists of a 10" bundle with 4" pipe atop two 15" aggregate-only bundles, providing over 100 gallons of detention volume.

## OVERFLOW

**Pop-up emitters** allow excess runoff beyond system capacity to discharge in a safe location.

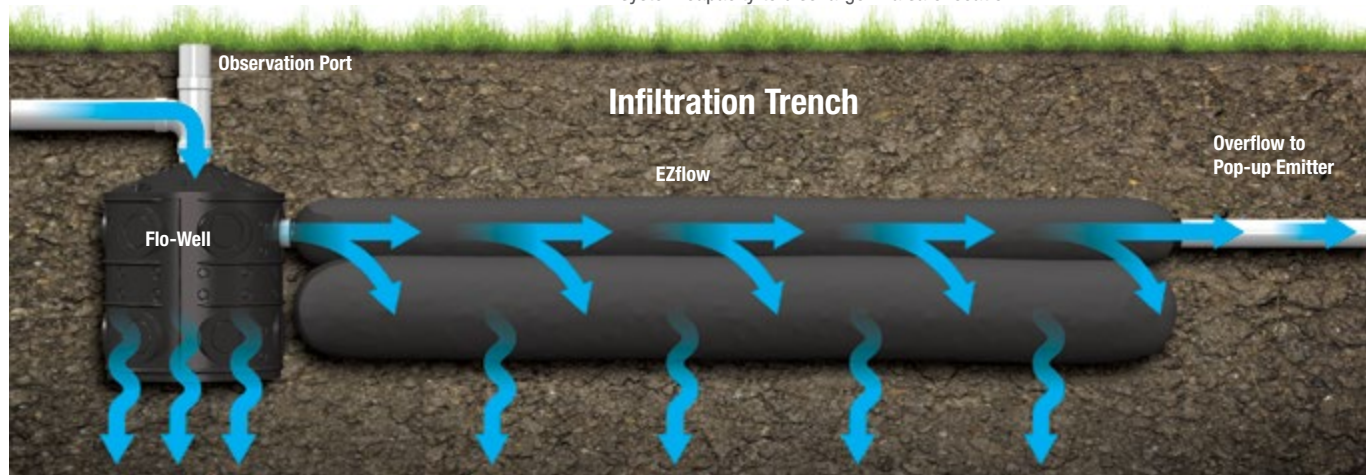
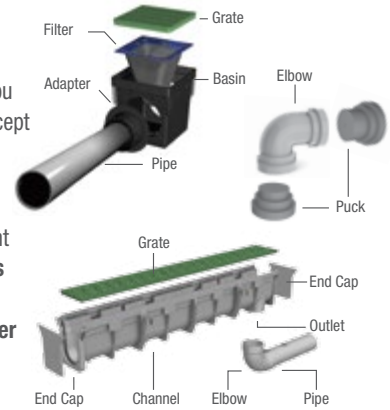

DRAINAGE



# SUSTAINABLE STORMWATER SOLUTIONS

**NDS S5 components can be configured to meet a wide variety of residential and commercial applications.**

## CAPTURE

S5 offers several options to collect stormwater from various sources.

- Catch basins function effectively as area drains and for downspouts from roofs
- Channel drains intercept sheet flow from paved surfaces
- Permeable grass and gravel paver systems with underdrains collect stormwater from walkways and parking areas when used as alternatives to traditional impermeable solutions

## FILTER

Prevent debris and other suspended solids in stormwater from impairing system function.

- Basin and channel grates provide a front line of mechanical filtration
- Fabric filters contribute further removal of fines from stormwater, extending system life
- Grass and gravel paver systems naturally filter and clean stormwater while flowing through the S5 permeable paver solutions
- Triton™ Stormwater Chambers eliminate the need for costly pre-treatment devices and provide an alternative to drain pipe that offers groundwater recharge and water quality enhancement

## CONVEY

Move stormwater from its sources to downstream detention, infiltration and overflow components.

- Smooth-wall and corrugated pipe with appropriate fittings and adapters have known flow characteristics to get the job done
- Using EZflow® for conveyance will also increase system detention and infiltration, effectively reducing the footprint of the downstream detention area

## DETAIN

S5 detention components provide efficient volume to minimize runoff and maximize infiltration.

- Flo-Well® dry wells and EZflow® infiltration-trench arrangements have defined volumes for this purpose
- Flo-Well® has 250% more detention volume than traditional stone-filled dry wells
- Triton™ Stormwater Chambers offer unique underground capacity that is up to 46% greater than competitive products

## INFILTRATE

Arrange Flo-Well® dry wells, Triton™ Stormwater Chambers and EZflow® infiltration trenches in customizable configurations and at depths suitable to existing site conditions, soil types and groundwater elevations.

- Flo-Well® has an open bottom and side knockouts to allow direct infiltration, and EZflow® maximizes soil-contact area for effective infiltration
- Triton™ Stormwater Chambers eliminate the need for restrictive holding ponds, allowing for more buildable area and green space opportunities

## OVERFLOW

Allow for excess stormwater beyond the design storm to overflow from the system in a safe, suitable downstream location.

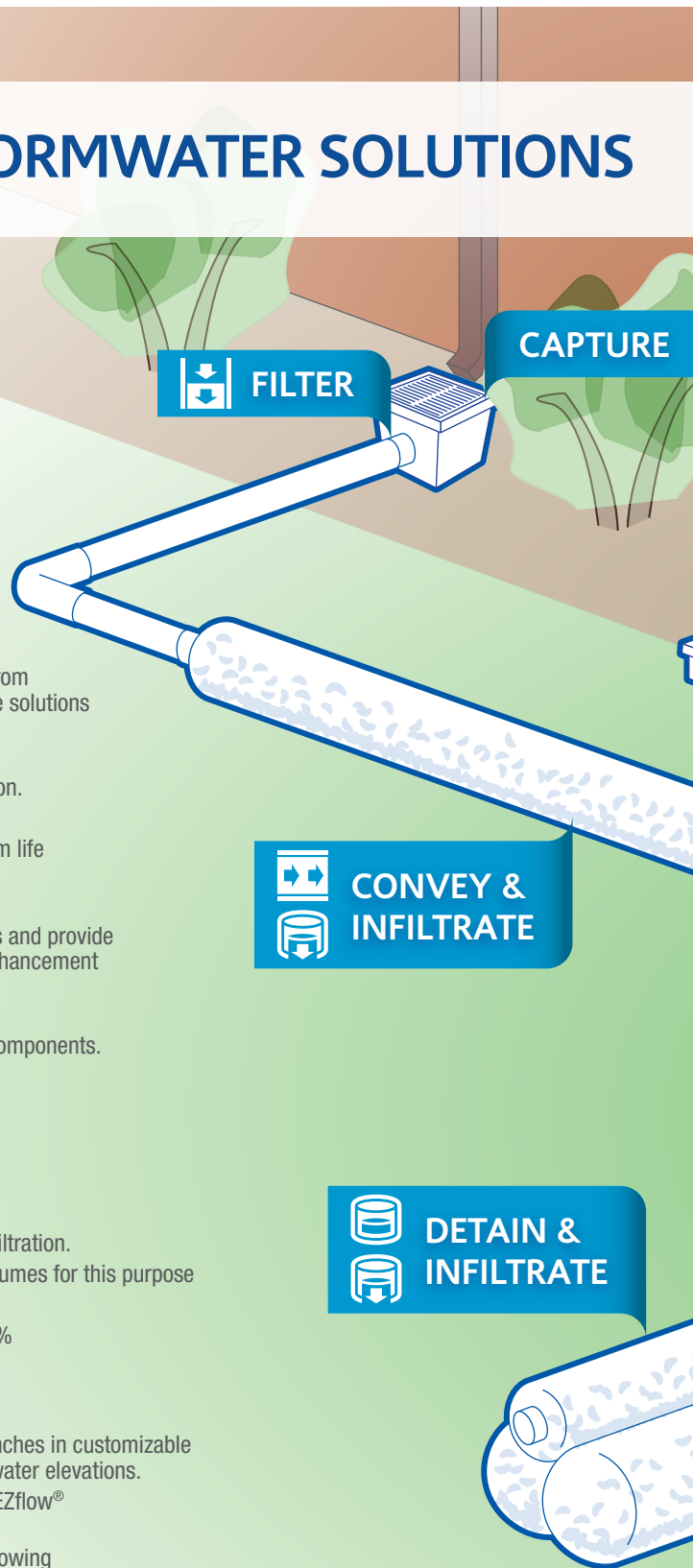

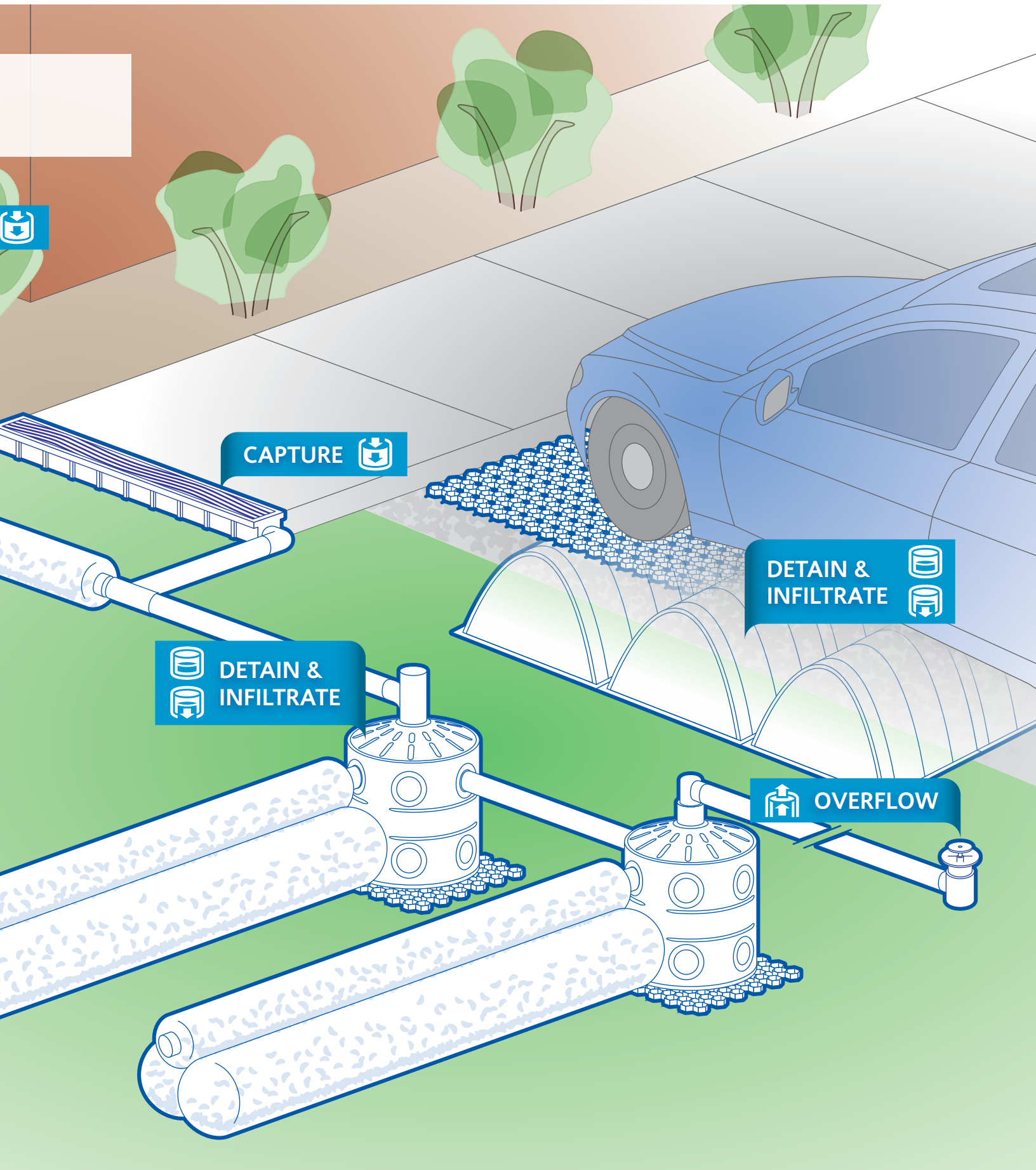

# SUBSURFACE DRAINAGE & INFILTRATION



EZflow®  
Foundation  
Drainage



Landscape



Retaining Walls

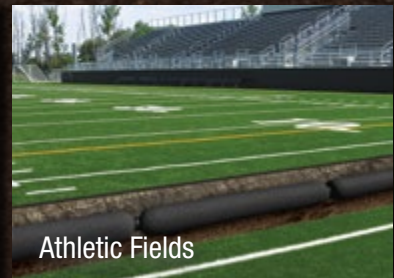

Athletic Fields



## THE NDS SOLUTION

Whether you need a dry well, French drain or infiltration trench, NDS has you covered with innovative and proven subsurface drainage and stormwater infiltration products. EZflow® French drain system, Triton™ Stormwater Chambers and Flo-Well® dry well provide trusted performance for multiple applications and are lightweight and easy to install. These engineered solutions are proven time-and-labor savers that outperform traditional systems in flow through and storage capacity. When performance and sustainability matter, NDS solutions are the preferred choice of contractors, engineers and landscape architects. **EZflow®, Triton™ Stormwater Chambers and Flo-Well® are made in the USA and each contribute to project LEED credits when used as part of the stormwater management design and by contributing to the proportion of recycled materials.**



### EZflow®

**EZflow® offers an engineered and gravel-free alternative to a traditional French Drain system.** EZflow® can be used to lower subsurface groundwater elevations; protecting property and improving the health of playing fields and planted areas. It can also be used as an infiltration trench for managing stormwater runoff. Available in multiple diameters with or without pipe, this versatile product is an effective component of subsurface drainage and infiltration systems.

- Installs in half the time of traditional gravel systems
- Better flow capacity than traditional stone-and-pipe systems
- Up to H-10 load rating with 12" of compacted soil cover
- Over 100 million linear feet installed



### Triton™ Stormwater Chambers

**Stormwater Chambers provide a lower cost alternative to drainage pipes for conveyance, with added benefits of groundwater recharge and water quality enhancement.** Significantly lighter, larger and stronger than conventional chambers, Triton™ Stormwater Chambers are the ideal solution for stormwater detention and/or infiltration, providing easy installation and greater design flexibility to meet target stormwater runoff rates, volume control, and water quality requirements.

- Eliminates the need for costly pre-treatment devices
- Eco-friendly soy-oil based and carbon-neutral product
- Eliminates the need for restrictive holding ponds and creates new opportunities for green space with unique underground capacity
- Achieves up to 18 LEED credits and Zero Discharge goals



### Flo-Well®

**Flo-Well® engineered dry well presents an easy to install and sustainable solution for managing stormwater runoff.** Flo-Well® is a gravel-free alternative to a traditional dry well with up to 250% more detention volume. Used independently or as part of a larger system, Flo-Well® units collect and detain stormwater allowing for groundwater recharge. Units are modular and can be connected in series or stacked to meet a variety of project needs.

- Up to 50 gallons of detention volume per unit
- Connect units in series for larger volumes or stack for reduced footprint
- Fast and easy installation with no heavy equipment or gravel needed
- Manufactured from 100% recycled materials

## EZFLOW®: A BETTER FRENCH DRAIN



Gravel-free installation provides up to 50% labor savings over traditional systems

Better flow through and detention volume than traditional systems

Durable with a 100-year lifespan

Projects qualify for LEED credits

EZflow is a key component in the NDS S5 system

DRAINAGE

### EZflow® Drainage Bundles

EZflow® drainage bundles are 10 feet in length with a slotted pipe surrounded by expanded polystyrene aggregate and enclosed in geotextile mesh. Configurations are available in 7-inch bundles with or without a 3-inch pipe, 10-inch bundles with or without a 4-inch pipe, and 15-inch bundles with or without a 6-inch pipe. Accessories include 3-inch, 4-inch, and 6-inch internal couplers and end caps. EZflow® bundles can also be used with internal tees, and internal wyes. The 15-inch bundles are available with the pipe located in the center or bottom of the bundle for varying applications. Unless specifically required by code or other requirement, the pipe can be either centered or at the bottom of the bundle.

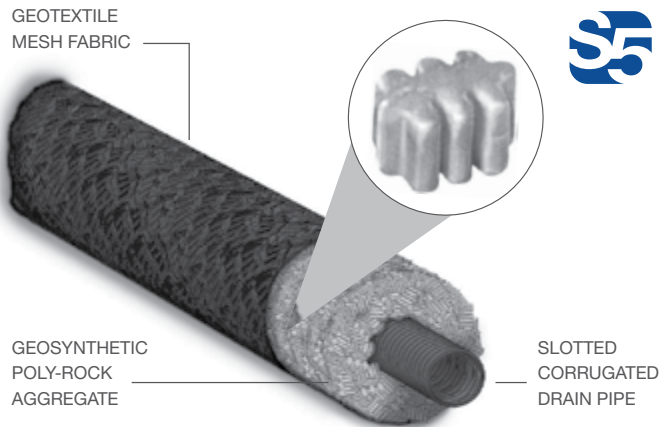

### Applications

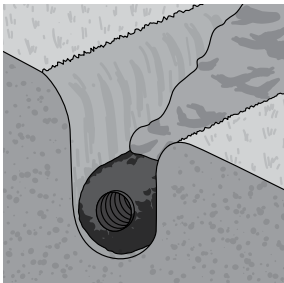

French/Interceptor Drains

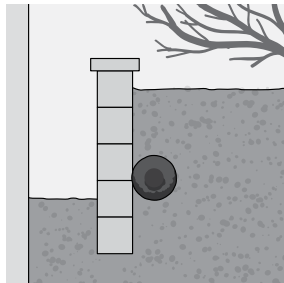

Planter/Retaining Walls

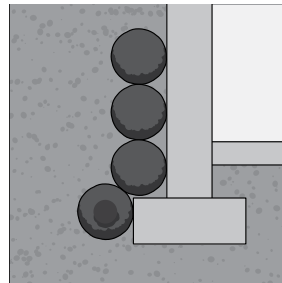

Foundation Drains

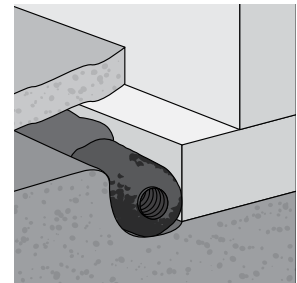

Basement/Crawlspace

EZflow® drainage systems are appropriate for a wide range of applications and are a convenient alternative to traditional stone and pipe drainage, storage and infiltration systems. EZflow® drainage systems can be used as a substitute for stone in most applications where the stone is not utilized for structural support. A professional engineer, landscape architect or other qualified design professional should be consulted for complex applications.

Product selection is relative to the desired application and benefits from establishing anticipated flow into, through and out of a proposed drainage system configuration. Selection considerations include: bundle sizing and storage volume, the presence or absence of pipe, pipe size and location within the bundle, and arrangement of bundles. Design factors may include: length of system, watershed area, soil type and permeability, groundwater levels and system discharge opportunities. EZflow® drainage storage volumes and pipe discharge rates are listed on the next page.

## EZFLOW® ENGINEERED FRENCH DRAIN

### EZflow® Gravel-Free French Drain

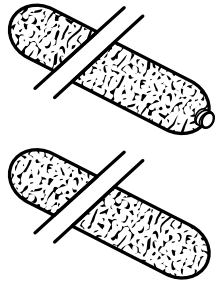

Part No.	Description	Color	Bundle size/ Linear Feet	Wt. per Bundle (lbs.)	Product Class	Specifications
EZ-0701F	7" mesh with 3" slotted pipe (center)	Black	90	32.4	11RP	10 ft. polyethylene slotted drain pipe surrounded by 100% recycled polystyrene aggregate and enclosed in 30-sieve polyethylene geotextile mesh.
EZ-1001F	10" mesh with 4" slotted pipe (center)	Black	50	29.5	11RP	
EZ-1501F	15" mesh with 6" slotted pipe (center)	Black	20	26.0	11RP	
EZ-1501FB	15" mesh with 6" slotted pipe (bottom)	Black	20	26.0	11RP	
EZ-0701A	7" mesh without pipe – aggregate only	Black	90	18.0	11RP	10 ft. segment of 100% recycled polystyrene aggregate only, enclosed in 30-sieve polyethylene geotextile mesh.
EZ-1001A	10" mesh without pipe – aggregate only	Black	50	13.5	11RP	
EZ-1501A	15" mesh without pipe – aggregate only	Black	20	12.4	11RP	

DRAINAGE

### EZflow® Internal Couplings & End Caps

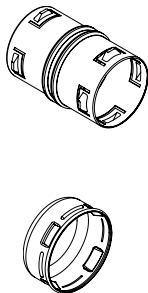

Part No.	Description	Color	Pkg. Qty.	Wt. Ea. (lbs.)	Product Class
3C05	3" Corrugated Internal Coupling	Black	60/box	0.30	11RP
4C07	4" Corrugated Internal Coupling	Black	36/box	0.30	11RP
6C07	6" Corrugated Internal Coupling	Black	12/box	0.80	11RP
3C06	3" Corrugated End Cap	Black	33/box	0.30	11RP
4C06	4" Corrugated End Cap	Black	21/box	0.50	11RP
6C06	6" Corrugated End Cap	Black	15/box	0.50	11RP

### Storage & Flow for EZflow® Drainage Bundles *(45% void space among consolidated EPS aggregate)*

Pipe Bundles						
Product	Storage Volume (gallons/10 ft. bundle)	Flow Capacity (gpm @ 1% slope)	EZ-0701F	EZ-1001F	EZ-1501FB	EZ-1501
EZ-0701F	11.4	80.8	7"	10"	15"	15"
EZ-101F	21.5	130.9	3" PIPE (CENTERED)	4" PIPE (CENTERED)	6" PIPE (BOTTOM)	6" PIPE (CENTERED)
EZ-1501F/EZ-1501FB	45.8	345.0				
Aggregate-Only Bundles						
Product	Storage Volume (gallons/10 ft. bundle)	Flow Capacity (gpm @ 1% slope)	EZ-0701A	EZ-1001A	EZ-1501A	
EZ-0701A	8.8	37.1	7"	10"	15"	
EZ-1001A	17.2	75.7	NO PIPE	NO PIPE	NO PIPE	
EZ-1501A	36.5	170.3				

# TRITON™ STORMWATER CHAMBERS: A BETTER STORMWATER SOLUTION

DRAINAGE



Triton™ Stormwater Chambers are subsurface structures that are used to collect, retain and discharge stormwater on commercial and residential sites. They provide a lower cost alternative to drainage pipes for conveyance, with added benefits of groundwater recharge and water quality enhancement.

## Modular, High Volume Stormwater Retention

Triton™ chambers are made of an industry leading soy-based resin that makes them both stronger and lighter than any other product on the market. Modular units feature an interlocking corrugated joint system that allows them to be securely connected and arranged in a diverse array of configurations. The strength of each unit also allows two layers of chambers to be stacked vertically to accommodate a large amount of water storage while minimizing installation footprint. NDS offers three sizes of chambers to provide the appropriate size solution for any project.



### Key Benefits:



#### Lighter

- 46% lighter per cubic foot of storage than competitive products, making it easy to transport

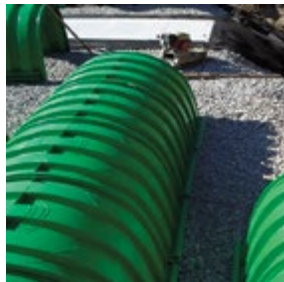

#### Larger

- Up to 46% greater capacity per linear foot than the competition, equivalent to a 43" diameter pipe



#### Stronger

- Exceeds the latest AASHTO LFRD Bridge Design Spec 1
- Tests validate chambers withstand a rear axle load of 48kips without a pavement layer



#### Compatible

- Modular system can be designed to fit any commercial or residential site



#### Greener

- Eco-friendly soy-oil based and carbon-neutral product
- Achieves up to 18 LEED credits and Zero Discharge goals



#### Cost Effective

- Stacks for shipment on standard pallets, reducing shipping cost
- Faster installation means a reduction in labor costs

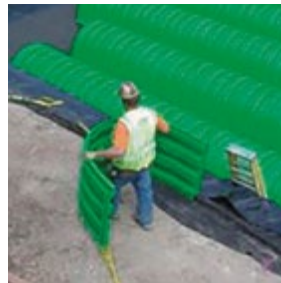

#### Easier to Install

- One person installation with engineered connections for fast, easy installation



#### Double Stack Installation

- Can be installed double stacked without voiding the warranty

# TRITON™ STORMWATER CHAMBERS

## Triton™ Stormwater Chambers

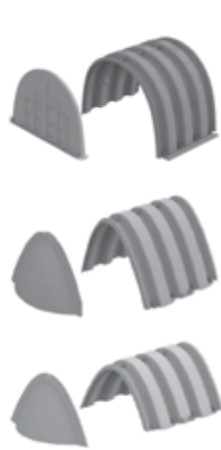

Part No.	Description	Pallet with Product Dimensions	Color	Parts per Pallet	Parts per Truckload	Weight per Pallet (lbs.)	Pallets per 53' Van	Product Class
S29-CH	Chamber 36 Tall	60" W x 36" L x 101" H	Green	23	621	812	27	10TC
S29-EC	End Cap 36 Tall	60" W x 36" L x 45" H	Green	10	270	190	27	10TC
C10-CH	Chamber 25 Tall	40" W x 32" L x 88" H	Green	40	1680	710	42	10TC
C10-EC	End Cap 25 Tall	40" W x 32" L x 32" H	Green	35	1470	280	42	10TC
M6-CH	Chamber 17 Tall	40" W x 32" L x 88" H	Green	40	1680	550	42	10TC
M6-EC	End Cap 17 Tall	40" W x 32" L x 25" H	Green	35	1470	201	42	10TC
MHR-ELB	Filter Elbow	60" W x 36" L x 45" H	Gray	30	30	280	30	10TC
S29-FL	Sediment Floor	60" W x 42" L x 45" H	N/A	50	50	950	50	10TC
SSFP-SH	Stainless Steel Filter Puck-Shallow	60" W x 36" L x 45" H	N/A	36	36	161	36	10TC
SSFP-DP	Stainless Steel Filter Puck-Deep	60" W x 36" L x 45" H	N/A	36	36	186	36	10TC

DRAINAGE

## Main Header Row System

### Innovative Design

- Ideal method for removing suspended solids
- Easily adaptable to a variety of site requirements

### Simple to Install

- Comprised of several chambers that sit on interconnecting sediment floor sections
- The interlocking design allows for quick connection of chambers

### Simple to Maintain

- Manholes in the sump basin and on the Main Header Row itself give maintenance personnel simple access points to inspect the system



# FLO-WELL®: A BETTER DRY WELL

DRAINAGE



With the Flo-Well®, water can now be discharged into the subsoil rapidly and easily. Unlike competitive systems, there is no need for piping systems to transport stormwater to a far-off discharge point, large heavy equipment, considerable excavation of current landscaped areas, nor large labor costs that those systems incur. With Flo-Well, water dispersion is now easier than ever. Flo-Well is a key component in the NDS S5 System.

## Options

Larger 9" or 12" grates can be added to Flo-Well to manage surface water.	Ideal as a stand-alone drain:	Ideal as a stand-alone reservoir:
<p><b>This option is ideal for draining:</b></p> <ul style="list-style-type: none"> <li>Golf course areas prone to puddling</li> <li>Playground areas under slides and swings</li> <li>Outdoor drinking fountain runoff</li> <li>Outdoor showers at beaches</li> <li>Wash-down areas</li> </ul>	<ul style="list-style-type: none"> <li>Disturbs only 4 square feet of turf to install</li> <li>Requires less than 10 cubic feet of soil removed to bury</li> <li>Measures only 24" in diameter by 28.75" high</li> <li>Weighs only 22 pounds</li> <li>Holds over 48 gallons. Or, connect to existing system for increased drainage capabilities</li> </ul>	<ul style="list-style-type: none"> <li>Collect and hold rainwater for lawn and garden irrigation (used with a pump connected to a garden hose)</li> <li>Connect Flo-Well to rain gutters using a catch basin &amp; grate below each downspout (see drawing)</li> <li>Ideal solution for arid areas impacted by drought</li> <li>Reservoir for pond and waterfall recirculation pumps</li> </ul>



## Stackable & Expandable

Flo-Well® can be used individually, connected in series or in any array, and can be stacked up to 4 units high (with center support pipe).

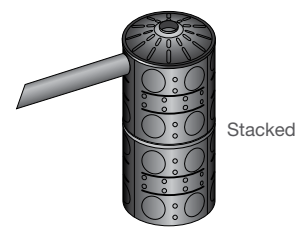
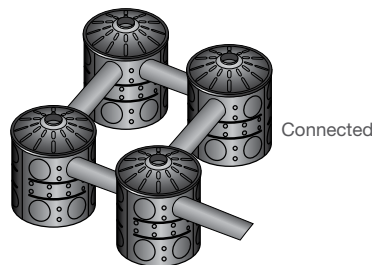

## Applications

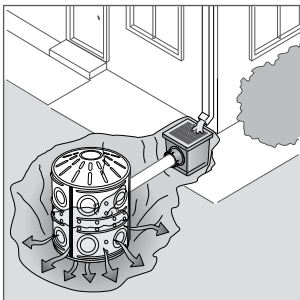

For gutters and downspouts

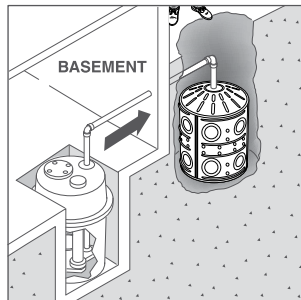

Install with sump pumps

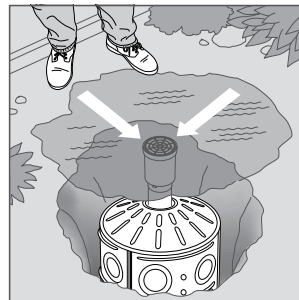

Eliminates puddles

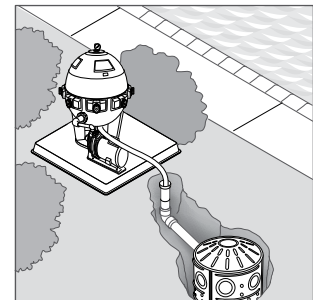

Backwash tank

# FLO-WELL® ENGINEERED DRY WELL

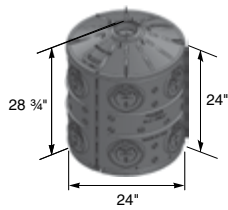

Part No.	Description	Color	Pkg. Qty.	Wt. Ea. (lbs.)	Product Class	Specifications
FWAS24WH	24" diam. x 28.75"H Flo-Well® Stormwater Leaching System	Black	1	18.96	10FW	NDS #FWAS24WH structural foam polyolefin round drywell system with UV inhibitors. 50 gal. storage capacity.
Includes 3 side panels, 1 top component. Fits 4" Sch. 40 Pipe and 4" DWV Pipe.						

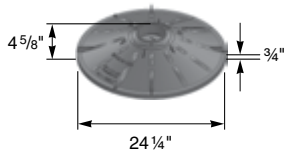

Part No.	Description	Color	Pkg. Qty.	Wt. Ea. (lbs.)	Product Class	Specifications
FWAS24CWH	24" diam. Flo-Well® Cover	Black	2	5.92	10FW	Structural foam polyolefin round drywell system cover with UV inhibitors. 24 1/4" dia., 4 5/8" height, 3/4" outer lip, 4.5" center knockout fits NDS #FWSD69, std pipe and 4" Sch. 40 pipe.
Use with #FWAS24.						

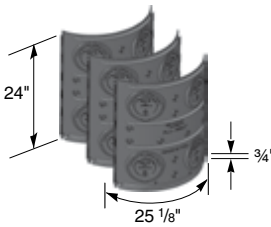

Part No.	Description	Color	Pkg. Qty.	Wt. Ea. (lbs.)	Product Class	Specifications
FWSPS3WH	Flo-Well® Side Panels/Extension Only	Black	1	4.35	10FW	Structural foam polyolefin side panels with UV inhibitors with 22 1-1/2" knockout leaching ports and 4 4.5" knockout inlet/outlet ports per panel. 0.75" lip for firm stacking.
Includes 3 side panels; makes 1 round drywell. (May also be used as a durable compost bin)						

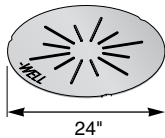

Part No.	Description	Color	Pkg. Qty.	Wt. Ea. (lbs.)	Product Class	Specifications
FWBP24	24" diam. Flo-Well® Bottom	Black	5	3.41	10FW	Structural foam polyolefin round Flo-Well® bottom with UV inhibitors. 24" diameter with six 1-1/2" leaching ports. Collects debris for easy cleanout.
Fits #FWAS24. (Not included in #FWAS24 kit)						

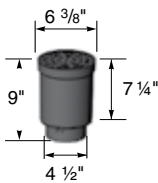

Part No.	Description	Color	Pkg. Qty.	Wt. Ea. (lbs.)	Product Class	Specifications
FWSD69	4" Sch. 40 Surface Drain Inlet with Grate	Black	8	1.85	10FW	Structural foam polyolefin 6" grate with 4" inlet with UV inhibitors. 6" diameter at inlet. 9" high. 4.5" OD fits Sch. 40 PVC fittings. Open surface area 8.22 square inches. 25.15 GPM.
Fits #FWAS24 and #FWAS24C. ADA Compliant.						

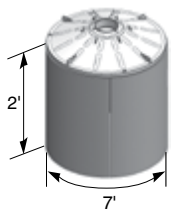

Part No.	Description	Color	Pkg. Qty.	Wt. Ea. (lbs.)	Product Class	Specifications
FWFF67	Porous Filter Fabric Wrap for Flo-Well®	Black	1	0.35	10FW	7" long x 2" wide to surround Flo-Well® Drywell System. Non-woven fabric. Weight 1 oz. Mullen burst 175 psi. 200 GPM flow-through.
Use with #FWAS24.						

# CATCH BASINS

DRAINAGE



NDS catch basins and grates collect surface water while minimizing the amount of debris entering the system

Available in a range of sizes from 6" round to 24" square, and with various grating and filter options for commercial and residential systems.

## NDS Drainage Solutions

NDS offers a complete line of catch basins and grates for residential and commercial stormwater management solutions. NDS catch basins have sump areas that collect debris and prevent clogging of the pipeline, and grates are available in a variety of patterns and colors to blend in with surrounding surfaces. Depending on the size of the round, square, or atrium grates, they may fit directly into a riser of pipe, sewer and drain fitting, or our catch basins.



Small Grates

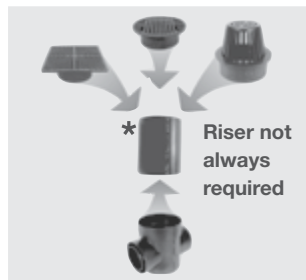

Spee-D® Basin  
\* Shown with section of 6" S&D pipe (Not NDS product).

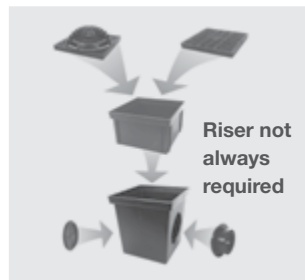

Large Catch Basin

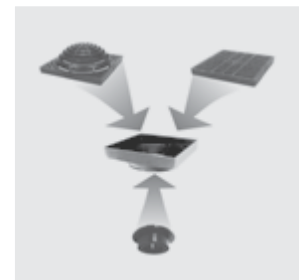

Adapter

## Spee-D® Basins

Use our compact 6" round Spee-D Basins with grates to collect runoff water while its sump area collects debris and prevents clogging. Also use Spee-D Basins with 6" Pop-Up Emitters to provide a point of discharge or overflow in a drainage system.

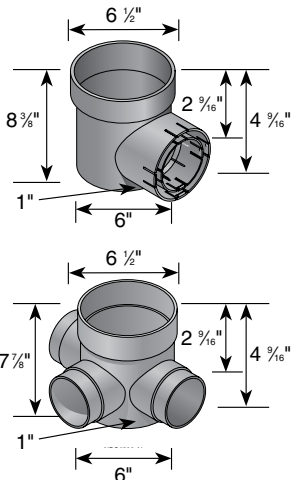

Part No.	Description	Color	Pkg. Qty.	Wt. Ea. (lbs.)	Product Class	Specifications
101	1 - 3" and 4" Locking Outlet*	Black	10	1.60	10ND	6" styrene catch basin with locking outlet. 68 GPM per outlet capacity.
201	3" and 4" Locking Outlets*	Black	10	1.83	10ND	

Fit 3" or 4" Sewer & Drain Pipe, 3" or 4" Corrugated Pipe, 4" Sch. 40 and 3" & 4" Triple Wall Pipe. Use 6" Sewer and Drain Pipe as a riser for all 6" round catch basins. Use waterproof silicone to make water-tight connections.  
\* New Locking Outlet snaps on to most 3" and 4" corrugated pipe.

Part No.	Description	Color	Pkg. Qty.	Wt. Ea. (lbs.)	Product Class	Specifications
250	2 - 3" and 4" 90° Outlets	Black	12	1.64	10ND	6" styrene catch basin with locking outlet. 83 GPM per outlet capacity.
300	3 - 3" and 4" Outlets	Black	12	1.82	10ND	
350	3" and 4" Outlets	Black	12	2.00	10ND	

Fit 3" or 4" Sewer & Drain Pipe, 3" or 4" Corrugated Pipe, 4" Sch. 40 and 3" & 4" Triple Wall Pipe. Use 6" Sewer and Drain Pipe as a riser for all 6" round catch basins. Use waterproof silicone to make water-tight connections.



# CATCH BASINS

## 9" Catch Basin Series



DRAINAGE



Part No.	Description	Color	Pkg. Qty.	Wt. Ea. (lbs.)	Product Class	Specifications
900FF	9" Catch Basin Filter	Blue Frame/Black Bag	8	0.06	10ND	Polypropylene Frame Fabric is non-woven geotextile 956 PM/SF.
Compatible with these basins: 900, 900-4 and 916 NDS Catch Basins, Risers and Kits						

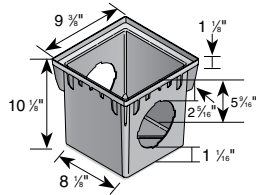

Part No.	Description	Color	Pkg. Qty.	Wt. Ea. (lbs.)	Product Class	Specifications
900BLKIT	9" x 9" Catch Basin Kit	Black Grate	4	4.90	10ND	9" x 9" tapered Catch Basin. Polypropylene.
900GRKIT	9" x 9" Catch Basin Kit	Green Grate	4	4.90	10ND	
900KITDISP	9" x 9" Catch Basin Kit	Black Grate	8	39.2	10ND	Kits include 2-opening Catch Basin, Grate, Screws, 2 Outlets and 1 Plug.
900	9" x 9" Catch Basin 2-opening	Black	4	2.18	10ND	
900-4	9" x 9" Catch Basin 4-opening	Black	4	2.00	10ND	
Requires either #1206, #1242, #1243, #1245 or #1266 Universal Outlet to connect pipe to basin. (see pages 32-33)						DISP includes display box.

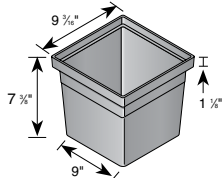

Part No.	Description	Color	Pkg. Qty.	Wt. Ea. (lbs.)	Product Class	Specifications
916	9" x 9" Catch Basin Riser	Black	4	1.75	10ND	6" Riser for 9" x 9" Catch Basin. Styrene.
Use with 9" x 9" Catch Basin Series. Stacks on top of 9" catch basins to add up to 6" to top of basin. Can be cut to size.						

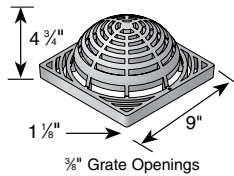

Part No.	Description	Color	Pkg. Qty.	Wt. Ea. (lbs.)	Product Class	Specifications
981	9" x 9" Atrium Grate	Black	6	0.87	10ND	9" Structural Foam Polyolefin Dome Atrium Grate with UV inhibitor.
991	9" x 9" Atrium Grate	Green	6	0.87	10ND	Open surface area 31.50 square inches. 96.36 GPM.
Use with 9" x 9" Catch Basin Series.						

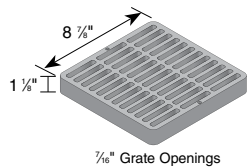

Part No.	Description	Color	Pkg. Qty.	Wt. Ea. (lbs.)	Product Class	Specifications
980	9" Square Grate	Black	8	1.50	10ND	9" Square Structural Foam Polyolefin Grate with UV inhibitor. Open surface area 37.49 square inches. 114.69 GPM.
990	9" Square Grate	Green	8	1.50	10ND	
999	9" Square Grate	Gray	8	1.50	10ND	
999S	9" Square Grate	Sand	8	1.50	10ND	
Use with 9" x 9" Catch Basin Series. NDS #980, 990, 999, 999S: Class A Load Rated. ADA Compliant. NDS #930B: Class B Load Rated. (see page 74). ADA Compliant.						

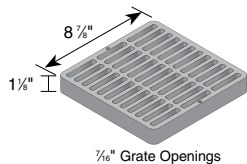

Part No.	Description	Color	Pkg. Qty.	Wt. Ea. (lbs.)	Product Class	Specifications
930B	9" Square Brass Grate	Brass	1	5.11	15BR	Open surface area 34.00 square inches. 104.01 GPM. Includes SS Screws.
(see page 74). ADA Compliant.						

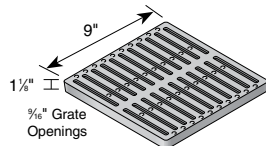

Part No.	Description	Color	Pkg. Qty.	Wt. Ea. (lbs.)	Product Class	Specifications
913	9" Square Ductile Iron Grate	Black	4	7.89	10ND	9" Square Heavy-Duty Ductile Iron Grate. Open surface area 21.70 square inches. 66.38 GPM.
Use with 9" x 9" Catch Basin Series. (see page 74)						

## CATCH BASINS

### 9" Catch Basin Series (continued)

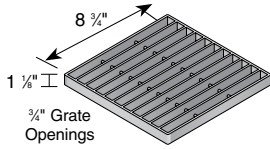

Part No.	Description	Color	Pkg. Qty.	Wt. Ea. (lbs.)	Product Class	Specifications
915	9" Square Galvanized Steel Grate	Galvanized Steel	4	3.80	10ND	9" Square Heavy-Duty Galvanized Steel Bar Grate. Open surface area 61.94 square inches. 189.48 GPM.
	Use with 9" x 9" Catch Basin Series. (see page 74)					

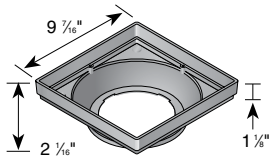

Part No.	Description	Color	Pkg. Qty.	Wt. Ea. (lbs.)	Product Class	Specifications
930	9" x 9" Low-Profile Adapter	Black	8	0.75	10ND	9" x 9" Low-Profile Adapter. Styrene.
	Requires NDS #1243, #1245, #1266 or #1889 Universal Outlets to connect pipes.					

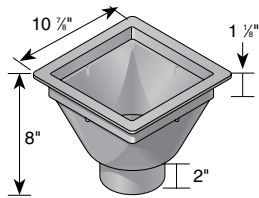

Part No.	Description	Color	Pkg. Qty.	Wt. Ea. (lbs.)	Product Class	Specifications
931	9" x 9" Deep Housing Spigot Adapter	Black	10	2.40	10ND	9" x 9" Square Deep Housing Spigot Adapter. Styrene.
	Fits 4" Corrugated Pipe. Use #933 to adapt to 4" Sewer and Drain Pipe.					

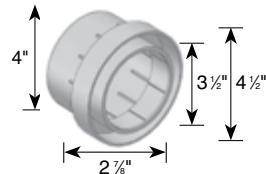

Part No.	Description	Color	Pkg. Qty.	Wt. Ea. (lbs.)	Product Class	Specifications
933	Adapter Bushing	Black	20	0.30	10ND	Styrene.
	Fits 4" Sewer and Drain Pipe. Use Housing Adapter Bushing with #931.					

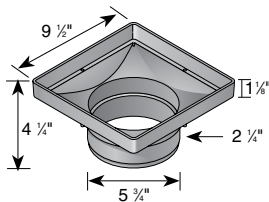

Part No.	Description	Color	Pkg. Qty.	Wt. Ea. (lbs.)	Product Class	Specifications
932	9" x 9" Low-Profile Housing Adapter	Black	8	1.13	10ND	NDS #932, 9" x 9" Square Low-Profile Housing Adapter with 6" Outlet. Styrene.
	Fits 6" Spee-D® Basin and 6" Sewer and Drain Pipe & Fittings.					

# CATCH BASINS

## 12" Catch Basin Series



Part No.	Description	Color	Pkg. Qty.	Wt. Ea. (lbs.)	Product Class	Specifications
1200FF	12" Catch Basin Filter	Blue Frame/ Black Bag	8	0.10	10ND	Polypropylene Frame Fabric is non-woven geotextile 956 PM/SF.
Compatible with these basins: 1200, 1200NGB, 1203, 1204, 1216, 1217, 1225 NDS Catch Basins & Kits.						

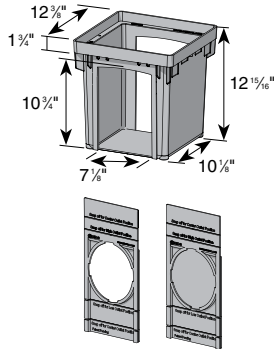

Part No.	Description	Color	Pkg. Qty.	Wt. Ea. (lbs.)	Product Class	Specifications
1200NGBKIT	12" x 12" Catch Basin, 2 Open Slides	Black	4	4.65	10ND	
1200NGB	12" x 12" Catch Basin	Black	4	3.45	10ND	
1207	Open Slide for 1200NGB	Black	8	0.60	10ND	
1208	Plug Slide for 1200NGB	Black	8	0.76	10ND	

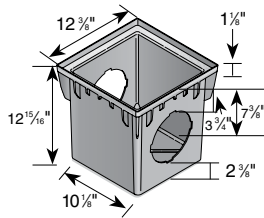

Part No.	Description	Color	Pkg. Qty.	Wt. Ea. (lbs.)	Product Class	Specifications
1200BLKIT	12" x 12" Catch Basin, 2 Open Sides	Black Grate	4	7.59	10ND	12" x 12" Tapered Catch Basin. Polypropylene.
1200GRKIT	12" x 12" Catch Basin, 2 Open Sides	Green Grate	4	7.59	10ND	
1200KITDISP	12" x 12" Catch Basin, 2 Open Sides	Black Grate	8	7.59	10ND	Kits include 2-opening Catch Basin, Grate, 2 Outlets and 1 Plug.
1200DGBLKITWH	12" Basin with Wave Decorative Grate	Black Grate	4	7.59	10ND	
1200DGGKITWH	12" Basin with Botanical Decorative Grate	Green Grate	4	7.59	10ND	DISP includes display box.
1200	12" x 12" Catch Basin, 2 Openings	Black	4	4.25	10ND	
1203	12" x 12" Catch Basin, 3 Openings	Black	4	3.75	10ND	
1204	12" x 12" Catch Basin, 4 Openings	Black	4	3.75	10ND	
Requires either #1206, #1242, #1243, #1245, #1266 or #1889 Universal Outlet to connect pipe to basin (see pages 32-33). Bottom cutout can be removed.						

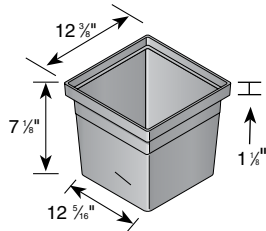

Part No.	Description	Color	Pkg. Qty.	Wt. Ea. (lbs.)	Product Class	Specifications
1216	12" x 12" Catch Basin Riser	Black	8	2.75	10ND	6" Riser for 12" Catch Basin. Styrene.
Use with 12" x 12" Catch Basin Series. Stacks on top of 12" catch basins to add up to 6" to top of basin. Can be cut to size.						

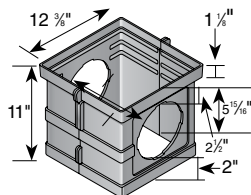

Part No.	Description	Color	Pkg. Qty.	Wt. Ea. (lbs.)	Product Class	Specifications
1217	12" x 12" Riser with 2 Openings	Black	4	4.00	10ND	12" Riser with Two Openings. Styrene.
Nests on top of 12" Catch Basin Series for shallow outlets and 12" Sump Box for more sump area. Requires either #1206, #1242, #1243, #1245, #1266 or #1889 Universal Outlet to connect pipe to riser.						

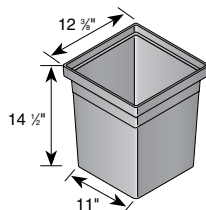

Part No.	Description	Color	Pkg. Qty.	Wt. Ea. (lbs.)	Product Class	Specifications
1225	12" x 12" Sump Box	Black	4	6.75	10ND	One-piece 12" Sump Box. Styrene.
Use with 12" x 12" Grate or #1220 Valve Box Cover.						

DRAINAGE

# CATCH BASINS

## 12" Catch Basin Series (continued)

DRAINAGE

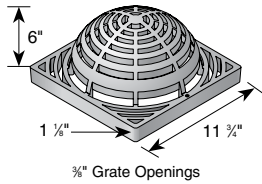

Part No.	Description	Color	Pkg. Qty.	Wt. Ea. (lbs.)	Product Class	Specifications
1280	12" x 12" Atrium Grate	Green	8	1.74	10ND	12" Structural Foam Polyolefin Dome Atrium Grate with UV inhibitor. Open surface area 50.60 square inches. 154.79 GPM.
1290	12" x 12" Atrium Grate	Black	8	1.74	10ND	
Use with 12" x 12" Catch Basin Series.						

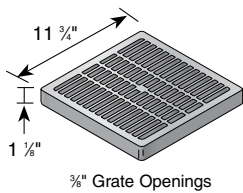

Part No.	Description	Color	Pkg. Qty.	Wt. Ea. (lbs.)	Product Class	Specifications
1210	12" x 12" Square Grate	Gray	8	2.33	10ND	12" Square Structural Foam Polyolefin Grate with UV inhibitor. Open surface area 50.76 square inches. 155.28 GPM.
1211	12" x 12" Square Grate	Black	8	2.33	10ND	
1212	12" x 12" Square Grate	Green	8	2.33	10ND	
1212S	12" x 12" Square Grate	Sand	8	2.33	10ND	
Use with 12" x 12" Catch Basin Series. (see page 74). ADA Compliant.						

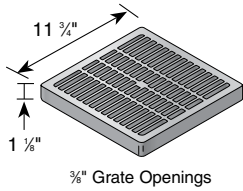

Part No.	Description	Color	Pkg. Qty.	Wt. Ea. (lbs.)	Product Class	Specifications
1230B	12" Square Brass Grate	Brass	1	9.24	15BR	Open surface area 42.87 square inches. 131.14 GPM. Includes SS Screws.
(see page 74). ADA Compliant.						

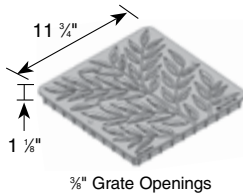

Part No.	Description	Color	Pkg. Qty.	Wt. Ea. (lbs.)	Product Class	Specifications
1218S	12" x 12" Square Botanical Grate	Sand	8	3.27	10ND	12" Square Structural Foam Polyolefin Botanical Grate with UV inhibitor. Open surface area 24.44 square inches. 74.77 GPM. Class B load rated.
1218GR	12" x 12" Square Botanical Grate	Green	8	3.27	10ND	
1218GY	12" x 12" Square Botanical Grate	Gray	8	3.27	10ND	
1218	12" x 12" Square Botanical Grate	Black	8	3.27	10ND	
839	Stainless Steel Screws, FH #6 x 1-3/4"	Metal	40	n/a	10ND	
(see page 74). ADA Compliant.						

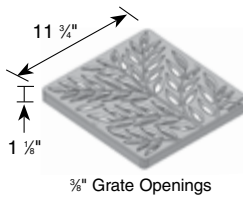

Part No.	Description	Color	Pkg. Qty.	Wt. Ea. (lbs.)	Product Class	Specifications
1218CI	12" x 12" Square Botanical Cast Iron Grate	Raw Iron	1	12.67	10ND	12" Square Cast Iron Botanical Grate. Open surface area 24.44 square inches. 74.77 GPM. Class B load rated.
629	Stainless Steel Screws, FH #20 x 1-1/2"	Metal	40	n/a	10ND	
(see page 74). ADA Compliant.						

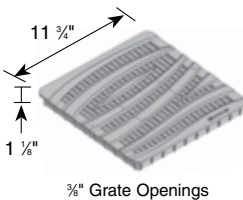

Part No.	Description	Color	Pkg. Qty.	Wt. Ea. (lbs.)	Product Class	Specifications
1224S	12" x 12" Square Wave Grate	Sand	8	2.68	10ND	12" Square Structural Foam Polyolefin Wave Grate with UV inhibitor. Open surface area 25.67 square inches. 78.53 GPM. Class B load rated.
1224GR	12" x 12" Square Wave Grate	Green	8	2.68	10ND	
1224GY	12" x 12" Square Wave Grate	Gray	8	2.68	10ND	
1224	12" x 12" Square Wave Grate	Black	8	2.68	10ND	
839	Stainless Steel Screws, FH #6 x 1-3/4"	Metal	40	n/a	10ND	
(see page 74). ADA Compliant.						

## CATCH BASINS

### 12" Catch Basin Series (continued)

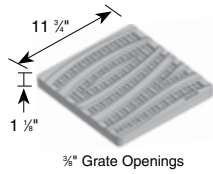

Part No.	Description	Color	Pkg. Qty.	Wt. Ea. (lbs.)	Product Class	Specifications
1224CI	12" x 12" Square Wave Cast Iron Grate	Raw Iron	1	13.90	10ND	12" Square Cast Iron Wave Grate. Open surface area 25.60 square inches. 78.31 GPM. Class B load rated.
629	Stainless Steel Screws, FH #20 x 1-1/2"	Metal	40	n/a	10ND	
	 (see page 74). ADA Compliant/Heel-proof.					

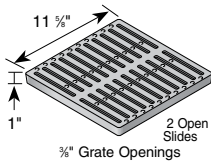

Part No.	Description	Color	Pkg. Qty.	Wt. Ea. (lbs.)	Product Class	Specifications
1213	12" x 12" Square Ductile Iron Grate	Black	1	15.30	10ND	12" Square Heavy-Duty Ductile Iron Grate. Open surface area 37.20 square inches. 113.80 GPM.
	 Use with 12" x 12" Catch Basin Series. (see page 74). ADA Compliant.					

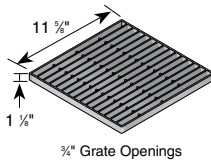

Part No.	Description	Color	Pkg. Qty.	Wt. Ea. (lbs.)	Product Class	Specifications
1215	12" x 12" Square Galvanized Steel Grate	Galvanized Steel	1	5.85	10ND	12" Square Heavy-Duty Galvanized Steel Bar Grate. Open surface area 113.78 square inches. 348.07 GPM.
	Use with 12" x 12" Catch Basin Series. (see page 74)					

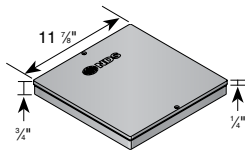

Part No.	Description	Color	Pkg. Qty.	Wt. Ea. (lbs.)	Product Class	Specifications
1220	12" x 12" Sump Pump Box	Black	8	2.23	10ND	NDS #1220, 12" Square Structural Foam Polyolefin Solid Cover.
	Use with NDS 12" x 12" Catch Basin Series and NDS #1219 Backwater Valve Box.					

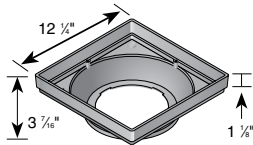

Part No.	Description	Color	Pkg. Qty.	Wt. Ea. (lbs.)	Product Class	Specifications
1230	12" x 12" Low-Profile Adapter	Black	8	1.25	10ND	12" x 12" Low-Profile Adapter. Styrene.
	Requires either #1243, #1245, #1266 or #1889 Universal Outlet for connection to 3", 4" or 6" Sewer and Drain or Corrugated Pipe. (see page 33)					

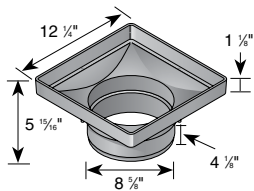

Part No.	Description	Color	Pkg. Qty.	Wt. Ea. (lbs.)	Product Class	Specifications
1221	12" x 12" Square, Low-Profile Adapter	Black	12	1.92	10ND	12" x 12" Low-Profile Adapter. Styrene.
1222	12" x 12" Square, Low-Profile Spigot Adapter	Black	12	1.92	10ND	
	Fits 8" Corrugated Pipe, Sch 40, Corrugated Spigot, S&D Hub.					

# CATCH BASINS

## 18" Catch Basin Series

DRAINAGE

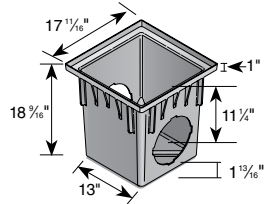

Part No.	Description	Color	Pkg. Qty.	Wt. Ea. (lbs.)	Product Class	Specifications
1882	18" One-Piece Catch Basin 2 Openings	Black	1	10.00	10ND	18"x18" One-Piece Tapered Catch Basin. Structural Foam Polyolefin.
1884	18" One-Piece Catch Basin 4 Openings	Black	1	9.65	10ND	
Requires either #1206, #1242, #1243, #1245, #1266, #1888 or #1889 Universal Outlet to connect pipe to basin. Includes 2 or 4 #1890 Reducer Rings.						

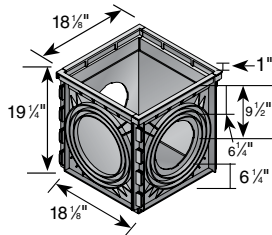

Part No.	Description	Color	Pkg. Qty.	Wt. Ea. (lbs.)	Product Class	Specifications
1800	18" x 18" Expandable Catch Basin 2 Openings*	Black	1	16.00	10ND	18" x 18" Modular Catch Basin with Locking Tabs. Styrene.
1804	18" x 18" Expandable Catch Basin 4 Openings*	Black	1	16.00	10ND	
Assembly Required. #1800 includes: 2 #1822, 2 #1820, 1 #1828. #1804 includes: 4 #1822, 1 #1828. Use #1800 and #1804 with #1206, #1243, #1245, #1266 or #1888 Universal Outlets to connect pipes to basin. Includes 2 or 4 #1890 Reducer Rings. (Note: Use Silicone to seal joints.)						

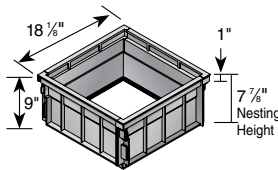

Part No.	Description	Color	Pkg. Qty.	Wt. Ea. (lbs.)	Product Class	Specifications
1816	8" Riser for 18" Catch Basin	Black	1	6.00	10ND	8" Riser for 18" x 18" Catch Basin. Styrene.
Riser package includes 4 sides. Use with #1800, #1804, #1882 or #1884.						

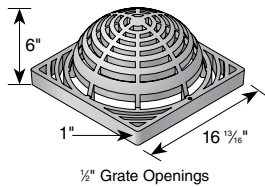

Part No.	Description	Color	Pkg. Qty.	Wt. Ea. (lbs.)	Product Class	Specifications
1881	18" x 18" Atrium Grate	Black	2	6.51	10ND	18" Structural Foam Polyolefin Dome Atrium Grate with UV inhibitor. Open surface area 89.40 square inches. 273.49 GPM.
1891	18" x 18" Atrium Grate	Green	2	6.51	10ND	
Use with 18" x 18" Catch Basin Series.						

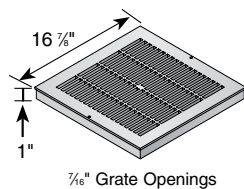

Part No.	Description	Color	Pkg. Qty.	Wt. Ea. (lbs.)	Product Class	Specifications
1810	18" x 18" Square Grate	Gray	4	7.72	10ND	18" Square Structural Foam Polyolefin Grate with UV inhibitor. Open surface area 86.31 square inches. 264.03 GPM.
1811	18" x 18" Square Grate	Black	4	7.72	10ND	
1812	18" x 18" Square Grate	Green	4	7.72	10ND	
Use with 18" x 18" Catch Basin Series. (see page 74). ADA Compliant.						

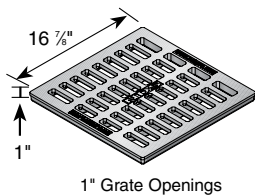

Part No.	Description	Color	Pkg. Qty.	Wt. Ea. (lbs.)	Product Class	Specifications
1813	18" x 18" Cast Iron Square Grate	Black	1	46.00	10ND	18" Square Heavy-Duty Cast Iron Grate. Open surface area 110.70 square inches. 338.65 GPM. H-20 Load Rating.
Use with 18" x 18" Catch Basin Series.						

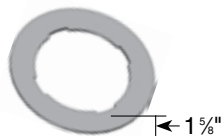

Part No.	Description	Color	Pkg. Qty.	Wt. Ea. (lbs.)	Product Class	Specifications
1890	Universal Outlet Reducer Ring	Black	8	0.33	10ND	Styrene.
Required on #1821 basin side when using 3", 4" or 6" pipe. Required on #1821 basin side when connecting to #1206, #1243, #1245, #1266 or #1889 Universal Outlets.						

## CATCH BASINS

### 18" Catch Basin Series (continued)

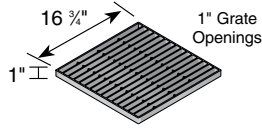

Part No.	Description	Color	Pkg. Qty.	Wt. Ea. (lbs.)	Product Class	Specifications
1815	18" Square Galvanized Steel Grate	Galvanized Steel	1	10.78	10ND	18" Square Heavy-Duty Galvanized Steel Bar Grate. Open surface area 239.00 square inches. 731.13 GPM.
	Use with 18" x 18" Catch Basin Series. (see page 74)					

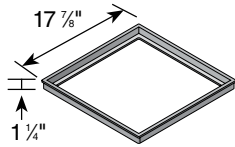

Part No.	Description	Color	Pkg. Qty.	Wt. Ea. (lbs.)	Product Class	Specifications
1840	Frame to adapt 18" x 18" grate to concrete catch basin	Black	4	2.00	10ND	18" x 18" Frame. Styrene.
	Use with 18" x 18" Grates.					

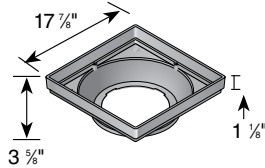

Part No.	Description	Color	Pkg. Qty.	Wt. Ea. (lbs.)	Product Class	Specifications
1830	18" x 18" Low-Profile Adapter	Black	4	4.75	10ND	18" x 18" Low-Profile Adapter. Styrene.
	Includes NDS #1890 Reducer Ring. Requires either an NDS #1243, #1245, #1266 or #1888 Universal Outlet to connect to pipe.					

### 18" Component Parts

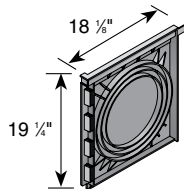

Part No.	Description	Color	Pkg. Qty.	Wt. Ea. (lbs.)	Product Class	Specifications
1820	Basin Side – No Opening	Black	4	4.00	10ND	18" x 18" Catch Basin Side, No Opening. Styrene.

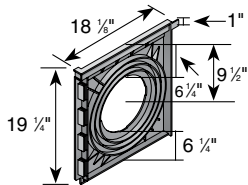

Part No.	Description	Color	Pkg. Qty.	Wt. Ea. (lbs.)	Product Class	Specifications
1821	Basin Side – 8" Opening	Black	4	4.00	10ND	18" x 18" Catch Basin Side, 8" Opening. Styrene.
	Reducer Ring not included. Requires #1888 Universal Outlet to fit 8" Corrugated Pipe or Sewer and Drain Pipe or #1266 Universal Outlets. #1889 Universal Outlet does not fit this #1821 Basin Side.					

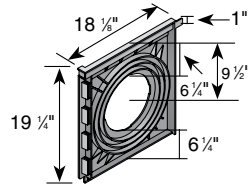

Part No.	Description	Color	Pkg. Qty.	Wt. Ea. (lbs.)	Product Class	Specifications
1822	Basin Side – 6" or 8" Opening	Black	4	3.75	10ND	18" x 18" Catch Basin Side, 6" or 8" Opening. Styrene.
	Opening using Universal Outlet. Includes #1890 Reducer Ring. Use with #1206, #1242, #1243, #1245, #1266 or #1888 Universal Outlets.					

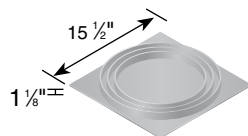

Part No.	Description	Color	Pkg. Qty.	Wt. Ea. (lbs.)	Product Class	Specifications
1828	Basin Bottom	Black	4	2.50	10ND	18" x 18" Catch Basin Bottom. Styrene.

# CATCH BASINS

## 24" Catch Basin Series

DRAINAGE

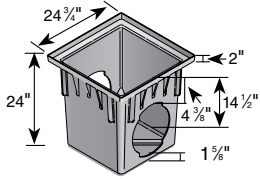

Part No.	Description	Color	Pkg. Qty.	Wt. Ea. (lbs.)	Product Class	Specifications
2400	24" x 24" Catch Basin, 2 Openings	Black	1	18.00	10ND	24" x 24" One-Piece Tapered Catch Basin. HDPE with Structural Foam.
2404	24" x 24" Catch Basin, 4 Openings	Black	1	15.00	10ND	
Requires 2 or 4 #2410 Universal Outlets.						

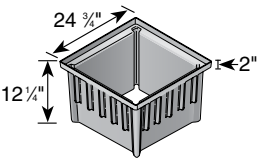

Part No.	Description	Color	Pkg. Qty.	Wt. Ea. (lbs.)	Product Class	Specifications
2418	24" x 24" Catch Basin Extension (No Bottom)	Black	1	14.60	10ND	8" Extension for 24" x 24" Catch Basin. HDPE with Structural Foam.
Use with 24" x 24" Catch Basin Series.						

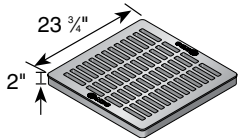

7/8" Grate Openings

Part No.	Description	Color	Pkg. Qty.	Wt. Ea. (lbs.)	Product Class	Specifications
2411	24" x 24" Square Grate	Black	1	19.75	10ND	24" Square HDPE with Structural Foam Grate with UV inhibitor. Open surface area 231.69 square inches. 708.77 GPM.
2412	24" x 24" Square Grate	Green	1	19.75	10ND	
Use with 24" x 24" Catch Basin Series. (see page 74)						

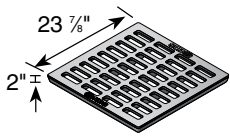

1" Grate Openings

Part No.	Description	Color	Pkg. Qty.	Wt. Ea. (lbs.)	Product Class	Specifications
2413	24" x 24" Square Cast Iron Grate	Black	1	147.00	10ND	24" Square Heavy-Duty Cast Iron Grate. Open surface area 197.00 square inches. 602.65 GPM. Structural Foam.
Use with 24" x 24" Catch Basin Series. (see page 74)						

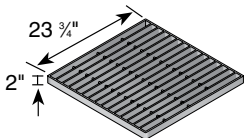

1 1/4" Grate Openings

Part No.	Description	Color	Pkg. Qty.	Wt. Ea. (lbs.)	Product Class	Specifications
2415	24" x 24" Square Galvanized Steel Grate	Galvanized Steel	1	62.88	10ND	24" Square Heavy-Duty Galvanized Steel Bar Grate. Open surface area 422.45 square inches. 1292.33 GPM. Structural Foam.
Use with 24" x 24" Catch Basin Series. (see page 74)						

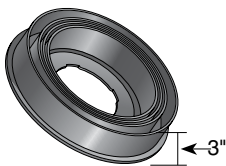

Part No.	Description	Color	Pkg. Qty.	Wt. Ea. (lbs.)	Product Class	Specifications
2410	10" & 12" Universal Adapter	Black	1	4.20	10ND	10"/12" Universal Adapter. HDPE.
Includes #1890 (comes pre-inserted). Fits 10" and 12" Sewer and Drain Pipe; 10" and 12" Dual Wall Corrugated Pipe; 12" Single Wall Corrugated Pipe (does not fit 10" Single Wall Corrugated Pipe). Reduces opening to fit most 3" to 8" adapters above (all except #1889) for use with 3", 4", 6" and 8" Sewer and Drain Pipe; 3", 4", 6" and 8" Corrugated Pipe; and 4" Sch. 40 Pipe (select corresponding adapter above). Use with 24" Catch Basin Series.						



## CATCH BASINS

### Catch Basin Universal Outlets

Universal Outlets and Adapters allow you to quickly connect to 3"-12" drain pipes to accommodate the needs of any job. They offer greater flexibility during install saving time and money.

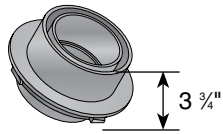

Part No.	Description	Color	Pkg. Qty.	Wt. Ea. (lbs.)	Product Class	Specifications
1242	3" & 4" Universal Outlet w/4" Spigot	Black	20	0.74	10ND	3" & 4" Universal Outlet. Styrene.
Fits 3" & 4" Corrugated Pipe, 3" & 4" Sewer and Drain Pipe, 4" Sch. 40 Pipe, 4" Triple Wall Pipe. Allows for adjusting inlet height. Use with 9", 12", 18" and 24" Catch Basin Series. Use with 24" Catch Basin also requires #2410 Adapter.						

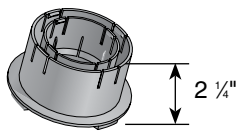

Part No.	Description	Color	Pkg. Qty.	Wt. Ea. (lbs.)	Product Class	Specifications
1243	3" & 4" Universal Locking Outlet*	Black	20	0.60	10ND	3" & 4" Patented Universal Locking Outlet. Styrene.
Fits 3" & 4" Corrugated Pipe, 3" & 4" Sewer and Drain Pipe, 4" Sch. 40 Pipe and 3" & 4" Triple Wall Pipe. Use with 9", 12", 18" and 24" Catch Basin Series and #930, #1230, #1830 and #2410 Adapters. Use with 24" Catch Basin also requires #2410 Adapter.						
*New Locking Outlet snaps on to most 3" and 4" corrugated pipe.						

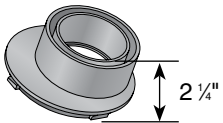

Part No.	Description	Color	Pkg. Qty.	Wt. Ea. (lbs.)	Product Class	Specifications
1245	3" & 4" Offset Universal Outlet	Black	20	0.50	10ND	3" & 4" Offset Universal Outlet. Styrene.
Fits 3" & 4" Corrugated Pipe, 3" & 4" Sewer and Drain Pipe, 4" Sch. 40 Pipe, 4" Triple Wall Pipe. Allows for adjusting inlet height. Use with 9", 12", 18" and 24" Catch Basin Series. Use with 24" Catch Basin also requires #2410 Adapter.						

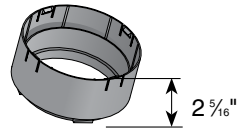

Part No.	Description	Color	Pkg. Qty.	Wt. Ea. (lbs.)	Product Class	Specifications
1266	6" Universal Locking Outlet*	Black	20	0.55	10ND	6" Universal Locking Outlet. Styrene.
Fits 6" Sewer and Drain Pipe, 6" Corrugated Pipe. Use with 9", 12", 18" and 24" Catch Basin Series and #930, #1230 and #1830 Low-Profile Adapters. Use with 24" Catch Basin also requires #2410 Adapter.						
*New, improved Locking Outlet snaps on to most 6" corrugated pipe.						

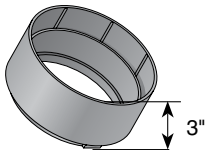

Part No.	Description	Color	Pkg. Qty.	Wt. Ea. (lbs.)	Product Class	Specifications
1888	8" Universal Outlet	Black	8	1.05	10ND	8" Universal Outlet. Styrene.
Fits 8" Sewer and Drain Pipe, 8" Corrugated Pipe. Use with 18" and 24" Catch Basin Series. Use with 24" Catch Basin also requires #2410 Adapter.						

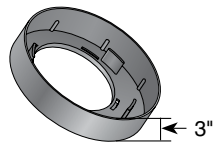

Part No.	Description	Color	Pkg. Qty.	Wt. Ea. (lbs.)	Product Class	Specifications
1889	8" Offset Universal Adapter	Black	10	0.74	10ND	8" Offset Universal Adapter. Styrene.
Fits 8" Sewer and Drain Pipe, 8" Corrugated Pipe. Use with 12" and most 18" Catch Basin Series (except 1800 and 1804).						

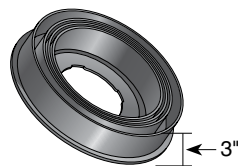

Part No.	Description	Color	Pkg. Qty.	Wt. Ea. (lbs.)	Product Class	Specifications
2410	10" & 12" Universal Adapter	Black	1	4.20	10ND	10"/12" Universal Adapter. HDPE.
Includes #1890 (comes pre-inserted). Fits 10" and 12" Sewer and Drain Pipe; 10" and 12" Dual Wall Corrugated Pipe; 12" Single Wall Corrugated Pipe (does not fit 10" Single Wall Corrugated Pipe). Reduces opening to fit most 3" to 8" adapters above (all except #1889) for use with 3", 4", 6" and 8" Sewer and Drain Pipe; 3", 4", 6" and 8" Corrugated Pipe; and 4" Sch. 40 Pipe (select corresponding adapter above). Use with 24" Catch Basin Series.						

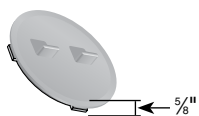

Part No.	Description	Color	Pkg. Qty.	Wt. Ea. (lbs.)	Product Class	Specifications
1206	6" Universal Adapter Plug	Black	20	0.35	10ND	Universal Plug. Styrene.

DRAINAGE

## POP-UP DRAINAGE EMITTERS

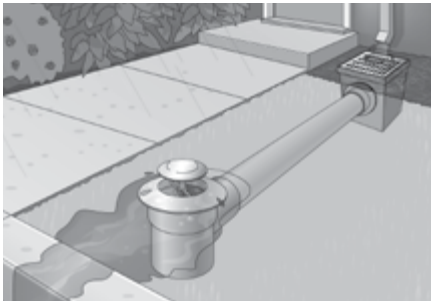

The Pop-up Drainage Emitter is an easy, safe and efficient solution that allows water to be diverted and released to water-safe areas away from structures, erosion-prone landscapes and poor drainage areas.

Pop-up Drainage Emitters allow water captured by grates, catch basins, channel drains, Flo-Well, EZflow, downspouts and roof gutter systems to flow through drainage pipe and away from structural foundations to safe or useful areas. For example, water can be routed from a low area next to a foundation to a water-safe area in the landscape, or a curbside drainage system where allowed. The emitter opens under minimal hydrostatic pressure from water through upstream drainage pipes; the emitter closes as flow diminishes. The special patented design allows the Emitter to open with even the smallest flows. Since the Emitter is closed during dry weather, debris and rodents cannot enter the drain pipes. Spring automatically retracts – closes and prevents damage from lawn mowers. It's flat profile blends discreetly into the surrounding landscapes.

### 3" & 4" Pop-up Drainage Emitter

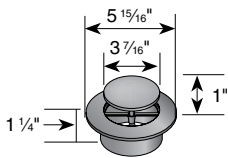

Part No.	Description	Color	Pkg. Qty.	Wt. Ea. (lbs.)	Product Class	Specifications
420	3" & 4" Pop-up Drainage Emitter Fits 3" and 4" Sewer and Drain Fittings. Ideal for discharging excess water from stormwater management system. Spring automatically retracts.	Green	20	0.28	10ND	3" and 4" polyolefin spring-loaded Pop-up Drainage Emitter with UV inhibitor. 40 GPM capacity. 0.04 psi or 1" of head to raise top.

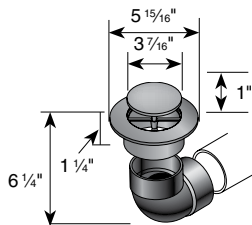

Part No.	Description	Color	Pkg. Qty.	Wt. Ea. (lbs.)	Product Class	Specifications
321	Emitter with 3" Elbow Fits 3" Sewer and Drain Pipe. Ideal for discharging excess water from stormwater management system. Spring automatically retracts.	Green	25	0.60	10ND	NDS #420 polyolefin spring-loaded Pop-up Drainage Emitter with UV inhibitor, 3" styrene 90 degree elbow with 1/4" drain hole. 40 GPM. 0.04 psi or 1" of head to raise top.

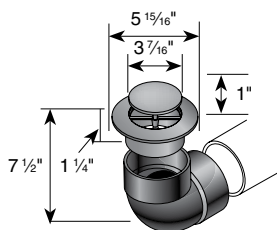

Part No.	Description	Color	Pkg. Qty.	Wt. Ea. (lbs.)	Product Class	Specifications
421	Emitter with 4" Elbow Fits 4" Sewer and Drain Pipe. Ideal for discharging excess water from stormwater management system. Spring automatically retracts.	Green	20	0.85	10ND	NDS #420 polyolefin spring-loaded Pop-up Drainage Emitter with UV inhibitor, 4" styrene 90 degree elbow with 1/4" drain hole. 40 GPM. 0.04 psi or 1" of head to raise top.

## POP-UP DRAINAGE EMITTERS

### 3" & 4" Pop-up Drainage Emitter (continued)

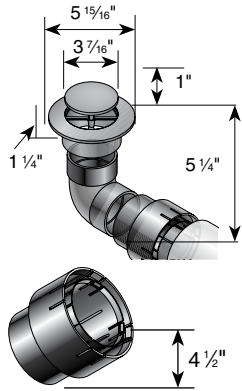

Part No.	Description	Color	Pkg. Qty.	Wt. Ea. (lbs.)	Product Class	Specifications
430	Pop-up Drainage Emitter with 3" Elbow and Universal Adapter	Green	20	1.00	10ND	NDS #420 polyolefin spring-loaded Pop-up Drainage Emitter with UV inhibitor, 3" styrene 90 degree elbow with 1/4" drain hole and universal pipe adapter. 40 GPM. 0.04 psi or 1" of head to raise top.
1241	3" & 4" Universal Adapter w/4" Spigot	Blacj	20	0.70	10ND	3" & 4" Patented Universal Adapter. Styrene.

### 6" Pop-up Drainage Emitter

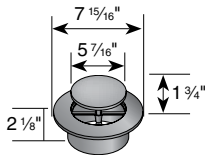

Part No.	Description	Color	Pkg. Qty.	Wt. Ea. (lbs.)	Product Class	Specifications
620	6" Pop-up Drainage Emitter	Green	15	0.61	10ND	6" polyolefin spring-loaded Pop-up Drainage Emitter with UV inhibitor. 88 GPM capacity. 0.04 psi or 1" of head to raise top.

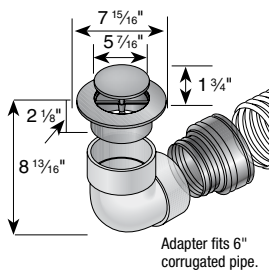

Part No.	Description	Color	Pkg. Qty.	Wt. Ea. (lbs.)	Product Class	Specifications
624	6" Pop-up Emitter with Elbow and Corrugated Pipe Adapter	Green	10	3.45	10ND	NDS #620 polyolefin spring-loaded Pop-up Drainage Emitter with UV inhibitor, 6" styrene 90 degree elbow with 1/4" drain hole and corrugated pipe adapter. 88 GPM. 0.04 psi or 1" of head to raise top.

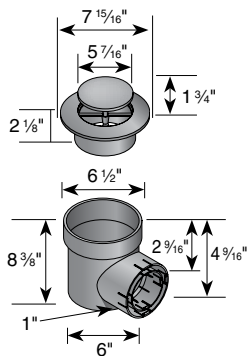

Part No.	Description	Color	Pkg. Qty.	Wt. Ea. (lbs.)	Product Class	Specifications
625	6" Pop-up Emitter with Spee-D® Basin	Green	8	2.21	10ND	NDS #620 polyolefin spring-loaded Pop-up Drainage Emitter with UV inhibitor and Spee-D basin. 88 GPM. 0.04 psi or 1" of head to raise top.

DRAINAGE

## COMMON DRAINAGE FITTINGS

### 90 Degree PVC Elbow

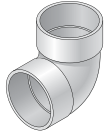

	Part No.	Description	Color	Pkg. Qty.	Wt. Ea. (lbs.)	Product Class
PVC	3P02	3" PVC 90 Degree Elbow (HUB x HUB)	White	40	0.40	30PV
	4P02	4" PVC 90 Degree Elbow (HUB x HUB)	White	25	0.68	30PV
	6P02	6" PVC 90° Elbow (HUB x HUB)	White	12	3.00	30PV

DRAINAGE

### Corrugated Adapter

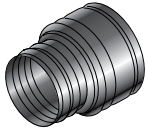

Part No.	Description	Color	Pkg. Qty.	Wt. Ea. (lbs.)	Product Class
351	3" Polyethylene Corrugated Adapter (CORR HUB x S&D SPT or HUB)	Black	50	0.10	30ST
451	4" Polyethylene Corrugated Adapter (CORR HUB x S&D SPT or HUB)	Black	25	0.20	30ST
651	6" Polyethylene Corrugated Adapter (CORR HUB x S&D SPT or HUB)	Black	12	0.25	30ST

### Corrugated Internal Couplings

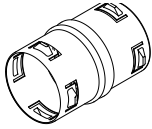

Part No.	Description	Color	Pkg. Qty.	Wt. Ea. (lbs.)	Product Class
3C05	3" Corrugated Coupling	Black	60	0.07	30PE
4C07	4" Corrugated Coupling	Black	36	0.08	30PE
6C07	6" Corrugated Coupling	Black	12	0.08	30PE

### Corrugate End Caps

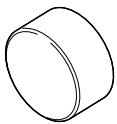

Part No.	Description	Color	Pkg. Qty.	Wt. Ea. (lbs.)	Product Class
3C06	3" Corrugated Endcap	Black	33	0.05	30PE
4C06	4" Corrugated Endcap	Black	30	0.06	30PE
6C06	6" Corrugated Endcap	Black	15	0.50	30PE

Note: See Fittings section (pages 156-173) for additional fitting options.

## GRATES: STANDARD, DECORATIVE & METAL

---



NDS offers a variety of grates in sizes, patterns, colors and design options to fit all products and enhance any landscape.

### Brass & Chrome Grates

---



### Strong – Practical – Functional

---

Our solid cast brass grates are secured to a PVC collar with solid brass screws for aesthetics and reliability. The PVC collar can be solvent welded into sewer and drain fittings or pipe where permanent, anti-theft installation is desired. The grate can still be removed for easy cleanout.

- A unique mix of beauty and function
- Recommended for highly-visible entry areas in hotels, malls, office buildings, country clubs and estates
- Exceptional construction and fine finish also make these grates ideal for deck areas, walkways, swimming pools and spas

### Materials & Standards

---

- Made with the highest-quality solid brass
- Brushed Satin and Polished Chrome finishes are protected by a clear plastic film that prevents damage to the finish during shipping and installation

# GRATES: STANDARD, DECORATIVE & METAL

## Brass & Chrome Grates

DRAINAGE

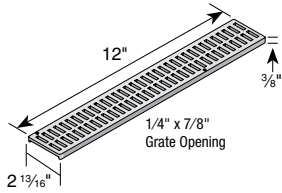

Part No.	Description	Color	Pkg. Qty.	Wt. Ea. lbs.	Product Class	Specifications
552B	1 ft. Brass Channel Grate	Satin Brass	12	1.21	25PF	1 foot Mini Channel Solid Brass Grate with brass screws. Open surface area 9.20 square inches per foot. 28.14 GPM per foot.
553PB	1 ft. Brass Channel Grate	Polished Brass	12	1.21	25PF	
 Fits #500 and #550 Mini Channels. (see page 50). (see page 74). ADA Compliant/Heel-proof.						

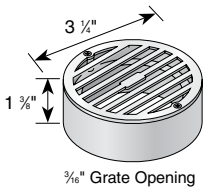

Part No.	Description	Color	Pkg. Qty.	Wt. Ea. lbs.	Product Class	Specifications
909B	3" Round Brass Grate w/PVC Collar	Satin Brass	20	0.40	15BR	3" Round Solid Brass Grate and brass screws with PVC collar. Open surface area 2.68 square inches. 8.20 GPM.
905PB	3" Round Brass Grate w/PVC Collar	Polished Brass	20	0.40	15BR	
 Fits 2" SCH-40 Pipe and 3" Sewer and Drain Fittings. (see page 74). ADA Compliant/Heel-proof.						

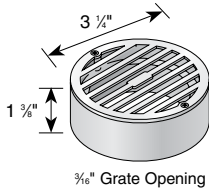

Part No.	Description	Color	Pkg. Qty.	Wt. Ea. lbs.	Product Class	Specifications
915SC	3" Round Chrome Grate w/PVC Collar	Satin Chrome	20	0.40	15BR	3" Round Solid Chrome Grate and screws with PVC collar. Open surface area 2.68 square inches. 8.20 GPM.
907PB	3" Round Chrome Grate w/PVC Collar	Polished Chrome	20	0.40	15BR	
 Fits 3" Sewer and Drain Fittings and 2" SCH-40 Pipe. (see page 74). ADA Compliant/Heel-proof.						

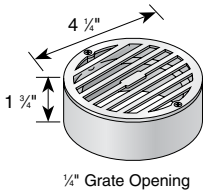

Part No.	Description	Color	Pkg. Qty.	Wt. Ea. lbs.	Product Class	Specifications
910B	4" Round Brass Grate w/PVC Collar	Satin Brass	20	0.64	15BR	4" Round Solid Brass Grate and brass screws with PVC collar. Open surface area 5.25 square inches. 16.06 GPM.
906PB	4" Round Brass Grate w/PVC Collar	Polished Brass	20	0.64	15BR	
 Fits 3" Sewer & Drain Pipe, 4" Sewer & Drain Fittings. (see page 74). ADA Compliant/Heel-proof.						

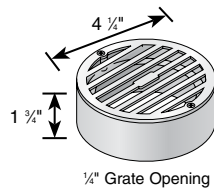

Part No.	Description	Color	Pkg. Qty.	Wt. Ea. lbs.	Product Class	Specifications
917SC	4" Round Chrome Grate w/PVC Collar	Satin Chrome	20	0.66	15BR	4" Round Chrome Grate and screws with PVC collar. Open surface area 5.25 square inches. 16.06 GPM.
908PC	4" Round Chrome Grate w/PVC Collar	Polished Chrome	20	0.66	15BR	
 Fits 3" Sewer & Drain Pipe, 4" Sewer & Drain Fittings. (see page 74). ADA Compliant/Heel-proof.						

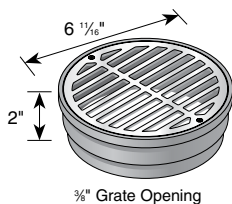

Part No.	Description	Color	Pkg. Qty.	Wt. Ea. lbs.	Product Class	Specifications
918B	6" Round Brass Grate w/Styrene Collar	Satin Brass	8	1.38	15BR	6" Round Solid Brass Grate and brass screws with styrene collar. Open surface area 13.10 square inches. 40.07 GPM.
919PB	6" Round Brass Grate w/Styrene Collar	Polished Brass	8	1.38	15BR	
 Fits Spee-D® Basin, 6" Sewer & Drain Fittings. (see page 74). ADA Compliant.						

## GRATES: STANDARD, DECORATIVE & METAL

### Brass & Chrome Grates (continued)

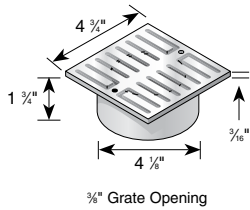

Part No.	Description	Color	Pkg. Qty.	Wt. Ea. lbs.	Product Class	Specifications
913B	5" Square Brass Grate w/PVC Collar	Satin Brass	10	1.21	15BR	5" Square Solid Brass Grate with brass screws and PVC collar. Open surface area 2.5 square inches. 7.65 GPM.
914PB	5" Square Brass Grate w/PVC Collar	Polished Brass	10	1.21	15BR	
Fits 4" Sewer and Drain Fittings, 3" Sewer and Drain Pipe, and 3" Triple Wall Pipe. (see page 74). ADA Compliant.						

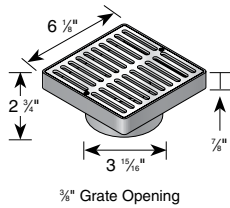

Part No.	Description	Color	Pkg. Qty.	Wt. Ea. lbs.	Product Class	Specifications
920B	6" Square Brass Grate w/Styrene Adapter	Satin Brass	8	1.65	15BR	6" Square Solid Brass Grate with brass-colored styrene low-profile adapter and brass screws. Open surface area 11.60 square inches. 35.49 GPM.
923PB	6" Square Brass Grate w/Styrene Adapter	Polished Brass	8	1.65	15BR	
Fits 3" or 4" Sewer and Drain Pipe or Fittings, 3" or 4" Corrugated Pipe, and 3" or 4" Triple Wall Pipe. (see page 74). ADA Compliant.						

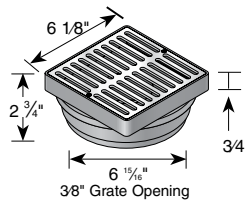

Part No.	Description	Color	Pkg. Qty.	Wt. Ea. lbs.	Product Class	Specifications
921B	6" Square Brass Grate w/Styrene Adapter	Satin Brass	8	1.71	15BR	6" Square Solid Brass Grate with brass-colored styrene low-profile adapter and brass screws. Open surface area 11.60 square inches. 35.49 GPM.
922PB	6" Square Brass Grate w/Styrene Adapter	Polished Brass	8	1.70	15BR	
Fits Spee-D® Basin, 6" Sewer and Drain Pipe & Fittings. (see page 74). ADA Compliant.						

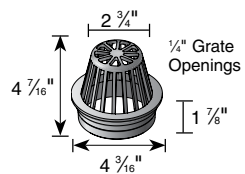

Part No.	Description	Color	Pkg. Qty.	Wt. Ea. lbs.	Product Class	Specifications
78B	4" Atrium Brass Grate	Brass	1	2.00	15BR	Open surface area 10.20 square inches. 31.20 GPM.
Fits 4" Sewer and Drain Pipe & Fittings.						

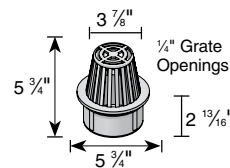

Part No.	Description	Color	Pkg. Qty.	Wt. Ea. lbs.	Product Class	Specifications
90B	6" Atrium Brass Grate	Brass	1	5.30	15BR	Open surface area 22.50 square inches. 68.83 GPM.
Fits 6" Sewer and Drain Pipe & Fittings.						

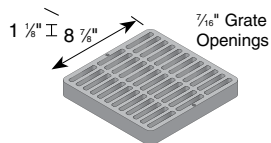

Part No.	Description	Color	Pkg. Qty.	Wt. Ea. lbs.	Product Class	Specifications
930B	9" Square Brass Grate	Brass	1	5.11	15BR	Open surface area 34.00 square inches. 104.01 GPM. Includes SS Screws.
(see page 74). ADA Compliant.						

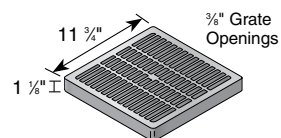

Part No.	Description	Color	Pkg. Qty.	Wt. Ea. lbs.	Product Class	Specifications
1230B	12" Square Brass Grate	Brass	1	9.24	15BR	Open surface area 42.87 square inches. 131.14 GPM. Includes SS Screws.
(see page 74). ADA Compliant.						

DRAINAGE

# GRATES: STANDARD, DECORATIVE & METAL

## Decorative Grates

Designed to meet today's demand for products that are as beautiful as they are functional. NDS decorative grates feature consumer-tested designs and offer a range of colors and materials ideal for any application or setting.



DRAINAGE

## Catch Basin Plastic & Metal Decorative Grates

Fits 12" Catch Basins. Available in Botanical and Wave designs, in multiple colors or in cast iron. Plastic grates are "T-top" and overlap basin edge. Iron grates sit flush.

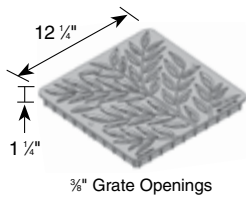

Part No.	Description	Color	Pkg. Qty.	Wt. Ea. (lbs.)	Product Class	Specifications
1218S	12" x 12" Square Botanical Grate	Sand	8	3.27	10ND	12" Square Structural Foam Polyolefin Botanical Grate with UV inhibitor. Open surface area 24.44 square inches. 74.77 GPM. Class B load rated.
1218GR	12" x 12" Square Botanical Grate	Green	8	3.27	10ND	
1218GY	12" x 12" Square Botanical Grate	Gray	8	3.27	10ND	
1218	12" x 12" Square Botanical Grate	Black	8	3.27	10ND	
839	#6 x 1-3/4 FH Phillips Screw	Metal	40	n/a	10ND	
Use Screw # 839, FH#6 x 1-3/4". (see page 74). ADA Compliant.						

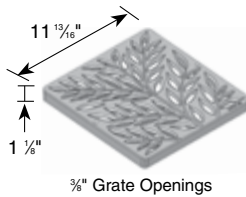

Part No.	Description	Color	Pkg. Qty.	Wt. Ea. (lbs.)	Product Class	Specifications
1218CI	12" x 12" Square Botanical Cast Iron Grate	Raw Iron	1	12.67	10ND	12" Square Cast Iron Botanical Grate. Open surface area 24.44 square inches. 74.77 GPM. Class B load rated.
629	#20 x 1-1/2 FH Phillips Screw	Metal	40	n/a	10ND	
Use Screw # 629, FH#20 x 1-1/2". (see page 74). ADA Compliant.						

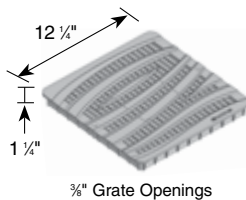

Part No.	Description	Color	Pkg. Qty.	Wt. Ea. (lbs.)	Product Class	Specifications
1224S	12" x 12" Square Wave Grate	Sand	8	2.68	10ND	12" Square Structural Foam Polyolefin Wave Grate with UV inhibitor. Open surface area 25.67 square inches. 78.53 GPM. Class B load rated.
1224GR	12" x 12" Square Wave Grate	Green	8	2.68	10ND	
1224GY	12" x 12" Square Wave Grate	Gray	8	2.68	10ND	
1224	12" x 12" Square Wave Grate	Black	8	2.68	10ND	
839	#6 x 1-3/4 FH Phillips Screw	Metal	40	n/a	10ND	
Use Screw # 839, FH#6 x 1-3/4". (see page 74). ADA Compliant.						

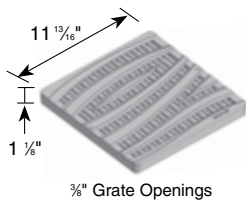

Part No.	Description	Color	Pkg. Qty.	Wt. Ea. (lbs.)	Product Class	Specifications
1224CI	12" x 12" Square Wave Cast Iron Grate	Raw Iron	1	13.90	10ND	12" Square Cast Iron Wave Grate. Open surface area 25.60 square inches. 78.31 GPM. Class B load rated.
629	#20 x 1-1/2 FH Phillips Screw	Metal	40	n/a	10ND	
Use Screw # 629, FH#20 x 1-1/2". (see page 74). ADA Compliant.						



## GRATES: STANDARD, DECORATIVE & METAL

### Mini Channel Plastic & Metal Decorative Grates

Fits 500 Series Mini Channel. Available in Botanical and Wave designs, in multiple colors or in cast iron. Plastic grates are "T-top" and overlap basin edge. Iron grates sit flush.

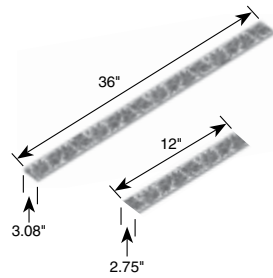

Part No.	Description	Color	Pkg. Qty.	Wt. Ea. (lbs.)	Product Class	Specifications
846	Stainless Steel Screws, FH #4 x 5/8"	Steel	64	0.10	25PF	3 ft. Structural Foam Polyolefin botanical pattern Channel Grate with UV inhibitor. Open surface area 5.44 square inches per foot. 16.64 GPM per foot.
554S	3' Botanical Channel Grate	Sand	16	0.89	25PF	
554GR	3' Botanical Channel Grate	Green	16	0.89	25PF	
554GY	3' Botanical Channel Grate	Gray	16	0.89	25PF	
553	3' Botanical Channel Grate	Black	16	0.89	25PF	
554CI	1' Botanical Cast Iron Channel Grate	Raw Iron	1	1.82	10ND	1 ft. Mini Channel botanical Cast Iron Channel Grate. Open surface area 5.39 square inches per foot. 16.49 GPM per foot. Class B load rated.
629	#20 x 1-1/2 FH Phillips Screw	Metal	40	n/a	10ND	
 (see page 74). ADA Compliant.						

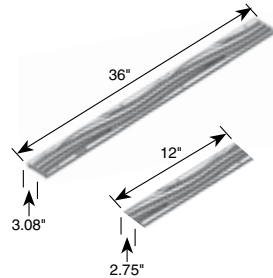

Part No.	Description	Color	Pkg. Qty.	Wt. Ea. (lbs.)	Product Class	Specifications
846	Stainless Steel Screws, FH #4 x 5/8"	Steel	64	0.10	25PF	3 ft. Structural Foam Polyolefin wave pattern Channel Grate with UV inhibitor. Open surface area 5.73 square inches per foot. 17.54 GPM per foot.
555S	3' Wave Channel Grate	Sand	16	0.88	25PF	
555GR	3' Wave Channel Grate	Green	16	0.88	25PF	
555GY	3' Wave Channel Grate	Gray	16	0.88	25PF	
555	3' Wave Channel Grate	Black	16	0.88	25PF	
555CI	1' Wave Cast Iron Channel Grate	Raw Iron	1	1.30	10ND	1 ft. Mini Channel Wave Cast Iron Channel Grate. Open surface area 4.11 square inches per foot. 12.56 GPM per foot. Class B load rated.
629	#20 x 1-1/2 FH Phillips Screw	Metal	40	n/a	10ND	
 (see page 74). ADA Compliant.						

### Spee-D® Channel Plastic & Metal Decorative Grates

Fits Spee-D® Channel. Available in Botanical and Wave designs, in multiple colors or in cast iron. Plastic grates are "T-top" and overlap basin edge. Iron grates sit flush.

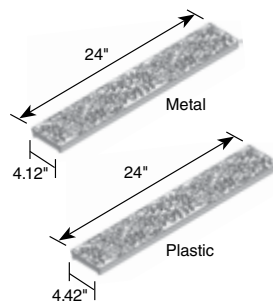

Part No.	Description	Color	Pkg. Qty.	Wt. Ea. (lbs.)	Product Class	Specifications
829	Stainless Steel Screws, FH #8 x 1"	Steel	48	0.06	25PF	2 ft. Structural Foam Polyolefin decorative botanical Channel Grate with UV inhibitor. Open surface area 7.78 square inches per foot. 23.80 GPM per foot.
252S	2' Channel Botanical Grate	Sand	24 ft.	1.74	25PF	
252GR	2' Channel Botanical Grate	Green	24 ft.	1.74	25PF	
252GY	2' Channel Botanical Grate	Gray	24 ft.	1.74	25PF	
252	2' Channel Botanical Grate	Black	24 ft.	1.74	25PF	
252CI	2' Cast Iron Channel Botanical Grate	Raw Iron	1 ft.	7.06	25PF	2 ft. Cast Iron decorative botanical Channel Grate. Open surface area 8.99 square inches per foot. 27.50 GPM per foot. Class B load rated.
629	#20 x 1-1/2 FH Phillips Screw	Metal	40	n/a	10ND	
 (see page 74). ADA Compliant.						

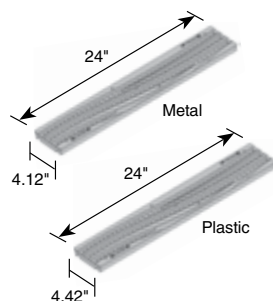

Part No.	Description	Color	Pkg. Qty.	Wt. Ea. (lbs.)	Product Class	Specifications
829	Stainless Steel Screws, FH #8 x 1"	Steel	48	0.06	25PF	2 ft. Structural Foam Polyolefin decorative wave Channel Grate with UV inhibitor. Open surface area 7.78 square inches per foot. 23.80 GPM per foot.
253S	2' Channel Wave Grate	Sand	24 ft.	1.84	25PF	
253GR	2' Channel Wave Grate	Green	24 ft.	1.84	25PF	
253GY	2' Channel Wave Grate	Gray	24 ft.	1.84	25PF	
253	2' Channel Wave Grate	Black	24 ft.	1.84	25PF	
253CI	2' Cast Iron Channel Wave Grate	Raw Iron	2 ft.	7.52	25PF	2 ft. Cast Iron decorative wave Channel Grate. Open surface area 7.41 square inches per foot. 22.67 GPM per foot. Class B load rated.
629	#20 x 1-1/2 FH Phillips Screw	Metal	40	n/a	10ND	
 (see page 74). ADA Compliant.						

DRAINAGE

# GRATES: STANDARD, DECORATIVE & METAL

## Dura Slope Metal Decorative Grates

Fits all Dura Slope channels. Available in five designs: Weave, Tile, Brick, Diamond and Slot. Ductile iron material, rated Class D and ADA compliant.

DRAINAGE

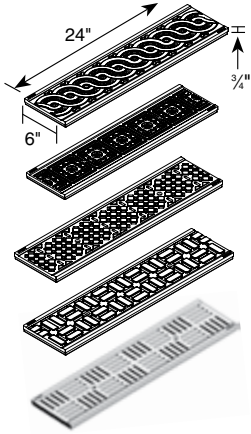

Part No.	Description	Color	Pkg. Qty.	Wt. Ea. (lbs.)	Product Class	Specifications
DS-601	Weave Pattern	Raw Iron	1	14.50	25DS	Decorative grates are made of ductile iron. <b>Weave:</b> open area 6.75 square inches per foot; 20.65 GPM. <b>Diamond:</b> open area 9.55 square inches per foot; 29.21 GPM. <b>Tile:</b> open area 7.95 square inches per foot; 24.32 GPM. <b>Brick:</b> open area 11.35 square inches per foot; 34.725 GPM. <b>Deco slot:</b> open area 16.75 square inches per foot; 51.24 GPM.
DS-602	Diamond Pattern	Raw Iron	1	14.30	25DS	
DS-603	Tile Pattern	Raw Iron	1	14.70	25DS	
DS-604	Brick Pattern	Raw Iron	1	14.30	25DS	
DS-609	Deco Slot	Raw Iron	1	14.50	25DS	
<p>Use with Dura Slope Drains (page 51), Dura Slope Catch Basins (page 53).</p> <p>Decorative grates are made of ductile iron. Uncoated raw iron will develop a rust patina over time. Additional powder-coat colors available: Black (K), White (W), Silver (S), Bronze (Z), Green (G), Blue (B), Orange (O), Gray (Y), Brown (N)</p> <p>MTO 6-7 week lead time.</p> <p>(see page 74). ADA Compliant/Heelproof. Must be used with DS-200H to achieve Class D Load Rating.</p>						

## Round Grates

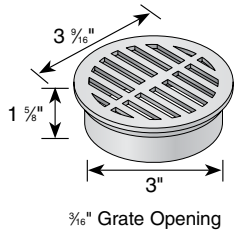

Part No.	Description	Color	Pkg. Qty.	Wt. Ea. lbs.	Product Class	Specifications
14	3" Round Grate	Black	40	0.13	10ND	3" Round Structural Foam Polyolefin Grate with UV inhibitor. Open surface area 2.60 square inches. 7.95 GPM.
15	3" Round Grate	Gray	40	0.13	10ND	
16	3" Round Grate	Green	40	0.13	10ND	
16P	3" Round Grate	Purple	40	0.13	10ND	
16S	3" Round Grate	Sand	40	0.13	10ND	
<p>Fits 3" Sewer and Drain Pipe &amp; Fittings, 3" Corrugated Pipe, and 3" Triple Wall Pipe.</p> <p>(see page 74). ADA Compliant/Heel-proof.</p>						

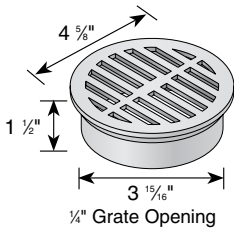

Part No.	Description	Color	Pkg. Qty.	Wt. Ea. lbs.	Product Class	Specifications
11	4" Round Grate	Black	25	0.17	10ND	4" Round Structural Foam Polyolefin Grate with UV inhibitor. Open surface area 3.85 square inches. 11.78 GPM.
12	4" Round Grate	Gray	25	0.17	10ND	
13	4" Round Grate	Green	25	0.17	10ND	
13P	4" Round Grate	Purple	25	0.17	10ND	
13S	4" Round Grate	Sand	25	0.17	10ND	
<p>Fits 4" Sewer and Drain Pipe &amp; Fittings, 4" Corrugated Pipe, and 4" Triple Wall Pipe.</p> <p>(see page 74). ADA Compliant/Heel-proof.</p>						

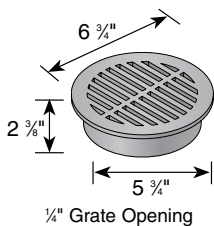

Part No.	Description	Color	Pkg. Qty.	Wt. Ea. lbs.	Product Class	Specifications
40	6" Round Grate	Black	10	0.49	10ND	6" Round Structural Foam Polyolefin Grate with UV inhibitor. Open surface area 9.10 square inches. 27.84 GPM.
50	6" Round Grate	Green	10	0.49	10ND	
60	6" Round Grate	Gray	10	0.49	10ND	
60S	6" Round Grate	Sand	10	0.49	10ND	
<p>Fits Spee-D® Basin, 6" Sewer and Drain Pipe &amp; Fittings and 6" Corrugated Pipe.</p> <p>(see page 74). ADA Compliant/Heel-proof.</p>						

## GRATES: STANDARD, DECORATIVE & METAL

### Round Grates

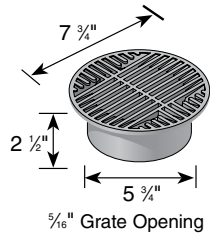

Part No.	Description	Color	Pkg. Qty.	Wt. Ea. lbs.	Product Class	Specifications
10	8" Round Grate	Black	10	0.60	10ND	8" Round Structural Foam Polyolefin Grate with UV inhibitor. Open surface area 11.50 square inches. 35.18 GPM.
20	8" Round Grate	Green	10	0.60	10ND	
30	8" Round Grate	Gray	10	0.60	10ND	
30S	8" Round Grate	Sand	10	0.60	10ND	
 Fits Spee-D® Basin, 6" Sewer and Drain Pipe & Fittings and 6" Corrugated Pipe. (see page 74). ADA Compliant.						

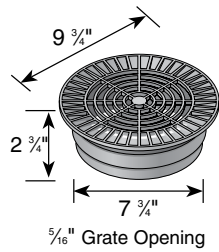

Part No.	Description	Color	Pkg. Qty.	Wt. Ea. lbs.	Product Class	Specifications
1040	10" Round Grate	Black	10	1.01	10ND	10" Round Structural Foam Polyolefin Grate with UV inhibitor. Open surface area 21.57 square inches. 65.99 GPM.
1050	10" Round Grate	Green	10	1.01	10ND	
1060	10" Round Grate	Gray	10	1.01	10ND	
1060S	10" Round Grate	Sand	10	1.01	10ND	
 Fits 8" Sewer and Drain Pipe & Fittings, 8" Corrugated Pipe. (see page 74). ADA Compliant.						

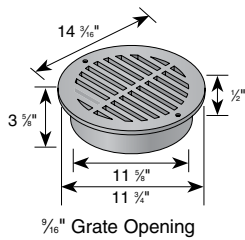

Part No.	Description	Color	Pkg. Qty.	Wt. Ea. lbs.	Product Class	Specifications
1240	12" Round Grate	Black	6	2.44	10ND	12" Round Structural Foam Polyolefin Grate with UV inhibitor. Open surface area 46.00 square inches. 140.72 GPM.
1250	12" Round Grate	Green	6	2.44	10ND	
1260	12" Round Grate	Gray	6	2.44	10ND	
 Fits 12" Sewer and Drain Pipe, 12" Corrugated Pipe. (see page 74).						

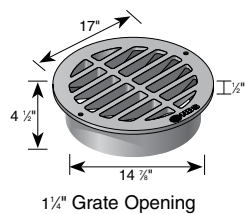

Part No.	Description	Color	Pkg. Qty.	Wt. Ea. lbs.	Product Class	Specifications
1511	15" Round Grate	Black	6	6.89	10ND	15" Round Structural Foam Polyolefin Grate with UV inhibitor. Open surface area 85.60 square inches. 261.86 GPM.
1512	15" Round Grate	Green	6	6.89	10ND	
 Fits 15" Sewer and Drain Fittings, 15" Corrugated Pipe. (see page 74).						

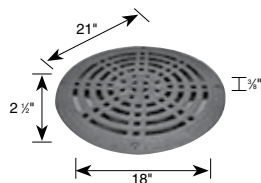

Part No.	Description	Color	Pkg. Qty.	Wt. Ea. lbs.	Product Class	Specifications
1801SDG	18" Round Grate	Green	1	7.50	28ND	Round Polypropylene Grate. Open surface area 75.55 square inches. 231.12 GPM. Includes lag bolts.
 Fits 18" Sewer and Drain Fittings, 18" Corrugated Pipe, includes Lag Bolts. (see page 74).						

## GRATES: STANDARD, DECORATIVE & METAL

### Atrium Grates

DRAINAGE

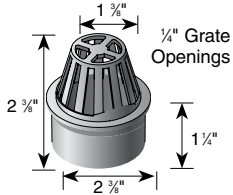

Part No.	Description	Color	Pkg. Qty.	Wt. Ea. lbs.	Product Class	Specifications
270	2" Atrium Grate	Gray	20	0.10	10ND	Flat-Top PVC Atrium Grate with UV inhibitor. Open surface area 4.00 square inches. 12.24 GPM.
Fits 2" Schedule 40 Fittings.						

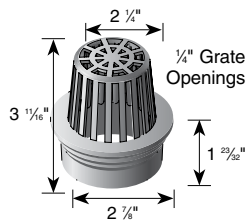

Part No.	Description	Color	Pkg. Qty.	Wt. Ea. lbs.	Product Class	Specifications
70	3" Atrium Grate	Green	20	0.16	10ND	Flat-Top Structural Foam Polyolefin Atrium Grate with UV inhibitor. Open surface area 9.40 square inches. 28.76 GPM.
72	3" Atrium Grate	Gray	20	0.16	10ND	
74	3" Atrium Grate	Black	20	0.16	10ND	
74S	3" Atrium Grate	Sand	20	0.16	10ND	
Fits 3" Sewer and Drain Pipe & Fittings, 3" Corrugated Pipe, and 3" Triple Wall Pipe.						

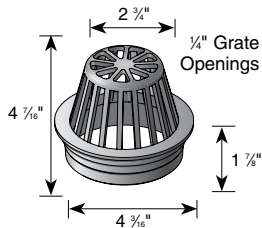

Part No.	Description	Color	Pkg. Qty.	Wt. Ea. lbs.	Product Class	Specifications
75	4" Atrium Grate	Green	20	0.21	10ND	Flat-Top Structural Foam Polyolefin Atrium Grate with UV inhibitor. Open surface area 17.00 square inches. 52.01 GPM.
76	4" Atrium Grate	Gray	20	0.21	10ND	
78	4" Atrium Grate	Black	20	0.21	10ND	
78S	4" Atrium Grate	Sand	20	0.21	10ND	
Fits 4" Sewer and Drain Pipe & Fittings, 4" Corrugated Pipe, and 4" Triple Wall Pipe.						

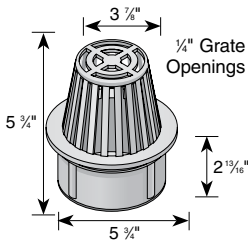

Part No.	Description	Color	Pkg. Qty.	Wt. Ea. lbs.	Product Class	Specifications
80	6" Atrium Grate	Green	10	0.62	10ND	Flat-Top Structural Foam Polyolefin Atrium Grate with UV inhibitor. Open surface area 28.40 square inches. 86.88 GPM.
81	6" Atrium Grate	Gray	10	0.62	10ND	
90	6" Atrium Grate	Black	10	0.62	10ND	
90S	6" Atrium Grate	Sand	10	0.62	10ND	
Fits Spee-D® Basin, 6" Sewer and Drain Pipe & Fittings, 6" Corrugated Pipe.						

# GRATES: STANDARD, DECORATIVE & METAL

## Square Grates

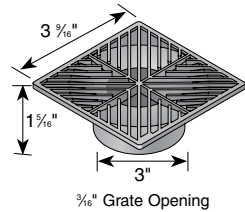

Part No.	Description	Color	Pkg. Qty.	Wt. Ea. lbs.	Product Class	Specifications
1	4" Square Grate	Green	40	0.11	10ND	4" Square Structural Foam Polyolefin Grate with diagonally converging pattern with UV inhibitor. Open surface area 3.45 square inches. 10.55 GPM.
2	4" Square Grate	Black	40	0.11	10ND	
3	4" Square Grate	Gray	40	0.11	10ND	
Fits 3" Sewer and Drain Pipe & Fittings, 3" Corrugated Pipe, and 3" Triple Wall Pipe. (see page 74). ADA Compliant/Heel-proof.						

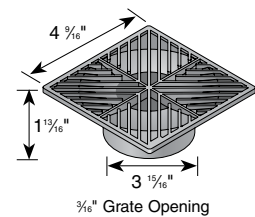

Part No.	Description	Color	Pkg. Qty.	Wt. Ea. lbs.	Product Class	Specifications
7	5" Square Grate	Green	25	0.20	10ND	5" Square Structural Foam Polyolefin Grate with diagonally converging pattern with UV inhibitor. Open surface area 4.25 square inches. 13.00 GPM.
8	5" Square Grate	Black	25	0.20	10ND	
9	5" Square Grate	Gray	25	0.20	10ND	
Fits 4" Sewer and Drain Pipe & Fittings, 4" Corrugated Pipe, and 4" Triple Wall Pipe. (see page 74). ADA Compliant/Heel-proof.						

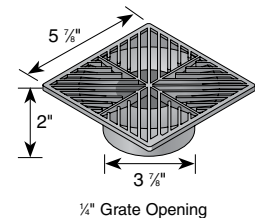

Part No.	Description	Color	Pkg. Qty.	Wt. Ea. lbs.	Product Class	Specifications
4	6" Square Grate	Black	10	0.40	10ND	6" Square Structural Foam Polyolefin Grate with diagonally converging pattern with UV inhibitor. Open surface area 10.40 square inches. 31.81 GPM.
5	6" Square Grate	Green	10	0.40	10ND	
6	6" Square Grate	Gray	10	0.40	10ND	
06S	6" Square Grate	Sand	10	0.40	10ND	
Fits 3" or 4" Sewer and Drain Pipe, 3" or 4" Corrugated Pipe, and 3" or 4" Triple Wall Pipe. (see page 74). ADA Compliant/Heel-proof.						

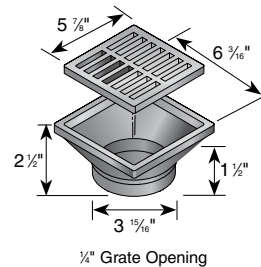

Part No.	Description	Color	Pkg. Qty.	Wt. Ea. lbs.	Product Class	Specifications
640	6" x 6" x 4" Square Grate & Adapter	Black	8	0.83	10ND	6"x6" Low-Profile Adapter and Structural Foam Polyolefin Removable Grate with UV inhibitor and stainless steel screws. Open surface area 14.44 square inches. 44.17 GPM.
641	6" x 6" x 4" Square Grate & Adapter	Green	8	0.83	10ND	
642	6" x 6" x 4" Square Grate & Adapter	Gray	8	0.83	10ND	
Fits 3" or 4" Sewer and Drain Pipe & Fittings, 3" or 4" Corrugated Pipe, and 3" or 4" Triple Wall Pipe. (see page 74). ADA Compliant/Heel-proof.						

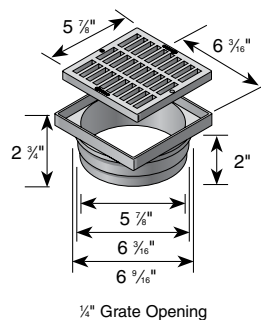

Part No.	Description	Color	Pkg. Qty.	Wt. Ea. lbs.	Product Class	Specifications
637	6" x 6" x 6" Square Grate & Adapter	Black	8	0.88	10ND	6"x6" Low-Profile Adapter and Structural Foam Polyolefin Removable Grate with UV inhibitor and stainless steel screws. Open surface area 14.44 square inches. 44.17 GPM.
639	6" x 6" x 6" Square Grate & Adapter	Gray	8	0.88	10ND	
Fits Spee-D® Basin, 6" Sewer and Drain Pipe & Fittings. (see page 74). ADA Compliant/Heel-proof.						

DRAINAGE

## GRATES: STANDARD, DECORATIVE & METAL / SPEE-D® BASINS

### Square Grates (continued)

DRAINAGE

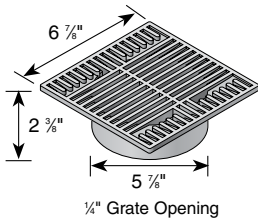

Part No.	Description	Color	Pkg. Qty.	Wt. Ea. lbs.	Product Class	Specifications
771	7" Square Grate	Black	10	0.65	10ND	7" Square Structural Foam Polyolefin Grate with UV inhibitor. Open surface area 13.60 square inches. 41.60 GPM.
772	7" Square Grate	Green	10	0.65	10ND	
773	7" Square Grate	Gray	10	0.65	10ND	
773S	7" Square Grate	Sand	10	0.65	10ND	
	 Fits Spee-D® Basin, 6" Sewer and Drain Pipe & Fittings, 6" Corrugated Pipe. (see page 74). ADA Compliant/Heel-proof.					

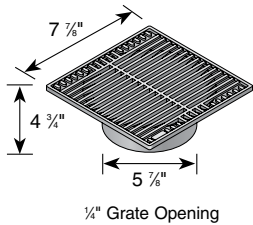

Part No.	Description	Color	Pkg. Qty.	Wt. Ea. lbs.	Product Class	Specifications
881	8" Square Grate	Black	10	0.79	10ND	8" Square Structural Foam Polyolefin Grate with UV inhibitor. Open surface area 17.16 square inches. 52.49 GPM.
882	8" Square Grate	Green	10	0.79	10ND	
883	8" Square Grate	Gray	10	0.79	10ND	
883S	8" Square Grate	Sand	10	0.79	10ND	
	 Fits Spee-D® Basin, 6" Sewer and Drain Pipe & Fittings, 6" Corrugated Pipe and DWV Pipe. (see page 74). ADA Compliant/Heel-proof.					

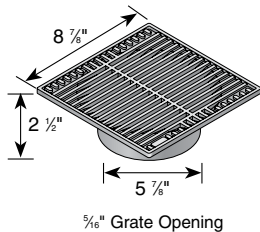

Part No.	Description	Color	Pkg. Qty.	Wt. Ea. lbs.	Product Class	Specifications
950	9" Square Grate	Green	10	1.11	10ND	9" Square Structural Foam Polyolefin Grate with UV inhibitor. Open surface area 28.40 square inches. 86.88 GPM.
960	9" Square Grate	Gray	10	1.11	10ND	
970	9" Square Grate	Black	10	1.11	10ND	
970S	9" Square Grate	Sand	10	1.11	10ND	
	 Fits Spee-D® Basin, 6" Sewer and Drain Pipe & Fittings, 6" Corrugated Pipe. (see page 74). ADA Compliant.					

## GRATES: STANDARD, DECORATIVE & METAL

### Duracast™ In-Line Grates

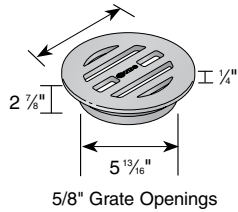

Part No.	Description	Color	Pkg. Qty.	Wt. Ea. (lbs.)	Product Class	Specifications
D6	6" Round Grate	Black	1	7.30	10ND	6" Round Heavy-Duty Ductile Grate with Black Paint. Open surface area 7.05 square inches. 21.57 GPM. H-20 load rating.
	 Fits 6" Corrugated and Sewer and Drain Pipe. D6 is not a custom grate and qualifies for normal NDS freight terms. Fits SPEE-D® Basin. (see page 74)					

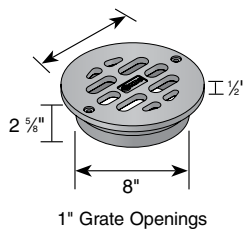

Part No.	Description	Color	Pkg. Qty.	Wt. Ea. (lbs.)	Product Class	Specifications
D8	8" Round Grate	Black	1	14.59	10ND	8" Round Heavy-Duty Ductile Iron Grate with Black Paint. Open surface area 13.98 square inches. 42.77 GPM. Bolt holes for added security. H-20 load rating.
	 Fits 8" Corrugated and Sewer and Drain Pipe. D8 is not a custom grate and qualifies for normal NDS freight terms. (see page 74)					

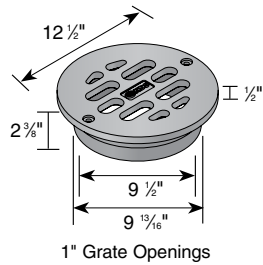

Part No.	Description	Color	Pkg. Qty.	Wt. Ea. (lbs.)	Product Class	Specifications
D10	10" Round Grate	Black	1	20.60	10ND	10" Round Heavy-Duty Ductile Iron Grate with Black Paint. Open surface area 26.82 square inches. 82.05 GPM. Bolt holes for added security. H-20 load rating.
	 Fits 10" Corrugated and Sewer and Drain Pipe. D10 is not a custom grate and qualifies for normal NDS freight terms. (see page 74)					

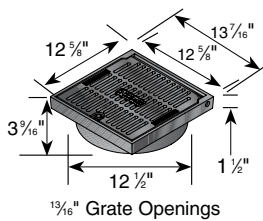

Part No.	Description	Color	Pkg. Qty.	Wt. Ea. (lbs.)	Product Class	Specifications
D12H-WO	12" Square Hinged Cast Iron Grate without Adapter	Black	1	48.00	10ND	H-20 load rating. Open surface area 48.30 square inches. 147.76 GPM.
D12	12" Round Grate	Black	1	16.00	10ND	H-20 load rating. Open surface area 55.16 square inches. 169.74 GPM.
	 Fits 12" Corrugated and Sewer and Drain Pipe. (see page 74)					

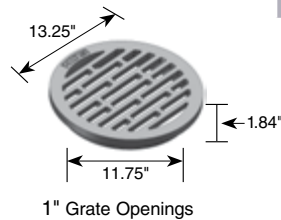

## CHANNEL AND TRENCH DRAINS



NDS Channel and Trench Drain Systems provide durable and proven solutions for sheet-flow drainage in applications ranging from light foot traffic to heavy vehicular traffic.

### Durable

Designed for maximum durability, drainage, and performance NDS Channel and Trench Drains are a proven alternative to traditional concrete drains. UV inhibitors in the plastic grate, channel and component parts prevent fading and cracking from the sun. All plastic grate and channel components are **chemically resistant, rustproof, and maintenance-free.**

### Simple

NDS Channel and Trench Drains are light weight and easy to install. Grates are removable for easy clean out and replacement. Grates may be held in place with screws or hold-down clips. A complete line of accessories is available for each Channel and Trench Drain System. Our "Profile Series" of channel drains connect like PVC pipe. Our "Modular Pro Series" Injection Molded Channel has mechanical interlocking joints. Our "Dura Slope" Trench Drain System is injection-molded, modular, has mechanical interlocking joints and a built-in slope. All NDS Channel and Trench Drain Systems easily connect to sewer and drain pipes and fittings or Sch. 40 pipes and fittings.

### Versatile

To blend with surrounding surfaces, our plastic Channel Grates are available in six colors, some with decoactive options, as well as solid brass for the Mini Channel. Cast iron and rolled steel grates are available for the Dura Slope and Pro Series Channel. A ductile iron frame is also available. NDS Channel and Trench Drains also offer a choice of outletting locations; bottom, end and side options available.

### Efficient

Channel and Trench Drains eliminate the need for grading a deck surface to a low area. Instead, the deck is gradually sloped in one direction or plane, and the channel drain acts as a perimeter drain at the edge of the slope to receive sheet-flow runoff. Channel and Trench Drain Systems provide more overall open surface area than conventional area grates.

### Recommended Applications

- Driveways
- Warehouses
- Washdown Areas
- Loading Docks
- Tennis Courts
- Patios
- Nurseries & Greenhouses
- Plazas
- Parking Lots
- Swimming Pools & Spas
- Running Tracks
- Courtyards
- Sidewalks
- Sports Facilities
- Manufacturing Facilities
- Landings

See capacity recommendations for channel & trench drains, page 74.



## DURA SLOPE™ TRENCH DRAIN – PRE-SLOPED (PATENTED)



NDS Dura Slope™ is a high-quality quality, dependable, best-in-class trench drain system ideal for a variety of drainage solutions, including driveways, parking areas, warehouses, loading docks, pools, wash down areas and other areas for the interception and collection of surface runoff. Dura Slope™ pre-sloped and neutral trench drain system provides a solution for residential, commercial, industrial and municipal drainage needs.

DRAINAGE

The NDS Dura Slope™ trench drain system consists of 33 channel sections; 24 pre-sloped sections with 0.7% built in slope and 9 neutral sections. The system also has a catch basin assembly. All Dura Slope™ channel sections are 48" long, grip #3 and #4 rebar and support 6" wide grates. Dura Slope™ channel sections are also available in depths from 4" to 12".

The sloped channel sections enable the Dura Slope™ system to extend to a length of 96 feet with continuous slope. The neutral channel sections can be used for non-sloped system runs or can be used in conjunction with the pre-sloped channel sections for an extended system run of 132 feet. By incorporating central collection using the catch basin assembly, the Dura Slope™ trench drain system can be extended up to 266 feet. The ProFit™ locking system maintains structural integrity during installation, and is a locking device and support for the grates. Each channel section ships with ProFit™, Blank Grate Inserts and grate screws installed.

### Details

- Lightweight 4 ft. modular sections
- Easier handling and installation
- Lower freight costs
- 2" radius bottom minimizes debris build-up
- Polyethylene material
- Durable and inexpensive
- Less breakage versus concrete
- High chemical resistance
- Bottom outlet on each channel section
- System versatility
- Requires fewer accessories
- 0.7% built-in slope
- Maintains optimum flow rates throughout system

# DURA SLOPE™ TRENCH DRAIN – PRE-SLOPED (PATENTED)

## Product Features & Benefits

DRAINAGE

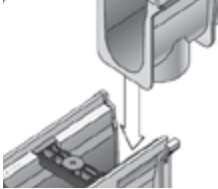

### Interlocking tongue and groove joints

- Secures alignment
- Ensures straight channel runs
- Easy assembly and installation

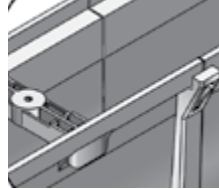

### DuraLoc™ integral joint lock

- Prevents joint movement during installation
- No extra clamps or screws needed

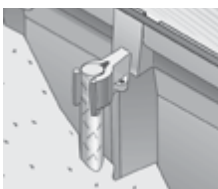
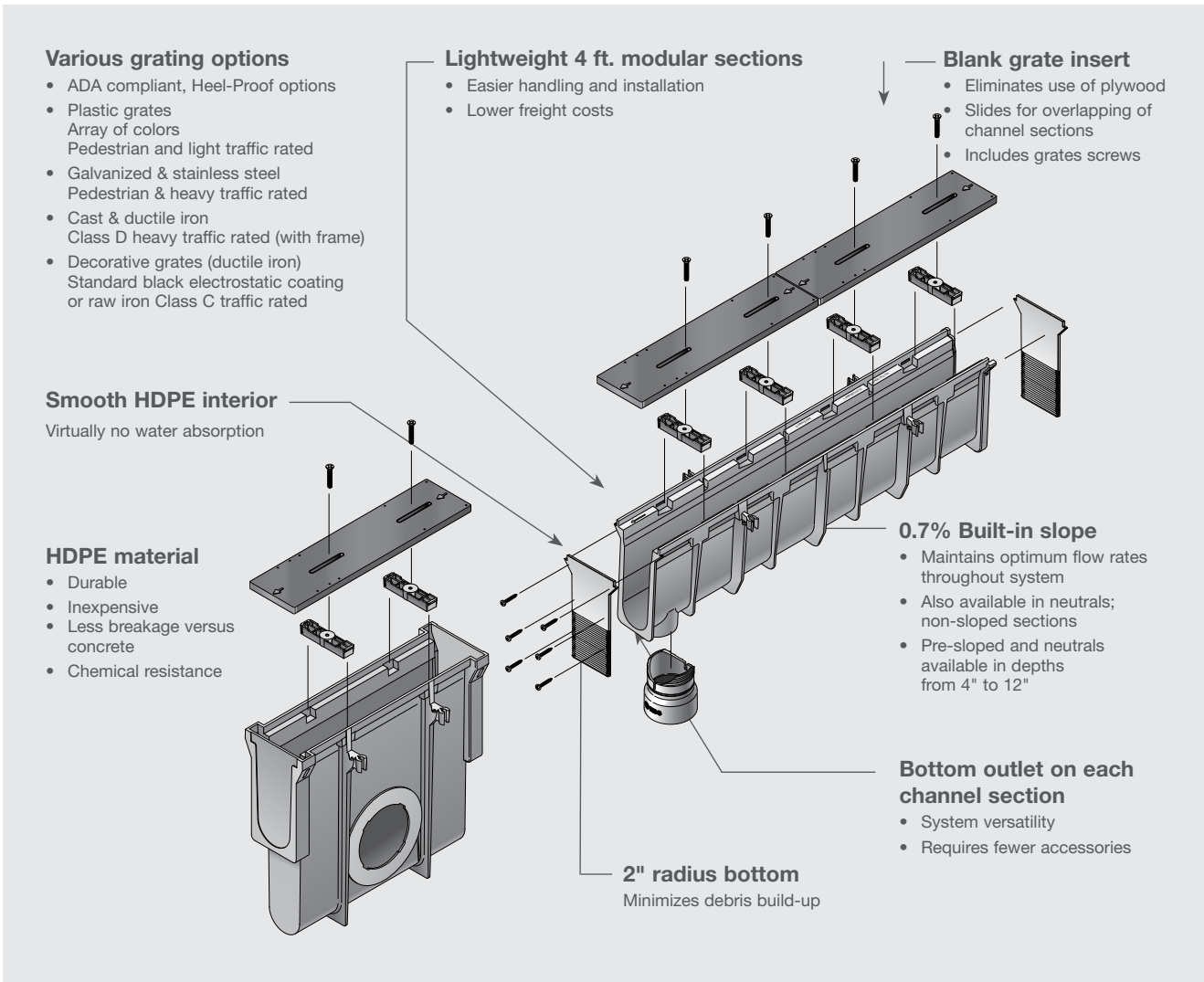

### Leveloc™ re-bar supports with integral protruding knob

- Levels channel and grips re-bar
- Requires fewer accessories

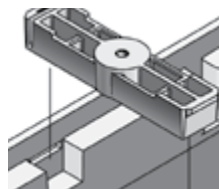

### ProFit™ locking system

- Locks grate to integral frame
- Supports product in shipping and installation (included)

## DURA SLOPE™ TRENCH DRAIN – PRE-SLOPED

### Dura Slope™ Channel Drain Sections

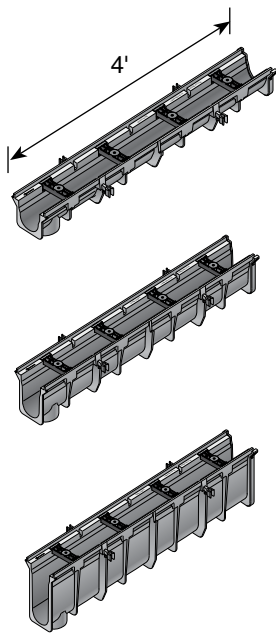

Part No.	Description	Color	Pkg. Qty.	Wt. Ea. (lbs.)	Product Class
DS-090N	3.99" Deep Neutral Dura Slope Channel	Light Gray	1	7.45	25DS
DS-091	3.99" to 4.34" Deep Dura Slope Channel	Light Gray	1	7.52	25DS
DS-091N	4.34" Deep Neutral Dura Slope Channel	Light Gray	1	7.81	25DS
DS-092	4.34" to 4.67" Deep Dura Slope Channel	Light Gray	1	7.92	25DS
DS-093	4.67" to 5.00" Deep Dura Slope Channel	Light Gray	1	8.27	25DS
DS-094	5.00" to 5.34" Deep Dura Slope Channel	Light Gray	1	8.64	25DS
DS-094N	5.34" Deep Dura Slope Channel	Light Gray	1	8.93	25DS
DS-095	5.34" to 5.68" Deep Dura Slope Channel	Light Gray	1	8.99	25DS
DS-096	5.68" to 6.01" Deep Dura Slope Channel	Light Gray	1	9.36	25DS
DS-097	6.01" to 6.35" Deep Dura Slope Channel	Light Gray	1	9.74	25DS
DS-097N	6.35" Deep Neutral Dura Slope Channel	Light Gray	1	10.04	25DS
DS-098	6.35" to 6.69" Deep Dura Slope Channel	Light Gray	1	10.11	25DS
DS-099	6.69" to 7.02" Deep Dura Slope Channel	Light Gray	1	10.48	25DS
DS-100	7.02" to 7.36" Deep Dura Slope Channel	Light Gray	1	10.86	25DS
DS-100N	7.36" Deep Neutral Dura Slope Channel	Light Gray	1	11.16	25DS
DS-101	7.36" to 7.69" Deep Dura Slope Channel	Light Gray	1	11.23	25DS
DS-102	7.69" to 8.03" Deep Dura Slope Channel	Light Gray	1	11.60	25DS
DS-103	8.03" to 8.37" Deep Dura Slope Channel	Light Gray	1	11.98	25DS
DS-103N	8.37" Deep Neutral Dura Slope Channel	Light Gray	1	12.27	25DS
DS-104	8.37" to 8.70" Deep Dura Slope Channel	Light Gray	1	12.34	25DS
DS-105	8.70" to 9.04" Deep Dura Slope Channel	Light Gray	1	12.71	25DS
DS-106	9.04" to 9.37" Deep Dura Slope Channel	Light Gray	1	13.07	25DS
DS-106N	9.37" Deep Neutral Dura Slope Channel	Light Gray	1	13.39	25DS
DS-107	9.37" to 9.70" Deep Dura Slope Channel	Light Gray	1	13.40	25DS
DS-108	9.70" to 10.05" Deep Dura Slope Channel	Light Gray	1	13.83	25DS
DS-109	10.05" to 10.38" Deep Dura Slope Channel	Light Gray	1	14.20	25DS
DS-109N	10.38" Deep Neutral Dura Slope Channel	Light Gray	1	14.50	25DS
DS-110	10.38" to 10.71" Deep Dura Slope Channel	Light Gray	1	14.57	25DS
DS-111	10.71" to 11.05" Deep Dura Slope Channel	Light Gray	1	14.95	25DS
DS-112	11.05" to 11.39" Deep Dura Slope Channel	Light Gray	1	15.32	25DS
DS-112N	11.39" Deep Neutral Dura Slope Channel	Light Gray	1	15.60	25DS
DS-113	11.39" to 11.72" Deep Dura Slope Channel	Light Gray	1	15.69	25DS
DS-114	11.72" to 12.06" Deep Dura Slope Channel	Light Gray	1	16.06	25DS

DRAINAGE

## DURA SLOPE™ TRENCH DRAIN – PRE-SLOPED

### Standard Grates

DRAINAGE

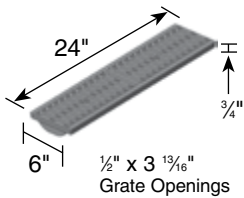

Part No.	Description	Color	Pkg. Qty.	Wt. Ea. (lbs.)	Product Class	Specifications
660	2 ft. Channel Grate	White	24 ft.	2.82	25DS	2 ft. Structural Foam Polyolefin, secured Channel Grate with UV inhibitor. Open surface area 25.40 square inches per foot. 77.70 GPM per foot.
661	2 ft. Channel Grate	Dark Gray	24 ft.	2.82	25DS	
661LG	2 ft. Channel Grate	Light Gray	24 ft.	2.82	25DS	
662	2 ft. Channel Grate	Green	24 ft.	2.82	25DS	
663	2 ft. Channel Grate	Black	24 ft.	2.82	25DS	
664	2 ft. Channel Grate	Sand	24 ft.	2.82	25DS	
665	2 ft. Channel Grate	Brick Red	24 ft.	2.82	25DS	
 Use with Dura Slope Drains (page 51), Dura Slope Catch Basins (page 53). (see page 74). ADA Compliant.						

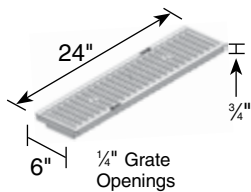

Part No.	Description	Color	Pkg. Qty.	Wt. Ea. (lbs.)	Product Class	Specifications
DS-670	2 ft. Plastic Perforated Channel Grate	Light Gray	24 ft.	2.81	25DS	2 ft. Structural Foam Polyolefin, secured Channel Grate with UV inhibitor, light traffic rated, heelproof, ADA compliant. Open surface area 8.75 square inches per foot. 26.77 GPM per foot.
DS-671	2 ft. Plastic Perforated Channel Grate	White	24 ft.	2.81	25DS	
 Use with Dura Slope Drains (page 51), Dura Slope Catch Basins (page 53). (see page 74). ADA Compliant/Heelproof.						

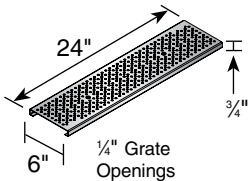

Part No.	Description	Color	Pkg. Qty.	Wt. Ea. (lbs.)	Product Class	Specifications
DS-226	2 ft. Stainless Steel Perforated Channel Grate	Steel	24 ft.	3.16	25DS	Perforated Metal Grate, pedestrian traffic rated, heelproof, ADA compliant. Open surface area 7.63 square inches per foot. 23.34 GPM per foot.
DS-228	2 ft. Galvanized Steel Perforated Channel Grate	Steel	24 ft.	3.83	25DS	
 Use with Dura Slope Drains (page 51), Dura Slope Catch Basins (page 53). (see page 74). ADA Compliant/Heelproof.						

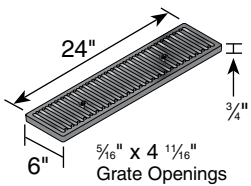

Part No.	Description	Color	Pkg. Qty.	Wt. Ea. (lbs.)	Product Class	Specifications
DS-231	2 ft. Cast Iron Channel Grate	Black	1	18.90	25DS	2 ft. heavy-duty Iron Channel Grate. Open surface area 20.85 square inches per foot. 63.78 GPM per foot. H-20 load rating.
DS-232	2 ft. Ductile Iron	Black	1	15.20	25DS	
 Use with Dura Slope Drains (page 51), Dura Slope Catch Basins (page 53). (see page 74). ADA Compliant. Must be used with DS-200H to achieve Class D Load Rating.						

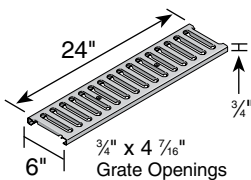

Part No.	Description	Color	Pkg. Qty.	Wt. Ea. (lbs.)	Product Class	Specifications
DS-221	2 ft. Galvanized Steel Channel Grate	Steel	24 ft.	6.64	25DS	2 ft. Galvanized Rolled Steel Grate. Open surface area 23.09 square inches per foot. 70.64 GPM per foot.
 Use with Dura Slope Drains (page 51), Dura Slope Catch Basins (page 53). Includes bracket to attach grate to channel and screws. (see page 74)						

## DURA SLOPE™ TRENCH DRAIN – PRE-SLOPED

### Decorative Grates

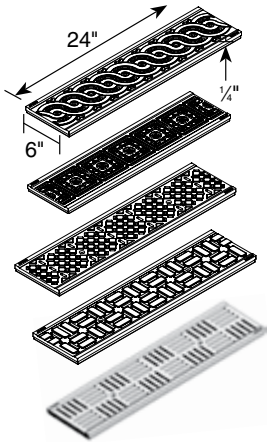

Part No.	Description	Color	Pkg. Qty.	Wt. Ea. (lbs.)	Product Class	Specifications
DS-601	Weave Pattern	Raw Iron	1	14.50	25DS	Decorative grates are made of ductile iron. <b>Weave:</b> open area 6.75 square inches per foot; 20.65 GPM. <b>Diamond:</b> open area 9.55 square inches per foot; 29.21 GPM. <b>Tile:</b> open area 7.95 square inches per foot; 24.32 GPM. <b>Brick:</b> open area 11.35 square inches per foot; 34.725 GPM. <b>Deco slot:</b> open area 16.75 square inches per foot; 51.24 GPM.
DS-602	Diamond Pattern	Raw Iron	1	14.30	25DS	
DS-603	Tile Pattern	Raw Iron	1	14.70	25DS	
DS-604	Brick Pattern	Raw Iron	1	14.30	25DS	
DS-609	Deco Slot	Raw Iron	1	14.50	25DS	
<p>Use with Dura Slope Drains (page 51), Dura Slope Catch Basins (see below).</p> <p>Decorative grates are made of ductile iron. Uncoated raw iron will develop a rust patina over time. Additional powder-coat colors available: Black (K), White (W), Silver (S), Bronze (Z), Green (G), Blue (B), Orange (O), Gray (Y), Brown (N)</p> <p>MTO 6-7 week lead time.</p> <p>(see page 74). ADA Compliant/Heel-proof. Must be used with DS-200H to achieve Class D Load Rating.</p>						

DRAINAGE

### In-Line Catch Basin

The NDS Dura Slope™ in-line catch basin is designed to fit all depth ranges of the Dura Slope™ trench drain sections. Catch basin inlets are designed to be sized as required to accept the Dura Slope™ trench drain section. The Dura Slope™ catch basin is 2 feet long and 2 feet deep with an outlet on both sides of the basin. One Universal Adapter Plug, one blank grate insert and two grate screws are included with each Dura Slope™ in-line catch basin. The NDS universal basin outlets are used to adapt the catch basin to 3", 4", 6" and 8" pipe.

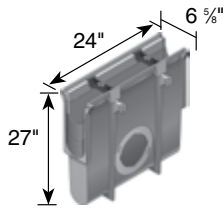

Part No.	Description	Color	Pkg. Qty.	Wt. Ea. (lbs.)	Product Class
DS-340	Dura Slope™ In-Line Catch Basins	Light Gray	1	12.00	25DS
<p>Available for use of one or two outlets. Use #1242, #1243, #1245, #1266, #1206 or #1888 Universal Outlets (see pages 32-33).</p>					

### Trash Bucket

Dura Slope™ Trash Bucket is made to fit inside the Dura Slope™ Catch Basin (part number DS-340). It has a handle for easy removal to clean leaves and debris; it requires removal of the grate. Made of zinc plated steel, it is durable to climatic conditions. The Trash Bucket is not intended for use with any of the Dura Slope™ Channels. *Note: DS-240 Trash Bucket is not for use with the DS-200H Ductile Iron Frame.*

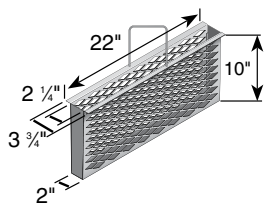

Part No.	Description	Color	Pkg. Qty.	Wt. Ea. (lbs.)	Product Class
DS-240	Dura Slope™ Trash Bucket	Steel Zinc-Plated Steel	1	5.00	25DS

# DURA SLOPE™ TRENCH DRAIN – PRE-SLOPED

## Accessories

DRAINAGE

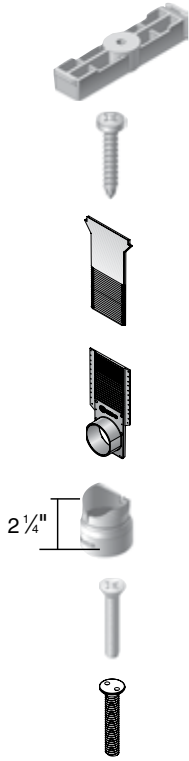

Part No.	Description	Color	Pkg. Qty.	Wt. Ea. (lbs.)	Product Class
DS-122	ProFit™ Grate Lock	Black	8	0.80	25DS
DS-123	Dura Slope Frame & End Cap Screws PH. #6	Steel	12		25DS
	Use on DS-124 Universal End Cap & DS-127 x 3/4". Universal End Outlet downstream for (male) end. Use to attach DS-200 DI Frame to Channel.				
DS-224	Universal End Cap	Gray	8	0.63	25DS
	Replaces DS-124, which will not work with DS-113 or deeper channels. Slides into upstream (female) end. Requires DS-123 screws on downstream (male) end.				
DS-227	Universal End Outlet	Gray	6	0.75	25DS
	Replaces DS-127, which will not work with DS-113 or deeper channels. Requires DS-123 screws for use on downstream (male) end. Fits to 4" S&D Pipe.				
DS-126	Bottom Outlet Adapter	Gray	6	0.53	25DS
	Fits to 4" S&D Pipe. DS-126 not required for Sch. 40 connection.				
629	Grate Screws FH # 1/4 - 20 x 1-1/2"	Steel	40	0.70	25PF
	Use with Grate # DS-231, DS-232, DS-670, DS-226 and 660-665. Use to secure grates in applications without DS-200 DI Frame				
DS-650	Flat Drilled Spanner End Cap Screws #6, 3/4"	Steel	12	1	25DS
	Drill bit included with each package.				

## Ductile Iron Frame

Dura Slope Ductile Iron Frame provides a Class D load rating of 326-575 psi and is suitable for heavy-duty hard tire equipment at speeds less than 20 mph. The DS-200H Ductile Iron Frame is recommended for use with pneumatic tire traffic such as fork lifts. The ductile iron frame can be used with the cast and ductile iron grates. *Note: DS-123 screws must be ordered to secure frame to the channel.*

Part No.	Description	Color	Pkg. Qty.	Wt. Ea. (lbs.)	Product Class
DS-200H	Dura Slope™ Ductile Iron Frame	Black	2 ft.	7.50	25DS
	Use with Dura Slope Drains (page 51), Dura Slope Catch Basins (page 53). To be used with DS-231 or DS-232 grates. New Feature: 1/4" Brass Nuts to secure channel inserted. (see page 74). ADA Compliant/Heel-proof when used with DS-231 or DS-232 grates.				

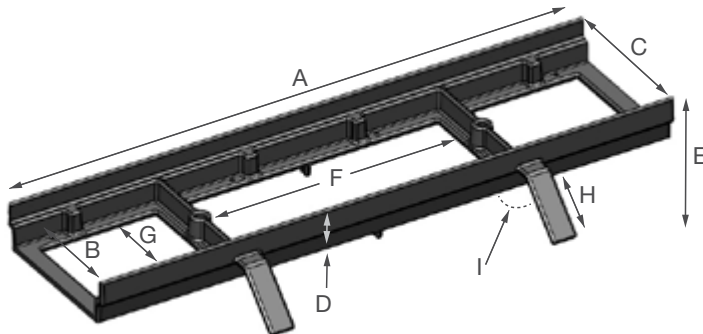

Dimension Key		
A	Length	24"
B	Inner Width	6"
C	Outer Width	6 3/8"
D	Added Profile	1" Height
E	Total Height	2 3/4"
F	Opening Length	10 3/4"
G	Opening Width	4 1/2"
H	Length of Anchor	2 5/8"
I	Angle of Anchor	30°

## DURA SLOPE™ TRENCH DRAIN – PRE-SLOPED

### EZ-Track™ Radius Coupling & Grates

Patent Pending

Designed specifically for draining 400-meter running tracks, Dura Slope™ Radius Couplings allow 3 degrees of deflection between trench drain sections, making an adjustable radius easily achievable for standard tracks and other curving applications.



DRAINAGE

### Details

- 80'-120' radius
- Heavy-duty HDPE trench drain
- No Special tools required components snap into place
- Four depths available
- Grate options: standard & slotted
- Flexible radius coupling (patent pending)

### Flexible Radius Coupling

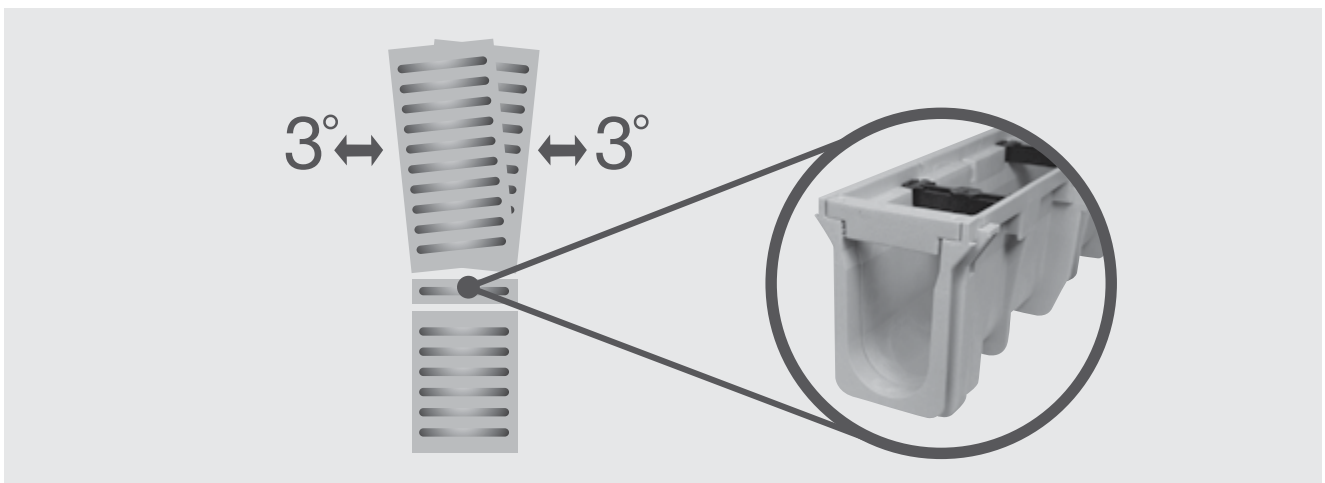

## DURA SLOPE™ TRENCH DRAIN – PRE-SLOPED

### EZ-Track™ Radius Coupling & Grates

DRAINAGE



Part No.	Description	Color	Pkg. Qty.	Wt. Ea. (lbs.)	Product Class	Specifications
DSRC-097	6.35" Deep Neutral Dura Slope™ Radius Coupling	Light Gray	6	0.81	25DS	3 degree max. deflection per coupling. Minimum inside radius of 26".
DSRC-100	7.36" Deep Neutral Dura Slope™ Radius Coupling	Light Gray	6	0.82	25DS	
DSRC-103	8.37" Deep Neutral Dura Slope™ Radius Coupling	Light Gray	6	0.83	25DS	
DSRC-106	9.37" Deep Neutral Dura Slope™ Radius Coupling	Light Gray	6	0.84	25DS	



Part No.	Description	Color	Pkg. Qty.	Wt. Ea. (lbs.)	Product Class	Specifications
DS-660MG	1.25" Plastic Slotted Radius Coupling Grate	White	6	0.15	25DS	Structural Foam Polyolefin Radius Coupling Channel Grate with UV inhibitor. Open surface area 1.88 square inches per grate. 5.75 GPM per grate.
DS-661MG	1.25" Plastic Slotted Radius Coupling Grate	Dark Gray	6	0.15	25DS	
DS-661LGMG	1.25" Plastic Slotted Radius Coupling Grate	Light Gray	6	0.15	25DS	
DS-662MG	1.25" Plastic Slotted Radius Coupling Grate	Green	6	0.15	25DS	
DS-663MG	1.25" Plastic Slotted Radius Coupling Grate	Black	6	0.15	25DS	
DS-664MG	1.25" Plastic Slotted Radius Coupling Grate	Sand	6	0.15	25DS	
DS-665MG	1.25" Plastic Slotted Radius Coupling Grate	Brick Red	6	0.15	25DS	



Part No.	Description	Color	Pkg. Qty.	Wt. Ea. (lbs.)	Product Class	Specifications
DS-681LGMG	1.25" Plastic Standard Radius Coupling Grate (no slot)	Light Gray	6	0.16	25DS	Solid Structural Foam Polyolefin Radius Coupling Channel Grate with UV inhibitor.



Part No.	Description	Color	Pkg. Qty.	Wt. Ea. (lbs.)	Product Class	Specifications
DS-232MG	1.25" Ductile Iron Radius Coupling Grate	Black	6	0.93	25DS	Ductile Iron Radius Coupling Channel Grate. Open surface area 1.88 square inches per grate. 5.75 GPM per grate.



Part No.	Description	Color	Pkg. Qty.	Wt. Ea. (lbs.)	Product Class	Specifications
DS-226MG	1.25" Perforated Stainless Steel Radius Coupling Grate	Steel	6	0.25	25DS	Stainless Steel Radius Coupling Channel Grate. Open surface area 0.86 square inches per grate. 2.63 GPM per grate.



Part No.	Description	Color	Pkg. Qty.	Wt. Ea. (lbs.)	Product Class	Specifications
DS-221MG	1.25" Galvanized Steel Radius Coupling Grate	Steel	6	0.33	25DS	Galvanized Steel Coupling Channel Grate. Open surface area 1.31 square inches per grate. 4.01 GPM per grate.



# DURA SLOPE™ TRENCH DRAIN – PRE-SLOPED

## Dura Slope™ System Profiles

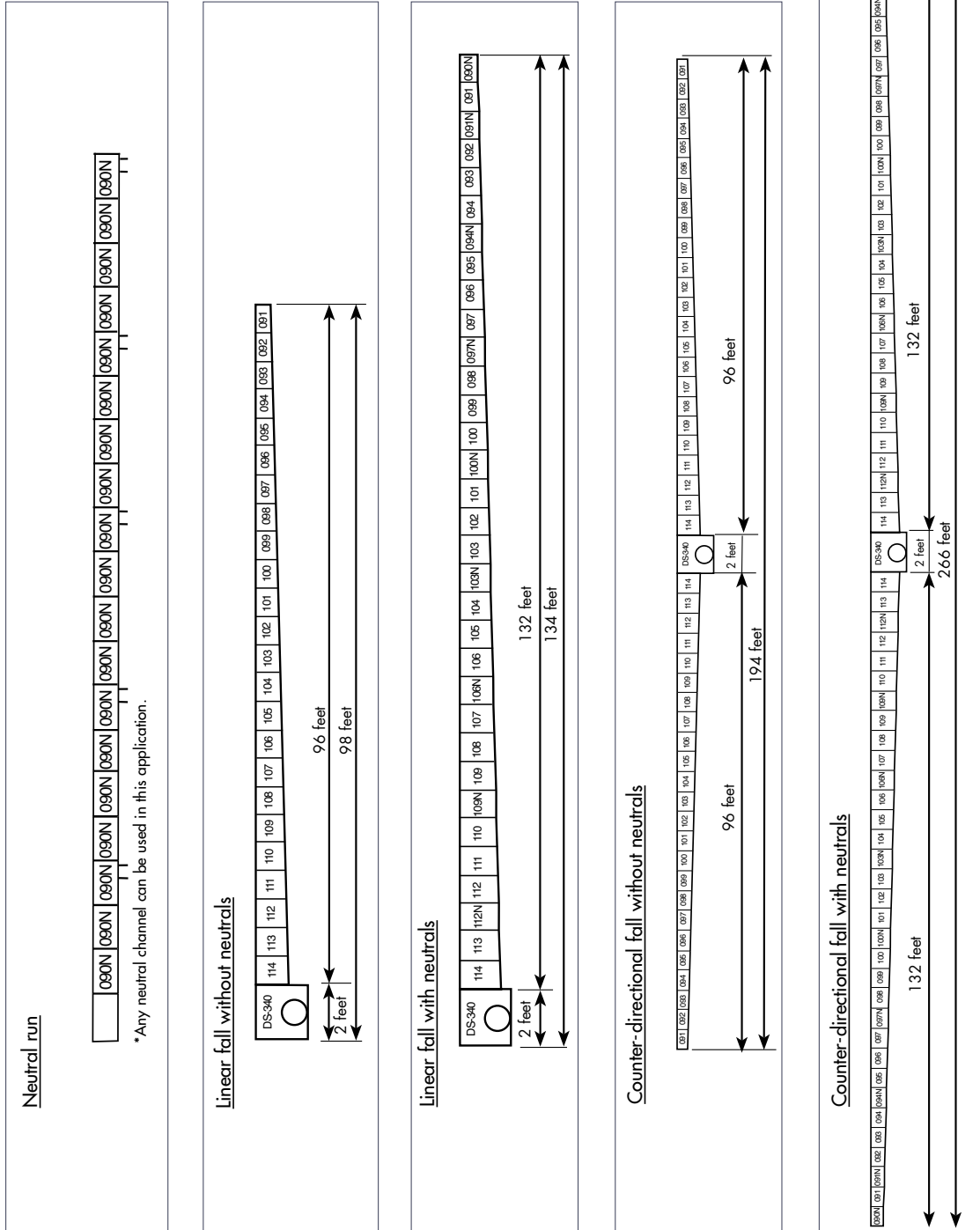

Note: Drawings are not to scale. See previous pages for actual product dimensions.

## PROFILE CHANNEL DRAINS

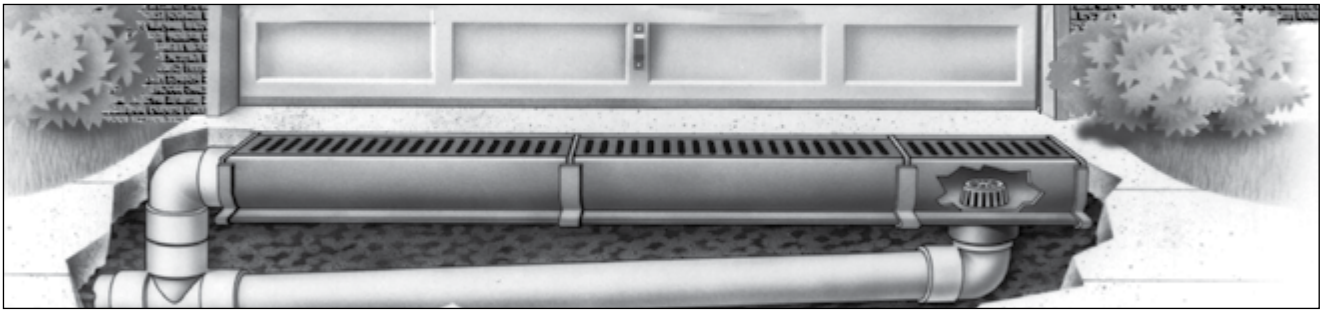

### Details

Unique patented flying buttress design provides load-bearing support from both sides as well as underneath.

Available in three sizes: Spee-D® for driveways, large decks and commercial areas; Mini for landscapes, pools or decks; and Micro for residential pools and spas.

Unique flanges on the bottom of the channel provide an anchoring lip for straight installation and prevents floating.

### Materials and Standards

Only channels made of PVC can be cut to any length and solvent-welded like PVC pipe.

Grates available in six colors with decorative options – see individual products for details.

Mini Channel Grate also available in solid brass.

Channel system offers choice of bottom, end or side outlets.

Concrete is not required under some channels for light vehicular applications. Standards vary per product.

### Mini and Spee-D® Channel System Components

1. Channel
2. Grate
3. Coupling
4. End Cap or End Outlet
5. Channel Bottom Outlet
6. Sewer and Drain Fitting
7. Drain Pipe

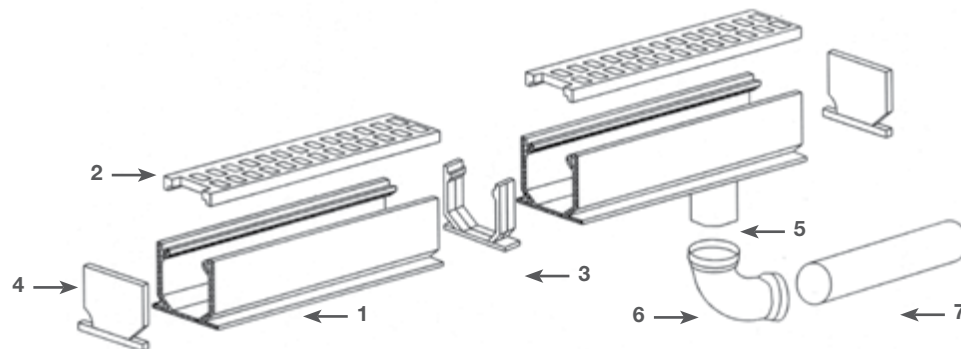

## PROFILE CHANNEL DRAINS

### Micro Channel™ Drains

Excellent performance at lowest possible cost. Designed for residential applications including swimming pools, spas and patios. Unique design features grate openings parallel to channel length and recessed grate for strength and effective runoff capture.

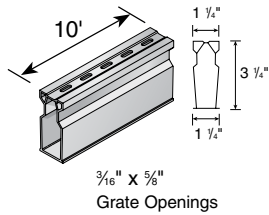

Part No.	Description	Color	Pkg. Qty.	Wt. Ea. (lbs.)	Product Class	Specifications
8001	10' Long Micro Channel	White	100 ft.	5.00	25PF	10 ft. Micro Channel with Recessed Reinforced Grate Area, Parallel Drain Slots with UV inhibitor. Open surface area 1.00 square inch per linear foot. 3.06 GPM per foot. PVC.
8002	10' Long Micro Channel	Sand	100 ft.	5.00	25PF	
8003	10' Long Micro Channel	Gray	100 ft.	5.00	25PF	
Includes 1 coupling. (see page 74). ADA Compliant/Heel-proof.						

### Micro Accessories

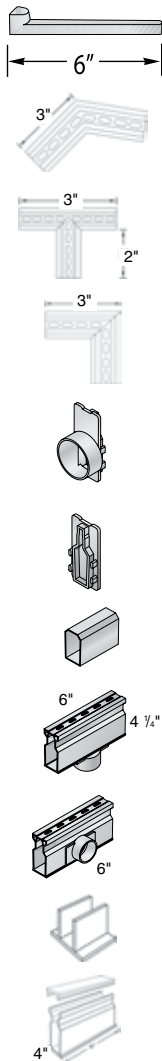

Part No.	Description	Color	Pkg. Qty.	Wt. Ea. (lbs.)	Product Class
230	6" Channel Installation Stake	Gray	24	0.04	25PF
8301	Micro Channel 45° Elbow	White	5	0.30	25PF
8302	Micro Channel 45° Elbow	Sand	5	0.30	25PF
8303	Micro Channel 45° Elbow	Gray	5	0.30	25PF
8371	Micro Channel Tee	White	5	0.40	25PF
8372	Micro Channel Tee	Sand	5	0.40	25PF
8373	Micro Channel Tee	Gray	5	0.40	25PF
8381	Micro Channel 90° Elbow	White	5	0.40	25PF
8382	Micro Channel 90° Elbow	Sand	5	0.40	25PF
8383	Micro Channel 90° Elbow	Gray	5	0.40	25PF
8461	Micro 1 1/2" Sch. 40 Spigot End Outlet	White	10	0.10	25PF
8462	Micro 1 1/2" Sch. 40 Spigot End Outlet	Sand	10	0.10	25PF
8463	Micro 1 1/2" Sch. 40 Spigot End Outlet	Gray	10	0.10	25PF
8471	Micro End Plug	White	20	0.05	25PF
8472	Micro End Plug	Sand	20	0.05	25PF
8473	Micro End Plug	Gray	20	0.05	25PF
8481	Micro Channel Couplings only Fits inside channel	White	20	0.10	25PF
8501	Micro 1 1/2" Sch. 40 Spigot Bottom Outlet	White	10	0.35	25PF
8502	Micro 1 1/2" Sch. 40 Spigot Bottom Outlet	Sand	10	0.35	25PF
8503	Micro 1 1/2" Sch. 40 Spigot Bottom Outlet	Gray	10	0.35	25PF
8511	Micro 1 1/2" Sch. 40 Spigot Side Outlet	White	10	0.35	25PF
8512	Micro 1 1/2" Sch. 40 Spigot Side Outlet	Sand	10	0.35	25PF
8513	Micro 1 1/2" Sch. 40 Spigot Side Outlet	Gray	10	0.35	25PF
8601	Micro Hold-Down Clips Use with Channel Stakes to hold channel in place	White	20	0.10	25PF
8651	Micro Channel Cleanout	White	10	0.30	25PF
8652	Micro Channel Cleanout	Sand	10	0.30	25PF
8653	Micro Channel Cleanout	Gray	10	0.30	25PF

# PROFILE CHANNEL DRAINS

## Mini Channel™ Drains

Excellent for light-duty applications including residential pools, concrete and paver patios, spas and tennis courts.

DRAINAGE

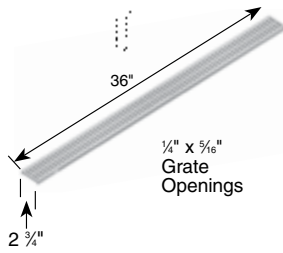

Part No.	Description	Color	Pkg. Qty.	Wt. Ea. (lbs.)	Product Class	Specifications
529	Stainless Steel Screws, FH #4 x 5/8"	Steel	64	0.10	25PF	3 ft. Structural Foam Polyolefin Channel Grate with UV inhibitor. Open surface area 9.90 square inches per foot. 30.29 GPM per foot.
540	3' Channel Grate	White	48 ft.	0.66	25PF	
541	3' Channel Grate	Gray	48 ft.	0.66	25PF	
542	3' Channel Grate	Green	48 ft.	0.66	25PF	
543	3' Channel Grate	Black	48 ft.	0.66	25PF	
544	3' Channel Grate	Sand	48 ft.	0.66	25PF	
551	3' Channel Grate	Brick Red	48 ft.	0.66	25PF	
Requires 4 screws per Grate. (see page 74). ADA Compliant/Heel-proof.						

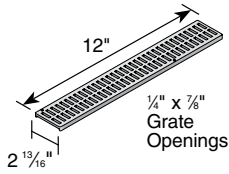

Part No.	Description	Color	Pkg. Qty.	Wt. Ea. (lbs.)	Product Class	Specifications
552B	1' Brass Channel Grate	Satin Brass	12	1.25	25PF	1 ft. Mini Channel Solid Brass Grate with brass screws. Open surface area 9.20 square inches per foot. 28.14 GPM per foot.
553PB	1' Brass Channel Grate	Polished Brass	12	1.25	25PF	
Fits #500 Mini Channel. (see page 74). ADA Compliant/Heel-proof.						

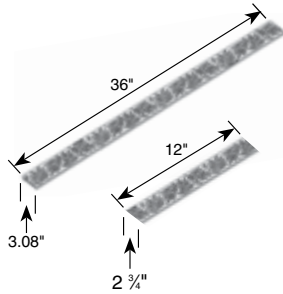

Part No.	Description	Color	Pkg. Qty.	Wt. Ea. (lbs.)	Product Class	Specifications
846	Stainless Steel Screws, FH #4 x 1"	Steel	64	0.10	25PF	3 ft. Structural Foam Polyolefin botanical pattern Channel Grate with UV inhibitor. Open surface area 5.44 square inches per foot. 16.64 GPM per foot.
554S	3' Botanical Channel Grate	Sand	16	0.89		
554GR	3' Botanical Channel Grate	Green	16	0.89		
554GY	3' Botanical Channel Grate	Gray	16	0.89		
554	3' Botanical Channel Grate	Black	16	0.89		1 ft. Mini Channel botanical Cast Iron Channel Grate. Open surface area 5.39 square inches per foot. 16.49 GPM per foot. Class B load rated.
554CI	1' Botanical Cast Iron Channel Grate	Raw Iron	1	1.82	10ND	
629	Stainless Steel Screws, FH #20 x 1-1/2"	Metal	40	n/a	10ND	
Fits #500 Mini Channel. (see page 74). ADA Compliant.						

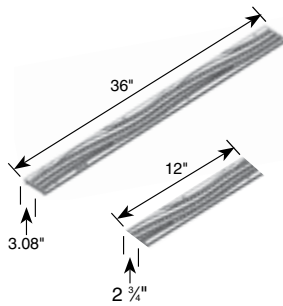

Part No.	Description	Color	Pkg. Qty.	Wt. Ea. (lbs.)	Product Class	Specifications
846	Stainless Steel Screws, FH #4 x 5/8"	Steel	64	0.10	25PF	3 ft. Structural Foam Polyolefin wave pattern Channel Grate with UV inhibitor. Open surface area 5.73 square inches per foot. 17.54 GPM per foot.
555S	3' Wave Channel Grate	Sand	16	0.88		
555GR	3' Wave Channel Grate	Green	16	0.88		
555GY	3' Wave Channel Grate	Gray	16	0.88		
555	3' Wave Channel Grate	Black	16	0.88		1 ft. Mini Channel Wave Cast Iron Channel Grate. Open surface area 4.11 square inches per foot. 12.56 GPM per foot. Class B load rated.
555CI	1' Wave Cast Iron Channel Grate	Raw Iron	1	1.30	10ND	
629	Stainless Steel Screws, FH #20 x 1-1/2"	Metal	40	n/a	10ND	
Fits #500 Mini Channel. (see page 74). ADA Compliant.						

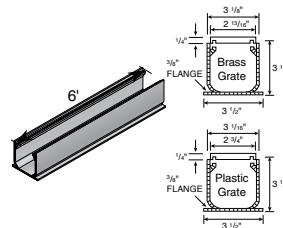

Part No.	Description	Color	Pkg. Qty.	Wt. Ea. (lbs.)	Product Class	Specifications
500	6' Mini Channel Drain	Gray	48 ft.	3.26	25PF	6 ft. PVC Mini Channel Drain with inverse flying-buttruss design, bottom flange, patented honeycomb reinforced walls and UV inhibitor.
Grate should be recessed 1/8" below finish grade in non-traffic applications. Grate should be recessed 1/4" in traffic applications.						

## PROFILE CHANNEL DRAINS

### Mini Channel™ Accessories

Excellent for light duty applications, including residential pools, concrete and paver patios, spas and tennis courts.

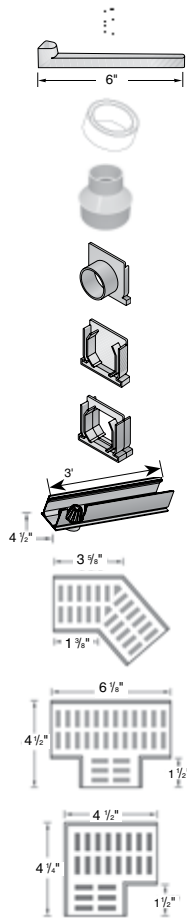

Part No.	Description	Color	Pkg. Qty.	Wt. Ea. (lbs.)	Product Class
529	Stainless Steel Screws, FH #4 x 5/8"	Steel	64	0.10	25PF
230	6" Channel Installation Stake	Gray	24	0.04	25PF
532	2" Sch. 40 Hub to 3" S&D Spigot Adapter	White	20	0.14	30PV
533	2" Sch. 40 Hub to 4" S&D Spigot Adapter	White	20	0.34	30PV
546	Spigot End Outlet for 2" Sch. 40 Pipe Fitting	Gray	10	0.15	25PF
547	3" Channel End Cap	Gray	20	0.12	25PF
548	3" Channel Coupling	Gray	20	0.12	25PF
550	3' Long Channel with 2" Sch. 40 Spigot Bottom Outlet	Gray	6	2.17	25PF
5300	Fabricated 45° Elbow with Grate	Gray	1	0.40	25PF
5303	Fabricated 45° Elbow with Grate	Sand	1	0.40	25PF
5370	Fabricated Tee with Grate	Gray	1	0.50	25PF
5372	Fabricated Tee with Grate	Black	1	0.50	25PF
5374	Fabricated Tee with Grate	Brick Red	1	0.50	25PF
5380	Fabricated 90° Elbow with Grate	Gray	1	0.40	25PF
5383	Fabricated 90° Elbow with Grate	Sand	1	0.40	25PF

DRAINAGE

### Mini Channel™ Paver Installation

NDS Mini Channel and grates are dimensionally compatible with standard 2-3/8" clay and concrete paving systems. Both decorative and standard grate options make Mini Channel an ideal choice for drainage on paver parking courts, patios and plazas.





# PROFILE CHANNEL DRAINS

## Spee-D® Channel Drains

Ideal for commercial as well as residential applications. Effective in everything from patios to light vehicular traffic areas.

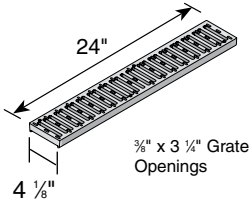
DRAINAGE



Part No.	Description	Color	Pkg. Qty.	Wt. Ea. (lbs.)	Product Class	Specifications
229	Stainless Steel Screws, FH #8 x 1"	Steel	48	0.06	25PF	2 ft. Structural Foam Polyolefin Secured Channel Grate with UV inhibitor. Open surface area 16.76 square inches per foot. 51.27 GPM per foot.
240	2' Channel Grate	White	24 ft.	1.33	25PF	
241	2' Channel Grate	Gray	24 ft.	1.33	25PF	
242	2' Channel Grate	Green	24 ft.	1.33	25PF	
243	2' Channel Grate	Black	24 ft.	1.33	25PF	
244	2' Channel Grate	Sand	24 ft.	1.33	25PF	
251	2' Channel Grate	Brick Red	24 ft.	1.42	25PF	
 (see page 74). ADA Compliant.						

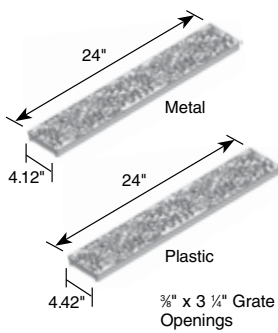

Part No.	Description	Color	Pkg. Qty.	Wt. Ea. (lbs.)	Product Class	Specifications
829	Stainless Steel Screws, FH #8 x 1-1/4"	Steel	48	0.06	25PF	2 ft. Structural Foam Polyolefin decorative botanical Channel Grate with UV inhibitor. Open surface area 7.78 square inches per foot. 23.80 GPM per foot.
252S	2' Channel Botanical Grate	Sand	24 ft.	1.74		
252GR	2' Channel Botanical Grate	Green	24 ft.	1.74		
252GY	2' Channel Botanical Grate	Gray	24 ft.	1.74		
252	2' Channel Botanical Grate	Black	24 ft.	1.74		2 ft. Cast Iron decorative botanical Channel Grate. Open surface area 8.99 square inches per foot. 27.50 GPM per foot. Class B load rated.
252CI	2' Cast Iron Channel Botanical Grate	Raw Iron	2 ft.	7.06		
629	Stainless Steel Screws, FH #20 x 1-1/2"	Metal	40	n/a	10ND	
 (see page 74). ADA Compliant.						

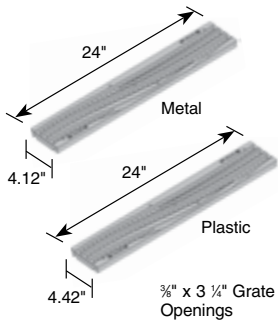

Part No.	Description	Color	Pkg. Qty.	Wt. Ea. (lbs.)	Product Class	Specifications
829	Stainless Steel Screws, FH #8 x 1-1/4"	Steel	48	0.06	25PF	2 ft. Structural Foam Polyolefin decorative wave Channel Grate with UV inhibitor. Open surface area 7.78 square inches per foot. 23.80 GPM per foot.
253S	2' Channel Wave Grate	Sand	24 ft.	1.84		
253GR	2' Channel Wave Grate	Green	24 ft.	1.84		
253GY	2' Channel Wave Grate	Gray	24 ft.	1.84		
253	2' Channel Wave Grate	Black	24 ft.	1.84		2 ft. Cast Iron decorative wave Channel Grate. Open surface area 7.41 square inches per foot. 22.67 GPM per foot. Class B load rated.
253CI	2' Cast Iron Channel Wave Grate	Raw Iron	2 ft.	7.52		
629	Stainless Steel Screws, FH #20 x 1-1/2"	Metal	40	n/a	10ND	
 (see page 74). ADA Compliant.						

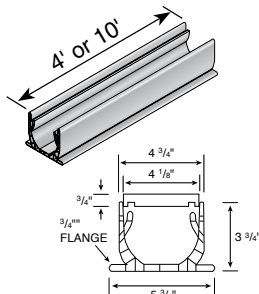

Part No.	Description	Color	Pkg. Qty.	Wt. Ea. (lbs.)	Product Class	Specifications
400	4' Channel Drain	Gray	24 ft.	4.83	25PF	NDS #400, 4 ft. PVC Spee-D® Channel Drain with inverse flying-buttress design, bottom flange, patented honeycomb reinforced walls and UV inhibitor.
400-10	10' Channel Drain	Gray	60 ft.	11.00	25PF	
Grate should be recessed 1/8" below finish grade in non-traffic applications. Grate should be recessed 1/4" in traffic applications.						

## PROFILE CHANNEL DRAINS

### Spee-D® Accessories

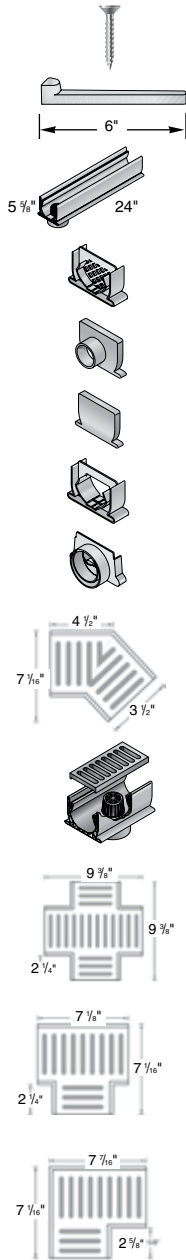

Part No.	Description	Color	Pkg. Qty.	Wt. Ea. (lbs.)	Product Class
229	Stainless Steel Screws, FH #8 x 1"	Steel	48	0.06	25PF
230	6" Channel Installation Stake	Gray	24	0.04	25PF
234	2' long fabricated 3" & 4" Spigot Bottom Outlet with Strainer. Fits 3" or 4" Sewer and Drain Fittings. Grates not included.	Gray	12	2.67	25PF
245	Channel Strainer Coupling	Gray	20	0.35	25PF
246	2" Schedule 40 SPT End Outlet	Gray	10	0.40	25PF
247	Channel End Cap	Gray	10	0.40	25PF
248	Channel Coupling	Gray	20	0.40	25PF
249	3" & 4" Offset End Outlet Connects to 3" S&D Pipe, 4" S&D Fittings	Gray	10	0.50	25PF
2301	Fabricated 45° Elbow with Grate	Gray	1	2.00	25PF
2351	7" Fabricated Grate 4" Bottom Outlet with Grate	Gray	1	1.70	25PF
2361	Fabricated Cross and Grate	Gray	1	3.00	25PF
2370	Fabricated Tee with Grate	White	1	3.00	25PF
2371	Fabricated Tee with Grate	Gray	1	3.00	25PF
2372	Fabricated Tee with Grate	Green	1	3.00	25PF
2381	Fabricated 90° Elbow with Grate	Gray	1	3.00	25PF

DRAINAGE

## PRO SERIES CHANNEL DRAINS



NDS Pro Series is a lightweight channel drain system with interlocking joints and a modular design, so systems are flexible and connections are made quickly and easily.

Load Rated: Up to Class C with appropriate grate.  
For Residential and Commercial applications.

The NDS Pro Series modular design offers flexibility as each section of channel can be snapped together for longer runs or divided down to lengths as short as 4" for smaller, interlocking sections.

Lightweight parts connect easily to sewer and drain pipe and fittings or Sch 40 pipe and fittings, and side and bottom outlets can be connected anywhere along the channel run.

- Channel-to-channel clips for reduced motion during installation
- Rebar clips instead of lower mount clips for an easier install
- Side ribs for increased strength
- Lay-flat design stabilizes channel during installation
- Thicker channel walls for additional strength

All this, and the channel still fits easily with all grates and end connectors.

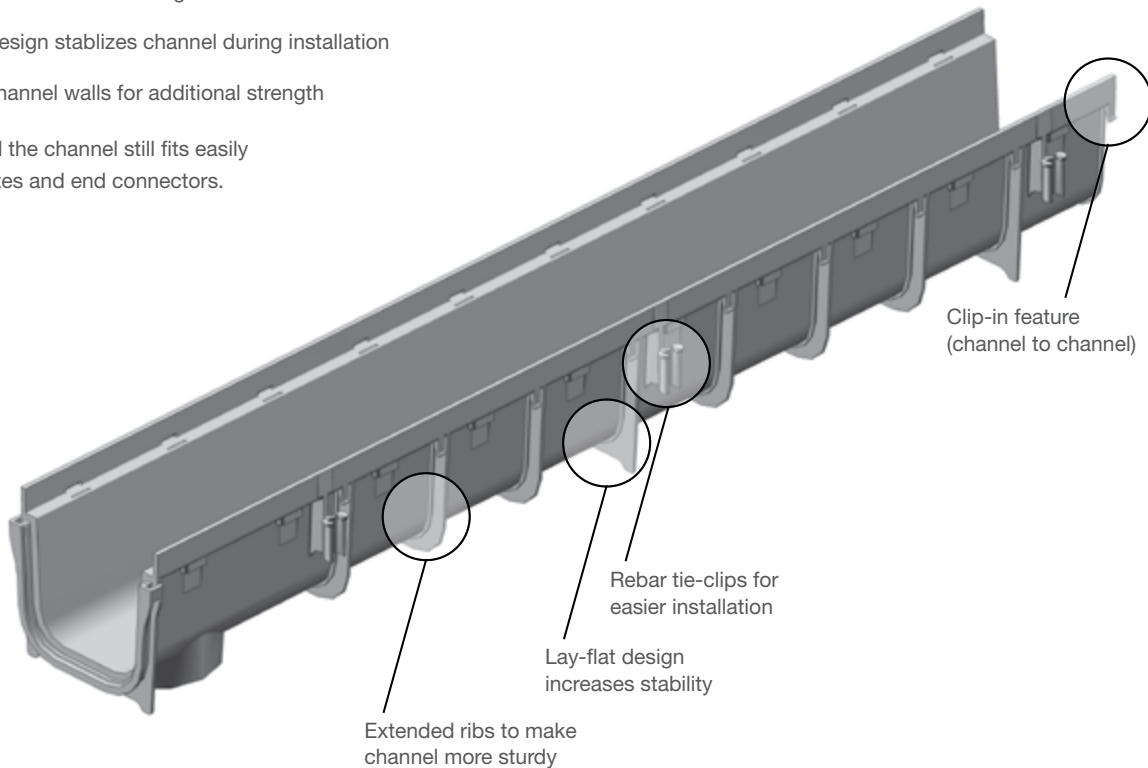



## PRO SERIES CHANNEL DRAINS

### Details

- Create a channel as long as you need, or reduce to lengths as short as 4" for smaller, interlocking sections.
- End cap/knockout end and outlet fitting simplify assembly and installation.
- Flexible and easy: side and bottom outlets can be inserted at any location along the channel run.
- Available in four widths: 3", 5", 8" and 12"
- Available in two depths: deep for heavy flows, shallow for slabs or where little fall depth is available.
- Modular design comes in 1/2 meter (19 11/16") and 1 meter (39 3/8") pieces with interlocking end joints.
- Joints eliminate couplings and are specially designed to withstand concrete expansion and contraction.

### Materials & Standards

- Polypropylene (3" & 5" channels) and polyvinyl chloride (8" & 12" channels) create a structurally-compact, water-tight channel.
- All parts contain UV inhibitors to prevent fading and cracking.

### Load Recommendations

- Pedestrian Grates offer heel-proof pattern.
- Polyolefin Light Vehicular Grate for use in areas with passenger vehicles and light trucks with speeds less than 20 MPH.
- Load Star or Ductile Channel Grates for heavy-duty traffic.
- See individual products for details.

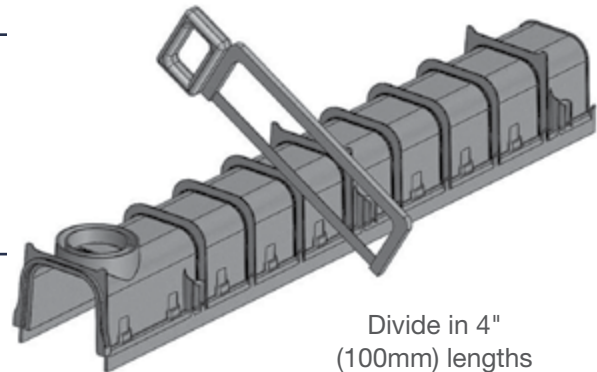

DRAINAGE

### Pre-Assembled Channel Drain Systems

Our Modular Pro Series channel drains also come in pre-assembled kits to decrease installation time. They act as perimeter drains, quickly removing water from hardscapes and directing it away from building structures.

The 3" and 5" wide pre-assembled channel drain kits include a one-meter (39-3/8") channel drain and grate, end outlet, and end cap. A bottom outlet is built into each channel section. This allows for easy ordering and less inventorying, as everything is included under one part number.

Our unique Pro Series interlocking channel design allows each channel to securely lock to the next for a secure, tight fit, with no couplings required. The pre-assembled Pro Series channel drains are a great solution for your drainage needs.

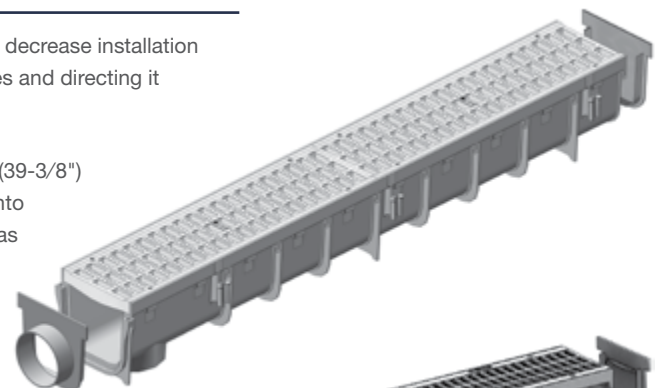

NDS #864  
Polypropylene

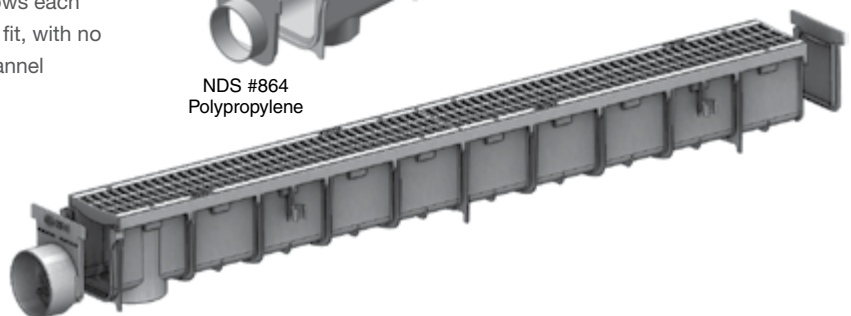

NDS #764  
PVC

# PRO SERIES CHANNEL DRAINS

## 3" Pro Series Channel™ Drains

DRAINAGE

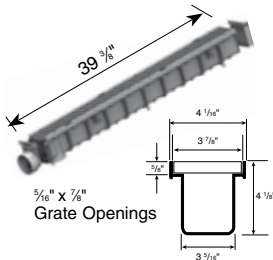

Part No.	Description	Color	Pkg. Qty.	Wt. Ea. (lbs.)	Product Class	Specifications
764	3" x 1 Meter Light Traffic Channel Grate & Channel Drain Kit	Light Gray	10	3.50	25IN	3" wide Light Traffic Channel Grate and Channel Drain with mechanical interlocking joints and UV inhibitors. Open surface area 23.63 square inches per foot. 76.85 GPM per foot.
764DISP	3" Pro Series Channel Display (16 Kits)		1	105.00	25IN	
Includes 1 end outlet (#713) and 1 end cap (#712). Bottom outlet fits 3" S&D fittings. Grate should be recessed 1/8" below finish grade in non-traffic applications. Grate should be recessed 1/4" in traffic applications. (see page 74). ADA Compliant.						

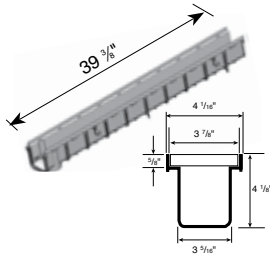

Part No.	Description	Color	Pkg. Qty.	Wt. Ea. (lbs.)	Product Class	Specifications
710	3" x 1 Meter Channel Drain*	Light Gray	12	1.90	25IN	3" wide Light Traffic Channel with mechanical interlocking joints and UV inhibitors. Polypropylene.
Bottom outlet fits 3" S&D fittings. Grate should be recessed 1/8" below finish grade in non-traffic applications. Grate should be recessed 1/4" in traffic applications. *Produced under license of First Plast S.R.L.- Italy. (see page 74). ADA Compliant.						

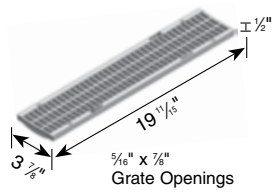

Part No.	Description	Color	Pkg. Qty.	Wt. Ea. (lbs.)	Product Class	Specifications
714	3" x 20" Light Traffic Channel Grate*	Light Gray	24	0.70	25IN	3" wide Light Traffic Channel Grate. Open surface area 23.63 square inches per foot. 72.29 GPM per foot. Polypropylene.
Requires 4 #229 screws. *Produced under license of First Plast S.R.L.- Italy. (see page 74). ADA Compliant.						

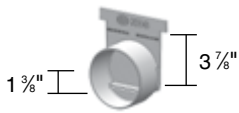

Part No.	Description	Color	Pkg. Qty.	Wt. Ea. (lbs.)	Product Class	Specifications
713	3" End Cap/End Outlet	Light Gray	12	0.10	25IN	3" Channel End Cap/End Outlet. Polypropylene.
Fits 3" Fittings.						

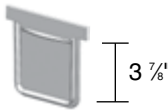

Part No.	Description	Color	Pkg. Qty.	Wt. Ea. (lbs.)	Product Class	Specifications
712	3" End Cap	Light Gray	20	0.05	25IN	3" Channel End Cap. Polypropylene.



Part No.	Description	Color	Pkg. Qty.	Wt. Ea. (lbs.)	Product Class	Specifications
229	Stainless Steel Screws FH H8 x 1"	Steel	48	0.06	25PF	

## PRO SERIES CHANNEL DRAINS

### 5" Pro Series Channel™ Drains

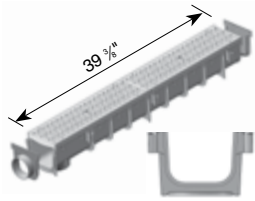

3/8" x 1 1/4"  
Grate Openings

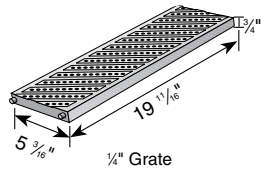

1/4" Grate  
Openings

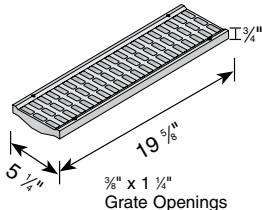

3/8" x 1 1/4"  
Grate Openings

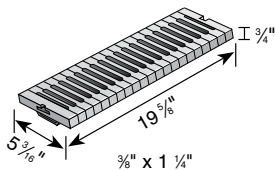

3/8" x 1 1/4"  
Grate Openings

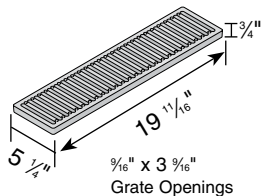

9/16" x 3 3/16"  
Grate Openings



Part No.	Description	Color	Pkg. Qty.	Wt. Ea. (lbs.)	Product Class	Specifications
864	5" x 1 Meter Light Traffic Includes 1 end outlet & 1 end cap	Light Gray	9	5.67	25IN	5" wide Light Traffic Channel Grate and Channel Drain with mechanical interlocking joints and UV inhibitors. Open surface area 23.52 square inches per foot. 71.95 GPM per foot.
864DISP	5" Pro Series Channel Display (20 Kits)		1	113.40	25IN	
 Grate should be recessed 1/8" below finish grade in non-traffic applications. Grate should be recessed 1/4" in traffic applications. Bottom outlet fits 3" and 4" S&D fittings. (see page 74)						

Part No.	Description	Color	Pkg. Qty.	Wt. Ea. (lbs.)	Product Class	Specifications
826	5" x 20" Pedestrian Traffic Channel Grate	Light Gray	10	1.00	25IN	5" wide UV-protected Structural Foam Polyolefin Pedestrian Traffic Channel Grate. Open surface area 4.86 square inches per foot. 24.26 GPM per foot.
 Requires #829 screws. (see page 74). ADA Compliant/Heelproof.						

Part No.	Description	Color	Pkg. Qty.	Wt. Ea. (lbs.)	Product Class	Specifications
814	5" x 20" Light Traffic Channel Grate	Light Gray	10	1.16	25IN	5" wide Structural Foam Polyolefin Light Traffic Channel Grate with UV inhibitors. Open surface area 23.52 square inches per foot. 71.95 GPM per foot.
815	5" x 20" Light Traffic Channel Grate	Green	10	1.16	25IN	
816	5" x 20" Light Traffic Channel Grate	Black	10	1.16	25IN	
817	5" x 20" Light Traffic Channel Grate	Sand	10	1.16	25IN	
818	5" x 20" Light Traffic Channel Grate	Brick Red	10	1.16	25IN	
819	5" x 20" Light Traffic Channel Grate	White	10	1.16	25IN	
 Requires #829 screws. (see page 74). ADA Compliant.						

Part No.	Description	Color	Pkg. Qty.	Wt. Ea. (lbs.)	Product Class	Specifications
828	5" x 20" Load Star Heavy Traffic Channel Grate	Gray	10	2.35	25IN	5" wide UV-protected high-impact glass-reinforced nylon Heavy Traffic Channel Grate. Open surface area 15.92 square inches per foot. 48.70 GPM per foot.
 Requires 4 screws per grate. Requires #829 screws. (see page 74)						

Part No.	Description	Color	Pkg. Qty.	Wt. Ea. (lbs.)	Product Class	Specifications
823	5" x 20" Ductile Channel Grate	Black	1	12.30	25IN	5" wide heavy-duty Ductile Heavy Traffic Channel Grate. Open surface area 22.90 square inches per foot. 70.05 GPM per foot.
 (see page 74). ADA Compliant.						

Part No.	Description	Color	Pkg. Qty.	Wt. Ea. (lbs.)	Product Class	Specifications
829	Stainless Steel Screws FH #6 x 1 1/4"	Steel	40	0.15	25PF	

## PRO SERIES CHANNEL DRAINS

### 5" Pro Series Channel™ Drains (continued)

DRAINAGE

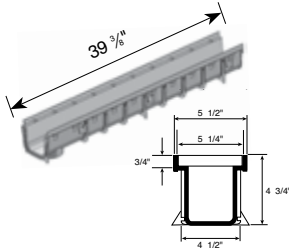

Part No.	Description	Color	Pkg. Qty.	Wt. Ea. (lbs.)	Product Class	Specifications
800	5" x 1 Meter Deep Profile Channel Drain	Light Gray	10	4.00	25IN	5" wide Deep Profile Channel Drain with mechanical interlocking joints, integrated knockout bottom outlet. Polypropylene.
	Integrated knockout bottom outlet fits 3" and 4" S&D fittings. Grate should be recessed 1/8" below finish grade in non-traffic applications. Grate should be recessed 1/4" in traffic applications.					

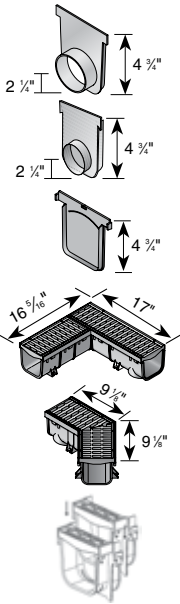

Part No.	Description	Color	Pkg. Qty.	Wt. Ea. (lbs.)	Product Class	Specifications
811	5" Deep Profile 3" S&D Pipe Hub & 4" S&D Fitting SPT End Outlet	Light Gray	10	0.40	25IN	5" wide Deep Profile End Outlet. PVC.
813	5" Deep Profile End Cap/3" S&D Hub & 4" S&D SPT Knockout End Outlet	Light Gray	10	0.40	25IN	5" wide Deep Profile End Cap/End Outlet. PVC.
812	5" Deep Profile End Cap	Light Gray	10	0.13	25IN	5" wide Deep Profile End Cap. PVC.
861	5" Deep Profile Grate & Channel Drain 90° Elbow	Light Gray	1	3.44	25IN	
862	5" Deep Profile Grate & Channel Drain 45° Elbow	Light Gray	1	3.44	25IN	
PSRC-864	Quik-Turn™ 5" Deep Radius Coupling Provides a 6 degree bend left or right	Light Gray	9	0.30	25IN	

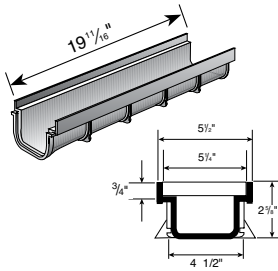

Part No.	Description	Color	Pkg. Qty.	Wt. Ea. (lbs.)	Product Class	Specifications
820	5" x 20" Shallow Profile Channel Drain*	Light Gray	10	1.35	25IN	5" wide Shallow Profile UV-protected high-impact PVC Channel Drain with mechanical interlocking joint.
	Grate should be recessed 1/8" below finish grade in non-traffic applications. Grate should be recessed 1/4" in traffic applications. *Produced under license of First Plast S.R.L. - Italy.					

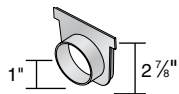

Part No.	Description	Color	Pkg. Qty.	Wt. Ea. (lbs.)	Product Class	Specifications
821	5" Shallow Profile End Cap/1 1/2" Sch. 40 SPT Knockout End Outlet*	Light Gray	10	0.15	25IN	5" wide Shallow Profile high-impact PVC End Cap/End Outlet.
	*Produced under license of First Plast S.R.L. - Italy.					

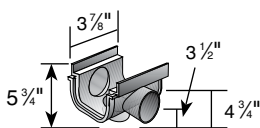

Part No.	Description	Color	Pkg. Qty.	Wt. Ea. (lbs.)	Product Class	Specifications
822	5" Shallow Profile 3" S&D SPT Bottom Outlet/1 1/2" Sch. 40 SPT Side Outlet	Light Gray	10	0.60	25IN	5" wide Shallow Profile high-impact PVC Bottom/Side Outlet.

## PRO SERIES CHANNEL DRAINS

### 8" Pro Series Channel™ Drains

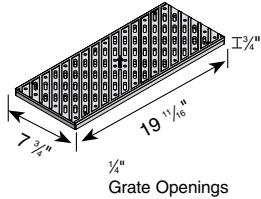

Part No.	Description	Color	Pkg. Qty.	Wt. Ea. (lbs.)	Product Class	Specifications
836	8" x 20" Pedestrian Traffic Channel Grate	Light Gray	1	1.55	25IN	8" wide UV-protected Structural Foam Polyolefin Pedestrian Traffic Channel Grate. Open surface area 13.82 square inches per foot. 42.28 GPM per foot.
	Requires #829 screws. 4 screws per grate. (see page 74). ADA Compliant/Heelproof.					

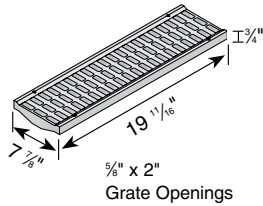

Part No.	Description	Color	Pkg. Qty.	Wt. Ea. (lbs.)	Product Class	Specifications
837	8" x 20" Light Traffic Channel Grate	Light Gray	1	3.00	25IN	8" wide UV-protected Structural Foam Polyolefin Light Traffic Channel Grate. Open surface area 30.28 square inches per foot. 92.63 GPM per foot.
	Requires #829 screws. 4 screws per grate. (see page 74)					

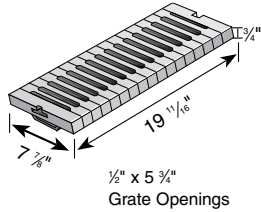

Part No.	Description	Color	Pkg. Qty.	Wt. Ea. (lbs.)	Product Class	Specifications
838	8" x 20" Load Star Heavy Traffic Channel Grate*	Light Gray	1	3.59	25IN	8" wide UV-protected high-impact glass-reinforced nylon Heavy Traffic Channel Grate. Open surface area 30.85 square inches per foot. 94.37 GPM per foot.
	Requires #829 screws. 4 screws per grate. *Produced under license of First Plast S.R.L. - Italy. (see page 74). ADA Compliant.					

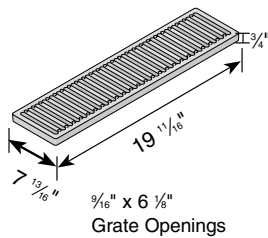

Part No.	Description	Color	Pkg. Qty.	Wt. Ea. (lbs.)	Product Class	Specifications
888	8" x 20" Ductile Channel Grate	Black	1	22.24	25IN	8" wide heavy-duty Ductile Heavy Traffic Channel Grate. Open surface area 23.80 square inches per foot. 71.28 GPM per foot.
	#829 screws may be used. 4 screws per grate. (see page 74)					

## PRO SERIES CHANNEL DRAINS

### 8" Pro Series Channel™ Drains (continued)

DRAINAGE

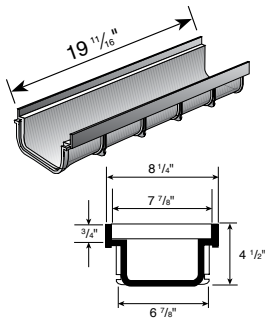

Part No.	Description	Color	Pkg. Qty.	Wt. Ea. (lbs.)	Product Class	Specifications
830	8" x 20" Shallow Profile Channel Drain*	Light Gray	1	2.00	25IN	8" wide Shallow Profile high-impact PVC Channel Drain with mechanical interlocking joints and UV inhibitors.
	Grate should be recessed 1/8" below finish grade in non-traffic applications. Grate should be recessed 1/4" in traffic applications. *Produced under license of First Plast S.R.L.- Italy.					

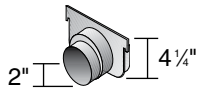

Part No.	Description	Color	Pkg. Qty.	Wt. Ea. (lbs.)	Product Class	Specifications
831	8" Shallow Profile End Cap/ 3" S&D SPT Knockout End Outlet*	Light Gray	1	0.49	25IN	8" wide Shallow Profile high-impact PVC End Cap/ End Outlet.
	*Produced under license of First Plast S.R.L.- Italy.					

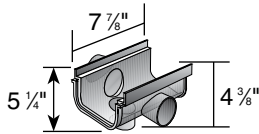

Part No.	Description	Color	Pkg. Qty.	Wt. Ea. (lbs.)	Product Class	Specifications
832	8" Shallow Profile 3" S&D SPT Side Outlet*	Light Gray	1	1.38	25IN	8" wide Shallow Profile high-impact PVC Bottom/Side Outlet.
	Bottom outlet fits 4" S&D pipe, 3" S&D fittings. *Produced under license of First Plast S.R.L.- Italy.					

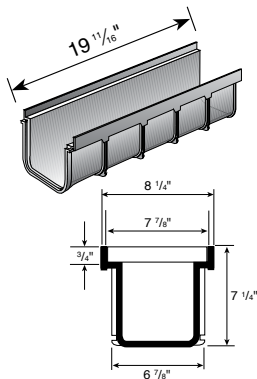

Part No.	Description	Color	Pkg. Qty.	Wt. Ea. (lbs.)	Product Class	Specifications
833	8" x 20" Deep Profile Channel Drain	Light Gray	1	2.80	25IN	8" wide Deep Profile high-impact PVC Channel Drain with mechanical interlocking joints and UV inhibitors.
	Grate should be recessed 1/8" below finish grade in non-traffic applications. Grate should be recessed 1/4" in traffic applications.					

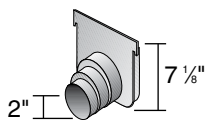

Part No.	Description	Color	Pkg. Qty.	Wt. Ea. (lbs.)	Product Class	Specifications
834	8" Deep Profile End Cap/3" & 4" S&D SPT Knockout End Outlet	Light Gray	10	0.51	25IN	8" wide Deep Profile high-impact PVC End Cap/End Outlet.
	*Produced under license of First Plast S.R.L.- Italy.					

## PRO SERIES CHANNEL DRAINS

### 12" Pro Series Channel™ Drains

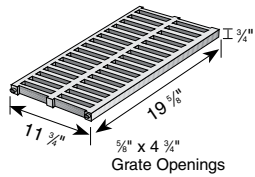

Part No.	Description	Color	Pkg. Qty.	Wt. Ea. (lbs.)	Product Class	Specifications
847	12" x 20" Light Traffic Channel Grate*	Gray	1	4.64	251N	12" wide UV-protected high-impact PVC Light Traffic Channel Grate. Open surface area 48.77 square inches/foot. 149.19 GPM per foot.
	*Produced under license of First Plast S.R.L. - Italy. (see page 74)					

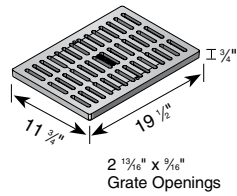

Part No.	Description	Color	Pkg. Qty.	Wt. Ea. (lbs.)	Product Class	Specifications
845	12" x 20" Cast Iron Heavy Traffic Channel Grate	Black	1	28.00	251N	12" Wide Cast Iron Heavy Traffic Channel Grate. Open surface area 46.70 square inches per foot. 142.86 GPM per foot.
	(see page 74)					

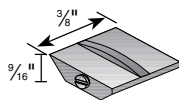

Part No.	Description	Color	Pkg. Qty.	Wt. Ea. (lbs.)	Product Class	Specifications
849	Grate Security Clip*	Gray	10	0.40	251N	
	For use with 845 and 847 grates and 840 or 843 channels only (2 per grate). Mounts inside channel drain and secures grate. Screw and nut included.					
	*Produced under license of First Plast S.R.L. - Italy.					

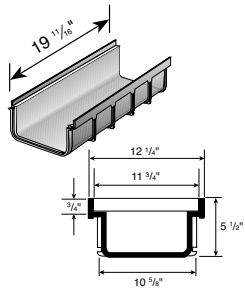

Part No.	Description	Color	Pkg. Qty.	Wt. Ea. (lbs.)	Product Class	Specifications
840	12" x 20" Shallow Profile Channel Drain	Light Gray	1	4.00	251N	12" wide Shallow Profile UV-protected high-impact PVC Channel Drain with mechanical interlocking joints.
	Grate should be recessed 1/8" below finish grade in non-traffic applications. Grate should be recessed 1/4" in traffic applications.					

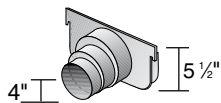

Part No.	Description	Color	Pkg. Qty.	Wt. Ea. (lbs.)	Product Class	Specifications
841	12" Shallow Profile End Cap/3" & 4" S&D SPT Knockout End Outlet	Light Gray	1	1.00	251N	12" wide Shallow Profile high-impact PVC End Cap/3" & 4" Corrugated S&D Pipe.

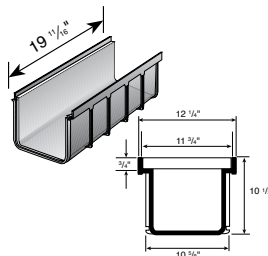

Part No.	Description	Color	Pkg. Qty.	Wt. Ea. (lbs.)	Product Class	Specifications
843	12" x 20" Deep Profile Channel Drain*	Light Gray	1	6.00	251N	12" wide Deep Profile UV-protected high-impact PVC Channel Drain with mechanical interlocking joints.
	Grate should be recessed 1/8" below finish grade in non-traffic applications. Grate should be recessed 1/4" in traffic applications.					
	*Produced under license of First Plast S.R.L. - Italy.					

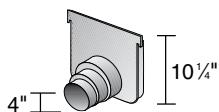

Part No.	Description	Color	Pkg. Qty.	Wt. Ea. (lbs.)	Product Class	Specifications
844	12" Deep Profile End Cap/3" & 4" S&D SPT Knockout End Outlet*	Light Gray	1	1.60	251N	12" wide Deep Profile high-impact PVC End Cap/3" & 4" Corrugated S&D Pipe.
	*Produced under license of First Plast S.R.L. - Italy.					

## CAPACITY RECOMMENDATIONS – CHANNEL & TRENCH DRAINS

Product	Size	Applications	Capacity
Micro Channel	1.25" Wide	Small Patio	Small Capacity
Mini Channel	2.75" Wide	Small Pool Deck and Patios	Small Capacity
Spee-D® Channel	4" Wide	Pool Decks and Patios	Medium Capacity
Pro 764 Series Channel	3" Wide	Patio, Pool Decks and Driveways	Small Capacity
Pro 864 Series Channel	5" Wide	Patio, Pool Decks and Driveways	Large Capacity
Pro Series Channel	8" & 12" Wide	Patio, Pool Decks and Driveways	Large Capacity
Dura Slope™ Trench Drain	6" Wide	Pre-sloped for Driveways, Warehouses, Loading Docks and Larger Commercial Projects	Large Capacity

## LOAD RECOMMENDATION GUIDE

### Class A

- Loads of 1-60 psi.
- Recommended for pedestrians, bicycles and wheelchair traffic.



### Class B

- Loads of 61-175 psi.
- Recommended for medium-duty pneumatic tire traffic, autos and light trucks at speeds less than 20 m.p.h.



### Class C

- Loads of 176-325 psi.
- Recommended for heavy-duty pneumatic tire forklifts and tractor-trailers at speeds less than 20 m.p.h., H-20 rated.



### Class D

- Loads of 326-575 psi.
- Recommended for heavy-duty hard tire forklifts at speeds less than 20 m.p.h., H-20 rated.



Notes: Some installations may require a concrete collar to meet load rating. Load ratings are based on encasing product in concrete. Product must be installed using NDS instructions.

Cast iron grates will oxidize over time and rust, forming an iron-oxide patina. The iron-oxide layer begins red-orange in color and ages to a deep, rich brown. This patina is tightly adhered and protects the iron beneath it from further oxidation. Iron grates with a rust patina are structurally sound and will last for decades.

Visit [ndspro.com](http://ndspro.com) for complete installation specifications, guidelines & details.



Our products are engineered and produced for performance, durability, ease of installation and the efficient use of resources.

