

MAESTRO[®] Fan Speed Control

English

P/N 033-102



Quiet Fan Speed Control Multi-Location System

Canopy Module

CM-FQ1: 120 V~ 60 Hz
1.0 A fan

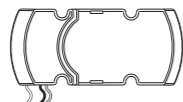

Wall Control

MA-FQ4M: 120 V~ 60 Hz
4.0 A (up to 4 CM-FQ1)

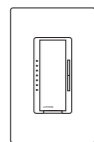

Accessory Control

MA-AFQ4: 120 V~ 60 Hz
4.0 A

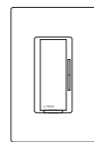

Warning: For use with one to four ceiling paddle fans only. Do not use with an exhaust fan.

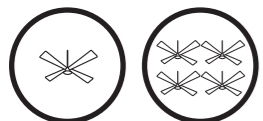

One to four ceiling fans only



No exhaust fans

Important Notes

Please read before installing.

- Caution:** To avoid overheating and possible damage to other equipment, do not use to control receptacles, lighting fixtures, transformer-supplied appliances, solid state fan motors, or exhaust fans. For exhaust fans use Lutron fully variable fan speed controls.
- Install in accordance with all national and local electrical codes.
- When no "grounding means" exist within the wallbox then the NEC[®] 2002, Article 404-9 allows a wall control without a grounding connection to be installed as a replacement, as long as a plastic, noncombustible wallplate is used. For this type of installation, cap or remove the green ground wire on the wall control and use an appropriate wallplate such as Lutron's Claro[®] or Satin Colors[™] series wallplates.
- The *Maestro* fan speed control system consists of a Wall Control, one to four Canopy Modules, and up to two Accessory Controls. All must be installed correctly before attempting to control the fans. Do not attempt to mix Lutron controls with those from other manufacturers, or mix Lutron controls not labeled for use together.
- This system is not compatible with fans having a control system built into the motor.
- Do not paint Wall Control, Canopy Module, or Accessory Control.
- Maestro* Controls are not compatible with standard 3-way/4-way switches.
- Accessory Controls (MA-AFQ4) cannot be used individually and must be used in conjunction with a *Maestro* Wall Control (MA-FQ4M) in a 3-way/4-way application.
- In any 3-way/4-way circuit use only one Wall Control (MA-FQ4M) with up to 2 Accessory Controls (MA-AFQ4).
- Operate between 32 °F (0 °C) and 104 °F (40 °C) room temperature. For indoor use only.
- Wall Control and Accessory Controls may feel warm to the touch during normal operation.
- Recommended wallbox depth is 2.5" (64 mm) minimum.
- Clean controls with a soft damp cloth only.** Do not use any chemical cleaners.
- This system cannot be used to change the direction of the fan. To change the fan direction, stop the fan, and then change the position of the switch located on the body of the fan.
- Do not use pull chains to operate fan(s) after installing this system.
- Each Canopy Module must be installed within a fan canopy enclosure.
- This device complies with Part 15 of the FCC Rules. Operation is subject to the following two conditions: (1) this device may not cause harmful interference, and (2) this device must accept any interference received, including interference that may cause undesired operation.

Multigang Installations

When installing more than one control in the same wallbox, it may be necessary to remove all inner side sections prior to wiring (see below). Using pliers, bend side sections up and down until they break off. Repeat for each side section to be removed. **Note: Product does not require derating when side sections are removed.**

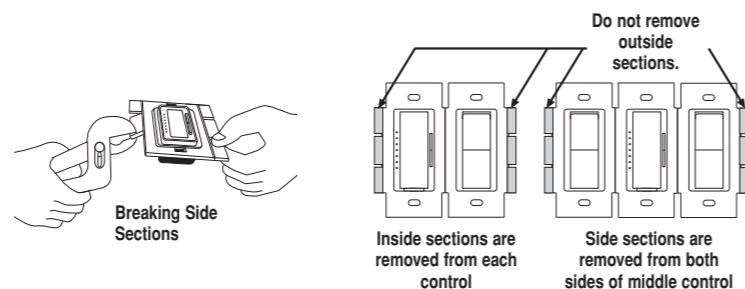

Operation

Tap Button

- Tap once when fan is off - Fan speed increases to preset level.
- Tap once when fan is on - Fan speed slows to off.
- Tap twice quickly - Fan speed increases to full speed.

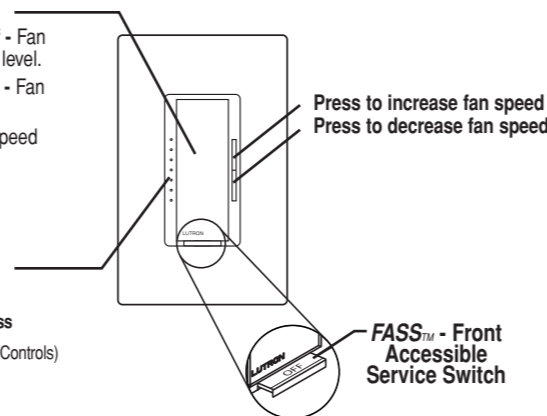

LEDs

Indicate exact fan speed

LEDs will change with each press

(LEDs not available on Accessory Controls)

Troubleshooting

Symptom	Possible Cause
Fan does not turn ON or no LEDs turn ON.	<ul style="list-style-type: none"> Front Accessible Service Switch (FASS) on control is pulled out to the OFF position. Manual switch on fan is off (ex: pull chain). Breaker is OFF or tripped (or fuse blown). Fan direction switch is between forward and reverse. Wiring error, call Lutron Technical Support Center at +1-800-523-9466.
LEDs on Wall Control cycle rapidly and bottom LED is ON.	<ul style="list-style-type: none"> Unit is not activated properly. Activate system as described in Step 15. Wiring error, call Lutron Technical Support Center at +1-800-523-9466.
LEDs on Wall Control cycle rapidly and second lowest LED is ON.	<ul style="list-style-type: none"> Communication error. Check wiring; if error continues, call Lutron Technical Support Center at +1-800-523-9466.
Fan vibrates or wobbles.	<ul style="list-style-type: none"> Fan blades not properly balanced. See fan manufacturer's instructions.
Fan speeds too slow.	<ul style="list-style-type: none"> Fan pull chain not set to high.
Wall Control LEDs respond as expected but fan does not respond properly.	<ul style="list-style-type: none"> Fan pull chain not set to high. Wiring error, call Lutron Technical Support Center at +1-800-523-9466.

Technical Assistance

If you have questions concerning the installation or operation of this product, call the **Lutron Technical Support Center**. Please provide exact model number when calling.



U.S.A. and Canada (24 hrs/7 days):
+1-800-523-9466

Other countries 8am – 8pm ET:
+1-610-282-3800



Fax +1-610-282-6311



http://www.lutron.com

Reference Wiring Diagram

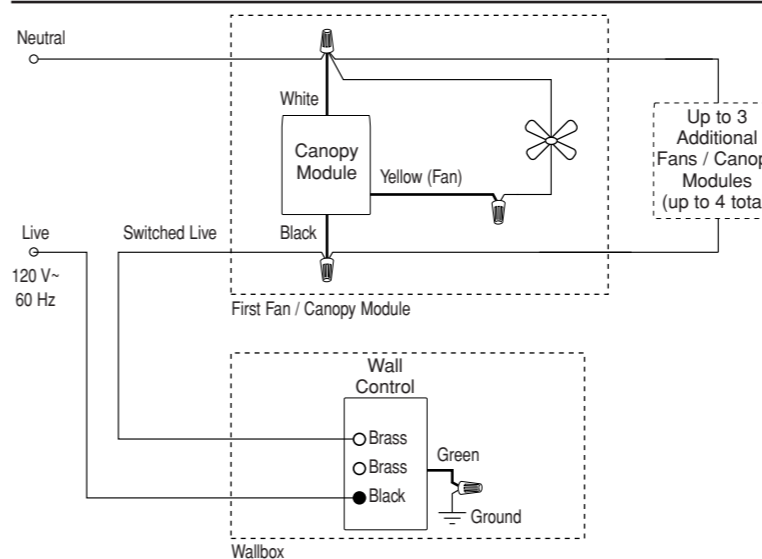

See Step 12 for two- and three-location control wiring.

NOTE: This equipment has been tested and found to comply with the limits for a Class B digital device, pursuant to Part 15 of the FCC Rules. These limits are designed to provide reasonable protection against harmful interference in a residential installation. This equipment generates, uses and can radiate radio frequency energy and, if not installed and used in accordance with the instructions, may cause harmful interference to radio communications. However, there is no guarantee that interference will not occur in a particular installation. If this equipment does cause harmful interference to radio or television reception, which can be determined by turning the equipment off and on, the user is encouraged to try to correct the interference by one or more of the following measures:

- Reorient or relocate the receiving antenna.
- Increase the separation between the equipment and receiver.
- Connect the equipment into an outlet on a circuit different from that to which the receiver is connected.
- Consult the dealer or an experienced radio/TV technician for help.

Limited Warranty

(Valid only in U.S.A., Canada, Puerto Rico, and the Caribbean.)

Lutron will, at its option, repair or replace any unit that is defective in materials or manufacture within one year after purchase. For warranty service, return unit to place of purchase or mail to Lutron at 7200 Suter Rd., Coopersburg, PA 18036-1299, postage pre-paid.

THIS WARRANTY IS IN LIEU OF ALL OTHER EXPRESS WARRANTIES, AND THE IMPLIED WARRANTY OF MERCHANTABILITY IS LIMITED TO ONE YEAR FROM PURCHASE. THIS WARRANTY DOES NOT COVER THE COST OF INSTALLATION, REMOVAL OR REINSTALLATION, OR DAMAGE RESULTING FROM MISUSE, ABUSE, OR DAMAGE FROM IMPROPER WIRING OR INSTALLATION. THIS WARRANTY DOES NOT COVER INCIDENTAL OR CONSEQUENTIAL DAMAGES. LUTRON'S LIABILITY ON ANY CLAIM FOR DAMAGES ARISING OUT OF OR IN CONNECTION WITH THE MANUFACTURE, SALE, INSTALLATION, DELIVERY, OR USE OF THE UNIT SHALL NEVER EXCEED THE PURCHASE PRICE OF THE UNIT.

This warranty gives you specific legal rights, and you may have other rights which vary from state to state. Some states do not allow the exclusion or limitation of incidental or consequential damages, or limitation on how long an implied warranty may last, so the above limitations may not apply to you.

These products may be covered under the following U.S. patents: 4,992,709; D353,798; and corresponding foreign patents. U.S. and foreign patents pending. Lutron, Claro, and Maestro are registered trademarks and FASS and Satin Colors are trademarks of Lutron Electronics Co., Inc. NEC is a registered trademark of the National Fire Protection Association, Quincy, Massachusetts. © 2006 Lutron Electronics Co., Inc.

Lutron Electronics Co., Inc.
7200 Suter Road
Coopersburg, PA 18036-1299, U.S.A.
Made and printed in the U.S.A. 3/06 P/N 033-102 Rev. A

Lutron Technical Support Center

1-800-523-9466 24 hrs / 7 days www.lutron.com

Canopy Module Installation

1 Install fan(s).

- Install fan(s) according to manufacturer's instructions and check for proper operation.

2 Set fan speed.

- Set fan(s) to highest speed using pull chains.

3 Turn OFF power.

- Turn power OFF at circuit breaker (or remove fuse).

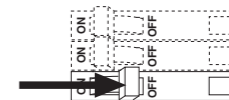

Note: Up to four ceiling fans can be controlled on one circuit. Follow steps 4-7 for each fan.

4 Disconnect fan.

- Remove canopy enclosure from ceiling fan mounting bracket.
- Leave any green ground wires connected as directed in fan manufacturer's instructions.
- Disconnect fan from remaining wiring in the ceiling.

Typical Wire Colors	
Fan	Black
Neutral	White

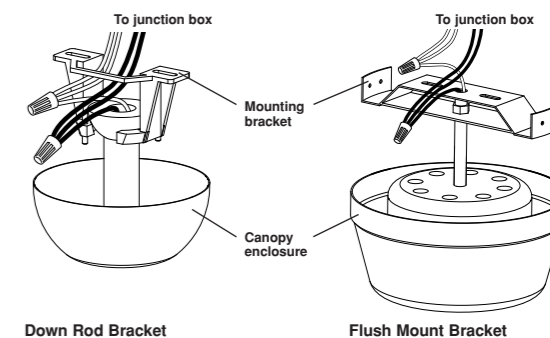

Important Wiring Information

When making wire connections, follow the recommended strip lengths and combinations for the supplied wire connectors (see wire connector bag). **Note:** All wire connectors provided are suitable for **copper wire only**. For aluminum wire, consult an electrician.

Wire Connectors:

Use to join 14 AWG or 12 AWG ground wire to 18 AWG Wall Control ground wire, and to join 18 AWG Canopy Module wire to 12, 14, 16 or 18 AWG wire.



Twist wire connector tight.

5 Connect Canopy Module(s).

- If you have questions about wiring, call the **Lutron Technical Support Center** at +1-800-523-9466.

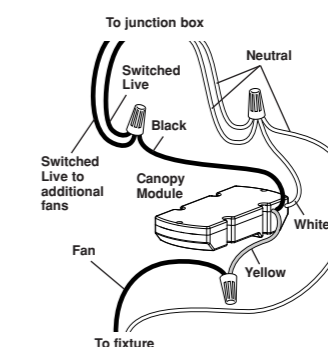

Wiring the Canopy Module (CM-FQ1):

Use wire connectors to join wires as indicated below and in the wiring diagram, and to cap any unused wires.

Canopy Module Wire:	Connects to:
White	Neutral wires in the junction box and to fan
Black	Switched Live wire(s) from Wall Control and to additional fan(s)
Yellow	Fan

6 Insert Canopy Module.

6a - Down Rod Bracket

- Do not install Canopy Module in ceiling.
- Slide Canopy Module into the ceiling fan mounting bracket.

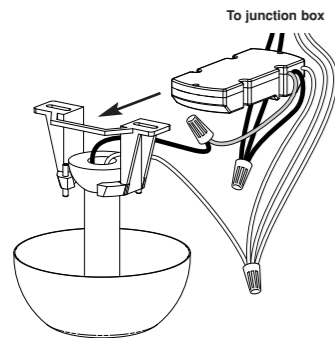

6b - Flush Mount Bracket

- Do not install Canopy Module in ceiling.
- Attach Canopy Module to bracket with a cable tie.
- Ensure cable tie does not come in contact with moving motor parts.
- Install cable tie through notches on Canopy Module. Pull tight and clip excess.

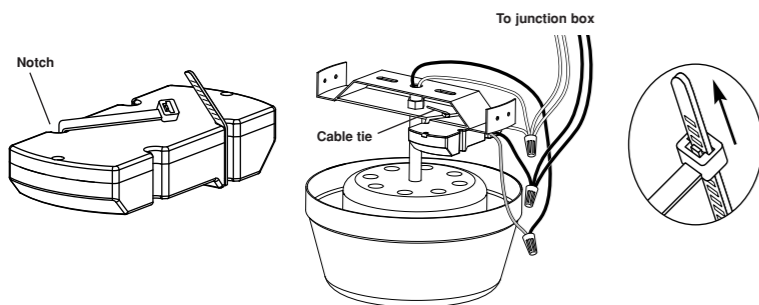

7 Attach canopy.

7a - Down Rod Bracket

- Check all wire connections.
- Tuck the wires into the junction box and/or canopy enclosure.
- Attach the canopy enclosure to the fan mounting bracket, taking care not to pinch any wires.

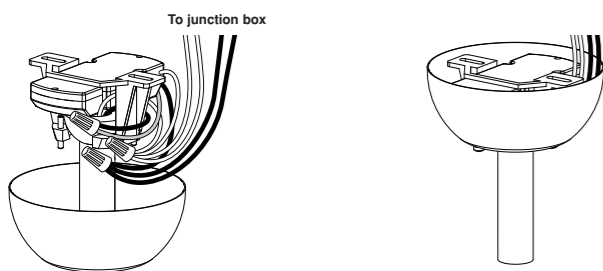

7b - Flush Mount Bracket

- Check all wire connections.
- Tuck the wires into the junction box and/or bracket.
- Ensure wires and/or wire connectors do not come in contact with moving motor parts.
- Attach the canopy enclosure to the fan mounting bracket, taking care not to pinch any wires.

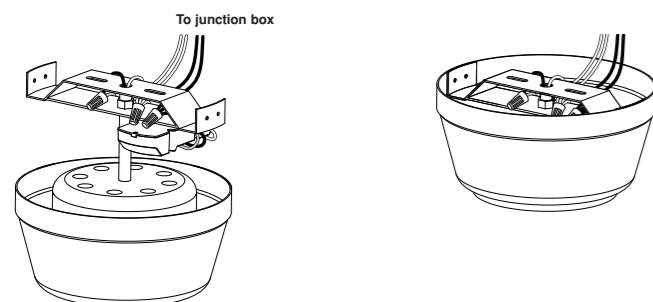

Control Installation

8 Remove original wallplate and switch.

- Remove the wallplate and switch mounting screws.
- Carefully remove switches from wall (do not remove wires).

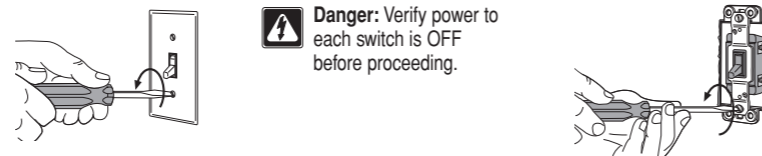

9 Identify the circuit type.

9a - Single-Location control

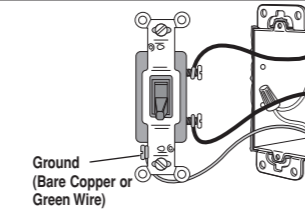

One switch controlling the fan(s).
This switch will be a single-pole. The switch will have insulated wires connected to two screws of the same color plus a green ground screw.

9b - Two-Location control

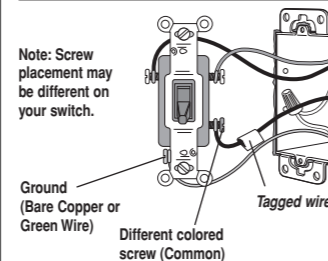

Two switches controlling the fan(s).
Both switches will be 3-way. Each switch will have insulated wires connected to three screws plus a green ground screw. One of these wires is connected to a screw of a different color (not green) or labeled COMMON. TAG this wire on both switches to identify when wiring.

9c - Three-Location control

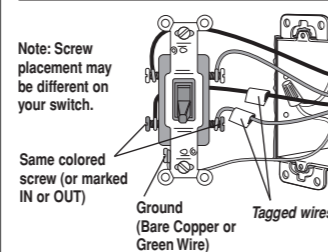

Three switches controlling the fan(s).
Two switches will be 3-way and one will be a 4-way. TAG the two 3-way switches as in the Two-Location diagram above. The 4-way switch will have insulated wires connected to four screws plus a green ground screw. TAG two insulated wires which are connected to same colored screws.

10 Identify switch wires.

Important Note:
Your wall switch may have two wires attached to the same screw (see illustrations below for examples). Tape these two wires together before disconnecting. When wiring, connect wires to new Controls the same way they were connected to the switch.

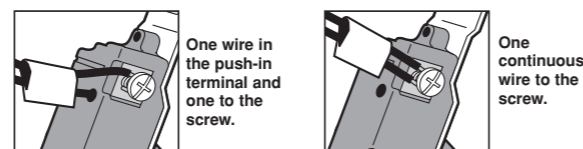

11 Disconnect switch wires.

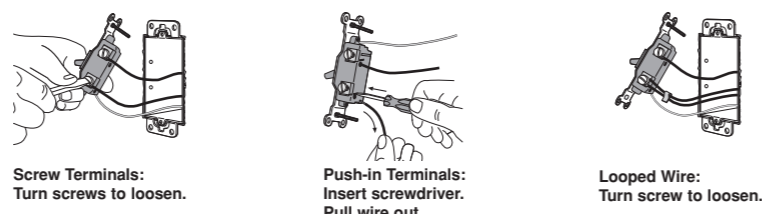

Important Wiring Information

Trim or strip wallbox wires to the length indicated by the strip gauge on the back of the control

Push-in Terminals: Insert wires fully.
NOTE: Push-in terminals are for use with 14 AWG solid copper wire only. DO NOT use stranded or twisted wire.

OR

Screw Terminals: Tighten securely.
Screw terminals are for use with 12 or 14 AWG solid copper wire only. DO NOT use stranded or twisted wire.

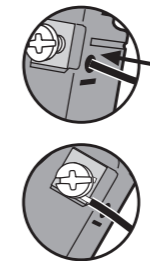

12 Connect Control(s).

- For installations involving more than one control in a wallbox, refer to Multigang Installations before beginning.
- Only one Wall Control (MA-FQ4M) can be used with up to 2 Accessory Controls (MA-AFQ4).

12a - Single-Location control

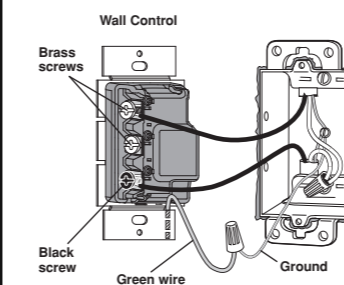

Wiring the Wall Control (MA-FQ4M):

- Connect either of the wires removed from the switch to the **black** screw terminal on the Wall Control.
- Connect the remaining wire removed from the switch to one of the **brass** screw terminals on the Wall Control.
- Tighten the remaining **brass** screw terminal on the Wall Control. It is not used in a single-pole circuit.
- Use wire connectors to connect the **green** ground wire on the Wall Control to the **bare copper** or **green** ground wire in the wallbox (see Important Note 3), and to **cap any unused wires**.

Reference Wiring Diagram

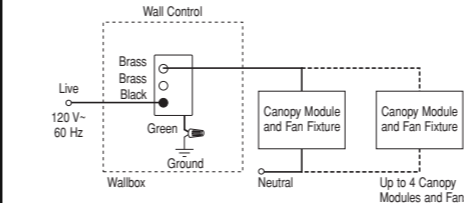

12b - Two-Location control

One location will be replaced with a Wall Control (MA-FQ4M) and the other with an Accessory Control (MA-AFQ4).

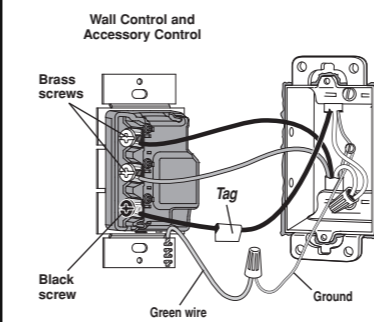

Wiring the Wall Control and Accessory Control:

- Connect the tagged wire removed from the switch to the **black** screw terminal on the Control.
- Connect one of the remaining wires removed from the switch to one of the **brass** screw terminals on the Control.
- Connect the remaining wire removed from the switch to the remaining **brass** screw terminal on the Control.
- Use wire connectors to connect the **green** ground wire on the Control to the **bare copper** or **green** ground wire in the wallbox (see Important Note 3), and to **cap any unused wires**.

Reference Wiring Diagram

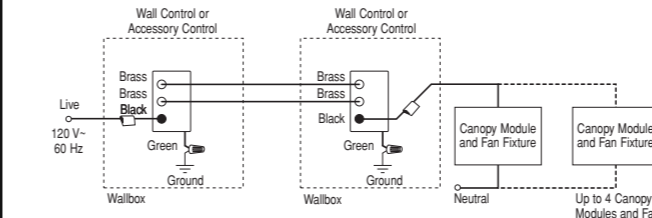

12c - Three-Location control

One location will be replaced with a Wall Control (MA-FQ4M) and the other two with Accessory Controls (MA-AFQ4).

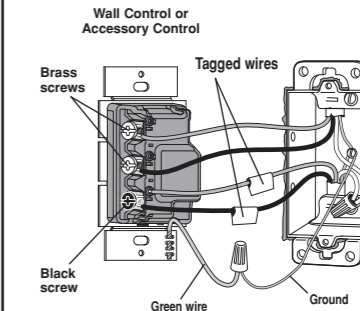

Replace the 4-way switch

- Note:** 4-way switch may be replaced with either a Wall Control or an Accessory Control
- Connect both of the tagged wires removed from the 4-way switch to the **black** screw terminal on the Control (one wire to the screw and the other to the push-in terminal).
 - Connect one of the remaining wires removed from the switch to one of the **brass** screw terminals on the Control.
 - Connect the remaining wire removed from the switch to the remaining **brass** screw terminal on the Control.
 - Use wire connectors to connect the **green** ground wire on the Control to the **bare copper** or **green** ground wire in the wallbox (see Important Note 3), and to **cap any unused wires**.

Replace the two 3-way switches
Follow Step 12b - Two-Location control.

Reference Wiring Diagram

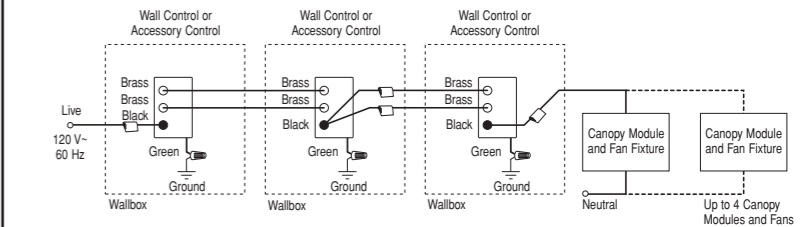

13 Mount Control(s) to wallbox.

- Form wires carefully into the wallbox, mount and align the Control(s).
- Install wallplate(s).



14 Turn ON power.

- Do not turn on power until Wall Control, Accessory Control(s) and Canopy Module(s) have been installed and wired.
- Turn power ON at circuit breaker (or replace fuse).

Warning: Fan(s) will return to full speed when power is restored. Clean up any tools or ladders near the fan(s) first.

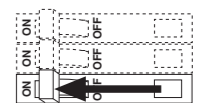

15 Activate system.

- Pull out the Front Accessible Service Switch (FASS) at the bottom of the Wall Control, wait 10 seconds, then push it back in.
- The LEDs will cycle for up to 30 seconds.
- If installing more than one Wall Control/Canopy Module system, activate one at a time with FASS pushed in on all other systems.
- Accessory Controls do not require activation.

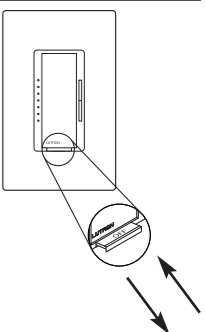

16 Recommended - Disconnect pull chains.

- Disconnect pull chain extensions to prevent fan speed from being adjusted at the fan(s).