









HIGH TEMPERATURE HIGH BAY PERFORMANCE IN EXTREME ENVIRONMENTS

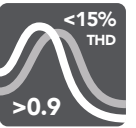

 120-277V or 347-480V VOLTAGE	 0-10V DIM OPTIONAL 10V DIM	 150 LPW EFFICACY	 -40°F TO 176°F OPERATING TEMP	 IP67 RATED INGRESS PROTECTION	 <15% THD >0.9 PWR FACTOR/THD	 70+ CRI	 110° 60° OPTIONAL BEAM ANGLE	 L70 >50,000 RATED LIFE	 YEAR 5 WARRANTY
--	---	---	---	---	--	--	---	---	--

go to high bay extremes



- 176°F ambient rating, suitable for foundries, steel mills, smelters and other demanding applications.
- IP67 rated for high resistance to dust and liquids.
- Super high efficacy LEDs and driver >22,000 lumens @150 LPW.
- Hanger ring, pendant or junction box mounting options.

← high quality
tempered glass
& aluminum



PART #	UPC	REPLACES	WATTAGE	LUMENS	LPW	CCT (K)	DLC PRODUCT CODE
RP-HTHB-21L-50K-110	844006011246	400W HID	150W	22500	150	5000K	PLTK1DTN6KWH
RP-HTHB-21L-50K-110-HV	844006011253	400W HID	150W	22500	150	5000K	PLEOJAT3ZZ5



RemPhos by Light Efficient Design
lighting on target

FOR PRODUCT INFO ("LED" MODEL #) CONTACT.....Light Efficient Design • 188 S. Northwest Highway • Cary, IL 60013 • 847.380.3540 • led-llc.com
FOR PRODUCT INFO ("RP" MODEL #) CONTACT.....RemPhos by Light Efficient Design • 30 Log Bridge Road, Building 200 • Middleton, MA 01949 • 877.997.3674 • remphos.com

HIGH TEMPERATURE HIGH BAY PERFORMANCE IN EXTREME ENVIRONMENTS



ACCESSORIES

MODEL #	DESCRIPTION
RP-HTHB-REFLECTOR-60DEG	60° Reflector for High Temp High Bay
RP-HTHB-JBOX	Junction Box for High Temp High Bay
RP-HTHB-JBOXBRACKET	JBox Bracket for High Temp High Bay
RP-HTHB-TRUNBRACKET	Trunnion Bracket for High Temp High Bay

GENERAL SPECIFICATIONS

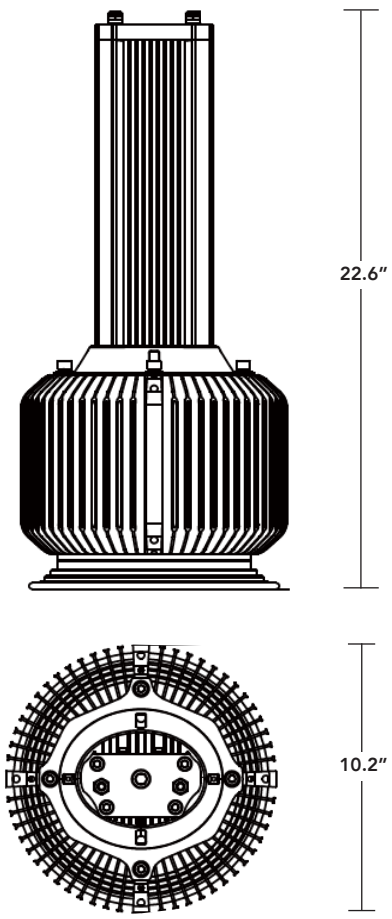

ELECTRICAL

SPECIFICATION	RP-HTHB-21L-50K	RP-HTHB-21L-50K-HV
Rated power	150W	150W
Input Voltage	120-277V	347-480V
Input Frequency	50/60 Hz	50/60 Hz
Power Factor	>0.95	>0.95
Dimmable	0/1 ~ 10V	0/1 ~ 10V

OPTICAL

SPECIFICATION	RP-HTHB-21L-50K	RP-HTHB-21L-50K-HV
Lumen Output	22500 Lm	22500 Lm
Lumens per Watt	150 Lm/W	150 Lm/W
Beam Angle	110° STD, 60° Optional	110° STD, 60° Optional
CCT	5000K	5000K
CRI	>70	>70

ENVIRONMENTAL

SPECIFICATION	RP-HTHB-21L-50K	RP-HTHB-21L-50K-HV
Ambient Operating Temperature	-40°F to +176°F	-40°F to +176°F
Ambient Operating Humidity	10% ~ 90% RH	10% ~ 90% RH

MECHANICAL

SPECIFICATION	RP-HTHB-21L-50K	RP-HTHB-21L-50K-HV
Housing Material	Aluminum	Aluminum
Lens Material	Tempered Glass	Tempered Glass
Mounting Options	Hanging Hook/Pendant/Junction Box	Hanging Hook/Pendant/Junction Box

COMPLIANCE

SPECIFICATION	RP-HTHB-21L-50K	RP-HTHB-21L-50K-HV
UL1598 for USA and Canada	✓	✓
CE / ROHS	✓	✓
DLC 4.2 / FCC	✓	✓
IP67	✓	✓

PRODUCT WEIGHT

SPECIFICATION	RP-HTHB-21L-50K	RP-HTHB-HV-XXL-50K
Net Weight	11.0kg/22.3lbs.	11.0kg/22.3lbs.
Gross Weight	12.2g/26.9lbs.	12.2g/26.9lbs.



FOR PRODUCT INFO ("LED" MODEL #) CONTACT.....Light Efficient Design • 188 S. Northwest Highway • Cary, IL 60013 • 847.380.3540 • led-llc.com
 FOR PRODUCT INFO ("RP" MODEL #) CONTACT.....RemPhos by Light Efficient Design • 30 Log Bridge Road, Building 200 • Middleton, MA 01949 • 877.997.3674 • remphos.com

02.28.19 Information is subject to change without notice.

HIGH TEMPERATURE HIGH BAY PERFORMANCE IN EXTREME ENVIRONMENTS



MOUNTING OPTIONS



HK02 HOOK



PENDANT



JUNCTION BOX NPT 3/4"

PHOTOMETRICS

60 Degree

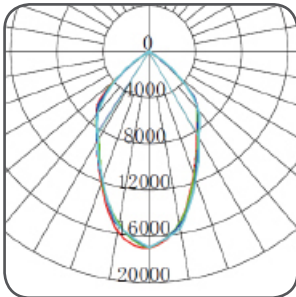

— C0/180,61.1° — C60/240,62.7°
 — C30/210,61.6° — C90/270,62.2°

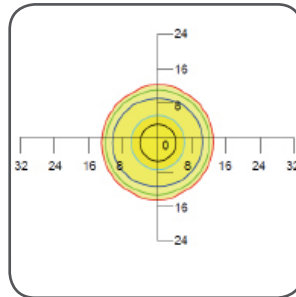

MOUNTING HEIGHT 33' (10M), 0 TILT

Illumination-60 Degree		
6m	7.1m	255.3Lux
8m	9.4m	143.7Lux
10m	11.8m	91.9Lux
12m	14.2m	63.8Lux
15m	17.7m	40.9Lux
Height	Diameter	Eavg

FLUX OUT: 10424 LM

110 Degree

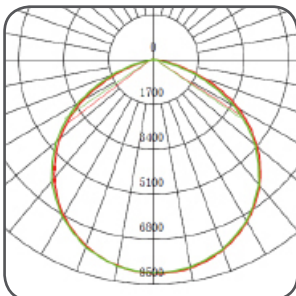

— V 0.0DEG PLAN, 111.8
 — H 0.0DEG PLAN, 112.2

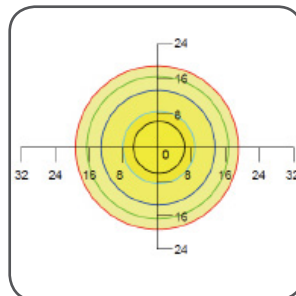

MOUNTING HEIGHT 33' (10M), 0 TILT

Illumination-100 Degree		
6m	17.7m	85.8Lux
8m	23.6m	48.2Lux
10m	39.4m	30.9Lux
12m	35.3m	21.4Lux
15m	44.1m	13.7Lux
Height	Diameter	Eavg

FLUX OUT: 21319 LM

RemPhos by Light Efficient Design
 lighting on target

FOR PRODUCT INFO ("LED" MODEL #) CONTACT.....Light Efficient Design • 188 S. Northwest Highway • Cary, IL 60013 • 847.380.3540 • led-llc.com
 FOR PRODUCT INFO ("RP" MODEL #) CONTACT.....RemPhos by Light Efficient Design • 30 Log Bridge Road, Building 200 • Middleton, MA 01949 • 877.997.3674 • remphos.com

02.28.19 Information is subject to change without notice.