

### Features

- Patented K-joint installation ensures consistent trim appearance, regardless of variability in valve rough-in
- Trim requires valve to complete
- KOHLER finishes resist corrosion and tarnishing.

### Required Products/Accessories

- K-2972-KS 1/2" Thermostatic Mixing Valve  
or  
K-2975-KS 3/4" Thermostatic Mixing Valve



ADA CSA B651 OBC

### Codes/Standards







ASME A112.18.1/CSA B125.1  
ADA  
ICC/ANSI A117.1  
CSA B651  
OBC

### KOHLER® Faucet Lifetime Limited Warranty

See website for detailed warranty information.

### Available Colors/Finishes

*Color tiles intended for reference only.*

Color	Code	Description
	CP	Polished Chrome
	SN	Vibrant® Polished Nickel
	PB	Vibrant® Polished Brass
	BN	Vibrant® Brushed Nickel
	BV	Vibrant® Brushed Bronze
	2BZ	Oil-Rubbed Bronze

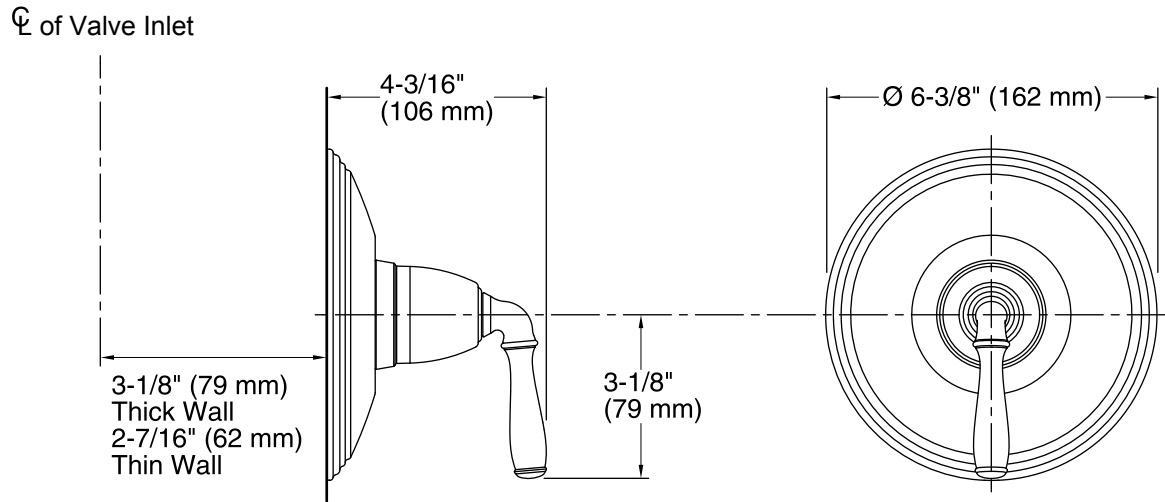

**Technical Information**

All product dimensions are nominal.

**Notes**

ADA, OBC, CSA B651 compliant when installed to the specific requirements of these regulations.