

Features

- Advanced spray engine with easy-grip sprayface provides four alternate experiences: wide coverage, massage, soft aerated, and reduced-flow spray.
- MasterClean™ sprayface is easy to clean.
- Ergonomic sprayhead pivots to allow precise adjustment for a targeted hydromassage.
- Requires shower hose (sold separately).
- Coordinates with Purist and Stillness faucets and accessories.
- 2.5 gal/min (9.5 l/min) flow rate.

Material

- KOHLER finishes resist corrosion and tarnishing.

Installation

- Bracket or sidebar required for wall-mount installation.
- Deck-mount holder required for deck-mount installation.

Recommended Replacements

- This product is replaced by 22166.

Required Products/Accessories

K-8593 72" Shower Hose

or

K-9514 60" Shower Hose



ADA

CSA B651

OBC

Codes/Standards







ASME A112.18.1/CSA B125.1
DOE - Energy Policy Act 1992
ADA
ICC/ANSI A117.1
CSA B651
OBC

KOHLER® Faucet Lifetime Limited Warranty

See website for detailed warranty information.

Available Colors/Finishes

Color tiles intended for reference only.

Color	Code	Description
	CP	Polished Chrome
	SN	Vibrant® Polished Nickel
	AF	Vibrant® French Gold
	PGD	Vibrant® Moderne Polished Gold
	BGD	Vibrant® Moderne Brushed Gold
	BN	Vibrant® Brushed Nickel
	BV	Vibrant® Brushed Bronze

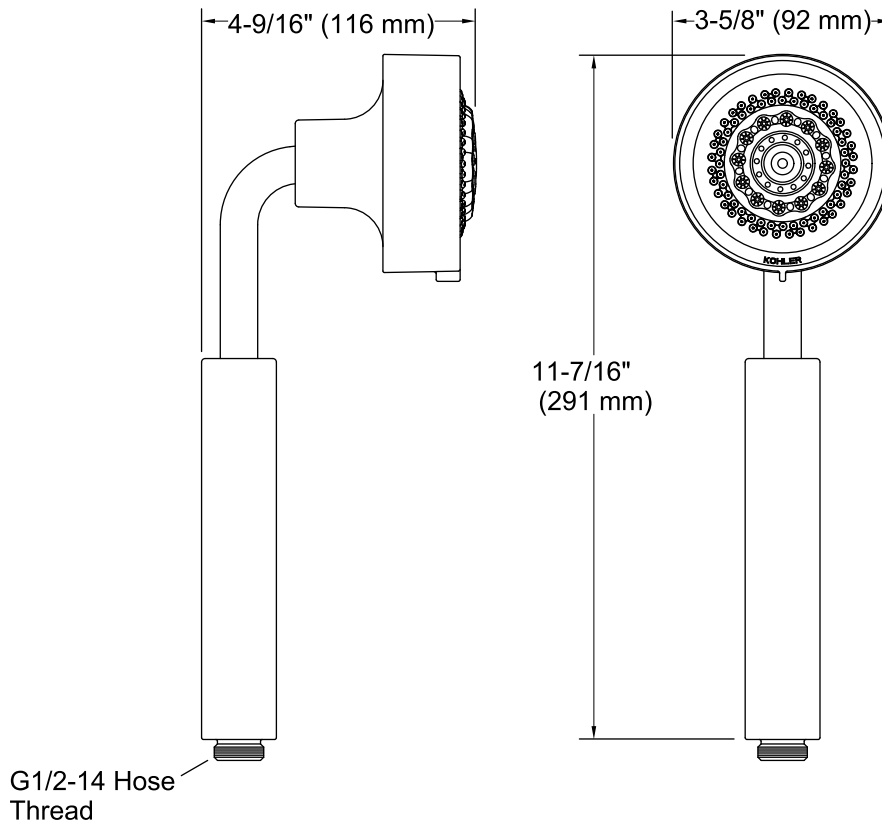

Technical Information

All product dimensions are nominal.

Drain included: No

Notes

For use with automatic compensating valves rated at 2.5 gal/min (9.5 l/min) or less.

Install this product according to the installation guide.

Plumbing codes require an atmospheric vacuum breaker (such as Kohler Model K-9660) be installed in-line with handshowers. Please consult with local plumbing officials.

ADA, OBC, CSA B651 compliant when installed to the specific requirements of these regulations.