



Memoirs®
 48" x 34" Shower Base
K-9547



Features

- Textured floor pattern.
- Corner installation.
- Durable acrylic construction.
- Left drain.
- Coordinates with other products in the Memoirs collection.

Recommended Products/Accessories

K-9132 Shower Drain



Codes/Standards











ASME A112.19.1/CSA B45.2
 CSA B45.5/IAPMO Z124
 ASTM E162
 ASTM E662
 Greenguard UL 2818 - Gold

**KOHLER® Plastic Baths and Receptors
 Lifetime Limited Warranty**

See website for detailed warranty information.

Available Colors/Finishes

Color tiles intended for reference only.

Color	Code	Description
	0	White
	96	Biscuit
	47	Almond
	NY	Dune
	95	Ice™ Grey
	G9	Sandbar
	33	Mexican Sand™
	K4	Cashmere
	58	Thunder™ Grey
	7	Black Black™

1-800-4KOHLER (1-800-456-4537)

Kohler Co. reserves the right to make revisions without notice to product specifications.

For the most current Specification Sheet, go to www.kohler.com.

4-26-2019 02:51 - US/CA

THE BOLD LOOK
 OF **KOHLER**®

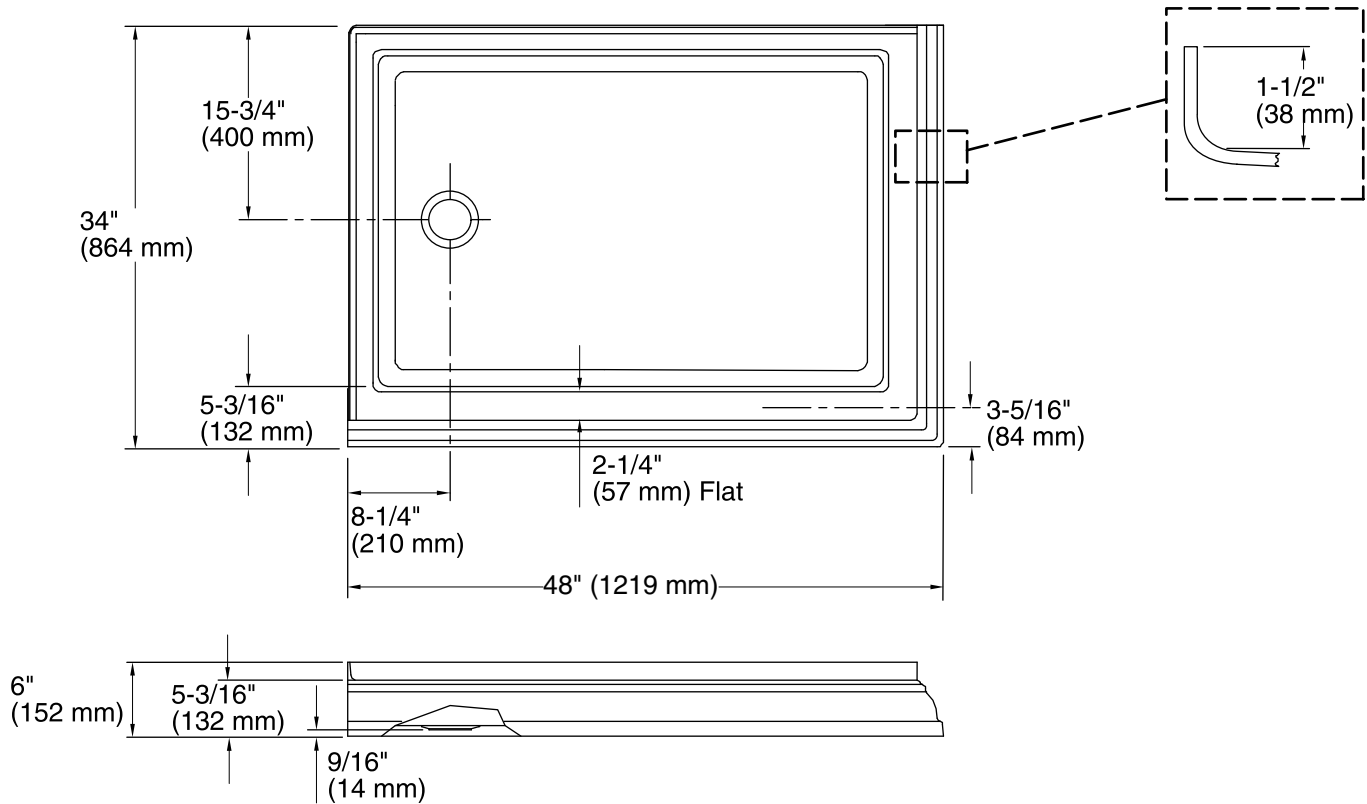

Technical Information

All product dimensions are nominal.

Installation:	Corner
Drain location:	Left
Weight:	36 lbs (16.3 kg)
Minimum floor load:	20 lbs/ft ² (97.6 kg/m ²)

Notes

- Measure your actual product for rough-in details.
- Install this product according to the installation instructions.
- Shimming may be required to level the fixture.
- Shimming between stud frame and fixture may be required.
- Stud opening tolerance is + 1/4" (6 mm), - 0" (0 mm).