



Air Gap Body with Cover K-9110

Features

- Solid-brass cap offers years of reliable performance.
- Durable plastic body.
- Includes valve body and cover.

Material

- KOHLER finishes resist corrosion and tarnishing.

Recommended Products/Accessories

K-23723 Faucet cleaner



Codes/Standards









None Applicable

KOHLER® Faucet Lifetime Limited Warranty

See website for detailed warranty information.

Available Colors/Finishes

Color tiles intended for reference only.

Color	Code	Description
	CP	Polished Chrome
	SN	Vibrant® Polished Nickel
	PB	Vibrant® Polished Brass
	G	Brushed Chrome
	BN	Vibrant® Brushed Nickel
	VS	Vibrant® Stainless
	BV	Vibrant® Brushed Bronze
	2BZ	Oil-Rubbed Bronze
	BL	Matte Black

1-800-4KOHLER (1-800-456-4537)

Kohler Co. reserves the right to make revisions without notice to product specifications.
For the most current Specification Sheet, go to www.kohler.com.

THE BOLD LOOK
OF **KOHLER**®

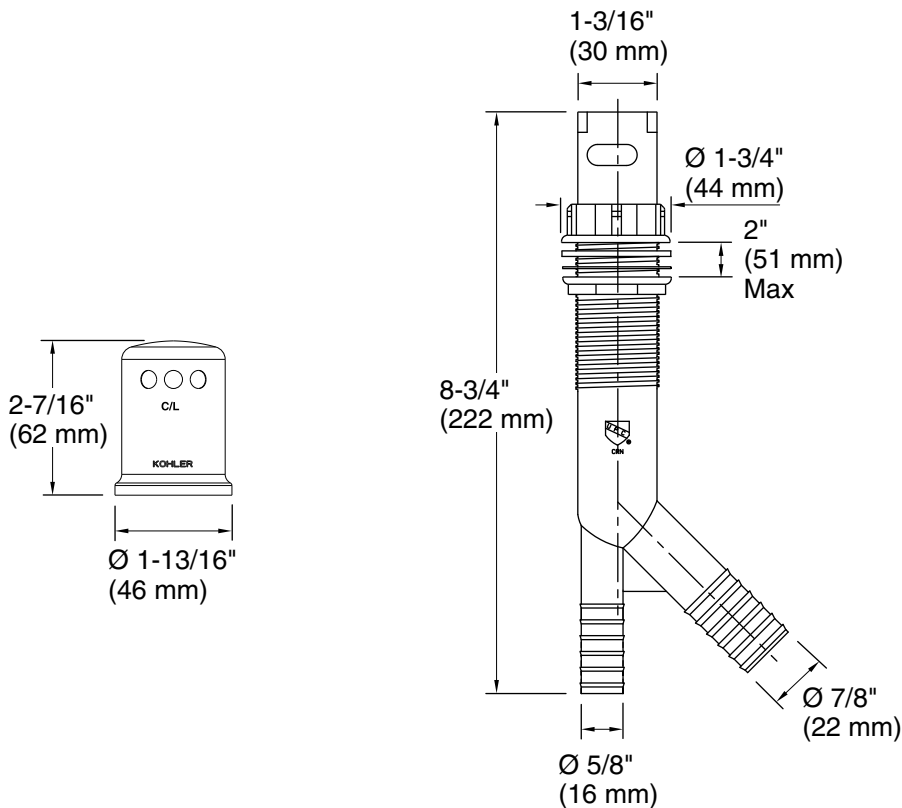

Technical Information

All product dimensions are nominal.

Material: Brass, Plastic

Notes

Install this product according to the installation guide.