

Features

- 6 hydromassage jets can be individually adjusted for water flow and direction.
- Variable-speed pump for adjusting massage intensity.
- Built-in heater.
- Electronic keypad.
- Safeguard slip-resistant surface on bath floor.
- End drain.
- Under-mountable

Material

- KOHLER® enameled cast iron.

Hydrotherapy

- Whirlpool

Installation

- Drop-in or under-mount.

Additional Hydrotherapy Options

- Soaking Bath - K-850-0
- BubbleMassage air bath - K-852-G0
- Whirlpool - K-852-H2

Required Products/Accessories

K-7169-AF 1-1/2" Contoured Pop-up Drain
K-9696 Whirlpool 6-Jet Trim Kit

Recommended Products/Accessories

K-1179 Vinyl Tiling-in Bead
K-1703 Whirlpool Remote Control
K-586 Under-Mount Installation Kit
K-1172 Adjustable feet
K-1491 Bath/Whirlpool Pillow
K-1601 Bath/Whirlpool Footstop
K-9497 2-1/2" Keypad Trim
K-702200-G54 Frameless Sliding Bath Door
K-702200-G73 Frameless Sliding Bath Door
K-702200-L Frameless Sliding Bath Door
K-702205-L Frameless Sliding Bath Door



ADA

Codes/Standards

ASME A112.19.1/CSA B45.2
ASME A112.19.7/CSA B45.10
ASTM F462
UL 1795
CSA C22.2 No. 218.2
ADA
ICC/ANSI A117.1









KOHLER® Enameled Cast Iron Bath and Shower Base Lifetime Limited Warranty

KOHLER® Hydrotherapy Components Five-Year Limited Warranty

See website for detailed warranty information.

Available Colors/Finishes

Color tiles intended for reference only.

Color	Code	Description
	0	White
	96	Biscuit
	47	Almond
	NY	Dune
	95	Ice™ Grey
	G9	Sandbar
	33	Mexican Sand™
	K4	Cashmere
	58	Thunder™ Grey

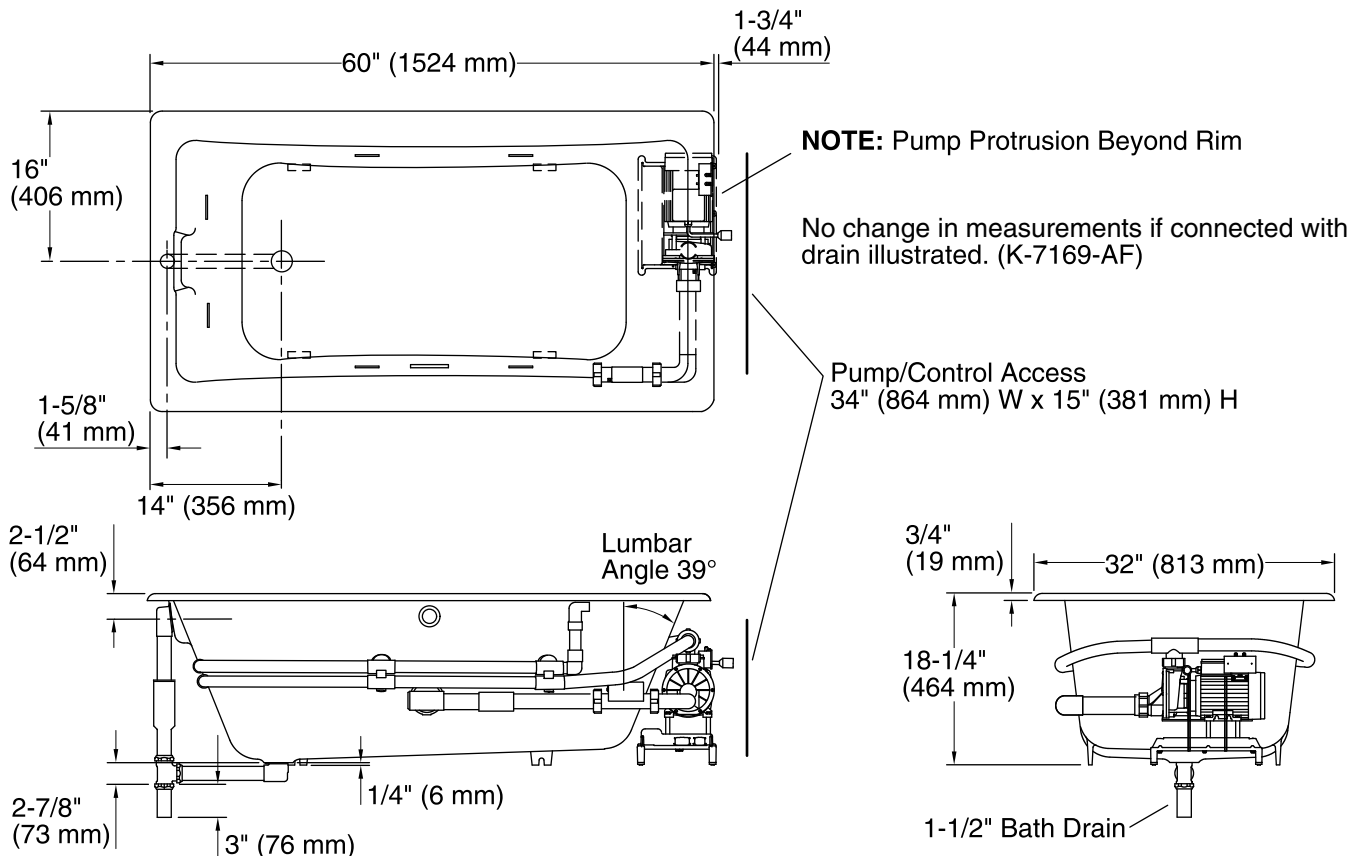

Required Electrical Service

One dedicated circuit required, protected with Class A Ground-Fault Circuit-Interrupter (GFCI). Outside North America, this device may be known as a Residual Current Device (RCD).

Pump: 240 V, 20 A, 50/60 Hz

Technical Information

All product dimensions are nominal.

Installation:	Drop-in, Under-mount
Drain location:	End
Basin area, bottom:	40-1/2" x 20" (1029 mm x 508 mm)
Basin area, top:	52-3/4" x 24" (1340 mm x 610 mm)
Weight:	290 lbs (131.5 kg)
Minimum floor load:	60 lbs/ft ² (292.9 kg/m ²)
Water depth:	13-5/8" (346 mm)
Water capacity:	60 gal (227.1 L)
Cutout:	Drop-in, 58-1/2" x 30-1/2" (1486 mm x 775 mm)
Template:	Under-mount, K-586, required, not included
Electrical component rating:	Pump: 240 V, 11 A, 1500 W

Notes

Measure your actual product for rough-in details. Install this product according to the installation instructions.

The hot water supply should be 70% of the capacity of the bath or greater. Installations will vary.

Kit is required for under-mount installations (sold separately).

Cast iron whirlpools are extremely heavy, making some drop-in installations difficult. Splitting the deck/surround is recommended if installing into a deck.

ADA compliant when installed to the specific requirements of these regulations.