

### Features

- Integral apron.
- Safeguard® slip-resistant surface on bath floor.
- Coordinates with other products in the Memoirs collection.

### Material

- KOHLER® enameled cast iron.

### Installation

- Right drain.
- Alcove.

### Recommended Products/Accessories

K-7161-AF 1-1/2" adjustable pop-up drain above- or through-floor

K-7259 Brass toe tap bath drain

K-702200-G73 Frameless Sliding Bath Door

K-702200-L Frameless Sliding Bath Door

K-706000-D3 Frameless Sliding Bath Door

K-706000-L Frameless Sliding Bath Door

K-706003-L Frameless Sliding Bath Door

K-706004-D3 Frameless Sliding Bath Door

K-706004-L Frameless Sliding Bath Door

K-706007-L Frameless Sliding Bath Door

K-23726 Drain treatment

K-23725 Cast iron cleaner



ADA

### Codes/Standards

ASME A112.19.1/CSA B45.2

ASTM F462

ADA





ICC/ANSI A117.1

### KOHLER® Enameled Cast Iron Bath and Shower Base Lifetime Limited Warranty

See website for detailed warranty information.

### Available Colors/Finishes

*Color tiles intended for reference only.*

| Color   | Code | Description |
|---|------|-------------|
|  | 0    | White       |
|  | 96   | Biscuit     |
|  | NY   | Dune        |
|  | G9   | Sandbar     |
|  | K4   | Cashmere    |

No change in measurements if connected with drain illustrated. (K-7161-AF)

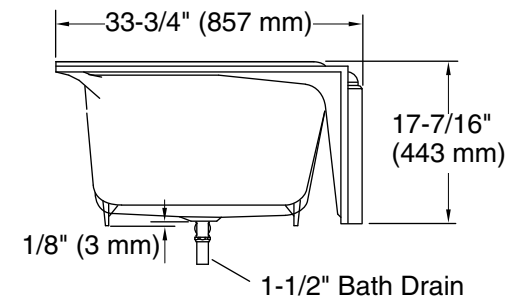
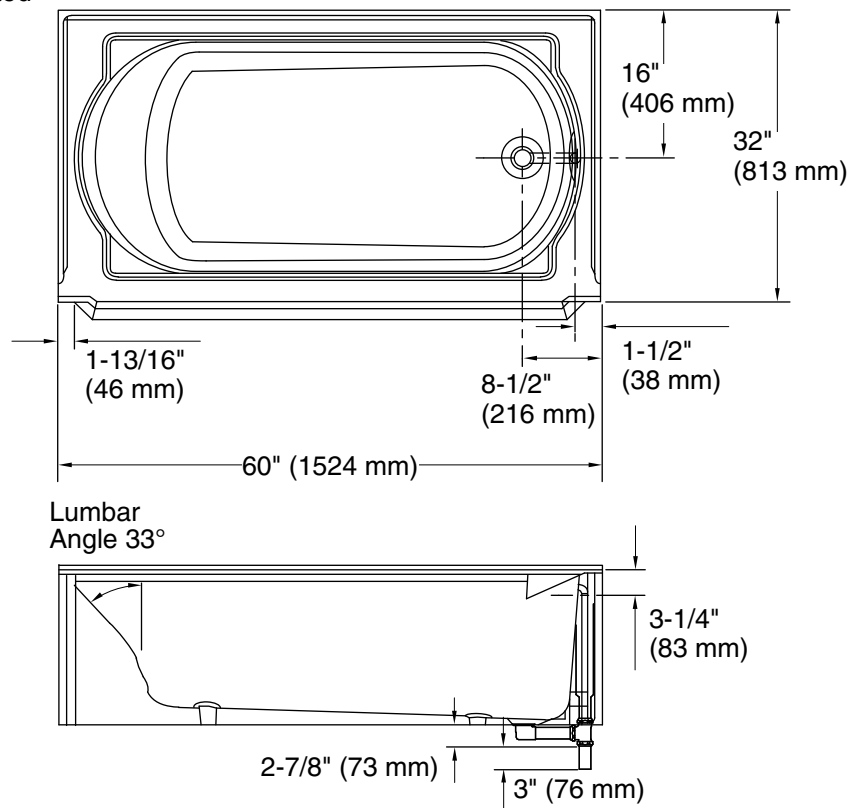

## Technical Information

All product dimensions are nominal.

|                        |   |
|------------------------|---|
| Installation:          | Three-wall alcove                                 |
| Drain location:        | Right   |
| Basin area, bottom:    | 45" x 23" (1143 mm x 584 mm)                      |
| Basin area, top:       | 54" x 25" (1372 mm x 635 mm)                      |
| Weight:                | 390 lbs (176.9 kg)                                |
| Minimum floor load:    | 61 lbs/ft <sup>2</sup> (297.8 kg/m <sup>2</sup> ) |
| Water depth:           | 11-5/8" (295 mm)                                  |
| Water capacity:        | 52 gal (196.8 L)                                  |
| Minimum flat for door: | 2" (51 mm)  |

## Notes

Measure your actual product for rough-in details.

Install this product according to the installation instructions.

The hot water supply should be 70% of the capacity of the bath or greater. Installations will vary.

ADA compliant when installed to the specific requirements of these regulations.