

Features

- Two-function pull-down sprayhead with touch-control allows you to switch from stream to spray.
- Ceramic disc valves exceed industry longevity standards, ensuring durable performance for life.
- High-arch gooseneck spout and 360-degree spout rotation offer superior clearance for filling pots and cleaning.
- Temperature memory allows faucet to be turned on and off at the temperature set during prior usage.
- 1.5 gal/min (5.7 l/min) maximum flow rate [max at 60 psi (4.14 bar)]

Material

- Premium metal construction.
- KOHLER finishes resist corrosion and tarnishing.

Installation

- Single- or three-hole installation (escutcheon included).
- Flexible supply lines simplify installation.



ADA CSA B651

Codes/Standards







ASME A112.18.1/CSA B125.1
NSF/ANSI 61
NSF/ANSI 372
DOE - Energy Policy Act 1992
California Energy Commission (CEC)
ADA
ICC/ANSI A117.1
CSA B651

KOHLER® Faucet Lifetime Limited Warranty

See website for detailed warranty information.

Available Colors/Finishes

Color tiles intended for reference only.

Color	Code	Description
	CP	Polished Chrome
	SN	Vibrant® Polished Nickel
	BN	Vibrant® Brushed Nickel
	VS	Vibrant® Stainless
	BV	Vibrant® Brushed Bronze
	BRZ	Oil-Rubbed Bronze
	2BZ	Oil-Rubbed Bronze

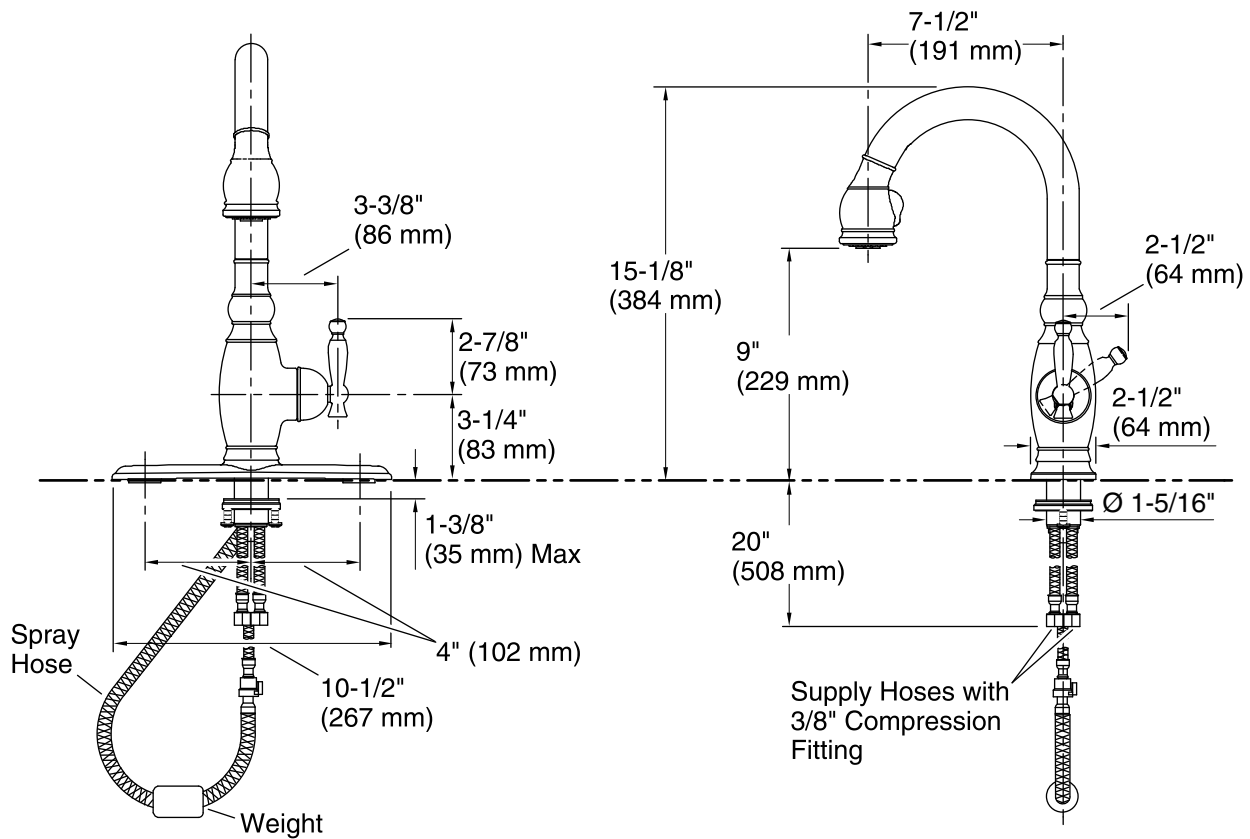

Technical Information

All product dimensions are nominal.

Faucet:

Flow rate: 1.5 gal/min (5.7 l/min)

Pressure: 60 psi (4.1 bar)

Notes

Install this product according to the installation guide.

ADA, CSA B651 compliant when installed to the specific requirements of these regulations.