

Features

- Brass construction.
- Brass valve bodies.
- Quarter-turn washerless ceramic disc valves.
- Single-hole mounting.
- Right-side lever handle.
- Contemporary styling.
- 8-3/4" (222 mm) high-arch rotating spout.
- 4-7/8" (124 mm) spout reach.
- 1.6 gal/min (6.1 l/min) maximum flow rate.



ADA CSA B651

Codes/Standards







ASME A112.18.1/CSA B125.1
All applicable US Federal and State material regulations
DOE - Energy Policy Act 1992
California Energy Commission (CEC)
ADA
ICC/ANSI A117.1
CSA B651

KOHLER® Faucet Lifetime Limited Warranty

See website for detailed warranty information.

Available Colors/Finishes

Color tiles intended for reference only.

Color	Code	Description
	CP	Polished Chrome
	G	Brushed Chrome
	BN	Vibrant® Brushed Nickel
	VS	Vibrant® Stainless
	BV	Vibrant® Brushed Bronze
	BL	Matte Black

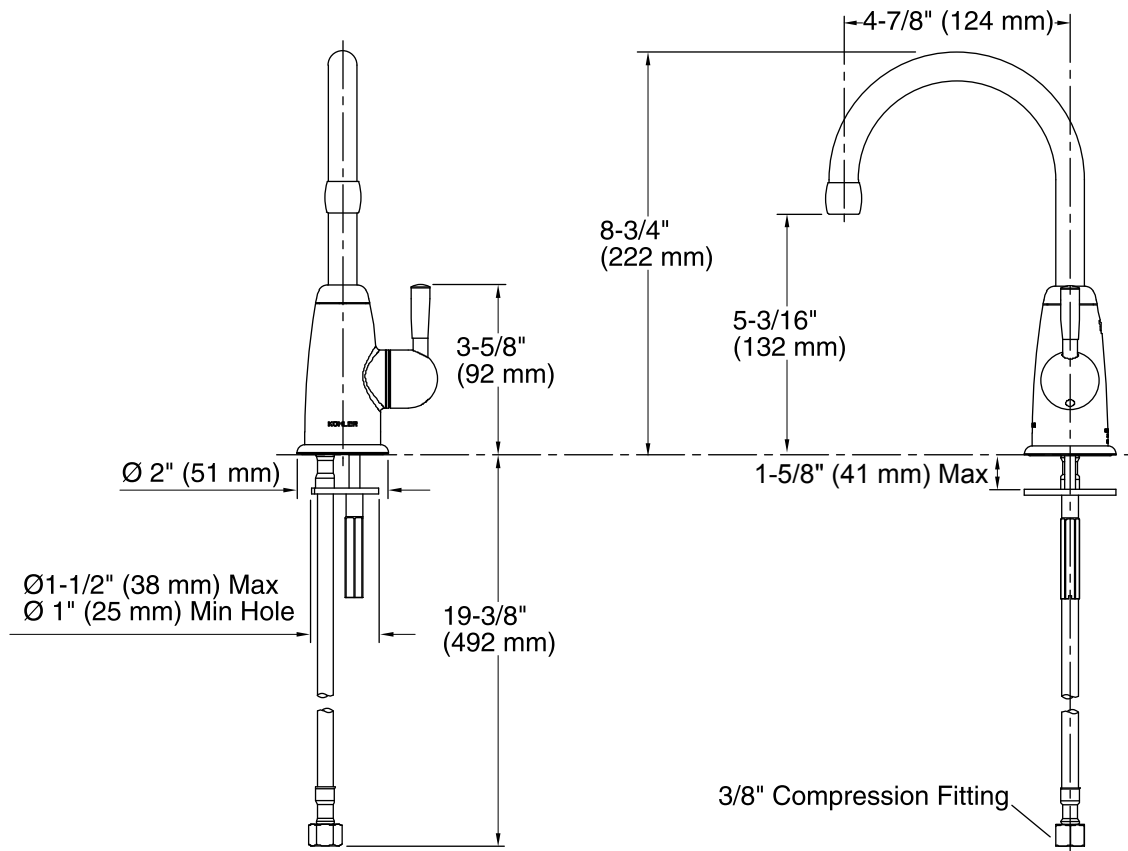

Technical Information

All product dimensions are nominal.

Faucet:

Flow rate: 1.6 gal/min (6.1 l/min)

Spout:

Spout reach: 4-7/8" (124 mm)

Notes

Install this product according to the installation guide.

NOTICE: Do not use this product with instant hot water systems or reverse osmosis (RO) filtration systems. Product damage will result.

ADA, CSA B651 compliant when installed to the specific requirements of these regulations.