

### Features

- 33-inch minimum base cabinet width.
- Double equal bowls.
- 9-inch depth.
- Single faucet hole with one accessory hole to the right.
- Smart Divide® features a lower bowl divider that increases workspace and versatility.

### Material

- KOHLER® enameled cast iron.

### Installation

- Top-mount

### Recommended Products/Accessories

K-9000 P-Trap  
K-6377 Sponge Caddy  
K-6378 Kitchen Brush Caddy  
K-6379 Kitchen Squeegee  
K-6382 Disinfecting Wipes Dispenser  
K-6383 Soap Dispenser  
K-8618 Paper Towel Holder  
K-8619 Flexible Kitchen Mat  
K-8624 Dish Scraper  
K-5180 Right-Bowl Sink Rack  
K-5182 Left-Bowl Sink Rack  
K-8801 Sink Strainer  
K-8799 Sink Strainer

### Optional Products/Accessories

K-6545 Sponge Caddy



### Codes/Standards









ASME A112.19.1/CSA B45.2

### KOHLER® Enameled Cast Iron Kitchen Sink Lifetime Limited Warranty

See website for detailed warranty information.

### Available Colors/Finishes

*Color tiles intended for reference only.*

Color	Code	Description
	0	White
	FF	Sea Salt™
	96	Biscuit
	47	Almond
	FD	Cane Sugar™
	95	Ice™ Grey
	K4	Cashmere
	KA	Black 'n Tan
	7	Black Black™

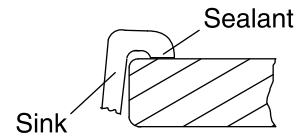
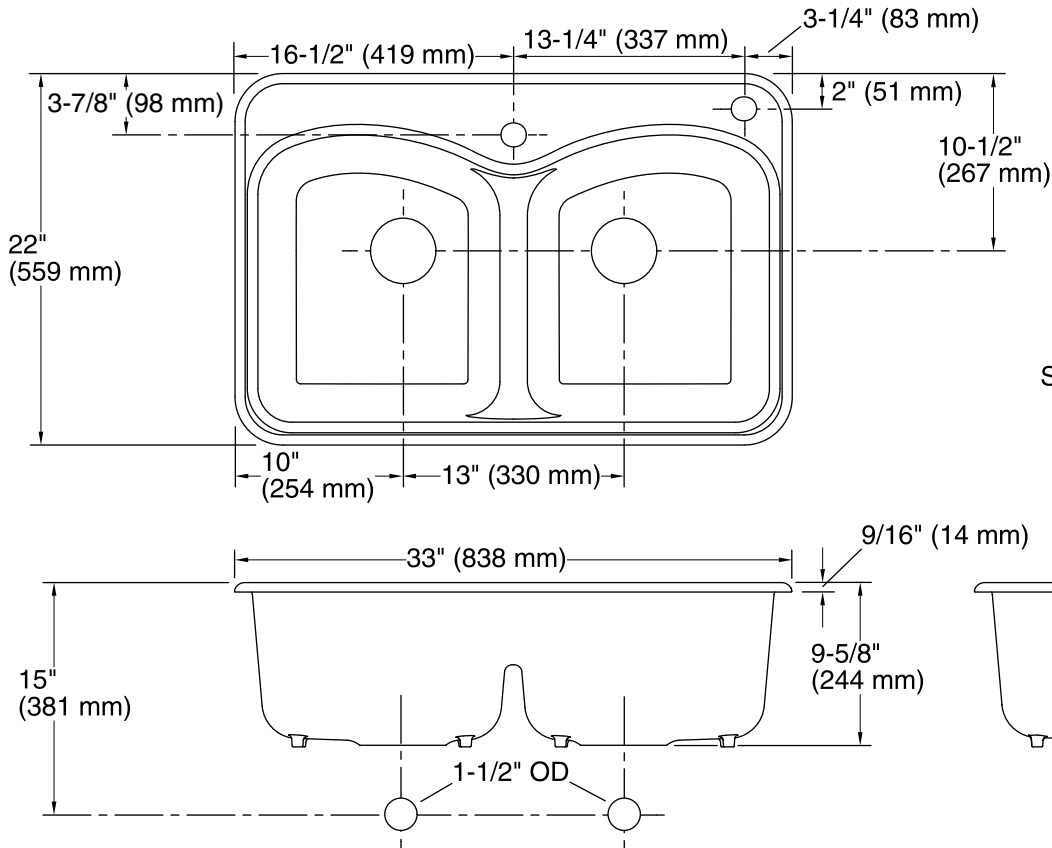

### Technical Information

All product dimensions are nominal.

Bowl configuration: Double equal

Installation: Top-mount

Min. base cabinet width: 33" (838 mm)

Bowl area (Left): Length: 15" (381 mm)  
Width: 18-3/8" (467 mm)  
Bowl depth: 9" (229 mm)

Bowl area (Right): Length: 15" (381 mm)  
Width: 18-3/8" (467 mm)  
Bowl depth: 9" (229 mm)

Number of deck holes: 2

Faucet hole(s): 1-3/8" (35 mm)

Drain hole: 3-5/8" (92 mm)

Template: 1043753-7, required, included

### Notes

Install this product according to the installation instructions.