

Features

- 27" (686 mm) minimum base cabinet width.
- Single bowl.
- 7-1/2" depth.

Material

- KOHLER® enameled cast iron.

Installation

- No faucet holes.
- Top-mount or undermount.

Recommended Products/Accessories

- K-3192 Sink rack for Iron/Tones® kitchen sinks
- K-5184 Stainless steel sink rack, 12-7/8" x 14-11/16"
- K-6539 Drainboard with Sink Rack
- K-8801 Sink Strainer
- K-8799 Sink Strainer
- K-23726 Drain treatment
- K-23725 Cast iron cleaner

Optional Products/Accessories

- K-3277 Sink basket for Undertone® and Iron/Tones® sinks
- K-3294 Hardwood cutting board for kitchen sinks
- K-11352 Disposal Flange with Stopper
- K-9000 P-Trap

Included Components

- Additional Components:
1193643 Basin clamps



Codes/Standards

















ASME A112.19.1/CSA B45.2

KOHLER® Enameled Cast Iron Kitchen Sink Lifetime Limited Warranty

See website for detailed warranty information.

Available Colors/Finishes

Color tiles intended for reference only.

Color	Code	Description
	0	White
	FF	Sea Salt™
	96	Biscuit
	NY	Dune
	55	Innocent Blush™
	95	Ice™ Grey
	G9	Sandbar
	K4	Cashmere
	FT	Basalt
	58	Thunder™ Grey
	R1	Roussillon™ Red
	20	Suede
	FP	Caviar
	7	Black Black™
	GRL	Grey Lavender
	DGB	Indigo Blue
	PLM	Black Plum

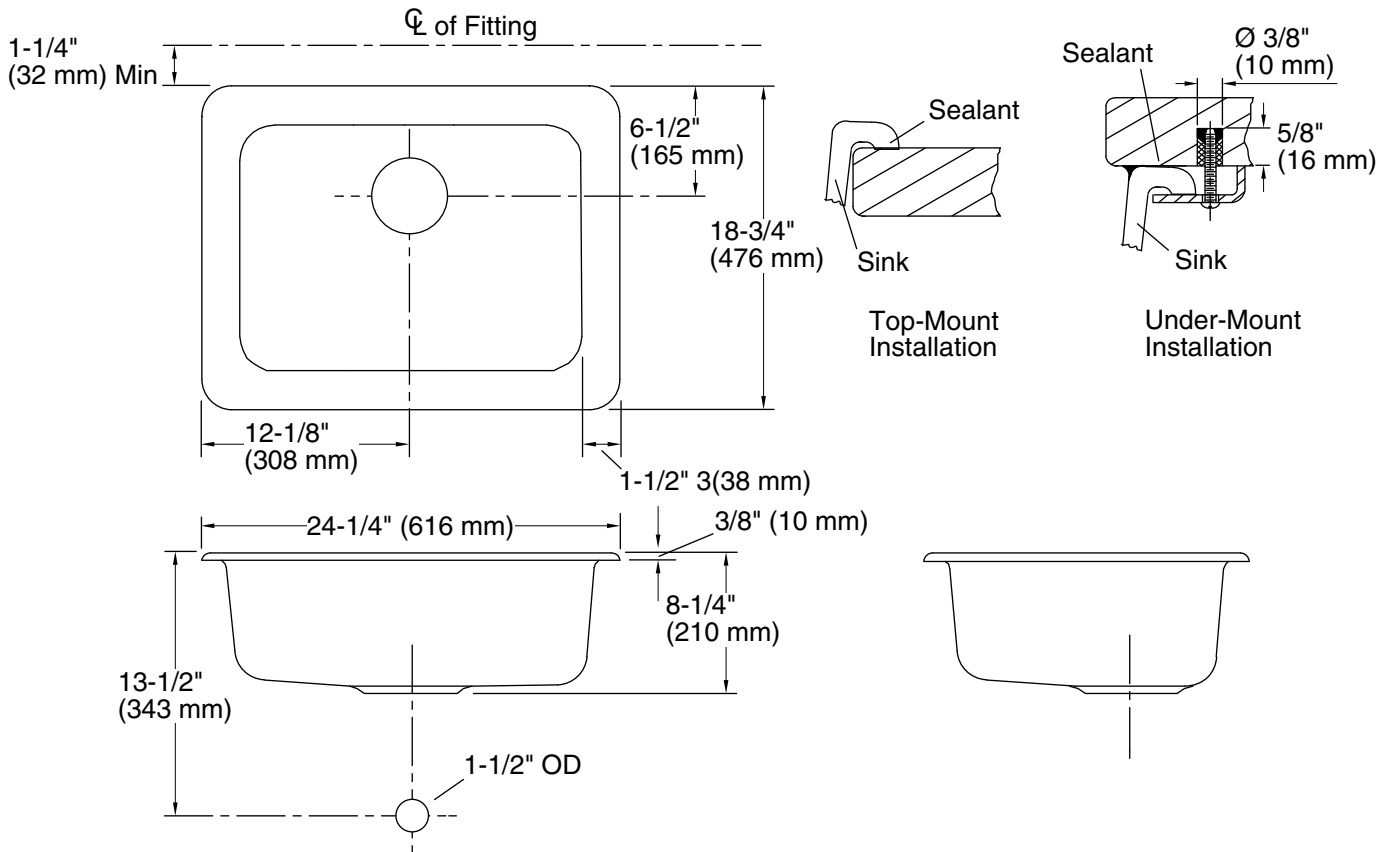

Technical Information

All product dimensions are nominal.

Bowl configuration:	Single
Installation:	Top-mount, Under-mount
Min. base cabinet width:	27" (686 mm)
Bowl area:	Length: 21" (533 mm) Width: 16" (406 mm) Bowl depth: 7-1/2" (191 mm)
Drain hole:	3-7/8" (98 mm)
Template:	114333-7, required, included

Notes

Install this product according to the installation instructions.

Supplied bowl clamp assemblies require 1" (25 mm) minimum countertop thickness. Installer must supply hardware for thinner countertops.

For multiple bowl under-mount installations, a minimum distance of 3-3/8" (86 mm) is required between bowls. Countertop supplier to determine required support.