

### Features

- 15-inch minimum base cabinet width.
- Single bowl.
- 7-inch depth.
- Two faucet holes.

### Material

- KOHLER® enameled cast iron.

### Installation

- Top-mount

### Recommended Products/Accessories

K-9000 P-Trap  
K-8801 Sink Strainer  
K-8799 Sink Strainer



ADA

### Codes/Standards











ASME A112.19.1/CSA B45.2  
ADA  
ICC/ANSI A117.1

### KOHLER® Enameled Cast Iron Kitchen Sink Lifetime Limited Warranty

See website for detailed warranty information.

### Available Colors/Finishes

*Color tiles intended for reference only.*

Color	Code	Description
	0	White
	FF	Sea Salt™
	96	Biscuit
	47	Almond
	95	Ice™ Grey
	G9	Sandbar
	33	Mexican Sand™
	K4	Cashmere
	7	Black Black™
	97	Timberline™

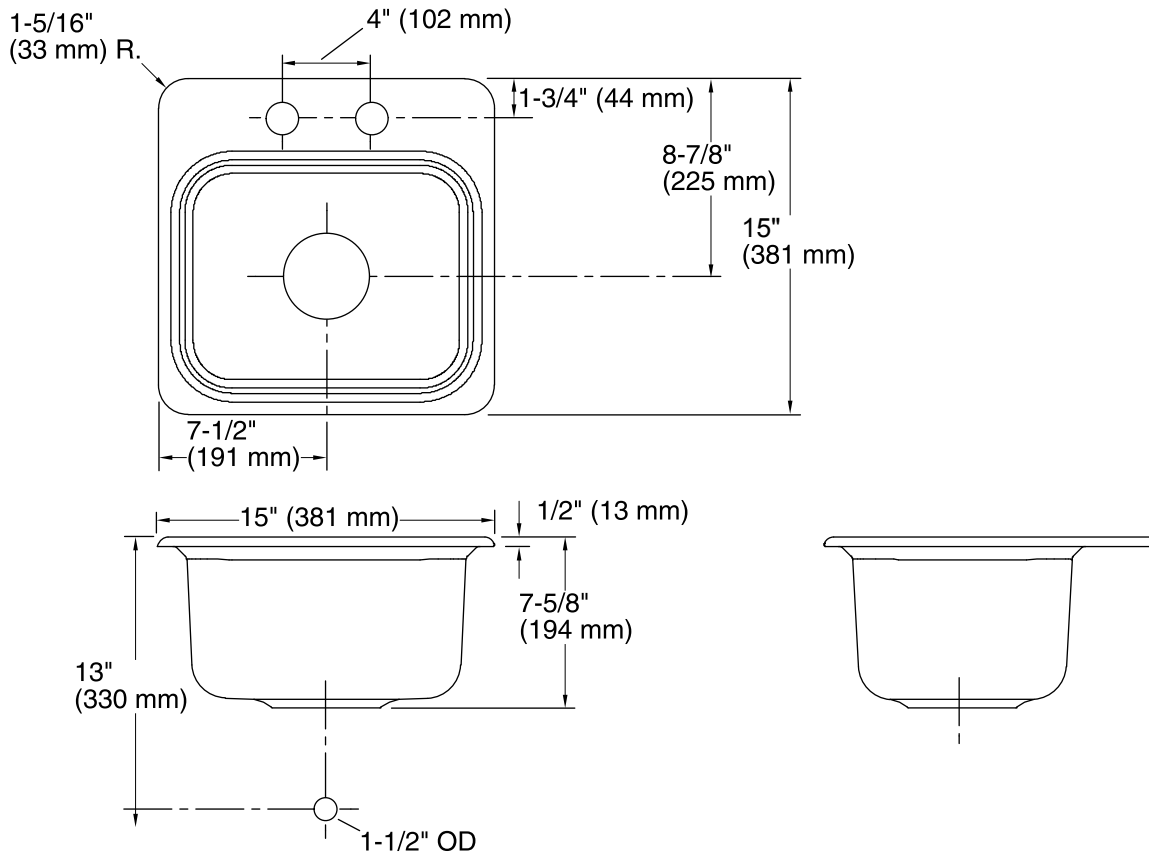

### Technical Information

All product dimensions are nominal.

Bowl configuration:	Single
Installation:	Top-mount
Cutout:	Top-mount, 14-1/4" x 14-1/4" (362 mm x 362 mm) with 1" (25 mm) radius corners
Min. base cabinet width:	15" (381 mm)
Bowl area:	Length: 9-1/4" (235 mm) Width: 12" (305 mm) Bowl depth: 7" (178 mm)
Number of deck holes:	2
Faucet hole(s):	1-3/8" (35 mm)
Drain hole:	3-7/8" (98 mm)

### Notes

Install this product according to the installation instructions.

ADA compliant when installed to the specific requirements of these regulations.

ADA permits a parallel approach to wet bars.