

### Features

- 27" (686 mm) minimum base cabinet width.
- Single bowl.
- 7-3/4" depth.
- Three faucet holes.

### Material

- KOHLER® enameled cast iron.

### Installation

- Top-mount.

### Recommended Products/Accessories

- K-6003 Sink Rack
- K-6539 Drainboard with Sink Rack
- K-8801 Sink Strainer
- K-8799 Sink Strainer
- K-23726 Drain treatment
- K-23725 Cast iron cleaner

### Optional Products/Accessories

- K-11352 Disposal Flange with Stopper
- K-9000 P-Trap



### Codes/Standards







ASME A112.19.1/CSA B45.2

### KOHLER® Enameled Cast Iron Kitchen Sink Lifetime Limited Warranty

See website for detailed warranty information.

### Available Colors/Finishes

*Color tiles intended for reference only.*

Color	Code	Description
	0	White
	96	Biscuit
	47	Almond
	55	Innocent Blush™
	Y2	Sunlight
	7	Black Black™
	97	Timberline™

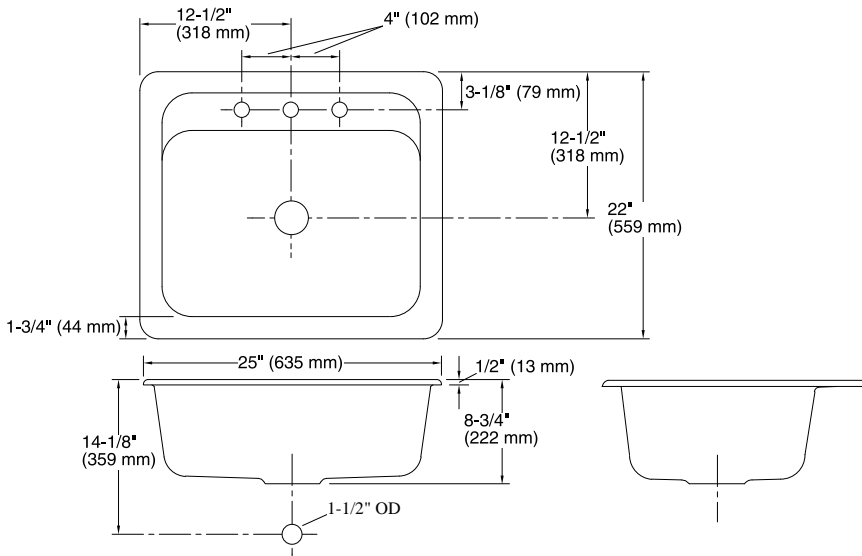

## Technical Information

All product dimensions are nominal.

Bowl configuration:	Single
Installation:	Top-mount
Cutout:	Top-mount, 23-3/4" x 20-3/4" (603 mm x 527 mm) with 1" (25 mm) radius corners
Min. base cabinet width:	27" (686 mm)
Bowl area:	Length: 22" (559 mm) Width: 15" (381 mm) Bowl depth: 7-3/4" (197 mm) Water depth: 7-3/4" (197 mm)
Number of deck holes:	3
Faucet hole(s):	1-3/8" (35 mm)
Drain hole:	3-5/8" (92 mm)

## Notes

Install this product according to the installation instructions.