

### Features

- 36-inch minimum base cabinet width.
- Large/medium bowls.
- 9-3/4" depth left bowl and 7-3/4" depth right bowl.
- Three oversized faucet holes with one oversized accessory hole to the right.
- Oversized holes allow for easy installation of faucets and accessories.
- Offset faucet ledge.

### Material

- KOHLER® enameled cast iron.

### Installation

- Undermount.

### Recommended Products/Accessories

- K-6001 Left-Bowl Sink Rack
- K-6539 Drainboard with Sink Rack
- K-8801 Sink Strainer
- K-8799 Sink Strainer
- K-23726 Drain treatment
- K-23725 Cast iron cleaner
- 1411886 Undermount sink kit 23"

### Optional Products/Accessories

- K-6521 Sink Basket
- K-6515 Cutting Board
- K-11352 Disposal Flange with Stopper
- K-9000 P-Trap



### Codes/Standards









ASME A112.19.1/CSA B45.2

### KOHLER® Enameled Cast Iron Kitchen Sink Lifetime Limited Warranty

See website for detailed warranty information.

### Available Colors/Finishes

*Color tiles intended for reference only.*

Color	Code	Description
	0	White
	FF	Sea Salt™
	96	Biscuit
	47	Almond
	NY	Dune
	95	Ice™ Grey
	K4	Cashmere
	FT	Basalt
	58	Thunder™ Grey
	FP	Caviar
	7	Black Black™

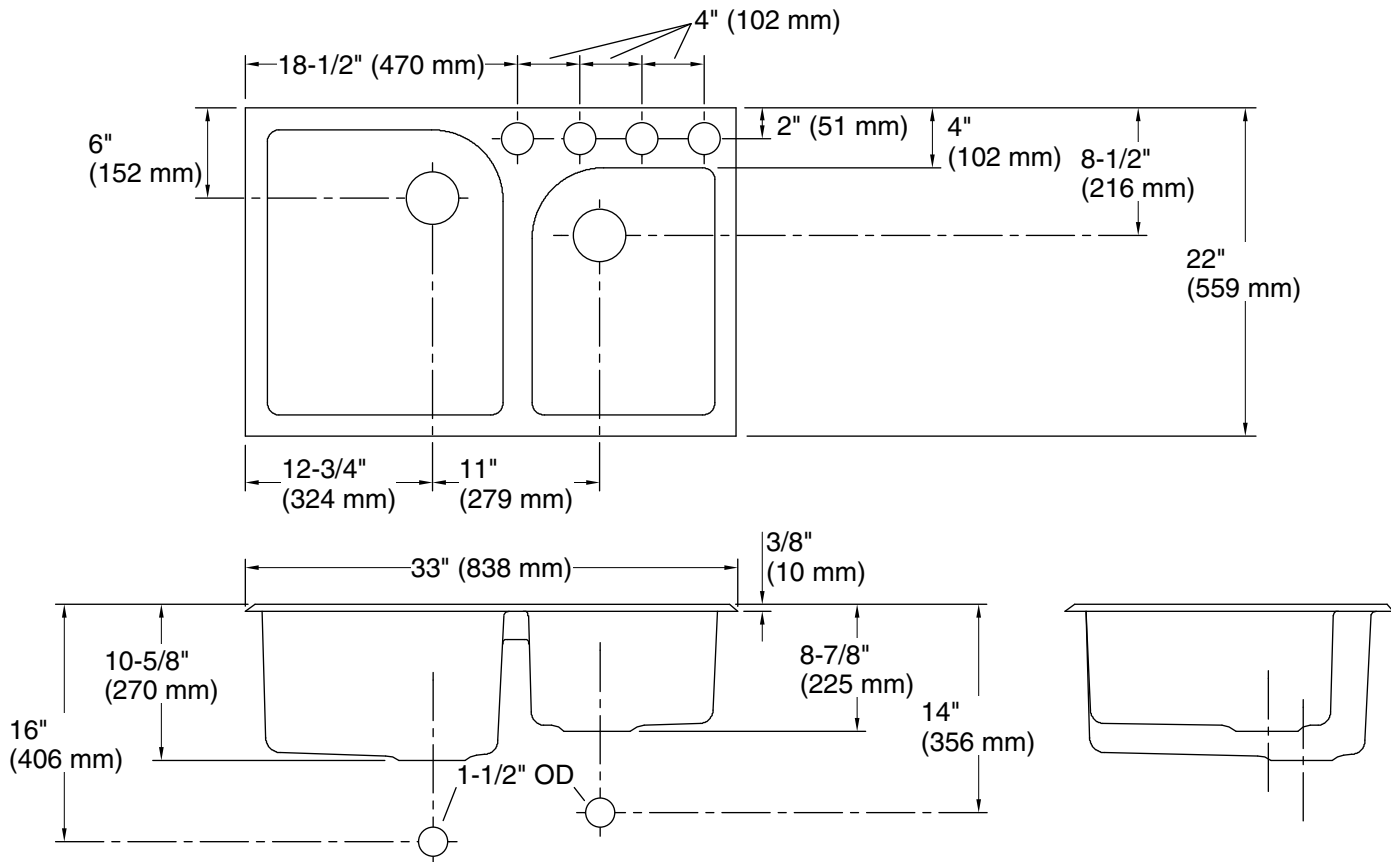

### Technical Information

All product dimensions are nominal.

Bowl configuration: Off-set Large/small

Installation: Undermount

Min. base cabinet width: 36" (914 mm)

Bowl area (Left): Length: 16" (406 mm)  
Width: 19" (483 mm)  
Bowl depth: 9-3/4" (248 mm)

Bowl area (Right): Length: 12" (305 mm)  
Width: 17" (432 mm)  
Bowl depth: 7-3/4" (197 mm)

Number of deck holes: 4

Faucet hole spacing: 4" (102 mm)

Faucet hole(s): 2-3/8" (60 mm)

Drain hole: 3-5/8" (92 mm)

Template: 116808-7, required, included

### Notes

Install this product according to the installation instructions.