

Features

- 33-inch minimum base cabinet width.
- Double equal bowls.
- 9-inch depth.
- Four oversized faucet holes.
- Oversized holes allow for easy installation of faucets and accessories.
- Rear drain increases workspace in the sink and storage space underneath.
- Includes cutout template.

Material

- KOHLER® enameled cast iron.

Installation

- Top-mount

Recommended Products/Accessories

K-9000 P-Trap
K-6197 Sink Rack
K-6377 Sponge Caddy
K-6378 Kitchen Brush Caddy
K-6379 Kitchen Squeegee
K-6382 Disinfecting Wipes Dispenser
K-6383 Soap Dispenser
K-8618 Paper Towel Holder
K-8619 Flexible Kitchen Mat
K-8624 Dish Scraper
K-8801 Sink Strainer
K-8799 Sink Strainer

Optional Products/Accessories

K-6545 Sponge Caddy



Codes/Standards









ASME A112.19.1/CSA B45.2

KOHLER® Enameled Cast Iron Kitchen Sink Lifetime Limited Warranty

See website for detailed warranty information.

Available Colors/Finishes

Color tiles intended for reference only.

Color	Code	Description
	0	White
	FF	Sea Salt™
	96	Biscuit
	47	Almond
	FD	Cane Sugar™
	95	Ice™ Grey
	K4	Cashmere
	7	Black Black™

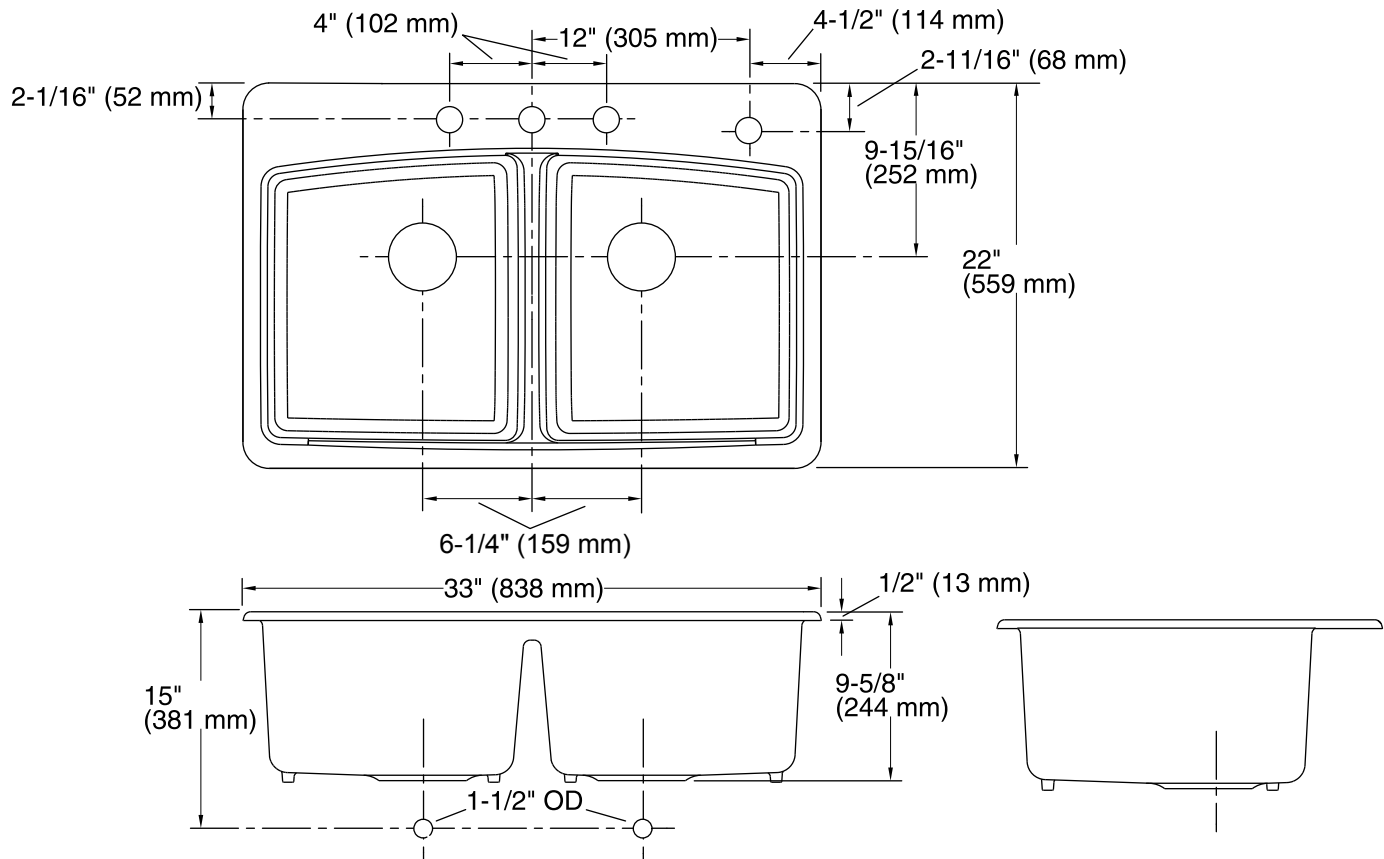

Technical Information

All product dimensions are nominal.

Bowl configuration:	Double equal
Installation:	Top-mount
Min. base cabinet width:	33" (838 mm)
Bowl area (Left):	Length: 14-3/16" (360 mm) Width: 16-1/16" (408 mm) Bowl depth: 9" (229 mm)
Bowl area (Right):	Length: 14-3/16" (360 mm) Width: 16-1/16" (408 mm) Bowl depth: 9" (229 mm)
Number of deck holes:	4
Faucet hole spacing:	4" (102 mm)
Faucet hole(s):	1-3/8" (35 mm)
Drain hole:	3-7/8" (98 mm)
Template:	1174556-7, required, included

Notes

Install this product according to the installation instructions.

NOTICE: Countertop manufacturer or cutter must use the cut-out template provided with the product, or a current one provided by Kohler Co. (call 1-800-4-KOHLER). Kohler Co. is not responsible for cutout errors when the incorrect cut-out template is used.