

### Features

- 36-inch minimum base cabinet width.
- Double equal bowls.
- 9-inch depth.
- Three faucet holes with one accessory hole to the right.
- Rear drain maximizes flat basin surface and storage space under the counter.

### Material

- KOHLER® enameled cast iron.

### Installation

- Top-mount

### Recommended Products/Accessories

- K-9000 P-Trap
- K-6539 Drainboard with Sink Rack
- K-6377 Sponge Caddy
- K-6378 Kitchen Brush Caddy
- K-6379 Kitchen Squeegee
- K-6382 Disinfecting Wipes Dispenser
- K-6383 Soap Dispenser
- K-8618 Paper Towel Holder
- K-8619 Flexible Kitchen Mat
- K-8624 Dish Scraper
- K-5133 Left-Bowl Sink Rack
- K-5135 Right-Bowl Sink Rack
- K-8801 Sink Strainer
- K-8799 Sink Strainer

### Optional Products/Accessories

- K-6016L Left-Bowl Sink Rack
- K-6016R Right-Bowl Sink Rack
- K-6545 Sponge Caddy
- K-6603L Sink Basket
- K-6603R Sink Basket

### Included Components

- Product consists of:  
1054375 Under-mount Sink Kit, 23"



### Codes/Standards









ASME A112.19.1/CSA B45.2

### KOHLER® Enameled Cast Iron Kitchen Sink Lifetime Limited Warranty

See website for detailed warranty information.

### Available Colors/Finishes

*Color tiles intended for reference only.*

Color	Code	Description
	0	White
	FF	Sea Salt™
	96	Biscuit
	47	Almond
	FD	Cane Sugar™
	95	Ice™ Grey
	33	Mexican Sand™
	K4	Cashmere
	7	Black Black™

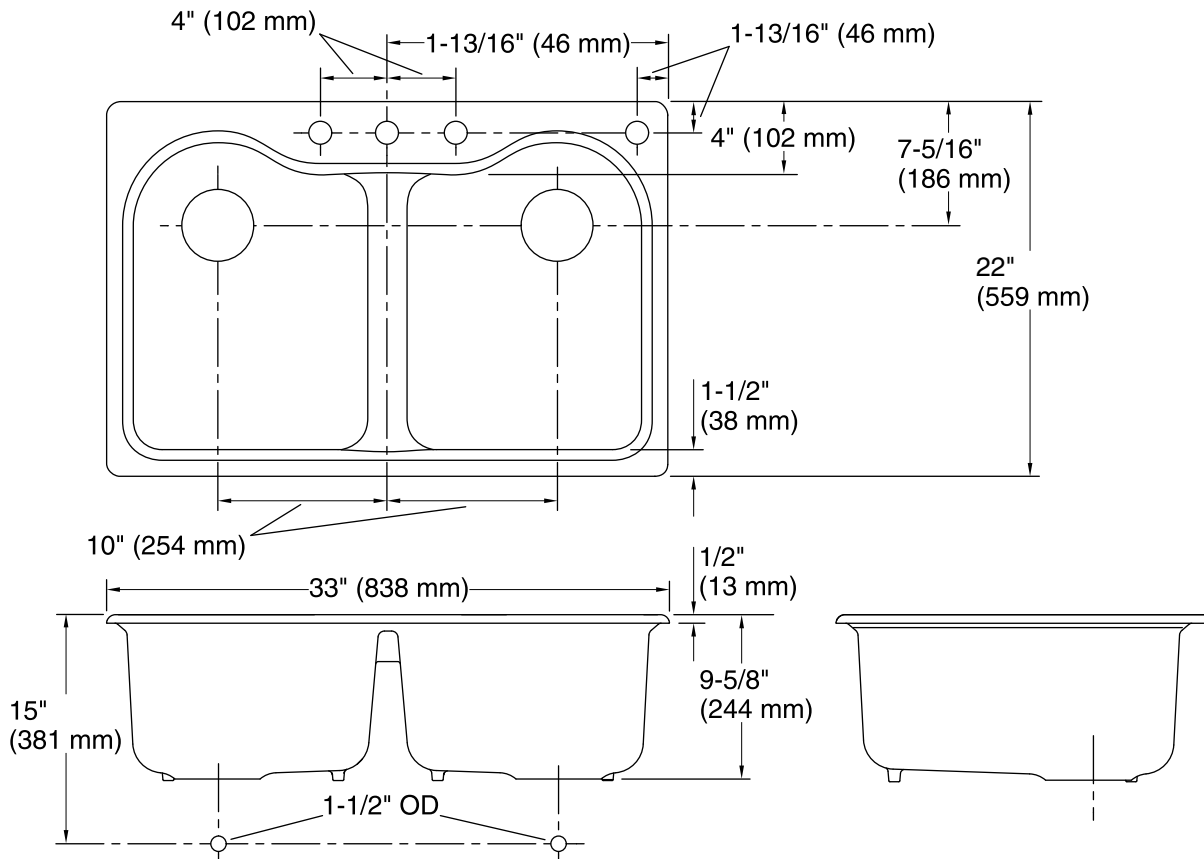

## Technical Information

All product dimensions are nominal.

Bowl configuration:	Double equal
Installation:	Top-mount
Min. base cabinet width:	33" (838 mm)
Bowl area (Left):	Length: 14-1/8" (359 mm) Width: 16-1/4" (413 mm) Bowl depth: 9" (229 mm)
Bowl area (Right):	Length: 14-1/8" (359 mm) Width: 16-1/4" (413 mm) Bowl depth: 9" (229 mm)
Number of deck holes:	4
Faucet hole spacing:	4" (102 mm)
Faucet hole(s):	1-3/8" (35 mm)
Drain hole:	3-7/8" (98 mm)
Template:	1125670-7, required, included

## Notes

Install this product according to the installation instructions.

**NOTICE:** The countertop manufacturer or cutter must use the cut-out template provided with the product, or a current one provided by the Kohler Co. (Call 1-800-4-KOHLER.) Kohler Co. is not responsible for cut-out errors when the incorrect cut-out template is used.