

Features

- Two lever handles allow for both volume and temperature control.
- 6-3/8" (162 mm) spout reach.
- 1.2 gpm (4.5 lpm) maximum flow rate at 60 psi (4.14 bar).
- Includes metal pop-up drain with 1-1/4" tailpiece.
- KOHLER ceramic disc valves exceed industry longevity standards for a lifetime of durable performance.
- Quick-Connect hose connections make widespread faucet installation a snap.
- Coordinates with Devonshire faucets, accessories, and showering components to complete your bathroom.

Material

- Premium metal construction for durability and reliability.
- KOHLER finishes resist corrosion and tarnishing.

Installation

- Handles are preassembled on valves to simplify installation.
- For 8" - 16" (203 - 406 mm) centers.
- Widespread.

Recommended Products/Accessories

- K-23726 Drain treatment
- K-23723 Faucet cleaner



ADA **CSA B651** **OBC**

Codes/Standards







ASME A112.18.1/CSA B125.1
 NSF/ANSI 61
 NSF/ANSI 372
 DOE - Energy Policy Act 1992
 EPA WaterSense®
 California Energy Commission (CEC)
 ADA
 ICC/ANSI A117.1
 CSA B651
 OBC

KOHLER® Faucet Lifetime Limited Warranty

See website for detailed warranty information.

Available Colors/Finishes

Color tiles intended for reference only.

Color	Code	Description
	CP	Polished Chrome
	SN	Vibrant® Polished Nickel
	PB	Vibrant® Polished Brass
	BN	Vibrant® Brushed Nickel
	BV	Vibrant® Brushed Bronze
	2BZ	Oil-Rubbed Bronze
	BX	Vibrant® Brazen Bronze

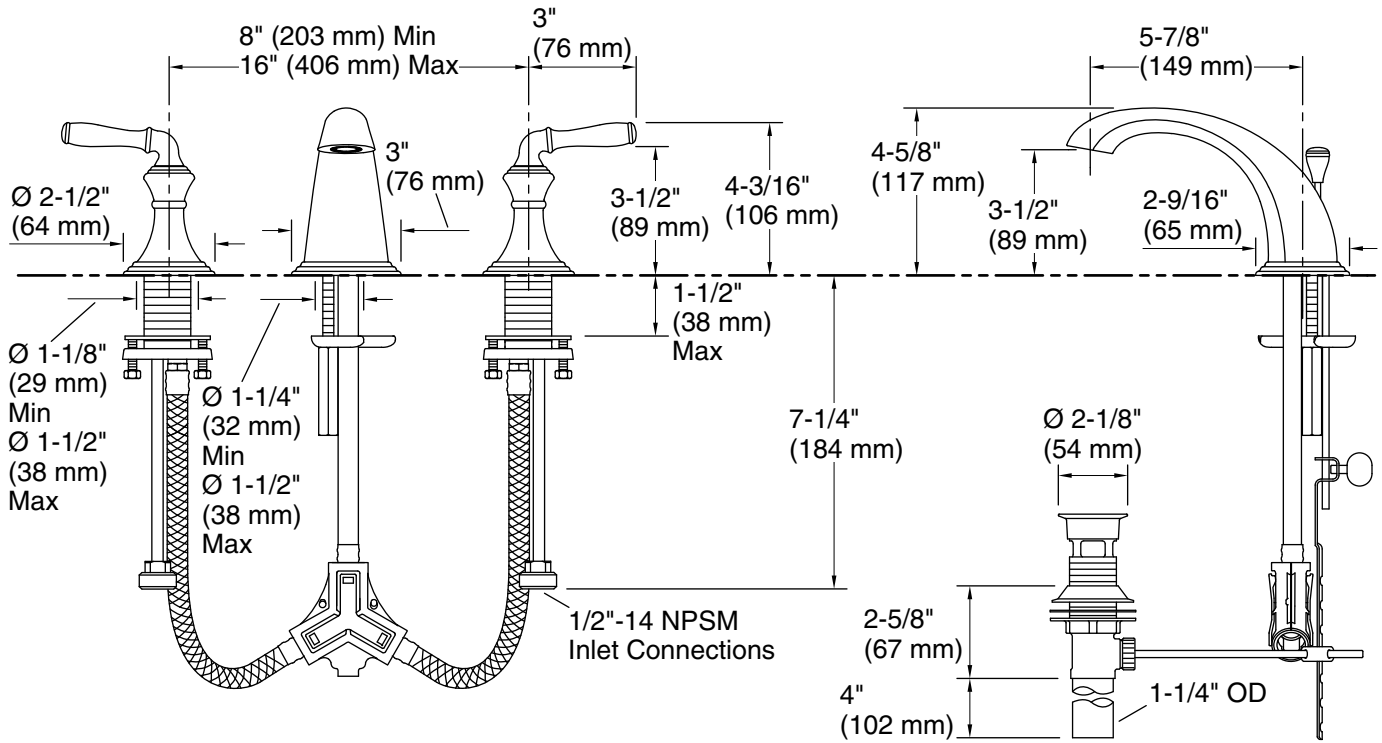

Technical Information

All product dimensions are nominal.

Faucet:

Flow rate: 1.2 gal/min (4.5 l/min)

Pressure: 60 psi (4.1 bar)

Spout:

Spout reach: 5-7/8" (149 mm)

Notes

Install this product according to the installation guide.

ADA compliant for handles only.

ADA, OBC, CSA B651 compliant when installed to the specific requirements of these regulations.