

## Features

- 8-inch center faucet holes.
- Oval basin with concentric ring styling.

## Material

- KOHLER® enameled cast iron.

## Installation

- Drop-in

## Recommended Products/Accessories

K-8998 P-Trap



ADA

CSA B651

OBC

## Codes/Standards

ASME A112.19.1/CSA B45.2

ADA

ICC/ANSI A117.1

CSA B651









OBC

## Lifetime Limited Warranty for KOHLER® Cast Iron Components

See website for detailed warranty information.

## Available Colors/Finishes

*Color tiles intended for reference only.*

Color	Code	Description
	0	White
	96	Biscuit
	NY	Dune
	95	Ice™ Grey
	G9	Sandbar
	33	Mexican Sand™
	K4	Cashmere
	58	Thunder™ Grey
	97	Timberline™

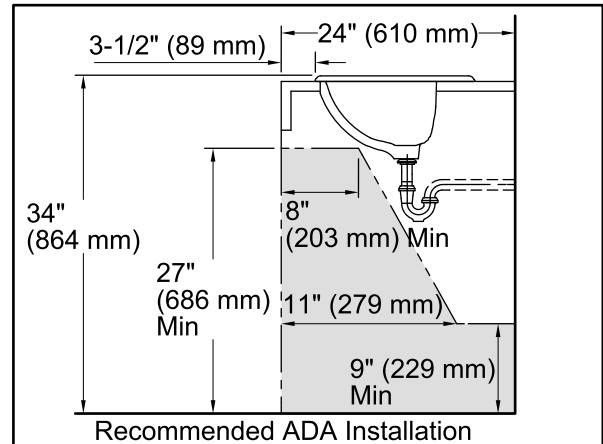
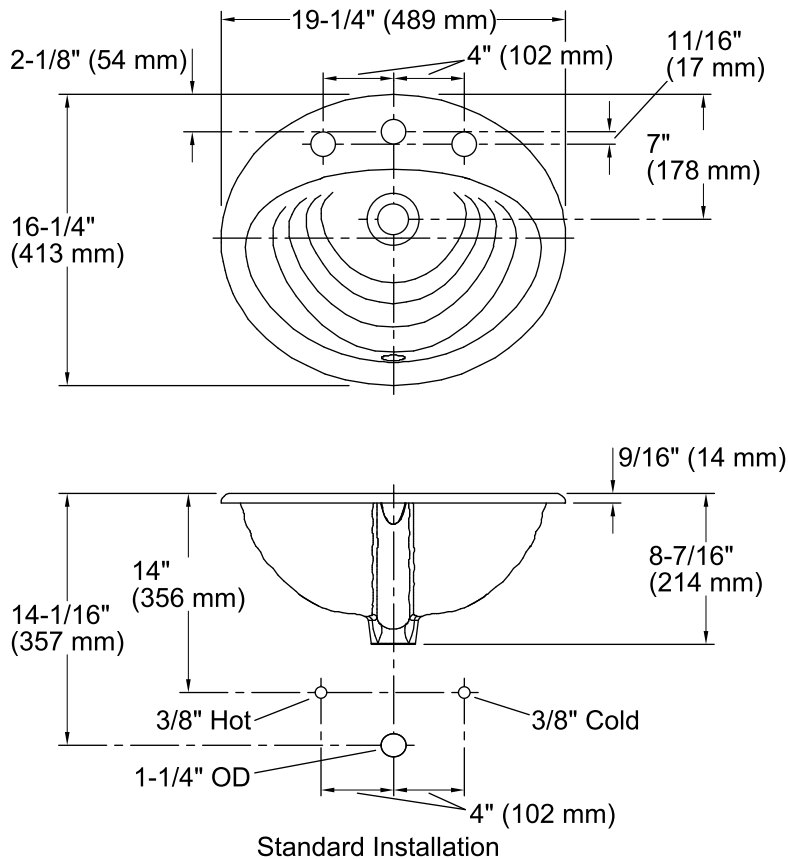

## Technical Information

All product dimensions are nominal.

Bowl configuration:	Single
Installation:	Drop-in
Bowl area:	Length: 16" (406 mm) Width: 11" (279 mm) Water depth: 4-7/8" (124 mm)
Number of deck holes:	3
Faucet hole spacing:	8" (203 mm)
Faucet hole(s):	1-3/8" (35 mm)
Drain hole:	1-3/4" (44 mm)
Template:	1002972-7, required, included

## Notes

Install this product according to the installation instructions.

ADA, OBC, CSA B651 compliant when installed to the specific requirements of these regulations.