

Features

- Two oval handles allow for both volume and temperature control
- Includes metal pop-up drain with lift rod and tailpiece.
- 1.2 gal/min (4.5 l/min) maximum flow rate [max at 60 psi (4.14 bar)].
- 4-5/8" (117 mm) spout reach.
- KOHLER ceramic disc valves exceed industry longevity standards for a lifetime of durable performance
- Handles pre-assembled on KOHLER Ultraglide™ Ceramic Disc Valves to simplify installation
- Coordinates with Antique faucets, accessories, and showering components to complete your bathroom.
- Premium Metal Construction
- For 8" to 16" centers
- Widespread
- Two-handle widespread sink faucet for 8" - 16" centers
- KOHLER ceramic disc valves exceed industry longevity standards two times for a lifetime of durable performance
- Solid brass construction for durability and reliability
- KOHLER finishes resist corrosion and tarnishing, exceeding industry durability standards two times
- Handles pre-assembled on valves to simplify installation
- Coordinates with Antique faucets and accessories.
- 1.2 gpm (gallons per minute) flow rate.
- Requires K-258 Antique ceramic handle insets and skirts (sold separately).

Installation

- Bath- or deck-mount.

Required Products/Accessories

K-258 Ceramic Handle Insets and Skirts



ADA

Codes/Standards

ASME A112.18.1/CSA B125.1

NSF/ANSI 61

NSF/ANSI 372

All applicable US Federal and State material regulations

DOE - Energy Policy Act 1992

EPA WaterSense®

California Energy Commission (CEC)

ADA







ICC/ANSI A117.1

KOHLER® Faucet Lifetime Limited Warranty

See website for detailed warranty information.

Available Colors/Finishes

Color tiles intended for reference only.

Color	Code	Description
	CP	Polished Chrome
	PB	Vibrant® Polished Brass
	G	Brushed Chrome
	BN	Vibrant® Brushed Nickel
	BV	Vibrant® Brushed Bronze
	AU	Polished Gold

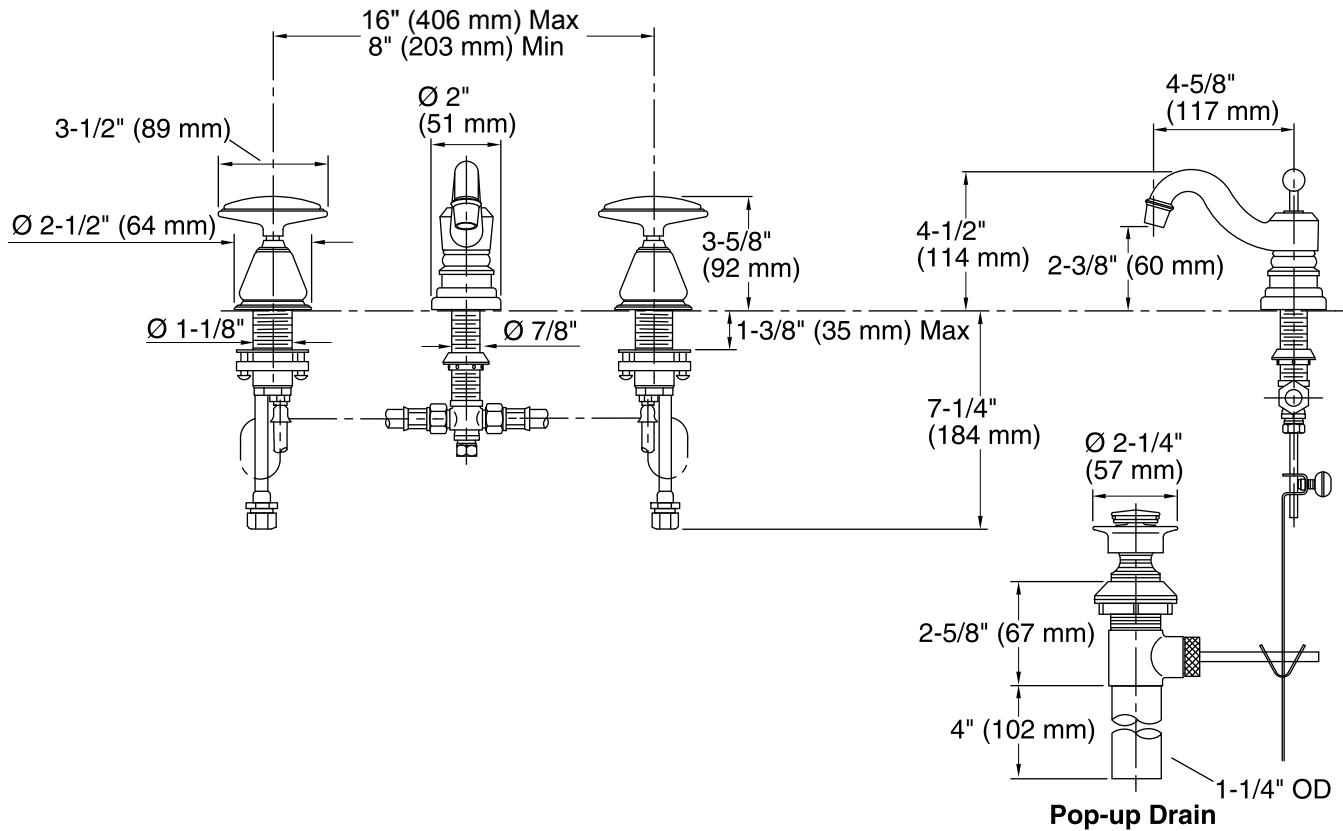

Technical Information

All product dimensions are nominal.

Faucet:

Flow rate: 1.2 gal/min (4.5 l/min)

Pressure: 60 psi (4.1 bar)

Drain included: Yes

Drain tailpiece included: Yes

Spout:

Spout reach: 4-5/8" (117 mm)

Handle clearance: 1-3/4" (44 mm)

Notes

Install this product according to the installation guide.

ADA compliant when installed to the specific requirements of these regulations.