



Yin Yang® Wading Pool®

Above-counter Bathroom Sink

K-2354-4

Features

- 4-inch center faucet holes.
- Unique, shallow basin.
- Overflow drain.

Material

- Vitreous china.

Installation

- Vessel

Recommended Products/Accessories

K-7107 Decorative Drain

K-7108 Decorative Drain

K-7127 Drain

K-9018 P-Trap



ADA

Codes/Standards

ASME A112.19.2/CSA B45.1

ADA

ICC/ANSI A117.1

KOHLER® One-Year Limited Warranty

See website for detailed warranty information.

Available Colors/Finishes

Color tiles intended for reference only.

Color	Code	Description
-------	------	-------------

	0	White
--	---	-------

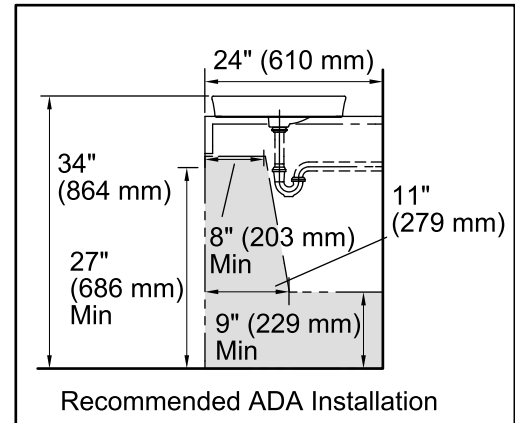
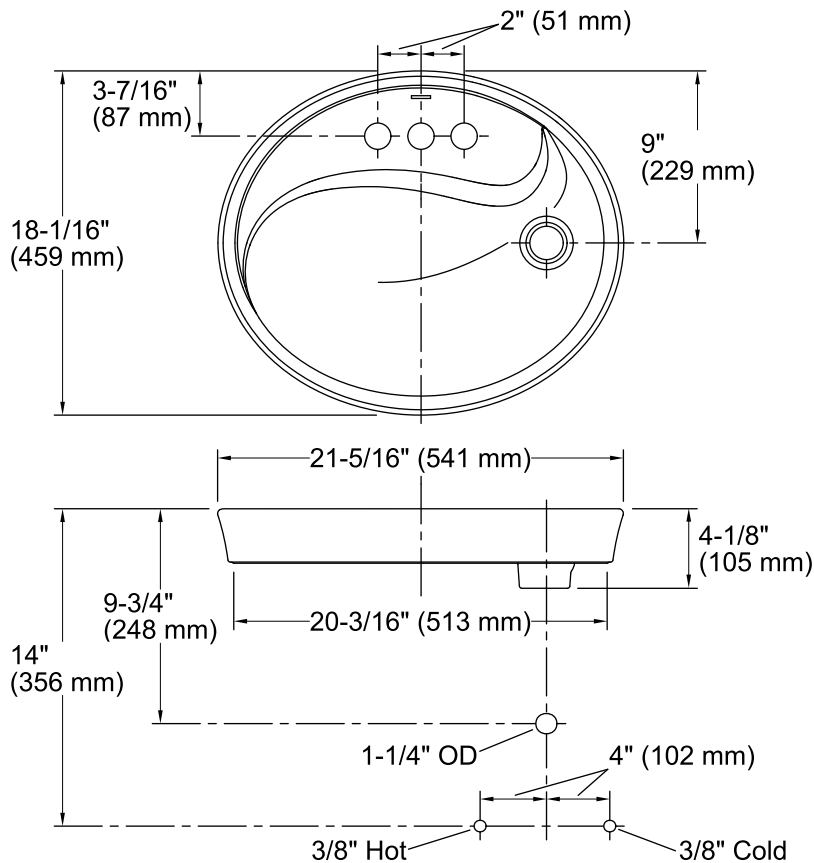

Recommended ADA Installation

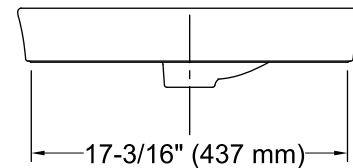

Technical Information

All product dimensions are nominal.

Bowl configuration:	Single
Installation:	Vessel
Bowl area (Only):	Length: 19-11/16" (500 mm) Width: 12-7/16" (316 mm) Water depth: 9/16" (14 mm)
Number of deck holes:	3
Faucet hole spacing:	4" (102 mm)
Faucet hole(s):	1-1/4" (32 mm)
Drain hole:	1-3/4" (44 mm)
Template:	1066138-7, required, included

Notes

Install this product according to the installation instructions.

IMPORTANT! Product rests on a countertop. Consider height of product when designing installation.

Choose a faucet that will provide adequate clearance and will direct the water stream to the center of the bathroom sink.

When installing a pop-up drain to this bathroom sink, it may be necessary to bend the drain linkage to allow proper reach to the faucet lift rod.

NOTICE: The countertop manufacturer or cutter must use the cut-out template provided with the product, or a current cut-out template provided by Kohler Co. (1-800-4KOHLER). Kohler Co. is not responsible for cutout errors when an incorrect cut-out template is used.

ADA compliant when installed to the specific requirements of these regulations.