

Features

- Oval basin.
- Overflow drain.
- Coordinates with other products in the Devonshire collection.

Material

- Vitreous china.

Installation

- No faucet holes; requires wall- or counter-mount faucet.
- Undermount.

Recommended Products/Accessories

K-9018 P-Trap
K-23726 Drain treatment
K-23725 Cast iron cleaner

Included Components

Additional Components:
1193643 Basin clamps



ADA **CSA B651**

Codes/Standards









ASME A112.19.2/CSA B45.1
ADA
ICC/ANSI A117.1
CSA B651

KOHLER® One-Year Limited Warranty

See website for detailed warranty information.

Available Colors/Finishes

Color tiles intended for reference only.

Color	Code	Description
	0	White
	96	Biscuit
	NY	Dune
	95	Ice™ Grey
	G9	Sandbar
	K4	Cashmere
	58	Thunder™ Grey
	7	Black Black™

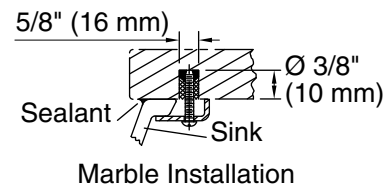
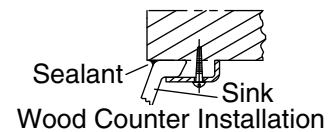
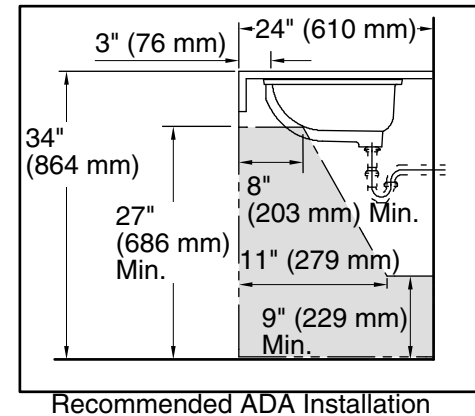
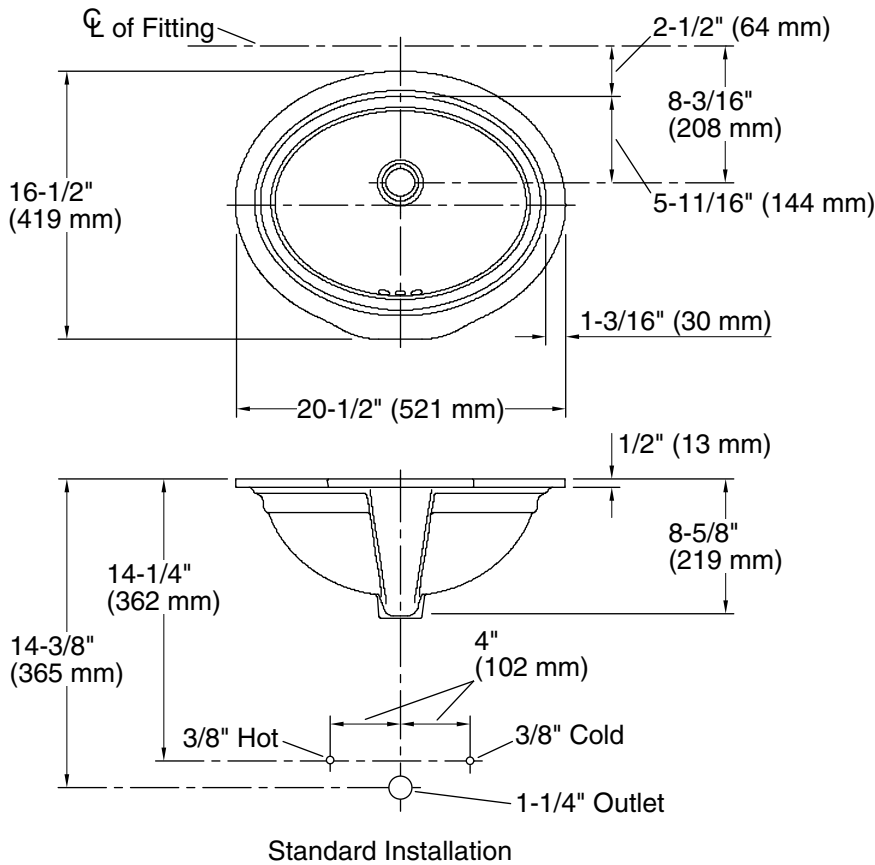

Technical Information

All product dimensions are nominal.

- Bowl configuration: Single
- Installation: Under-mount
- Bowl area (Only): Length: 18-1/8" (460 mm)
Width: 14" (356 mm)
Water depth: 4-3/16" (106 mm)
- Drain hole: 1-3/4" (44 mm)
- Template: 1050263-7, required, not included

Notes

Install this product according to the installation instructions.

NOTICE: Countertop manufacturer or cutter must use the current product template available at www.kohler.com, or by calling 1-800-4KOHLER. Kohler Co. is not responsible for cutout errors when the incorrect cutout template is used.

ADA, CSA B651 compliant when installed to the specific requirements of these regulations.