

Features

- Metal construction.
- Brass valve bodies.
- Pop-up drain with lift rod and tailpiece.
- 5-1/2" (140 mm) spout reach.
- Stationary spout.
- For 8" (203 mm) or 16" (406 mm) centers.
- Quarter-turn washerless ceramic disc valves.
- Cross handles.
- Low gooseneck spout.
- 1.2 gal/min (4.5 l/min) maximum flow rate [max at 60 psi (4.14 bar)].

Material

- KOHLER finishes resist corrosion and tarnishing.



ADA

Codes/Standards







ASME A112.18.1/CSA B125.1
 NSF/ANSI 61
 NSF/ANSI 372
 All applicable US Federal and State material regulations
 DOE - Energy Policy Act 1992
 EPA WaterSense®
 California Energy Commission (CEC)
 ADA
 ICC/ANSI A117.1

KOHLER® Faucet Lifetime Limited Warranty

See website for detailed warranty information.

Available Colors/Finishes

Color tiles intended for reference only.

Color	Code	Description
	CP	Polished Chrome
	SN	Vibrant® Polished Nickel
	PGD	Vibrant® Moderne Polished Gold
	BGD	Vibrant® Moderne Brushed Gold
	G	Brushed Chrome
	BN	Vibrant® Brushed Nickel
	BV	Vibrant® Brushed Bronze

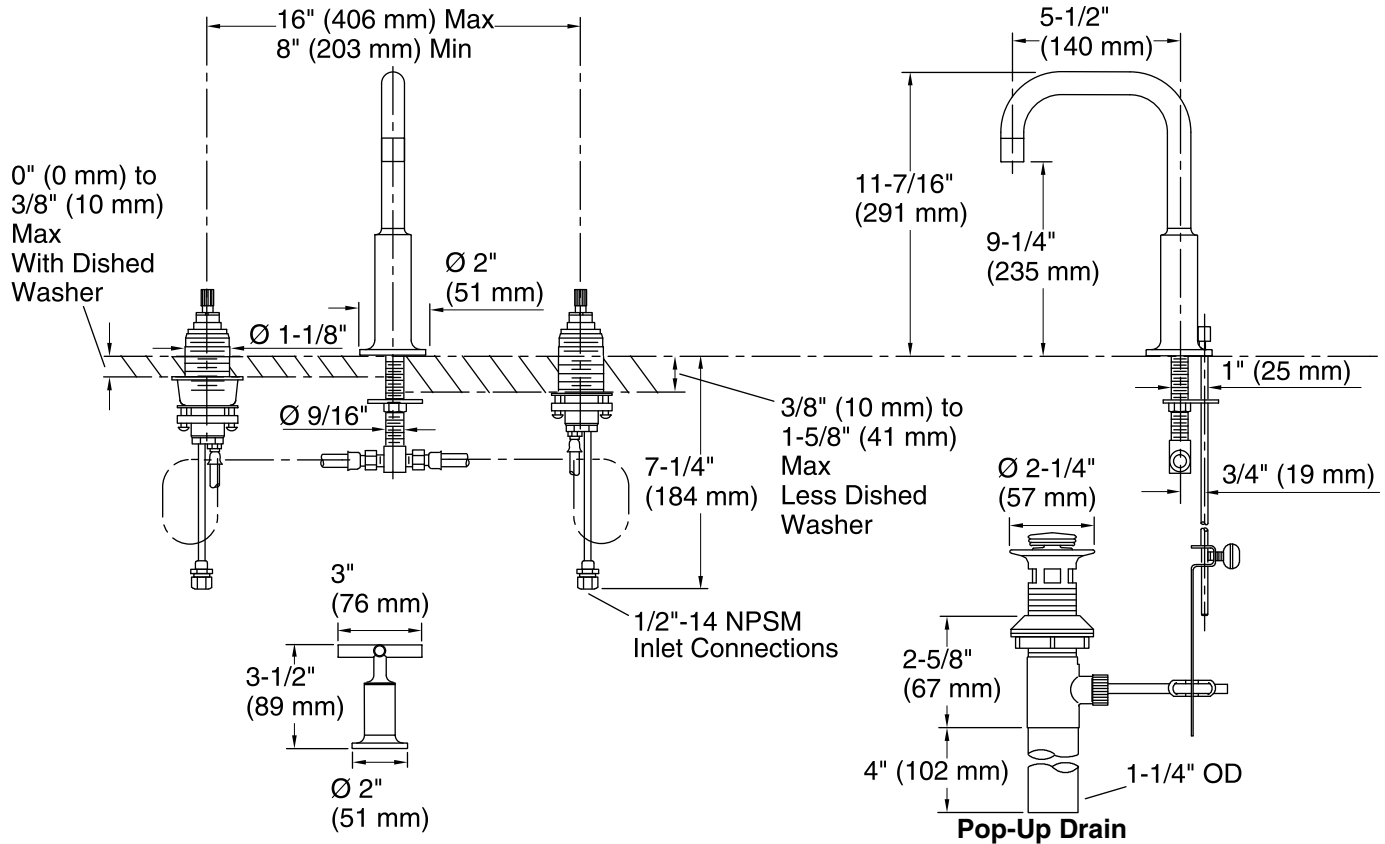

Technical Information

All product dimensions are nominal.

Faucet:

Flow rate: 1.2 gal/min (4.5 l/min)

Pressure: 60 psi (4.1 bar)

Drain included: Yes

Drain tailpiece included: Yes

Spout:

Spout reach: 5-1/2" (140 mm)

Handle clearance: 1-1/2" (38 mm)

Notes

Install this product according to the installation guide.

ADA compliant when installed to the specific requirements of these regulations.