



Features

- 120 airjets release thousands of bubbles that surround, support, and massage the body.
- Variable-speed blower lets you adjust massage intensity to 18 levels.
- Molded lumbar support and armrests offer extra comfort while bathing.
- Textured bottom surface
- Immediate and manual purge cycles remove residual water from air channels after use.
- Reversible drain.
- Coordinates with other products in the Devonshire collection.

Material

- Acrylic

Hydrotherapy

- BubbleMassage

Installation

- Drop-in

Additional Hydrotherapy Options

- Soaking Bath - K-1184-0
- Soaking Bath + Bask heated surface - K-1184-W1
- BubbleMassage air bath - K-1357-G
- BubbleMassage air bath + Bask heated surface - K-1357-GW
- VibrAcoustic - K-1357-VB
- VibrAcoustic + Bask heated surface - K-1357-VBW
- Whirlpool - K-1357-0
- Whirlpool + Bask heated surface - K-1357-W1
- Whirlpool + heater - K-1357-H

Recommended Products/Accessories

K-1446 Remote Installation Kit
K-7161-AF Bath Drain
K-24916 Wireless Music Kit
K-1491 Bath/Whirlpool Pillow
K-1601 Bath/Whirlpool Footstop
K-7213 27" Cable Bath Drain
K-7214 27" Cable Bath Drain
K-7259 Clearflo Bath Drain
K-9497 2-1/2" Keypad Trim
K-37380 30" Rough-in Cable Bath Drain
K-37383 30" Rough-in Cable Bath Drain
K-702200-G54 Frameless Sliding Bath Door
K-702200-L Frameless Sliding Bath Door
K-702204-G54 Frameless Sliding Bath Door
K-702204-L Frameless Sliding Bath Door
K-702205-L Frameless Sliding Bath Door
K-1177 Vinyl Tiling-in Bead



Codes/Standards

ASME A112.19.7/CSA B45.10
CSA B45.5/IAPMO Z124
ASTM E162
ASTM E662
UL 1795
CSA C22.2 No. 218.2
Greenguard UL 2818 - Gold





KOHLER® Plastic Baths and Receptors Lifetime Limited Warranty KOHLER® Hydrotherapy Components Five-Year Limited Warranty

See website for detailed warranty information.

Available Colors/Finishes

Color tiles intended for reference only.

Color Code Description

	0	White
	96	Biscuit
	47	Almond
	NY	Dune
	G9	Sandbar

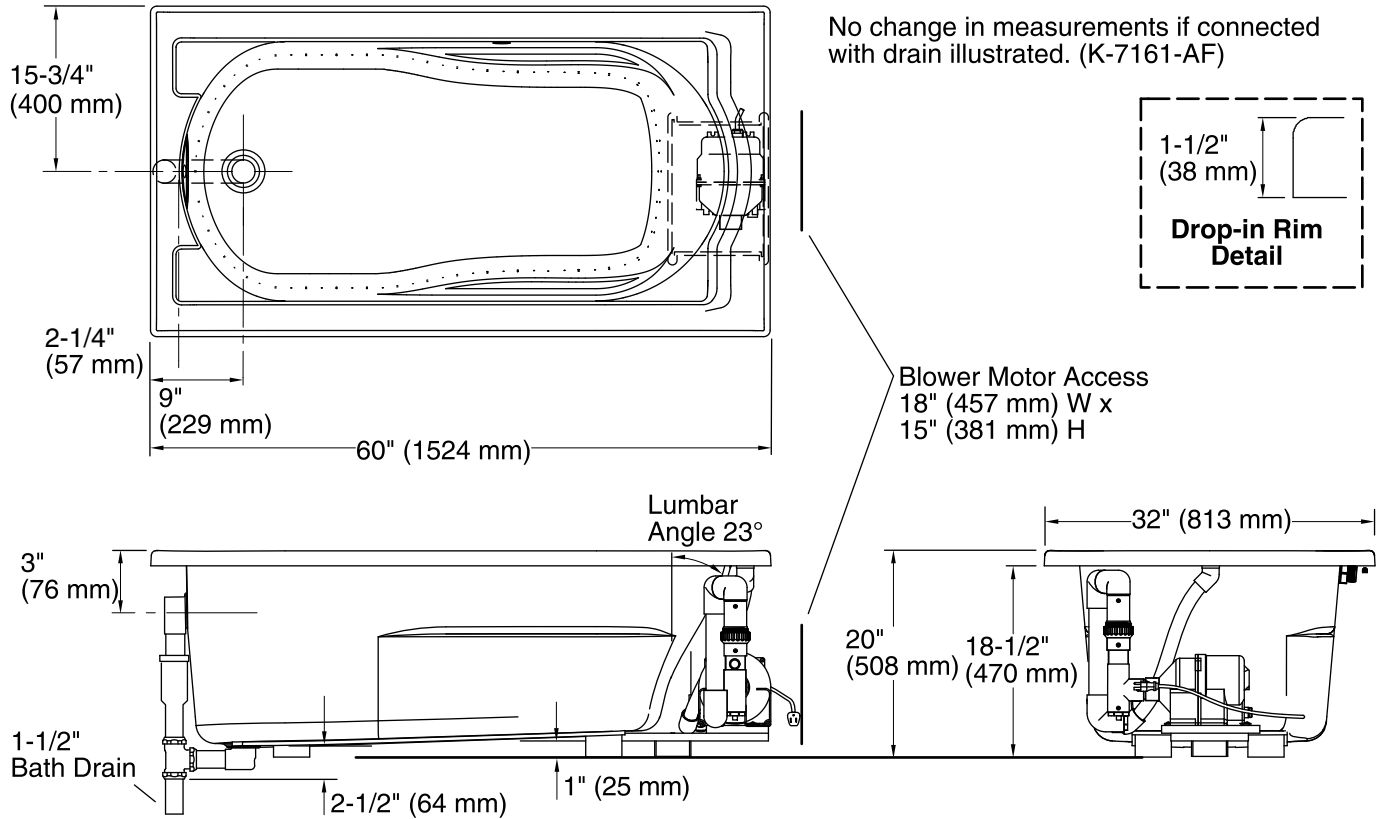

No change in measurements if connected with drain illustrated. (K-7161-AF)

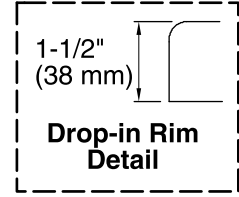

Blower Motor Access
18" (457 mm) W x
15" (381 mm) H

Notes

Measure your actual product for rough-in details. Install this product according to the installation instructions.

The hot water supply should be 70% of the capacity of the bath or greater. Installations will vary.

Provide one grounded electrical outlet within 24" (610 mm) of each component.

Remote blower installation kit K-1446 is available for relocating the blower. Provide access for servicing the blower.

Do not relocate or alter the PVC tee or coiled flexible tubing connected to the blower. Follow the blower relocation instructions exactly.

Required Electrical Service

One circuit required, protected with Class A Ground-Fault Circuit-Interrupter (GFCI). Outside North America, this device may be known as a Residual Current Device (RCD).

Blower: 120 V, 15 A, 60 Hz

Technical Information

All product dimensions are nominal.

Installation:	Drop-in
Drain location:	End
Basin area, bottom:	42" x 20" (1067 mm x 508 mm)
Basin area, top:	51" x 24" (1295 mm x 610 mm)
Weight:	84 lbs (38.1 kg)
Minimum floor load:	47 lbs/ft ² (229.5 kg/m ²)
Water depth:	14" (356 mm)
Water capacity:	60 gal (227.1 L)
Cutout:	Drop-in, 58" x 30" (1473 mm x 762 mm)
Electrical component rating:	Blower: 120 V, 10 A, 60 Hz
Minimum flat for door:	2-1/2" (64 mm)